

**Potpuno teleskopski izvlačni sistem,  
3 nivoa  
HEZ638370**

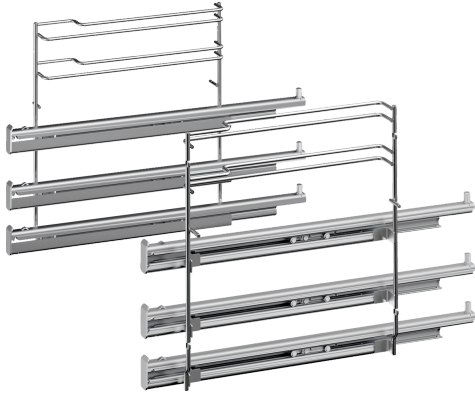

**Tehnički podaci**

Dimenzije zapakovanog aparata: ..... 50 x 430 x 475 mm  
Dimenzije palete: ..... 95.0 x 80.0 x 120.0  
Broj aparata na paleti: .....48  
Neto težina: ..... 3.2 kg  
Bruto težina: .....3.5 kg  
EAN kod: .....4242002810164



4 242002 810164