

**Series 4, Washing machine, front loader, 9 kg, 1400 rpm
WAN28259GB**



Washing machine with Iron Assist to reduce your ironing pile and with a long lasting EcoSilence Drive motor.

- **A rated:** save energy with our most efficient A rated appliances
- **Speed Perfect:** Cuts the cycle time by up to 65%* without compromising on results.
- **Iron Assist:** Reduces wrinkles and your ironing pile
- **Active Water Plus:** uses only the precise amount of water needed for every wash.
- **Reload function:** forgot an item? Add it easily to the wash.

Energy Efficiency Class: A
 Weighted energy consumption in kWh per 100 washing cycles of eco 40-60 programme: 49 kWh
 Maximum capacity in kg: 9.0 kg
 The water consumption of the eco programme in liters per cycle: 50 l
 Duration of eco 40-60 programme in hours and mins at rated capacity: 3:48 h
 Spin-drying efficiency class of eco 40-60 programme: B
 Airborne acoustical noise emission class: A
 Airborne acoustical noise emissions : 72 dB(A) re 1pW
 Built-in / Free-standing: Freestanding
 Dimensions of the product: 845x598x590 mm
 Net weight: 69.6 kg
 Connection rating: 2300 W
 Fuse protection: 10 A
 Voltage: 220-240 V
 Frequency: 50 Hz
 Length electrical supply cord: 210.0 cm
 Door hinge: Left
 Wheels: No
 EAN code: 4242005422203
 Installation typology: Free-standing

- WMZ2200 Floor securing component
 WMZ2381 Extension for cold water inlet /Aquastop
 WMZPW20W Platform with pull-out, washer, cubic



Series 4, Washing machine, front loader, 9 kg, 1400 rpm WAN28259GB

Washing machine with Iron Assist to reduce your ironing pile and with a long lasting EcoSilence Drive motor.

Performance

- Energy Efficiency Class¹: A
- Energy² / Water³: 49 kWh / 50 litres
- Load capacity: 1 - 9 kg
- Programme duration⁴: 3:48 h:min
- Spin drying efficiency class: B
- Spin speed^{**}: 0 - 1400 rpm
- Noise level: 72 dB (A) re 1 pW
- Noise efficiency class: A

Programmes/functions

- Standard programmes: cottons, easy care, delicates, wool hand wash
- Iron Assist: Steam programme that reduces wrinkles on dry clothes
- Special programmes: Outdoor, Shirts, Mixed Load, Super Quick 15/30, Drum clean with reminder, jeans/dark laundry, Wool/Handwash, Delicate/Silk programme

Key features

- SpeedPerfect: perfectly clean in up to 65% less time. ***
- Touch control buttons: Prewash, Ready in, Temperature selection, Night Wash / Silent Wash, SpeedPerfect, start/pause with reload function, Spin speed reduction

Additional features

- Reload function: Flexibility to add or remove laundry items of any size even after start of the wash cycle.
- Large display for spin speed, remaining time, 24 h end time delay and load recommendation
- Usage meter: counts completed programmes
- Drum volume: 65 litres
- Aqua Protection
- Fully electronic control dial for all wash and special programmes
- AntiVibration Design - for more stability and quietness
- EcoSilence drive with 10 year warranty
- EcoSilence drive with 10 year warranty
- ActiveWater Plus: for highly efficient use of water even with smaller loads thanks to automatic load detection.
- Foam detection system
- Safeguard monitoring system adjusts load distribution and programme settings to protect clothes
- No
- Buzzer to indicate the end of cycle
- Child lock
- Divider for Liquid Detergent
- Large silver-white door with 171° opening
- Metal door catch
- Reload facility

Technical Information

- Slide-under installation
- Dimensions (H x W): 84.5 cm x 59.8 cm
- Appliance depth: 59.0 cm
- Appliance depth incl. door: 63.3 cm
- Appliance depth with open door: 106.3 cm

¹ Scale of Energy Efficiency Classes from A to G

² Energy consumption in kWh per 100 cycles (in programme Eco 40-60)

³ Weighted water consumption in litres per cycle (in programme Eco 40-60)

⁴ Duration of Eco 40-60 programme

** Values are rounded.

*** Comparison between the program duration of Easy-care 40°C and the program duration of Easy-care 40°C + activated Speed option

**Series 4, Washing machine, front
loader, 9 kg, 1400 rpm
WAN28259GB**

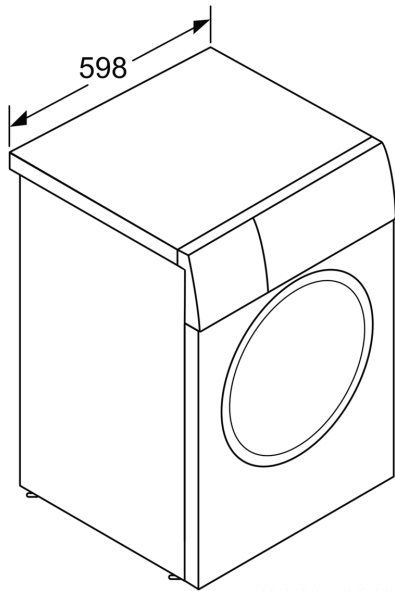

measurements in mm

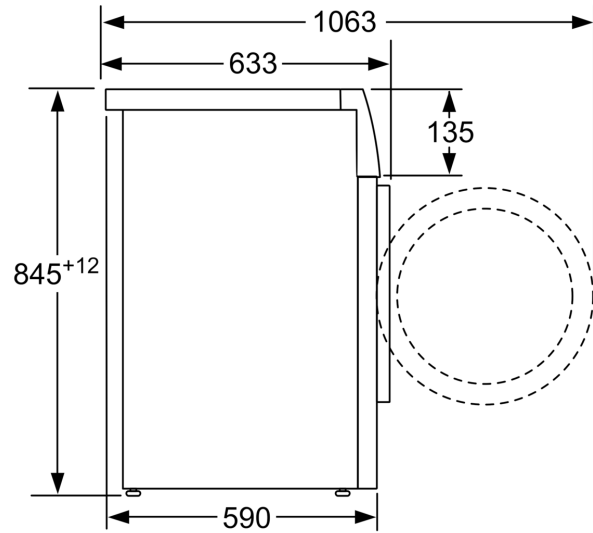

measurements in mm