

30" Downdraft

Downdraft Ventilation – Stainless Steel DHD3014UC



BOSCH
Invented for life



DHD3014UC
Stainless Steel

The perfect solution for high ceilings, islands, or simply for space considerations, our downdraft rises from behind your cooktop.

Features & Benefits

Allows you to adjust the performance of your hood to match the type of cooking.

The filter is concealed behind a stylish stainless steel cover to hide grease build up.

Flexible design gives the ability to recirculate the air back into the kitchen.

With the touch of the controls, chimney will automatically rise to over 13", and after use chimney lowers flush with the cooking surface.

600 CFM blowers available for remote, inline, and internal applications.

General Properties

Operating mode	Convertible: ducted / recirculating
Maximum CFM	Blower Sold Separately
Number of speed settings	3-stage
Motor location	External
Damper included	Yes
Grease filter material	Washable stainless steel
Grease filter type	Multilayer cassette

Technical Details

Volts (V)	120 V
Frequency (Hz)	60 Hz
Plug type	120V-3 prong
Power cord length (in.)	30"



Dimensions & Weight

Overall appliance dimensions (width of canopy included) (HxWxD) (in.)	21 5/8" x 31" x 3 3/4"
Height of the rise (in.)	13"
Diameter of air duct (in.) top	10"
Net weight (lbs)	37 lbs

Accessories—Optional



DHZDHR6
6" duct transition

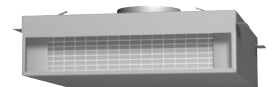

DHDRM36UC
Recirculation kit

NOTE: Required with the installation of inline and remote blowers for downdraft applications only. DHZDHR6 is for 600 CFM which will improve overall performance.



DHG601DUC
600 CFM Internal Blower



DHG6015NUC
600 CFM Inline Blower



DHG6023RUC
600 CFM Remote Blower

Accessories: To purchase Bosch accessories, cleaners & parts please visit www.bosch-home.com/us/store or call 1-800-944-2904 (Mon to Fri 5 am to 6 pm PST, Sat 6 am to 3 pm PST).

Notes: All height, width and depth dimensions are shown in inches. BSH reserves the absolute and unrestricted right to change product materials and specifications, at any time, without notice. Consult the product's installation instructions for final dimensional data and other details prior to making cutout.

Warranties: Please see Use & Care manual or Bosch website for statement of limited warranty.

For more information on our entire line of products, go to www.bosch-home.com/us or call 1-800-944-2904

© BSH Home Appliances Corporation. All rights reserved. Bosch is a registered trademark of Robert Bosch GmbH.

30" Downdraft

Downdraft Ventilation – Stainless Steel DHD3014UC

Installation Details

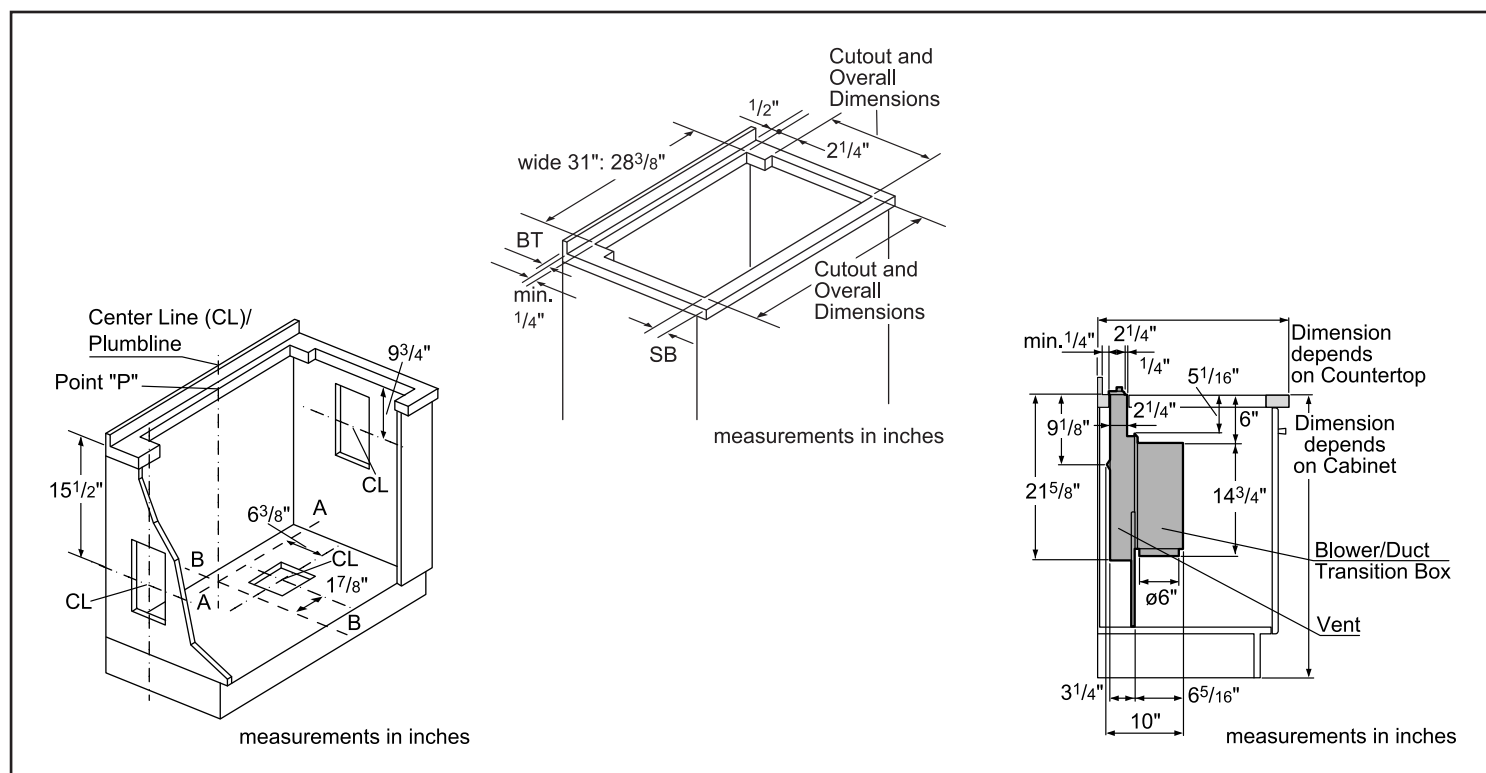
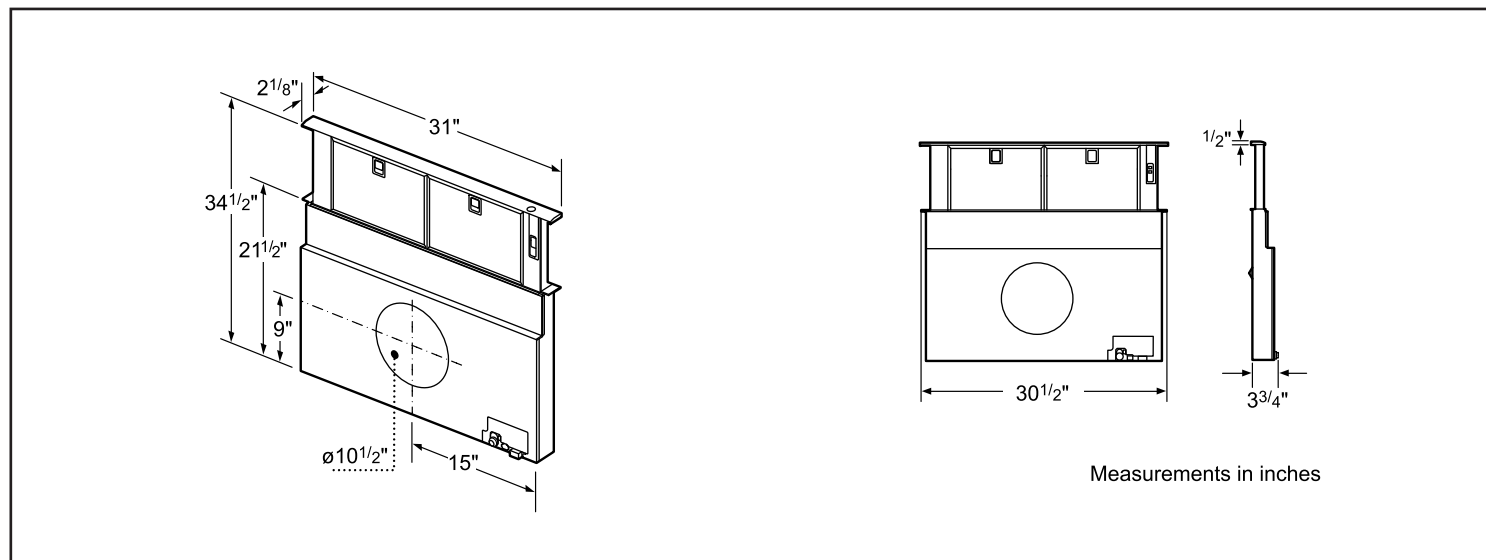

Accessories: To purchase Bosch accessories, cleaners & parts please visit www.bosch-home.com/us/store or call 1-800-944-2904 (Mon to Fri 5 am to 6 pm PST, Sat 6 am to 3 pm PST).

Notes: All height, width and depth dimensions are shown in inches. BSH reserves the absolute and unrestricted right to change product materials and specifications, at any time, without notice. Consult the product's installation instructions for final dimensional data and other details prior to making cutout.

Warranties: Please see Use & Care manual or Bosch website for statement of limited warranty.

For more information on our entire line of products, go to www.bosch-home.com/us or call 1-800-944-2904

© BSH Home Appliances Corporation. All rights reserved. Bosch is a registered trademark of Robert Bosch GmbH.