

COMBI-MICROWAVE OVEN

GM25.100 GM25.130

GAGGENAU



You can find additional information and explanations online.
Scan the QR code on the title page.



Table of contents

INFORMATION FOR USE		15 Programmes	25
1 Safety	2	16 Favourites	28
2 Preventing material damage	6	17 Core temperature probe	28
3 Environmental protection and saving energy	7	18 Home Connect	31
4 Familiarising yourself with your appliance	7	19 Basic settings	33
5 Functions in the Home Connect app	14	20 Cleaning and servicing	39
6 Accessories	14	21 Troubleshooting	42
7 Before using for the first time	15	22 Disposal	43
8 Basic operation	16	23 Customer Service	43
9 Microwave	18	24 How it works	44
10 Oven	19	25 Information regarding Free and Open Source Software	46
11 Combined operation	21	26 Declaration of Conformity	46
12 Timer functions	22	27 INSTALLATION INSTRUCTIONS	47
13 Long-term timer	24	27.1 Safe installation	47
14 Childproof lock	25		

1 Safety

Observe the following safety instructions.

1.1 Definition of the signal words

This is where you can find explanations for the safety signal words used in this manual.

WARNING

This indicates that death or serious injuries may occur as a result of non-observance of this warning.

ATTENTION

This indicates that damage to the appliance or other material damage may occur as a result of non-compliance with this warning.

Note: This alerts you to important information.

1.2 General information

- Read this instruction manual carefully.
- Keep the instruction manual and the product information safe for future reference or for the next owner.
- Do not connect the appliance if it has been damaged in transit.

1.3 Intended use

This appliance is designed only to be built into kitchen units. Read the special installation instructions.

Only a licensed professional may connect appliances without plugs. Damage caused by incorrect connection is not covered under the warranty.

The appliance can only be used safely if it is correctly installed according to the safety instructions. The installer is responsible for ensuring that the appliance works perfectly at its installation location.

Only use this appliance:

- To prepare meals and drinks.
- For household use and similar applications, such as: In kitchens for employees in shops, offices and other commercial sectors; in agriculture; by customers in hotels and other residential facilities; in bed and breakfasts.
- Up to an altitude of 4000 m above sea level.

This appliance complies with the standards EN 55011 and CISPR 11. It is a group 2, class B

product. Group 2 means that microwaves are produced for the purpose of heating food. Class B means that the appliance is suitable for private households.

1.4 Restriction on user group

This appliance may be used by children aged 8 or over and by people who have reduced physical, sensory or mental abilities or inadequate experience and/or knowledge, provided that they are supervised or have been instructed on how to use the appliance safely and have understood the resulting dangers.

Do not let children play with the appliance. Children must not perform cleaning or user maintenance unless they are at least 15 years old and are being supervised. Keep children under the age of 8 years away from the appliance and power cable.

1.5 Safe use

Always place accessories in the cooking compartment the right way round.

→ "Accessories", Page 14

⚠ WARNING – Risk of fire!

Combustible objects that are left in the cooking compartment may catch fire.

- ▶ Never store combustible objects in the cooking compartment.
- ▶ If smoke is emitted, the appliance must be switched off or the fuse must be switched off and the door must be held closed in order to stifle any flames.

Loose food remnants, fat and meat juices may catch fire.

- ▶ Before using the appliance, remove the worst of the food residues and remnants from the cooking compartment, heating elements and accessories.

Opening the appliance door creates a draught. Greaseproof paper may come into contact with the heating element and catch fire.

- ▶ Never place greaseproof paper loosely over accessories when preheating the appliance and while cooking.
- ▶ Always cut greaseproof paper to size and use a plate or baking tin to hold it down.

⚠ WARNING – Risk of burns!

The appliance and its parts that can be touched become hot during use.

- ▶ Caution should be exercised here in order to avoid touching heating elements.

- ▶ Young children under 8 years of age must be kept away from the appliance.

Accessories and cookware get very hot.

- ▶ Always use oven gloves to remove accessories or cookware from the cooking compartment.

When the cooking compartment is hot, any alcoholic vapours inside may catch fire. The appliance door may spring open. Hot steam and jets of flame may escape.

- ▶ Only use small quantities of drinks with a high alcohol content in food.
- ▶ Do not heat spirits ($\geq 15\%$ vol.) when undiluted (e.g. for marinating or pouring over food).
- ▶ Open the appliance door carefully.

The inside of the appliance door becomes very hot during operation.

- ▶ During or after operation of the appliance, only touch the appliance door at the surface intended for this on the side.
- ▶ Always open the appliance door as far as it will go.

⚠ WARNING – Risk of scalding!

The accessible parts of the appliance become hot during operation.

- ▶ Never touch these hot parts.
- ▶ Keep children at a safe distance.

Hot steam may escape when you open the appliance door. Steam may not be visible, depending on the temperature.

- ▶ Open the appliance door carefully.
- ▶ Keep children at a safe distance.

If there is water in the cooking compartment when it is hot, this may create hot steam.

- ▶ Never pour water into the cooking compartment when the cooking compartment is hot.

⚠ WARNING – Risk of injury!

Scratched glass in the appliance door may develop into a crack.

- ▶ Do not use any harsh or abrasive cleaners or sharp metal scrapers to clean the glass on the appliance door, as they may scratch the surface.

The hinges on the appliance door move when the door is opened and closed, which could trap your fingers.

- ▶ Keep your hands away from the hinges.

The light emitted by LED lights is very dazzling, and can damage the eyes (risk group 1).

- ▶ Do not look directly into the switched on LED lights for longer than 100 seconds.

⚠ WARNING – Risk of electric shock!

Improper repairs are dangerous.

- ▶ Repairs to the appliance should only be carried out by trained specialist staff.
- ▶ Only use genuine spare parts when repairing the appliance.
- ▶ If the power cord or the appliance power cable of this appliance is damaged, it must be replaced with a special power cord or special appliance power cable, which is available from the manufacturer or its Customer Service.
- ▶ If the power cord of this appliance is damaged, it must be replaced by trained specialist staff.

If the insulation of the power cord is damaged, this is dangerous.

- ▶ Never let the power cord come into contact with hot appliance parts or heat sources.
- ▶ Never let the power cord come into contact with sharp points or edges.
- ▶ Never kink, crush or modify the power cord.

An ingress of moisture can cause an electric shock.

- ▶ Do not use steam- or high-pressure cleaners to clean the appliance.

If the appliance or the power cord is damaged, this is dangerous.

- ▶ Never operate a damaged appliance.
- ▶ Never operate an appliance with a cracked or fractured surface.
- ▶ If the glass of the lighting is damaged, switch off the appliance to avoid a possible electric shock.
- ▶ If the appliance or the power cable is damaged, immediately switch off the fuse in the fuse box.
- ▶ Call customer service. → *Page 43*

⚠ WARNING – Risk of suffocation!

Children may put packaging material over their heads or wrap themselves up in it and suffocate.

- ▶ Keep packaging material away from children.
- ▶ Do not let children play with packaging material.

Children may breathe in or swallow small parts, causing them to suffocate.

- ▶ Keep small parts away from children.
- ▶ Do not let children play with small parts.

1.6 Microwave

CAREFULLY READ THE IMPORTANT SAFETY INSTRUCTIONS AND KEEP THEM SAFE FOR FUTURE USE

⚠ WARNING – Risk of fire!

Using the appliance for anything other than its intended purpose is dangerous and may cause damage. For example, heated slippers and pillows filled with grain or cereal may catch fire, even several hours later.

- ▶ Never dry food or clothing with the appliance.
- ▶ Never heat up slippers, pillows filled with grain or cereal, sponges, damp cleaning cloths or similar with the appliance.
- ▶ The appliance must only be used to prepare food and drink.

Food and its packaging and containers may catch fire.

- ▶ Never heat food in heat-retaining packaging.
- ▶ Do not leave food unattended while it is heating in containers made of plastic, paper or other combustible materials.
- ▶ Never set the microwave power too high or the cooking time too long. Follow the instructions provided in this user manual.
- ▶ Never use the microwave to dry food.
- ▶ Never defrost or heat food with a low water content, such as bread, at too high a microwave power or for too long.

Cooking oil may catch fire.

- ▶ Never use the microwave to heat cooking oil on its own.

Objects and utensils that are left in the microwave oven may catch fire.

- ▶ Before using the appliance, make sure that there are no objects or utensils in the cooking compartment that are not suitable for use in a microwave oven.
- ▶ Do not use the cooking compartment to store combustible objects, cooking utensils, food or similar when the microwave oven is not in use.

⚠ WARNING – Risk of explosion!

Liquids and other food may easily explode when in containers that have been tightly sealed.

- ▶ Never heat liquids or other food in containers that have been tightly sealed.

⚠ WARNING – Risk of burns!

Foods with peel or skin may burst or explode during heating, or even afterwards.

- ▶ Never cook eggs in their shell or heat hard-boiled eggs in their shell.
- ▶ Never cook shellfish or crustaceans.
- ▶ Always prick the yolk of eggs before microwaving.
- ▶ The skin of foods that have a peel or skin, such as apples, tomatoes, potatoes and sausages, may burst. Before heating, prick the peel or skin.

Heat is not distributed evenly through baby food.

- ▶ Never heat baby food in closed containers.
- ▶ Always remove the lid or teat.
- ▶ Stir or shake well after heating.
- ▶ Check the temperature before giving the food or drink to a child.

Heated food gives off heat. The cookware may become hot.

- ▶ Always use oven gloves to remove cookware or accessories from the cooking compartment.

Airtight packaging may burst when food is heated.

- ▶ Always follow the instructions on the packaging.
- ▶ Always use oven gloves to remove the dishes from the cooking compartment.

The accessible parts of the appliance become hot during operation.

- ▶ Never touch these hot parts.
- ▶ Keep children at a safe distance.

Using the appliance for anything other than its intended purpose is dangerous. This is because, for instance, overheated slippers, pillows filled with grain or cereal, sponges and damp cleaning cloths, etc., may cause burns to the skin.

- ▶ Never dry food or clothing with the appliance.
- ▶ Never heat up slippers, pillows filled with grain or cereal, sponges, damp cleaning cloths or similar with the appliance.
- ▶ The appliance must only be used to prepare food and drink.

⚠ WARNING – Risk of scalding!

There is a possibility of delayed boiling when a liquid is heated. This means that the liquid reaches the boiling temperature without the usual steam bubbles rising to the surface. Exercise caution even when only gently shaking

the container. The hot liquid may suddenly boil over and splatter.

- ▶ Always place a spoon in the container when heating liquids. This prevents delayed boiling.

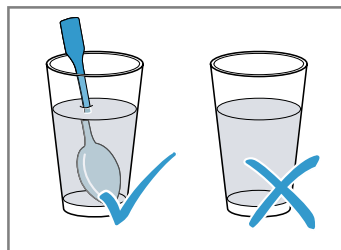
**⚠ WARNING – Risk of injury!**

Unsuitable cookware may crack. Porcelain or ceramic cookware can have small perforations in the handles and lid. These perforations conceal a cavity below. If moisture penetrates this cavity, it could cause the cookware to crack.

- ▶ Only use microwave-safe cookware. Cookware and containers made from metal or cookware with metal edging may lead to sparks being formed during simple microwave operation. The appliance is damaged.
- ▶ Never use metal containers during microwave-only operation.
- ▶ Only use microwave-safe cookware or use the microwave in combination with a type of heating.

⚠ WARNING – Risk of electric shock!

The appliance uses a high voltage.

- ▶ Never remove the casing.

⚠ WARNING – Risk of serious harm to health!

Inadequate cleaning may destroy the surface of the appliance, reduce its service life, and lead to dangerous situations, such as escaping microwave energy.

- ▶ Clean the appliance on a regular basis, and remove any food residue immediately.
- ▶ Always keep the cooking compartment, door seal, door and hinge clean.

→ "Cleaning and servicing", Page 39

⚠ WARNING – Risk of harm to health!

Never operate the appliance if the cooking compartment door is damaged. Microwave energy may escape.

- ▶ Never use the appliance if the cooking compartment door or the door seal is damaged.
- ▶ Any repair work must only be carried out by customer service.

⚠ WARNING – Risk of serious harm to health!

Microwave energy will escape from appliances that do not have any casing.

- ▶ Never remove the casing.
- ▶ For any maintenance or repair work, contact the customer service.

1.7 Core temperature probe

Follow these safety instructions when using the core temperature probe.

⚠ WARNING – Risk of electric shock!

An incorrect core temperature probe may damage the insulation.

- ▶ Only use the core temperature probe that is suitable for this appliance.

⚠ WARNING – Risk of injury!

The core temperature probe is sharp.

- ▶ Handle the core temperature probe with care.

2 Preventing material damage

2.1 General

ATTENTION

Alcoholic vapours may catch fire in the hot cooking compartment and cause permanent damage to the appliance. The appliance door may spring open due to an explosion and it may fall off. The door panels may shatter and fragment. Due to the resulting negative pressure, the cooking compartment may become considerably deformed inwards.

- ▶ Do not heat spirits ($\geq 15\%$ vol.) when undiluted (e.g. for marinating or pouring over food).

When the cooking compartment is hot, any water inside it will create steam. The change in temperature may cause damage.

- ▶ Never pour water into the cooking compartment when it is still hot.

Carrying the appliance by the appliance frame may cause it to bend. The appliance frame cannot support the weight of the appliance.

- ▶ Never operate the appliance if the seal is damaged or missing.

Sitting or placing objects on the appliance door may damage it.

- ▶ Do not place, hang or support objects on the appliance door.
- ▶ Do not place cookware or accessories on the appliance door.

2.2 Microwave

Follow these instructions when using the microwave.

ATTENTION

Metal touching the wall of the cooking compartment will cause sparks, which may damage the appliance or the inner door pane.

- ▶ Metal (e.g. a spoon in a glass) must be kept at least 2 cm from the cooking compartment walls and the inside of the door.

Placing aluminium containers in the appliance may cause sparks, which will damage the appliance.

- ▶ Do not use aluminium containers in the appliance.

Operating the appliance without food in the cooking compartment may lead to overloading.

- ▶ Do not switch on the microwave unless there is food inside. The only exception to this rule is when performing a short cookware test.

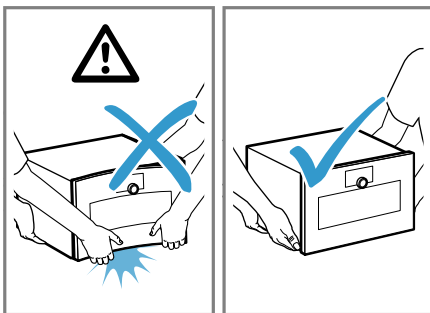

- ▶ Do not lift the appliance using the appliance frame.
- ▶ Always lift the appliance at the casing.

The prolonged presence of moisture in the cooking compartment leads to corrosion.

- ▶ Always wipe away the condensation after cooking. Always allow the cooking compartment to cool down with the door closed after cooking at high temperatures.

- ▶ Do not keep moist food in the cooking compartment for a long time with the door closed.

- ▶ Do not store food in the cooking compartment.

- ▶ Take care not to trap anything in the appliance door.

If the seal is very dirty, the appliance door will no longer close properly during operation. This may damage the front of adjacent kitchen units.

- ▶ Keep the seal clean at all times.

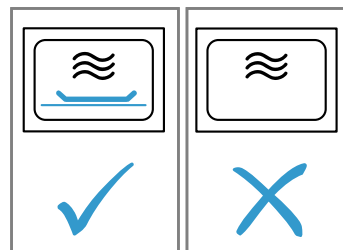

If you prepare several bags of microwave popcorn in immediate succession at a microwave power level that is too high, the cooking compartment may be damaged.

- ▶ Leave the appliance to cool down for several minutes between each use.

- ▶ Never set a microwave power level that is too high.

- ▶ Use a maximum microwave output of 600 watts.

- ▶ Always place the popcorn bag on a glass plate or on the cooking compartment floor.

Using unsuitable cookware may result in damage.

- ▶ When using the grill, the microwave combi mode or the hot air, only use tableware that can withstand the high temperatures.

Loose knurled screws may cause sparks to form during microwave operation.

They damage the appliance by producing sparks.

- ▶ Ensure that the knurled screws for installing the shelf supports are screwed in tightly.

2.3 Core temperature probe

⚠ WARNING – Risk of electric shock!

An incorrect core temperature probe may damage the insulation.

- ▶ Only use the core temperature probe that is suitable for this appliance.

ATTENTION

You may damage the cable of the core temperature probe with the appliance door.

- ▶ Do not trap the cable of the core temperature probe in the appliance door.

The heat of the grill heating element may damage the core temperature probe.

- ▶ Ensure that the distance between the grill heating element and the core temperature probe and the cable of the core temperature probe is a few centimetres. In doing so, ensure that the meat can expand during the cooking process.

Aggressive cleaning agents may damage the core temperature probe.

- ▶ Do not clean the core temperature probe in the dishwasher.

3 Environmental protection and saving energy

3.1 Disposing of packaging

The packaging materials are environmentally compatible and can be recycled.

- ▶ Sort the individual components by type and dispose of them separately.

3.2 Saving energy

If you follow these instructions, your appliance will use less power.

Use dark-coloured, black-coated or enamelled baking tins.

- ✓ These types of baking tin absorb the heat particularly well.

Only preheat the appliance if the recipe or the recommended settings tell you to do so.

- ✓ Not preheating the appliance can reduce the energy used.

When cooking multiple dishes, do so in succession or in parallel.

- ✓ The cooking compartment is heated after cooking the first dish. This reduces the cooking time for the following dishes.

Open the appliance door as little as possible during operation.

- ✓ This will maintain the temperature in the cooking compartment and eliminate the need for the appliance to reheat.

If the cooking time is relatively long, you can switch the appliance off 10 minutes before the cooking time ends.

- ✓ There will be enough residual heat to finish cooking the dish.

4 Familiarising yourself with your appliance

4.1 Appliance

You can find an overview of the parts of your appliance here.

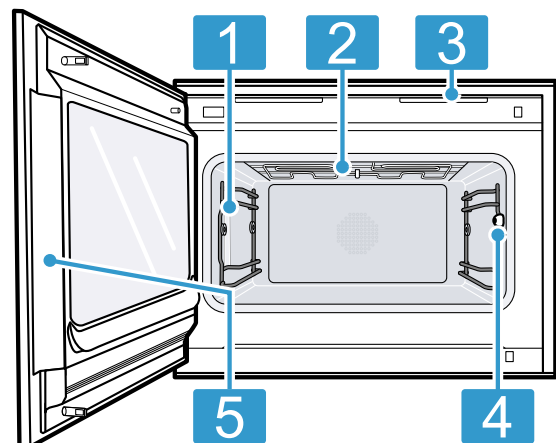

1 Interior lighting

- 2** Grill element
- 3** Ventilation slots
- 4** Connection socket for core temperature probe
→ Page 28
- 5** Intended surface for opening the door

4.2 Cooking compartment

The cooking compartment has two shelf levels. Count the shelf levels from the bottom up.

ATTENTION

The accessories may tip.

- ▶ Do not push the accessories between the shelf positions.

Use shelf level 1 for deeper baking tins.

You can also remove the shelf supports → Page 40 and cook on the cooking compartment floor.

The cooking compartment floor is particularly suitable for microwave operation. The microwave output is best on the cooking compartment floor. Only use microwave-safe cookware.

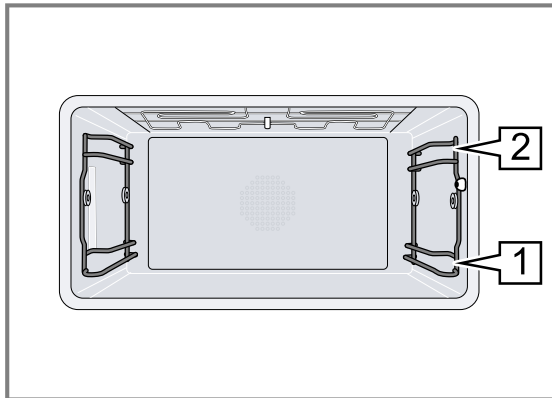

Interior lighting

When you open the appliance door, the interior lighting switches on. If the appliance door remains open for longer than 3 minutes, the appliance switches the interior lighting off.

⚠ WARNING – Risk of injury!

The light emitted by LED lights is very dazzling, and can damage the eyes (risk group 1).

- ▶ Do not look directly into the switched on LED lights for longer than 100 seconds.

You can also switch on the interior lighting when the appliance is in low power mode.

After approx. 20 minutes, the appliance switches the interior lighting off.

When you switch on the appliance, the appliance switches the interior lighting on.

→ "Switching the interior lighting on or off", Page 17

In most operating modes, the appliance keeps the interior lighting switched on.

You can specify whether the appliance will switch the interior lighting on during operation in the basic settings → Page 33. If you select the "Manual" setting in the basic settings, the appliance does not switch on the interior lighting automatically but you can switch on the interior lighting when required. After approx. 20 seconds, the appliance switches the interior lighting off.

terior lighting when required. After approx. 20 seconds, the appliance switches the interior lighting off.

Condensation

Condensation can occur in the cooking compartment and on the appliance door when cooking. Condensation is normal and does not adversely affect appliance operation. Wipe away the condensation after cooking.

4.3 Control elements

You can use the control panel to configure all functions of your appliance and to obtain information about the operating status.

On certain models, specific details may differ from those pictured.

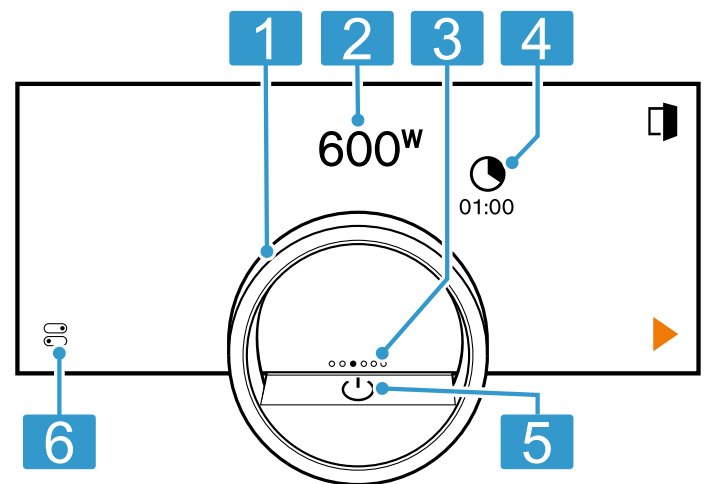

- | | |
|--------------------------------------|---|
| 1 Control ring | Use the control ring to change the selection. |
| 2 12 o'clock position | The 12 o'clock position shows the value that is currently selected for a function, which you can change using the control ring. If required, press on another function, e.g. on the temperature or cooking time, to position this at the 12 o'clock position. |
| 3 Position indicator | The filled point on the display in the middle of the control ring shows the current horizontal navigation position between the appliance displays. |
| 4 Symbols | Show settings and start or end functions. |
| 5 On/Off button | Switch the appliance on and off. |
| 6 Status bar & Control centre | The status line shows the current status of functions or appliance components, e.g.: <ul style="list-style-type: none"> ■ Home Connect connection status ■ Childproof lock Press to open the control centre → Page 11. |

Control ring

Operation using the control ring is only possible when the appliance is switched on. You can use the control

ring to navigate through the ring menus or the list menus and select settings. When you touch the control ring, the display shows a ring in orange behind the control ring.

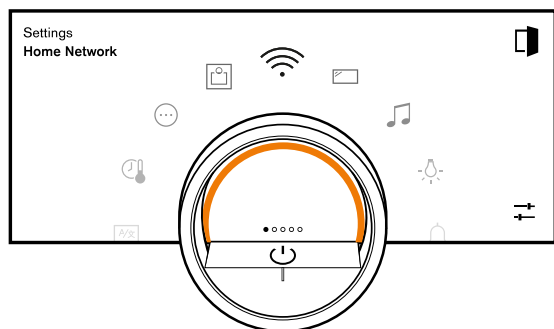

While operating the appliance, you can only use the control ring if you first select a function on the display.

Turn	<p>Navigate in ring menus and list menus:</p> <ul style="list-style-type: none"> Turn the control ring to the right to increase the values. Turn the control ring to the left to decrease the values. Turn the control ring to the right or left quickly to change the values in larger increments.
------	--

You can set how the control ring behaves in the basic settings → *Page 33*. In the "Standard" setting, press on the required function on the display and use the control ring to change the value of the function.

In the "Quick selection" setting, use the control ring, which is at the 12 o'clock position, to directly change the values for the function.

Process visualisation

For process visualisation, the appliance shows a section of a circle in orange behind the control ring.

The appliance shows the section of a circle in orange under the following conditions:

- A cooking time is set.
- A core temperature is set for the core temperature probe.

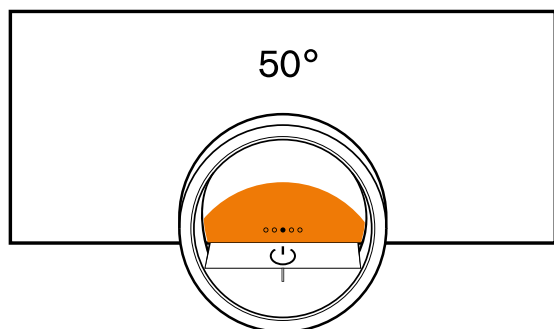

The section of the circle in orange becomes larger, the longer the timer runs or the closer the core temperature of the food approaches the set core temperature. If no cooking time and no core temperature are set, the section of the circle pulsates in orange.

Display

The display shows the selected settings and setting options, as well as messages about the appliance's operating status.

Press	Selects or confirms the procedure or function
Press and hold	Displays additional information
Swipe horizontally	<p>Navigates between appliance displays</p> <p>For example, in the "Microwave" appliance display, swipe to the left or right</p> <p>Note: You can only use the function if you are in an appliance display → <i>Page 10</i> and no programme is running.</p>

Note: If no display language is available in your national language, select a display language that is available, e.g. English.

Symbols

Use the symbols to start or stop functions, or to navigate in the appliance menu.

Operation

Symbol	Function
	Switching the appliance on or off at the control ring
	Opening the appliance door → <i>Page 16</i>
	Opening the control centre → <i>Page 17</i>
	Edit settings
	Call up additional information → <i>Page 17</i>
	Saving a favourite → " <i>Favourites</i> ", <i>Page 28</i>
	Editing a favourite
	Deleting a favourite
	Calling up tips for programmes → <i>Page 25</i>
	Start
Max.	Selecting the maximum microwave output
	Pause or stop
	Switch to the next step
	Switch to the previous step
	Back or accept settings
	Continue
	Confirm
	Delete
	Reset
	Cancel
	Adding → <i>Page 21</i> or deleting microwave operation → <i>Page 21</i>
	Turning on the grill

Timer functions

Symbol	Function
	Calling up the timer menu → <i>Page 22</i>
	Call up the long-term timer → <i>Page 24</i>
	Deleting the heating cycle from the long-term timer → <i>Page 25</i>
	Delaying the cooking time end → <i>Page 23</i>
	Resetting the cooking time to the preset cooking time → <i>"Changing the cooking time", Page 22</i> Reset the delay of the cooking time end → <i>"Resetting the delay of the cooking time end", Page 23</i>

Cleaning and servicing

Symbol	Function
	Cleaning aid → <i>Page 40</i>

Operation in the control center

Symbol	Function
	Opening the appliance door automatically after the cooking process → <i>Page 17</i>
	Activating the childproof lock → <i>Page 25</i>
	Switching the interior lighting on or off → <i>Page 17</i>
	Start functions with the Home Connect app via manual "Remote start" → <i>"Starting functions with the Home Connect app via manual 'Remote start'", Page 32</i>

Appliance displays

You can find an overview of the appliance displays here.

Appliance displays	Use	Position indicator
Settings	<ul style="list-style-type: none"> Adjusting the basic settings → <i>Page 33</i> Adjusting the Home Connect settings → <i>Page 31</i> 	●○○○○○
Modes & Service	<ul style="list-style-type: none"> Starting the cleaning aid → <i>Page 40</i> Starting the quick guide → <i>Page 17</i> 	○●○○○○
Microwave	Setting the microwave output → <i>Page 18</i> and cooking time → <i>Page 22</i>	○○●○○○
"Manual" (oven mode, combined operation)	Setting the type of heating, microwave activation → <i>Page 18</i> and cooking time → <i>Page 22</i>	○○○●○○
Favourites	Calling up favourites → <i>Page 28</i>	○○○○●○
Programmes	Calling up automatic programmes and setting recommendations → <i>Page 25</i>	○○○○○●

Tip: In the basic settings → *Page 33*, you can set which appliance menu your appliance starts in.

Symbol	Function
	Home Connect Call up settings → <i>"Home ConnectSettings", Page 32</i>

Status

	Remote start → <i>Page 32</i>
	Core temperature sensor is inserted → <i>"Core temperature probe", Page 28</i>
	Core temperature probe is missing
	Status display for the heating process
	Display of a cooling process
	The appliance is in demo mode → <i>Page 43</i>

Status in the control centre

Symbol	Function
	Connection to the router: Strong → <i>"Home Connect ", Page 31</i>
	Connection to the router: Ok → <i>"Home Connect ", Page 31</i>
	Connection to the router: Weak → <i>"Home Connect ", Page 31</i>
	No connection to the router. → <i>"Home Connect ", Page 31</i>
	Appliance connected to the router. No connection to the Home Connect server. → <i>"Home Connect ", Page 31</i>
	Software update status

Colours

The different colours are used to guide the user in the relevant setting situations.

red	<ul style="list-style-type: none"> ▪ Error messages for which you may need the help of customer service.
orange	<ul style="list-style-type: none"> ▪ Information that you must observe so that you can continue to use your appliance ▪ Symbols for starting and stopping
White	<ul style="list-style-type: none"> ▪ Information ▪ Additional information

Appearance

Depending on the situation, the appearance of symbols, values or the entire display changes.

Zooming in ring menus and list menus	When you use the control ring to select a list entry in a list menu, the display enlarges this list entry and displays it as underlined. When you use the control ring to select a value in a ring menu, the display shows this value enlarged in the 12 o'clock position.
Zoom at end of cooking or core temperature probe	A few minutes before the cooking process ends, the appliance shows the remaining cooking time enlarged in the centre of the display. As soon as the current core temperature is just a few degrees below the set value, the display shows the current core temperature enlarged.

All other displays are hidden.

Pared-down display

If the appliance does not detect a user in the immediate vicinity, the appliance reduces the amount of information shown on the display and only the most important information remains. This function is preset. You can change the setting in the basic settings → *Page 33*.

Control centre

The control centre  provides you with access to functions that are only visible in the status bar via symbols. You can activate or deactivate functions in the control centre.

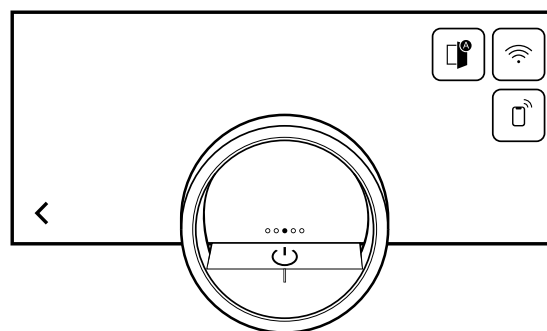

On the left-hand side, the display shows the symbols and texts with information on the current status of the appliance. On the right-hand side, the display shows the touch fields of the control centre.









4.4 Types of heating

Here you can find an overview of the functions. You will find recommendations for using the types of heating.

Microwave function



Symbols	Function	power	Application
90	Microwave	90 W	Defrost delicate foods.
180	Microwave	180 W	Defrost foods.
360	Microwave	360W	Defrost foods or cook gently.
450	Microwave	450 W	Cook foods or warm up gently.
600	Microwave	600 W	Cook or warm up foods.
Max.	Microwave	1000 W	Quickly heat liquids When the appliance is cold, the full microwave output of 1000 W is available.

Oven functions

Symbols	Function/type of heating	Temperature/setting	power	Application
	Hot air	30-230 °C		The heat arises from the back wall of the cooking compartment and is distributed quickly and evenly by the fan. For cooking on one or two levels with an extremely short preheating time. For moist cakes, biscuits, bakes. To reduce the cooking time, the microwave can be switched on.
	Grill + circulated air	30-230 °C		Extremely intensive heat from above, which is distributed quickly and evenly by the fan. Guarantees that a crust is formed with simultaneous all-round heating. For meat, poultry, fish, vegetable skewers. No preheating is required. To reduce the cooking time, the microwave can be switched on.
	Dehydrating	30-80 °C		For drying thin slices of fruit or vegetables or herbs. Moisture is actively extracted from the cooking compartment.
	Low temperature cooking	30-90 °C	90 W	Slow and gentle cooking of meat for a particularly tender result. Hot air is combined with a low microwave output in order to reduce the cooking time. Briefly sear meat before cooking.
	Dough proving	30-50 °C		Optimal temperature range for proving dough batches and pieces of dough. For yeast and sourdough. The optimal temperature setting for yeast dough is 38 °C.
	Keeping warm		50 W	Optimal microwave output for keeping food warm without it drying out.
	Defrosting		90-360 W	Optimal microwave output range for quickly and gently defrosting frozen food. Use 90 W for delicate foods.
	Warming up beverages		max.	Optimal microwave output for quickly heating liquids such as water and milk.
	Warming up meals		360-600 W	Optimal microwave output range for heating up cooked meals, such as plated meals, bakes and soups.

MicroCombi function

You can add the microwave function for the following types of heating.

Symbols	Function	Temperature/setting	Application
	Hot air	30-230 °C	The heat arises from the back wall of the cooking compartment and is distributed quickly and evenly by the fan. For cooking on one or two levels with an extremely short preheating time. For moist cakes, biscuits, bakes. To reduce the cooking time, the microwave can be switched on.
	Grill + circulated air	30-230 °C	Extremely intensive heat from above, which is distributed quickly and evenly by the fan. Guarantees that a crust is formed with simultaneous all-round heating. For meat, poultry, fish, vegetable skewers. No preheating is required. To reduce the cooking time, the microwave can be switched on.

4.5 Low power mode display

The appliance has different displays in low power mode. The displays depend on whether or not the appliance detects a user.

On the display without user detection, the appliance is switched off and the display is black. The appliance switches to low power mode without user detection if, when the appliance is switched on, you do not implement any settings for approx. 20 minutes or approx. 20 minutes after the appliance has completed a heating process.

If the proximity sensor detects a user or if you touch the control ring or press on the display, the appliance switches to low power mode with user detection.

In low power mode with user detection, the display shows the door opening symbol and the status bar. In the basic settings → *Page 33*, you can select whether the display also shows the GAGGENAU logo.

If the appliance is connected to the Home Connect app, the display shows .

→ *"Home Connect", Page 31*

The user detection distance depends on the selected basic settings.

In low power mode with user detection, the display brightness is reduced. The brightness of the display depends on the viewing angle.

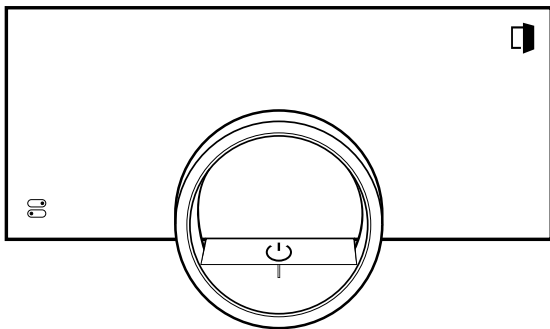

4.6 Cooling fan

The cooling fan switches on when the appliance is in operation. The hot air escapes above the door. After removing your food from the appliance, keep the door closed until the appliance has cooled down. The

appliance door should not be left half open as this may damage adjacent kitchen units. The cooling fan continues running for a certain period of time after the appliance has stopped heating and then it switches itself off automatically.

Do not cover the ventilation slots. Otherwise, the appliance will overheat.

4.7 Additional information

If required, you can display additional information.

When you press on , the display shows additional information about the current function.

When you press and hold certain symbols or values, the display shows additional information about the current function. Additional information is available for all symbols that are arranged around the control ring, e.g. information about the set type of heating or current interior temperature.

In the basic settings → *Page 33*, you can activate or deactivate the "Info-i" function.

The appliance also occasionally displays important information about safety and the operating status automatically. These messages disappear automatically after a few seconds, or when you press  to confirm the message.

For messages about Home Connect, the appliance also displays the Home Connect status.

→ *"Home Connect", Page 31*

4.8 Pop-up information

Pop-up messages contain explanations about current functions.

In the basic settings → *Page 33*, you can activate or deactivate the "Pop-up hints" function.

4.9 Quick guides

Your appliance comes with a quick guide to help you with various topics.

4.10 Automatic switch-off

For your protection, the appliance is equipped with an automatic switch-off function. The appliance switches off every heating process after a certain amount of time if you do not operate the appliance or program a cooking

time during this time. For types of heating without the microwave, the appliance switches off the heating process after 12 hours, and for types of heating with the microwave, after 90 minutes. If you use the maximum microwave output level, the appliance switches off the heating process after 30 minutes. The display shows a message.

If you set a cooking time, you can use the appliance for longer.

If you set a cooking time, you can operate the appliance in the "Hot air", "Grill + circulated air", "Low temperature cooking" or "Dough proving" type of heating for a maximum of 24 hours. With the "Dehydrating" type of heating, you can operate the appliance for a maximum of 72 hours.

When programming with the long-term timer → *Page 24* function, the appliance switches off after up to 74 hours.

4.11 Proximity sensor

Your appliance detects whether you are in front of the appliance or moving towards it. Your appliance disregards if you are passing in front of it.

If you do not remain in the detection zone for the appliance when it is switched on, the appliance reduces the display to what is essential.



Note: You can set the distance at which the appliance can detect you in the basic settings. To ensure that the proximity sensor optimally detects the user, set the installation height of the appliance's upper edge in the basic settings → *Page 33*.

4.12 Wipe protection

Your appliance detects if you would like to clean the display or navigate between the appliance displays. The appliance locks the operation via the display and the control ring for a short time.

Press the display to return to the operation.

4.13 Door lock

The "Door lock" function prevents the appliance door from being opened accidentally. This is particularly useful when installing the appliance under the worktop. In the basic settings → *Page 33*, you can activate or deactivate the "Door lock" function. When you activate the function and press , the display shows a slide control instead of the  symbol.

→ *"Opening the appliance door", Page 16*

5 Functions in the Home Connect app

The Home Connect app offers a range of functions and benefits.

- Monitor the cooking process, e.g. the remaining cooking time or the current core temperature.
- Start or stop a type of heating or program, or change the settings.
- Run important updates to the appliance software.
- Find the optimum settings or the optimum program for your recipe with the Oven Assistant function.
- When using the core temperature probe, obtain an estimate of the remaining cooking time.
- Change the basic settings for the appliance.
- Operate the main functions via Voice Control (using Alexa or Google Home).
- Find the appliance information and instructions.
- Find new recipes.

6 Accessories

Use original accessories. These have been made especially for your appliance. The accessories supplied may differ depending on the appliance model.

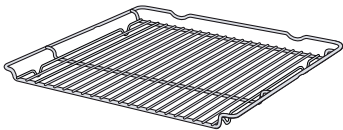
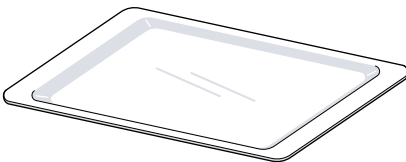
Accessories	Use
Wire rack	 <ul style="list-style-type: none"> ▪ Cookware ▪ Cake tins ▪ Grilled items ▪ Frozen meals ▪ Microwave-safe <p>Tip: You can pull the wire rack $\frac{2}{3}$ of the way out without it tipping. You can therefore remove meals more easily.</p>
Glass tray	 <ul style="list-style-type: none"> ▪ Large roasts ▪ Moist cakes ▪ Bakes ▪ Gratins ▪ Splash guard when grilling directly on the wire rack <p>When grilling, slide the glass tray in at level 1.</p> <ul style="list-style-type: none"> ▪ Microwave-safe

Accessories

Use

Tip: You can use the glass tray as a setdown area during microwave operation. When the appliance is in microwave-only mode, you can also place the glass tray on the cooking compartment floor.

6.1 Other accessories

You can purchase other accessories from our customer service, specialist retailers or online.

You will find a comprehensive range of products for your appliance in our brochures and online:

www.gaggenau.com

Accessories are appliance-specific. When purchasing accessories, always quote the exact product number (E no.) of your appliance.

You can find out which accessories are available for your appliance in our online shop or from our customer service.

Other accessories	Order number
Core temperature probe	BA010050
Glass tray	BA046118
Wire rack	BA036106
Manual door opening aid	

6.2 Sliding accessories into the cooking compartment

The wire rack is equipped with a catch that prevents it from tipping when it is pulled out. To ensure that the tilt protection works correctly, the wire rack must always be inserted into the cooking compartment the right way round.

ATTENTION

The accessories may tip.

- ▶ Do not push the accessories between the shelf positions.

1. When inserting the wire rack, ensure that the lug  is facing downwards.

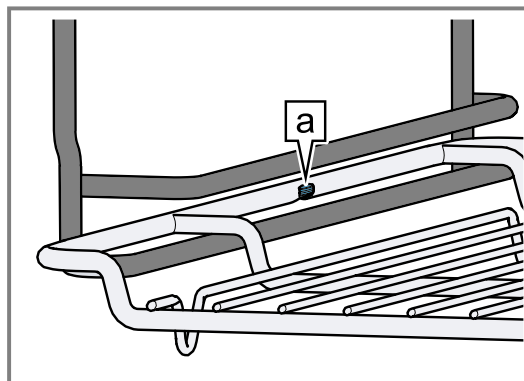

2. Ensure that the safety bracket on the wire rack  is located at the rear and is facing upwards.

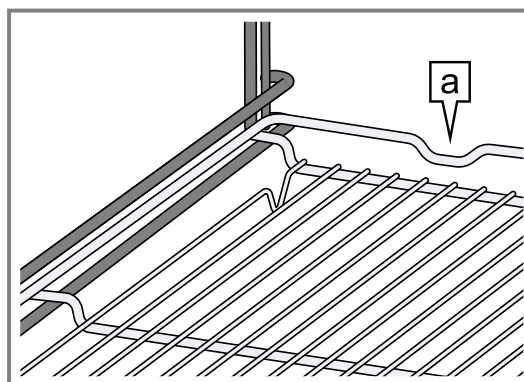

Note: To remove it completely, lift the wire rack slightly and pull it out with both hands.

Remove any accessories that you do not require from the cooking compartment.

7 Before using for the first time

Configure the settings for initial start-up. Clean the appliance and accessories.

7.1 Initial start-up

Implement the settings for initial use before using your appliance.

First read the information under safety → *Page 2*.

The appliance must be installed and connected.

After connecting to the power supply, the appliance shows the "Initialisation" display.

The appliance shows the "Initialisation" display when it is first switched on after being connected to the power supply, if the initial start-up has not been completed successfully or the appliance has been restored to the factory settings.

Implement the following settings:

- Setting the language
- Activating Home Connect
- Set the temperature unit
- Set the weight unit
- Setting the time format
- Setting the time

You can retroactively change all of the settings in the basic settings → *Page 33*.

Follow the instructions in the display. The display guides you through the initial settings.

Setting the language and implementing the remaining settings

1. Press .
- ✓ The display shows the preset language.

2. Use the control ring to select the required display language.
 3. Press ✓ to confirm.
 4. Press →.
 5. Implement the remaining settings.
- ✓ The display shows the appliance display that is selected in the basic settings → *Page 33* as the start screen.

Cleaning the door pane

- ▶ Before using for the first time, clean the door pane with glass cleaner and a window cloth or a microfibre cloth.
- Do not use a glass scraper.

Cleaning accessories

- ▶ Before first use, clean the accessories thoroughly using hot soapy water and a soft cloth.

Heating up the appliance

1. Ensure that there is no leftover packaging in the cooking compartment.
2. Remove any accessories from the appliance.
3. To eliminate the new-appliance smell, heat up the empty appliance with the door closed. The ideal setting for heating is 230 °C for one hour without microwave output.
4. Clean the appliance interior.

8 Basic operation

8.1 Switching on the appliance

1. To exit low power mode → *Page 13*, press ⏻ on the appliance's control ring or in the Home Connect app.
 - ✓ The display shows the microwave mode with microwave setting and a symbol for the cooking time.
 - ✓ The appliance switches the interior lighting on.
 - ✓ ⏻ lights up orange.
2. Set the microwave output and cooking time.

Tip: In the basic settings → *Page 33*, you can specify which appliance display appears on the display after the appliance is switched on and whether you want the interior lighting to switch on.

Note: If you do not implement any settings for an extended period, the display shows the appliance display that is selected in the basic settings → *Page 33* as the start screen, and then the low power mode display.

8.2 Opening the appliance door

⚠ WARNING – Risk of burns!

The inside of the appliance door becomes very hot during operation.

- ▶ During or after operation of the appliance, only touch the appliance door at the surface intended for this on the side.
- ▶ Always open the appliance door as far as it will go.

⚠ WARNING – Risk of scalding!

Hot steam may escape when you open the appliance door. Steam may not be visible, depending on the temperature.

- ▶ Open the appliance door carefully.
- ▶ Keep children at a safe distance.

1. Press □.
 - ▶ If the "Door lock" function is activated in the basic settings → *Page 33*, move the slide control to the other end.
- ✓ The appliance door opens automatically.

2. Only touch the appliance door at the designated area  and open it fully.

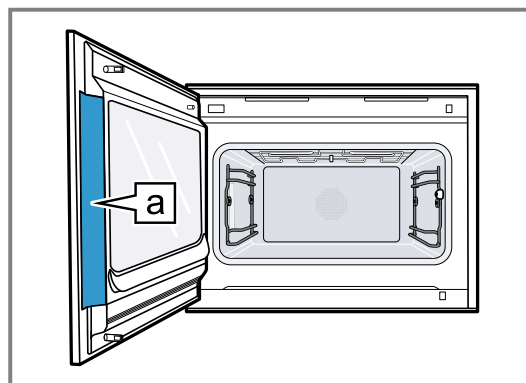

Tip: In the control centre, you can set that the appliance door opens automatically after the current cooking process.

→ *"Opening the appliance door automatically after the cooking process"*, *Page 17*

8.3 Changing the type of heating

1. If required, swipe from right to left to switch from the "Microwave" appliance display to oven mode → *Page 19*.
2. Press the current symbol for the type of heating.
3. Use the control ring to select the required type of heating.
4. Press on the selected type of heating or <, or wait a few seconds.
 - ✓ The display shows the selected type of heating, the default temperature and, for some types of heating, the preset cooking time.
 - ✓ If you have previously used the type of heating, the display shows the last temperature that you used.
5. If required, change the temperature. → *Page 17*
6. If the display shows a message window, follow the instructions in the message window.
7. Press < to switch to the overview of oven mode. If you do not use the appliance for an extended period, the display returns to the previously stored appliance display.
8. Press ▶ to start the operation.

8.4 Changing the temperature

Note: You can change the temperature during operation.

Requirement: The type of heating is selected.

→ "Changing the type of heating", Page 16

1. Press the temperature displayed.
2. Use the control ring to select the desired temperature.
 - ✓ The display shows the temperatures that are available for the selected type of heating.
3. To change the previously stored appliance display, press the required temperature or <.
 - If you do not use the appliance for an extended period, the display returns to the previously stored appliance display.
 - ✓ The display shows the selected temperature.

Note: Once the operation has started, the display shows a progress bar below the selected temperature if the changed temperature is more than 20 °C higher than the previous temperature.

8.5 Displaying the current interior temperature

- ▶ Press and hold the set temperature.
- ✓ The display shows the current interior temperature.

Note: During continuous operation after heating up, slight temperature fluctuations are normal.

8.6 Opening the appliance door automatically after the cooking process

The "automatic door opening" function at the end of the cooking process is only valid for the current cooking process.



⚠ WARNING – Risk of burns!

The appliance and its parts that can be touched become hot during use.

- ▶ Young children under 8 years of age must be kept away from the appliance.
- ▶ Ensure that young children are not in the vicinity of the appliance when the appliance door opens automatically.



Note: Use the "automatic door opening" function at the end of the cooking process only if required to prevent the food from being overcooked or burning.

In order to reduce the amount of moisture deposited on the unit fronts, open the appliance door fully after the cooking time has elapsed if possible.



1. Press .
2. Press .
- ✓ The display shows .
- ✓ The appliance opens the appliance door automatically after the current cooking process with a set cooking time end or set core temperature.

Note: The appliance door also opens when the child-proof lock → Page 25 is activated or the door lock → Page 14 is activated.

8.7 Deactivating the automatic appliance door opening

1. Press .
2. Press .
- ✓ The display shows .
- ✓ The automatic appliance door opening after the cooking process is deactivated.



8.8 Interrupting and continuing an operation

1. To interrupt the operation, press .
2. To continue the operation, press .

8.9 Opening and closing the control centre

1. Press  to open the control centre.
 - ✓ The appliance shows a description above the functions currently active.
2. To activate or deactivate a function as required, press the symbol for the function.
3. Press < to close the control centre.
 - ✓ A pop-up message → Page 13 tells you if a function has been activated.

8.10 Switching the interior lighting on or off

1. Press .
2. Press .

8.11 Switching off the appliance

- ▶ Press  on the control ring.
- ✓ The appliance switches to low power mode.

8.12 Switching on the appliance after automatic switch-off

Requirement: After prolonged operation, the Automatic switch-off → Page 13 switches off the appliance.

- ▶ Press  on the control ring.

8.13 Displaying information

- ▶ Press .
- ✓ The appliance displays information about the selected function.
 - "Additional information", Page 13

8.14 Displaying appliance information

1. Swipe repeatedly from left to right until the display shows "Modes & Service".
 - ✓ The display shows the available functions in a list menu.
2. Use the control ring to select the "Appliance information" function.
3. Press "Appliance information".
 - ✓ The display shows the appliance information, e.g. the E-number and the serial number.
4. Press < to exit the display.

8.15 Using quick guides

1. Select the "Modes & Service" appliance display.
 - "Appliance displays", Page 10

2. Use the control ring to select "Quick guide", then release the control ring.

3. Select the required quick guide and view it.

9 Microwave

You can use the microwave to cook, heat up or defrost food very quickly. The microwave can be used on its own or in combination with a type of heating.

9.1 Microwave-safe cookware and accessories

To heat food evenly and avoid damaging your appliance, it is important to use the right cookware and accessories.

Note: Read the manufacturer's instructions before using any cookware in the microwave. If in doubt, carry out a cookware test.

Microwave-safe

Cookware and accessories	Reason
Cookware made from heat-resistant, microwave-safe material: <ul style="list-style-type: none"> ▪ Glass ▪ Glass ceramic ▪ Porcelain ▪ Temperature-resistant plastic ▪ Fully glazed ceramic without cracks 	These materials allow microwaves to pass through. Microwaves do not damage heat-resistant cookware.
Metal cutlery	Note: You can use metal cutlery, e.g. place a spoon in a glass, to prevent delayed boiling.

ATTENTION

Metal touching the wall of the cooking compartment will cause sparks, which may damage the appliance or the inner door pane.

- ▶ Metal (e.g. a spoon in a glass) must be kept at least 2 cm from the cooking compartment walls and the inside of the door.

Not microwave-safe

Cookware and accessories	Reason
Metal cookware	Metal does not allow microwaves to pass through. The food hardly heats up.
Cookware with gold or silver decoration	Microwaves can damage gold and silver decoration. Tip: You can only use this kind of cookware if the manufacturer guarantees that it is microwave-safe.

9.2 Testing cookware for microwave suitability

Test cookware to see whether it is suitable for microwave use. Testing cookware is the only time the appliance should be operated in microwave mode without any food inside.

⚠ WARNING – Risk of scalding!

The accessible parts of the appliance become hot during operation.

- ▶ Never touch these hot parts.
 - ▶ Keep children at a safe distance.
1. Place the empty cookware in the cooking compartment.
 2. Set the appliance to the maximum microwave power setting for 30 seconds to 1 minute.
 3. Start the operation.
 4. Check the cookware several times:
 - If the cookware is cold or warm to the touch, it is suitable for microwave use.
 - If the cookware becomes hot or sparks are created, stop the cookware test. The cookware is not microwave-safe.

9.3 Microwave power level

This is where you can find an overview of the different microwave power levels and recommendations on when to use them.

Microwave power level	Use
90 W	Defrost delicate foods.
180 W	Defrost foods.
360W	Defrost foods or cook gently.
450 W	Cook foods or warm up gently.
600 W	Cook or warm up foods.
max.	Quickly heat liquids

Notes

- You can set the microwave power levels for a specific cooking time:
 - The "Max." microwave power level for 30 minutes
 - 90 W, 180 W, 360 W, 450 W and 600 W for 90 minutes
- The maximum setting is for heating liquids. To protect the appliance, it reduces the maximum microwave power level after some time. Full power is made available again after a cooling period. During operation, the display shows the current microwave power levels.

9.4 Setting the microwave

1. To set the microwave power level, turn the control ring or press the required microwave power level.

2. To switch to the "Microwave" appliance display, press <
- ✓ The display shows the selected microwave power level.
3. If required, set the cooking time → *Page 22*.
4. If required, move the cooking time end → *Page 23* to a later time.
5. Press ▶.
- ✓ The operation begins. You can see the cooking time counting down.
- ✓ A signal tone sounds once the cooking time has elapsed. Press ✓ or open the appliance door to end the signal early.
- ✓ The operation has finished.

Notes

- If you open the appliance door during cooking, the microwave operation stops. To continue the operation, close the appliance door and press ▶. If you select the "On" setting in the basic settings for the "Automatic resume microwave" function, the appliance automatically continues operation.
- You can change the microwave output or temperature at any time. Press ▶ to start.

9.5 Interrupting and continuing microwave mode





- ▶ Press ■.
- ✓ The display shows the remaining cooking time and the selected microwave power level.





10 Oven

Your appliance has an oven mode.

10.1 Types of heating in oven mode

In oven mode, you can set different types of heating.

Symbols	Function/type of heating	Temperature/setting power	Application
	Hot air	30-230 °C	The heat arises from the back wall of the cooking compartment and is distributed quickly and evenly by the fan. For cooking on one or two levels with an extremely short preheating time. For moist cakes, biscuits, bakes. To reduce the cooking time, the microwave can be switched on.
	Grill + circulated air	30-230 °C	Extremely intensive heat from above, which is distributed quickly and evenly by the fan. Guarantees that a crust is formed with simultaneous all-round heating. For meat, poultry, fish, vegetable skewers. No preheating is required. To reduce the cooking time, the microwave can be switched on.
	Dehydrating	30-80 °C	For drying thin slices of fruit or vegetables or herbs. Moisture is actively extracted from the cooking compartment.
	Low temperature cooking	30-90 °C	Slow and gentle cooking of meat for a particularly tender result. Hot air is combined with a low microwave output in order to reduce the cooking time. Briefly sear meat before cooking.

Symbols	Function/type of heating	Temperature/setting	power	Application
	Dough proving	30-50 °C		Optimal temperature range for proving dough batches and pieces of dough. For yeast and sourdough. The optimal temperature setting for yeast dough is 38 °C.
	Keeping warm		50 W	Optimal microwave output for keeping food warm without it drying out.
	Defrosting		90-360 W	Optimal microwave output range for quickly and gently defrosting frozen food. Use 90 W for delicate foods.
	Warming up beverages		max.	Optimal microwave output for quickly heating liquids such as water and milk.
	Warming up meals		360-600 W	Optimal microwave output range for heating up cooked meals, such as plated meals, bakes and soups.

10.2 Setting the type of heating and the temperature

- If required, swipe from right to left to switch from the "Microwave" appliance display to oven mode → *Page 19*.
- Press the current symbol for the type of heating.
- Use the control ring to select the required type of heating.
- Press on the selected type of heating or <, or wait a few seconds.
 - ✓ The display shows the selected type of heating, the default temperature and, for some types of heating, the preset cooking time.
 - ✓ If you have previously used the type of heating, the display shows the last temperature that you used.
- Set the required temperature if necessary.
 - ▶ Press the temperature displayed.
 - ▶ Use the control ring to select the desired temperature.
 - ▶ Press the required temperature.

If you do not use the appliance for an extended period, the display returns to the previously stored appliance display.
- If the display shows a message window, follow the instructions in the message window.
- If required, set the cooking time → *Page 22* or the core temperature → *Page 28*.
- If required, move the cooking time end → *Page 23* to a later time.
- To switch to the previous appliance display, press <. If you do not use the appliance for an extended period, the appliance returns to the previously stored appliance display.
- Press ▶ to start the operation.

Interrupting and continuing an operation

- To interrupt the operation, press ■.
- To continue the operation, press ▶.

10.3 Add grill



You can brown or gratinate your food using the grill. The "Add grill" function is available for the "Hot air" type of heating if the temperature in the cooking compartment is higher than 150 °C. The "Add grill" function is not available until a temperature of 150 °C is reached. After approx. 4 minutes, the appliance switches the grill off. If required, you can switch the grill on again.

Turning on the grill

ATTENTION

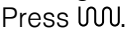

Temperatures above 250 °C damage the core temperature probe.

- ▶ If you use the core temperature probe, never place the food on the top shelf level.

- Use the control ring to select the "Hot air" type of heating for the grill.
- Press .
- ✓  lights up.
- ✓ The appliance switches the grill off for approx. 3 minutes.

Deactivating the grill

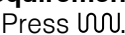
Requirement:  lights up orange.

- ▶ Press .
- ✓  lights up white.
- ✓ The grill is deactivated.

11 Combined operation

To reduce the cooking time and brown your meals, you can use the "Hot air" or "Grill + circulated air" types of heating in combination with a microwave output.

Note: You can switch on microwave output settings up to 450 W.

The appliance reduces the maximum microwave output level after a longer period of operation. The maximum power output is made available again after a certain cooling period.

11.1 Setting combined operation

1. Use the control ring to select the "Hot air" or "Grill + circulated air" type of heating.
2. Press the type of heating or <.

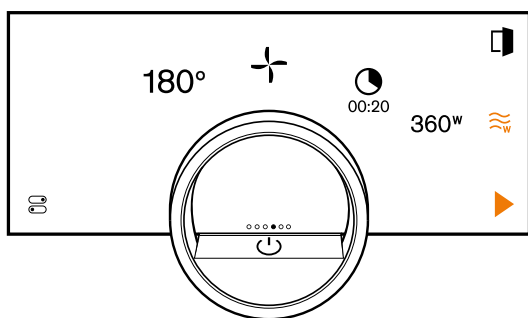

3. Add a microwave power level using \approx .
You can also add the microwave operation while a heating process is active.
 - ✓ The display shows the preset microwave output level for the selected type of oven heating and a preset cooking time.
4. Press \odot .
 - ✓ The display shows h : min for hours and minutes.
5. Press on the desired value for the cooking time → *Page 22* and change the value using the control ring.
 - ▶ Turn the control ring slowly to change the value in smaller increments.
 - ▶ Turn the control ring quickly to change the value in greater increments.

The maximum possible cooking time depends on the type of heating.
6. Press < or press on the selected cooking time to switch to the previously stored appliance display. If you do not use the appliance for an extended period, the appliance saves the settings and the display returns to the previously stored appliance display.
7. Press on the required microwave power level and use the control ring to select the required microwave output.
If you do not use the appliance for an extended period, the display returns to the previously stored appliance display.
8. Set the cooking time → *Page 22* or the core temperature → *Page 28*.

9. Press ▶.
 - ✓ The operation begins. You can see the cooking time counting down.
 - ✓ A signal tone sounds once the cooking time has elapsed.
 - ✓ After a certain period of time without any further operation, the appliance ends the signal tone. You can set the duration of the signal tone in the basic settings → *Page 33*.
 - ✓ The operation has finished.
 - ✓ After around 1 minute, the appliance displays the previously set temperature, the type of heating, cooking time, microwave output and the time elapsed since the end of operation.
10. Press on the display to end the additional cooking time timer.

Note: If there is no further operation following the signal tone, the display shows the "Standing time timer" function with the + symbol. The display shows how much time has elapsed since the cooking time ended. After approx. 20 minutes without any further operation, the appliance switches to low power mode.

Changing settings

1. To change the type of heating, press on the type of heating and use the control ring to select a different type of heating.
If you select a type of heating for which combi-operation is not available, the appliance switches to oven mode.
2. To change the temperature, press on the temperature and use the control ring to select a different temperature.
3. To change the microwave output, press on the microwave output and use the control ring to select a different microwave output.
4. Change the cooking time → *Page 22*.
5. Press ▶ to start.

Interrupting and continuing an operation

1. To interrupt the operation, press ■.
 - ✓ The display shows the temperature, the type of heating and the cooking time. In combined operation, the display also shows the microwave power setting.
2. To continue the operation, press ▶.

Note: The fan may also continue to run when the door is open. This is normal.

11.2 Removing the microwave operation

Requirement: The "Hot air" or "Grill + circulated air" type of heating is selected.

- ▶ Press \approx .
You can also delete the microwave operation while a heating process is active.
- ✓ The display shows the type of heating and the preset cooking time for the type of heating.
- ✓ The display shows \approx .

11.3 Switching from combined operation to microwave mode



1. To interrupt the operation, press ■.
2. Swipe repeatedly from left to right until the display shows the possible settings for microwave operation.

12 Timer functions

Your appliance has different timer functions, with which you can control its operation.

12.1 Overview of the timer functions

Use  to select the different timer functions.

Timer function	Use
	Cooking time
	Cooking time end

A cooking time or cooking time end can only be set in combination with a type of heating. The "Cooking time" and "Core temperature probe" functions are not available at the same time.

12.2 Calling up the timer menu

- ▶ Press .
- ✓ Depending on the set type of heating, the display shows min and s for minutes and seconds or h and min for hours and minutes.
- ✓ The display shows the display for the minutes enlarged in the 12 o'clock position.

12.3 Exiting the timer menu

- ▶ Press < or press on the selected cooking time to switch to the previously stored appliance display.
- ✓ The timer menu is closed.

12.4 Cooking time

When you set the cooking time for your food, the appliance automatically switches off after this time. The maximum possible cooking time depends on the set type of heating.

Depending on the type of heating, you can set a cooking time of 1 minute to 30 minutes, 90 minutes or 24 hours.

For the "Dehydrating" type of heating, the maximum cooking time is 72 hours.

You can change the type of heating and temperature while the cooking time counts down.

Setting the cooking time

Requirement: No core temperature is set. You cannot use the "Cooking time" and "Core temperature probe" functions at the same time.

1. Place the food in the cooking compartment.
2. Press .
- ✓ Depending on the type of heating, the display shows min : s for minutes and seconds or h : min for hours and minutes.
3. Press the required value and use the control ring to change the value.
 - ▶ Turn the control ring slowly to change the value in smaller increments.

- ▶ Turn the control ring quickly to change the value in greater increments.

The maximum possible cooking time depends on the type of heating.
- ✓ The appliance automatically calculates the time for the cooking time end.
- 4. Press < or press on the selected cooking time to switch to the previously stored appliance display. If you do not use the appliance for an extended period, the appliance saves the settings and the display returns to the previously stored appliance display.
- ✓ If the appliance is in operation, the appliance shows the temperature or microwave output, the operating mode and the remaining cooking time.
- ✓ For a cooking time of more than 59 minutes, the display uses the format h : min for hours and minutes.
- ✓ For a cooking time less than 60 minutes and depending on the heating mode set, the display uses the format min : s for minutes and seconds.
- ✓ 3 minutes before the end of the cooking time, the display zooms in on the remaining cooking time.
- ✓ After the cooking time has elapsed, the display shows 00:00 and a signal tone sounds.
- 5. Turn the control ring or open the appliance door. The appliance door opens automatically if you have activated this function.

→ "Opening the appliance door automatically after the cooking process", Page 17
- ✓ The signal tone stops.

Note: If there is no further operation following the signal tone, the display shows the "Standing time timer" function with the + symbol. The display shows how much time has elapsed since the cooking time ended. After approx. 20 minutes without any further operation, the appliance switches to low power mode.

Changing the cooking time

For types of heating that require a cooking time, you can change the cooking time. For types of heating that do not require a cooking time, you can either change or delete the cooking time.

Requirement: You have set a type of heating.

1. Press .
- ✓ Depending on the type of heating, the display shows min : s for minutes and seconds or h : min for hours and minutes.
2. Press the required value and use C to delete the value or use the control ring to change the value.
 - ▶ Turn the control ring slowly to change the value in smaller increments.

- ▶ Turn the control ring quickly to change the value in greater increments.

For types of heating that require a cooking time, you cannot delete the cooking time but you can reset it to the preset cooking time using ↵.

The maximum possible cooking time depends on the type of heating.

- ✓ The appliance automatically calculates the time for the cooking time end.
3. Press < or press on the selected cooking time to switch to the previously stored appliance display. If you do not use the appliance for an extended period, the display returns to the previously stored appliance display.
 - ✓ The display shows the temperature or microwave output, the operating mode, the remaining cooking time, and the cooking time end.

Deleting or resetting the cooking time

Note: For types of heating that require a cooking time, do not delete the cooking time.

For types of heating that do not require a cooking time, in the "Manual" (oven mode) appliance display, you can double-click on the cooking time in order to delete the cooking time without switching to the timer settings.

1. Press ○.
- ✓ Depending on the type of heating, the display shows min : s for minutes and seconds or h : min for hours and minutes.
2. Press the required value and use C to delete the value.
- ✓ The display shows --:--.
3. Press < or press on the selected cooking time to switch to the previously stored appliance display. If you do not use the appliance for an extended period, the display returns to the previously stored appliance display.
- ✓ The display does not show a cooking time.

12.5 Cooking time end

As soon as you set a cooking time, the display shows the cooking time end. You can delay the cooking time end by a maximum of 12 hours.

For example, if you set a cooking time of 90 minutes at 10 a.m., you can delay the end of the cooking time so that the cooking process ends at 11.30 p.m. at the latest.

For the "Dehydrating" type of heating, the maximum cooking time is 72 hours.

Bear in mind that food which spoils easily should not be left in the appliance for too long.

Delaying the cooking time end

Requirement: No core temperature is set. You cannot use the "Cooking time" and "Core temperature probe" functions at the same time.

1. Place the food in the cooking compartment.
2. Press ○.
- ✓ Depending on the type of heating, the display shows min : s for minutes and seconds or h : min for hours and minutes.
3. Set the cooking time. → *Page 22*
- ✓ The appliance automatically calculates the time for the cooking time end.

4. Press < or press on the selected cooking time to switch to the previously stored appliance display. If you do not use the appliance for an extended period, the display returns to the previously stored appliance display.
5. Press on the cooking time end.
6. Use the control ring to set the required cooking time end.
7. Press ▶.
- ✓ The appliance switches to standby.
- ✓ The display shows the temperature or microwave output, the operating mode, and the cooking time end.
- ✓ If the cooking time end is one or more days in the future, the display shows "+1d".
- ✓ The appliance starts at the calculated time and automatically switches off once the cooking time has elapsed.
- ✓ After the cooking time has elapsed, the display shows 00:00 and a signal tone sounds.
8. Turn the control ring or open the appliance door. The appliance door opens automatically if you have activated this function.
 - *"Opening the appliance door automatically after the cooking process", Page 17*
- ✓ The signal tone stops.

Note: If there is no further operation following the signal tone, the display shows the "Standing time timer" function with the + symbol. The display shows how much time has elapsed since the cooking time ended. After approx. 20 minutes without any further operation, the appliance switches to low power mode.

Resetting the delay of the cooking time end

Note: In the "Microwave" appliance display or in the "Manual" (oven mode) appliance display, double-click on the cooking time end in order to reset the delay of the cooking time end without switching to the timer settings.

Requirement: You have used the control ring to manually set the cooking time end.

1. Press →.
2. To reset the delay of the cooking time, press ↵.
- ✓ The appliance calculates the cooking time end based on the cooking time.
- ✓ The display shows the cooking time end.
3. Press < or press on the cooking time end to switch to the previously stored appliance display. If you do not use the appliance for an extended period, the display returns to the previously stored appliance display.

12.6 Count-up cooking timer

If no cooking time is set, the display shows the time that has elapsed since the start of the process. In the basic settings, you can switch the "Count-up cooking timer" function on or off.

Resetting "Count-up cooking timer"

1. Press and hold ○.
2. Press ↵.
- ✓ The "Count-up cooking timer" function is reset.

13 Long-term timer

You can use this function to keep food warm and cook food for up to 74 hours without having to switch the appliance on or off. You can select the "Hot air" type of heating, temperature and the required cooking time. Bear in mind that food which spoils easily should not be left in the appliance for too long.

You can use the "Long-term timer" function to program 9 different heating cycles with a total cooking time of 74 hours. Set a start time and an end time. The display shows which settings have been selected.

You can define whether the interior lighting is switched on or switched off during the selected cooking time. At the end of the selected cooking time, the appliance automatically deactivates the function. If required, you can deactivate the "Long-term timer" function at any time using the on/off button .

If the "Long-term timer" function is active, the display screen does not change when you approach the appliance.

If the "Long-term timer" function is active, you cannot operate the appliance via the display and the control ring and you can only open the door manually using the manual door opening aid. Install the manual door opening aid before you start the "Long-term timer" function. If the "Long-term timer" function is active, the "Automatic door opening at the end of the cooking process" function is not available.

If the "Long-term timer" function is active and you open the appliance door, the appliance ends the heating operation after a randomly selected time of approx. 20 to 30 seconds. If you close the appliance door again, the appliance starts the heating operation after a randomly selected time of approx. 20 to 30 seconds. To avoid interrupting the heating operation, only open the appliance door between two heating operations.

13.1 Opening the "Long-term timer" function



Requirement: The "Long-term timer" function is set to "On" in the basic settings → *Page 33*.

1. Swipe repeatedly from left to right until the display shows "Modes & Service".
 2. Use the control ring to select the "Long-term timer" function.
 3. Set the switch to the right of the "Long-term timer" list entry to "On".
- ✓ The display shows the start time and the end time.

13.2 Selecting a time period for the "Long-term timer" function

Requirement: The "Long-term timer" function is set to "On" in the basic settings → *Page 33*.

1. Press the start time.
 2. Use the control ring to change the start time.
 3. Press .
- ✓ The appliance automatically calculates the time for the end time.
- ✓ The display shows the start time and the end time.
4. Press the end time.
 5. Use the control ring to change the end time.
- ✓ The display shows the start time and the end time.

6. Press  to confirm.
- ✓ The display shows .

Note: If you set a delayed start time for the "Long-term timer" function, you can only start cooking processes with a programmed end time.



The following functions are not available:

- Cleaning programme
- Some cooking programmes
- Cooking processes with a set core temperature
- Cooking processes without a cooking time end









13.3 Selecting the settings for the interior lighting while the "Long-term timer" function is active

Requirement: A start time and an end time are selected.

→ *"Selecting a time period for the Long-term timer function", Page 24*



1. Press .
 2. To switch the interior lighting on at the lowest lighting level for the entire time while the "Long-term timer" function is active, set the switch for the interior lighting to "On".
 3. To switch the interior lighting off for the entire time while the "Long-term timer" function is active, set the switch for the interior lighting to "Off".
- ✓ The display shows the start time and the end time.
4. To program the first heating cycle, press .
 - *"Setting heating cycles", Page 24*

13.4 Setting heating cycles



1. Press .
- ✓ The display shows the settings that have been selected for the "Long-term timer" function.
2. Press "Summary".
 3. Press .
 4. Press .
 5. Press the temperature to set it.
 - ▶ Use the control ring to select the required temperature and press .
 6. Press the start time to change it.
 - ▶ Use the control ring to change the start time and press .
 7. Press the end time to change it.
 - ▶ Use the control ring to change the end time and press .
- ✓ The display shows the settings for the first heating cycle.
8. Press  to confirm.
 9. To program a further heating cycle, if needed, press .
 - ▶ Program the settings for the further heating cycle. You can program up to 9 heating cycles.
- ✓ The display shows the settings for the programmed heating cycles.
- ✓ The display shows the start time and the end time for the "Long-term timer" function.
10. Touch the control ring.
- ✓ The display shows the settings for the programmed heating cycles.

11. Navigate through the list of programmed heating cycles in the menu with the control ring.



13.5 Changing the time period for the "Long-term timer" function

1. Press .
- ✓ The display shows the settings that have been selected for the "Long-term timer" function.
2. Press "Summary".
3. Press .
4. Press .
- ✓ The display shows the start time and the end time.
5. Press the start time and use the control ring to change the start time.

13.6 Changing settings for the interior lighting



1. Press .
- ✓ The display shows the settings that have been selected for the "Long-term timer" function.
2. Press "Summary".
3. Press .
4. To switch the interior lighting on at the lowest lighting level for the entire time while the "Long-term timer" function is active, set the switch for the interior lighting to "On".
5. To switch the interior lighting off for the entire time while the "Long-term timer" function is active, set the switch for the interior lighting to "Off".

13.7 Changing the heating cycle

1. Press .
- ✓ The display shows the settings that have been selected for the "Long-term timer" function.
2. Press "Summary".
3. Press .

4. Navigate through the list of programmed heating cycles in the menu with the control ring and press the required heating cycle.
5. To change the settings for the heating cycle, press the corresponding settings.
6. To save the changed setting, press .

13.8 Deleting a heating cycle

1. Press .
- ✓ The display shows the settings that have been selected for the "Long-term timer" function.
2. Press "Summary".
3. Press .
4. Navigate through the list of programmed heating cycles in the menu with the control ring and select the required heating cycle.
5. Press .

13.9 Starting the "Long-term timer" function

Tip: Install the manual door opening aid before you start the "Long-term timer" function.

- ▶ Press  to start.
- ✓ The "Long-term timer" function starts.
- ✓ At the end of the "Long-term timer" function, the appliance switches off.

13.10 Switching off the "Long-term timer" function

1. Swipe repeatedly from left to right until the display shows "Modes & Service".
2. Use the control ring to select the "Long-term timer" function.
3. Set the switch to the right of the "Long-term timer" list entry to "Off".

Note: To switch off the "Long-term timer" function, you can also press  on the control ring.

14 Childproof lock

Activate the "Childproof lock" function so that children cannot accidentally switch the appliance on or change the settings.



If the childproof lock is activated, operation via the display and the control ring is not possible.

If the childproof lock is activated and the power fails, the childproof lock can be deactivated when the power comes back on.

You can activate the childproof lock even during operation.

14.1 Activating the childproof lock

Requirement: In the basic settings → *Page 33*, the option "On" is set for the "Display child lock" function.

1. Press .
2. Press .
- ✓ The display shows .
- ✓ The "Childproof lock" function is activated.

14.2 Deactivating the childproof lock

1. Press and hold  for approx. 2 seconds.
- ✓ The "Childproof lock" function is deactivated.
2. Set the appliance as normal.

15 Programmes

The "Programmes" appliance display includes the automatic programmes and setting recommendations.

15.1 Automatic programmes

You can use the "Automatic programmes" function to cook a wide variety of food. The appliance selects the optimal setting for you.

In automatic programmes, the appliance defines the optimal settings after you enter the weight and required cooking result, for example. The automatic programmes are labelled with a checkmark in the overview list.

You can find information about the accessories or shelf levels in the tip for the respective programme.

Note: In the basic settings → *Page 33*, you can filter automatic programmes, e.g. with the following filters "Vegetarian" or "No meat & poultry".

Information about the settings for the automatic programmes

Observe the instructions for the settings of the automatic programmes.

- The cooking result depends on the quality of the food and the size and type of cookware. For an optimal cooking result, only use food that is in good condition and meat that is chilled to refrigerator temperature. For frozen food, only use food straight out of the freezer.
- The food is divided into categories. One or more dishes are listed for each category. The display shows the last selected meal.
- For some dishes, the appliance asks you to enter, for example, the weight, the desired level of browning, the thickness of the food or the cooking level of the food.
- For some food, preheat the empty cooking compartment for an optimal cooking result. Only place the food in the cooking compartment once the preheating is complete and a message is shown on the display.
- The appliance displays the selected settings next time as a suggestion.
- For some programmes, you need the core temperature probe. Use the core temperature probe → *Page 28* for these programmes.
- To achieve good results, the cooking compartment must not be too hot for the type of food you have selected. If the cooking compartment is too hot, the display shows a corresponding notification. Allow the appliance to cool and restart it.

Selecting an automatic programme

1. Swipe repeatedly from right to left until the display shows "Programmes".
 - ✓ The display shows the first programme in the "Vegetables" category or the last set automatic programme.
 - ✓ The display shows the preselected values for the programme or the last set values.
 - ✓ The display shows a tip and symbols for the Favourites → *Page 28* category and for the programme start.
2. Use the control ring to select the required meal and press on the required meal.
 - ✓ The display shows the name of the selected dish and the corresponding values.

Changing category

1. Press the symbol for the category.
 - ✓ The display shows the available categories in the ring menu.
2. Select the required category with the control ring.
3. Press < or press the category in order to confirm the selection.
 - ✓ The display shows the first dish in the selected category and the corresponding values.

Changing the programme

1. Press on the name of a dish or navigate through the list of dishes in the menu with the control ring.
2. Press the required food.
 - ✓ The display shows the name of the selected dish and the corresponding settings.
3. Press the setting.
4. Use the control ring to change the setting and press on the required setting.
 - Not all settings can be changed.
 - You cannot change the type of heating.
5. Press <.
 - ✓ The display shows the name of the selected dish and the corresponding settings.
6. Press □.
- ✓ The display shows information about the accessories and preparation.
7. Follow the information on the display.

Starting the automatic programme

- ▶ Press ▶.
- ✓ Once the cooking time has elapsed, a signal tone sounds.
- ✓ The appliance stops heating.

Note: If you open the appliance door during an automatic programme, this affects the cooking result. Do not open the appliance door, or only open it briefly. The appliance interrupts the automatic programme and continues to run when you close the appliance door.

Extending the cooking time

If you are still not satisfied with the cooking result, you can increase the cooking time again.

1. Press 00.00.
2. Select the required cooking time.
3. Press ✓ to confirm.

Cancelling the automatic programme

Note: Once you have started the automatic programme, you can no longer change the settings.

- ▶ Press ■.
- ✓ The appliance ends the automatic programme.

Saving a programme as a favourite

You can save a programme as a favourite at the start or end of an automatic programme.

1. Press □.
- ✓ The display shows the "Favourites" appliance display.
2. Press ∅.
3. Use the keyboard to enter a name.
4. Press ✓.
 - You can only change the settings for a saved favourite via the Home Connect app.

15.2 Recommended settings

With setting recommendations, the appliance specifies the optimal type of heating.

The setting recommendations are not labelled with a checkmark in the overview list.

If a weight is specified in the tip, the recommended temperature and the cooking time relate to this weight specification. You can adapt the temperature and cooking time within the available ranges.

You can find information about the accessories or shelf levels in the tip for the respective programme.

Information on the setting recommendations

Observe the information on the setting recommendations.

- The cooking result depends on the quality of the food and the size and type of cookware. For an optimal cooking result, only use food that is in good condition and meat that is chilled to refrigerator temperature. For frozen food, only use food straight out of the freezer.
- The food is divided into categories. One or more dishes are listed for each category. The display shows the last selected meal.
- With the setting recommendations, the appliance specifies the type of heating.
- You can change the temperature and the cooking time in the specified areas.
- For some food, preheat the empty cooking compartment for an optimal cooking result. Only place the food in the cooking compartment once the preheating is complete and a message is shown on the display.
- The appliance displays the selected settings next time as a suggestion.
- To achieve good results, the cooking compartment must not be too hot for the type of food you have selected. If the cooking compartment is too hot, the display shows a corresponding notification. Allow the appliance to cool and restart it.

Selecting a setting recommendation

1. Swipe repeatedly from right to left until the display shows "Programmes".
 - ✓ The display shows the first programme in the "Vegetables" category or the last set automatic programme.
 - ✓ The display shows the preselected values for the programme or the last set values.
 - ✓ The display shows a tip and symbols for the Favourites → *Page 28* category and for the programme start.
2. Use the control ring to select the required meal and press on the required meal.
 - ✓ The display shows the name of the selected dish and the corresponding values.

Changing category

1. Press the symbol for the category.
 - ✓ The display shows the available categories in the ring menu.

2. Select the required category with the control ring.
3. Press < or press the category in order to confirm the selection.
 - ✓ The display shows the first dish in the selected category and the corresponding values.

Changing the programme

1. Press on the name of a dish or navigate through the list of dishes in the menu with the control ring.
2. Press the required food.
 - ✓ The display shows the name of the selected dish and the corresponding settings.
3. Press the setting.
4. Use the control ring to change the setting and press on the required setting.
 - Not all settings can be changed. You cannot change the type of heating.
5. Press <.
 - ✓ The display shows the name of the selected dish and the corresponding settings.
6. Press □.
- ✓ The display shows information about the accessories and preparation.
7. Follow the information on the display.

Starting a setting recommendation

- ▶ Press ▶.
- ✓ Once the cooking time has elapsed, a signal tone sounds.
- ✓ The appliance stops heating.

Note: If you open the appliance door when a setting recommendation is running, this affects the cooking result. Do not open the appliance door, or only open it briefly. The appliance interrupts the setting recommendation and continues to run when you close the appliance door.

Extending the cooking time

If you are still not satisfied with the cooking result, you can increase the cooking time again.

1. Press 00.00.
2. Select the required cooking time.
3. Press ✓ to confirm.

Setting recommendations

Note: Once you have started the setting recommendation, you can change the settings.

1. Press on the setting recommendation.
2. Change the desired settings.

Saving a programme as a favourite

You can save a programme as a favourite at the start or end of a setting recommendation.

Requirements

- The temperature and type of heating are set.
 - The cooking time or core temperature is set.
1. Press □.
 - ✓ The display shows the "Favourites" appliance display.
 2. Press ∅.
 3. Use the keyboard to enter a name.
 4. Press ✓.
 - You can only change the settings for a saved "Favourites" via the Home Connect app.

16 Favourites

In the "Favourites" appliance display, you can save preferred automatic programmes, setting recommendations or combinations of type of heating, temperature, core temperature or cooking time. The appliance adopts the selected settings, such as microwave power, temperature, cooking time, weight or level of browning for the favourites.

You can individually select the names for the favourites. You can use the Home Connect app to change the saved settings for the favourite or the order of the favourites.

After starting the favourites, you can change the settings.



→ "Changing the favourite", Page 28

16.1 Creating the first favourites

Notes

- You can save a food as a favourite at the beginning or end of an automatic programme or a setting recommendation.
- You can save a favourite in the "Manual operation" appliance display. As soon as you have selected the settings for the temperature, the type of heating, the cooking time or the microwave power setting, the display shows .

Requirement: The settings for the favourites are selected or a heating process ends.

1. Press .
- ✓ The display shows the "Favourites" appliance display.
2. Press .
3. Use the keyboard to enter a name.
4. Press .



16.2 Selecting a favourite

1. Swipe repeatedly from right to left until the display shows "Favourites".
→ "Appliance displays", Page 10
2. Use the control ring to select the desired favourites.
3. Press the favourites.

16.3 Renaming a favourite

Requirement: The favourite has been selected.

→ "Selecting a favourite", Page 28

1. Press .
2. Enter the name for the favourite.
3. Press  to confirm.

16.4 Starting the favourite

Requirement: The favourite has been selected.



→ "Selecting a favourite", Page 28

- ▶ Press  to start.

16.5 Changing the favourite

The availability of settings depends on the favourite selected.

Requirements

- The favourite has been selected.
→ "Selecting a favourite", Page 28
 - The favourite is stopped.
1. Change the selected settings, e.g. the temperature, the type of heating or the cooking time.
The "Add grill" function is unavailable.
The "Automatic door opening at process end" function is available.
If you have saved an automatic programme as a favourite, you can only change certain settings, e.g. the weight, the required degree of browning, the thickness of the food or the cooking level of the food.
If you have saved a setting recommendation as a favourite, you can change the settings on the appliance as soon as the favourite is started. You can only save the changed settings via the Home Connect app. As soon as the favourite is stopped or has finished, the Home Connect app asks if you would like to save the settings in the favourite.
 2. Press .
 3. Press  to start.
 - ✓ The operation starts with the changed settings.



Note: The appliance does not save the changed settings in the selected favourite. If you select the favourite again, the settings match the settings when the favourite was created.

You can use the Home Connect app to change the settings for the favourites.

16.6 Deleting a favourite

Requirement: The favourite has been selected.

→ "Selecting a favourite", Page 28

1. Press .
2. Press  to confirm.

17 Core temperature probe

The core temperature probe makes it possible to cook with exact precision. The core temperature probe measures the temperature at 3 measuring points inside the food. When the required core temperature is reached, the appliance automatically switches off, ensuring that all food is cooked perfectly.

WARNING – Risk of burns!

The cooking compartment and the core temperature probe become very hot.

- ▶ Use oven gloves when inserting and removing the core temperature probe.

⚠ WARNING – Risk of electric shock!

An incorrect core temperature probe may damage the insulation.

- ▶ Only use the core temperature probe that is suitable for this appliance.

ATTENTION

Aggressive cleaning agents may damage the core temperature probe.

- ▶ Do not clean the core temperature probe in the dishwasher.

⚠ WARNING – Risk of injury!

The core temperature probe is sharp.

- ▶ Handle the core temperature probe with care.

Only use the core temperature probe that is suitable for this appliance. The core temperature probe → *Page 15* is available as a spare part from customer service or the online shop. You can also use the core temperature probe for the Gaggenau oven or the combi-steam oven in the same series.

If you use the core temperature probe, never place the food on the top shelf level.

After use, always remove the core temperature probe from the cooking compartment. Never store the core temperature probe in the cooking compartment.

After each use, clean the core temperature probe with a damp cloth.

The measurable range is 15 °C to 100 °C. Outside of the measurable range, the display shows "<15 °C" or ">100 °C" for the current core temperature.

If you leave food in the cooking compartment for some time after cooking, the core temperature will continue to rise somewhat due to the residual heat in the cooking compartment.

17.1 Inserting the core temperature probe into the food

1. Insert the core temperature probe fully into the food.
2. Do not insert the core temperature probe into the fat.
3. Ensure that the core temperature probe is not touching any cookware or any bones.
4. Place the food in the cooking compartment.

Inserting the core temperature probe into meat

1. Insert the core temperature probe at the thickest point on the side as far as it will go into the meat.

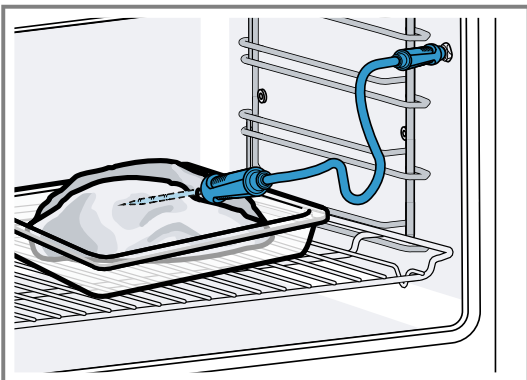

2. If there is more than one piece of meat, insert the core temperature probe into the middle of the thickest piece.

Inserting the core temperature probe into poultry

1. Insert the core temperature probe as far as it will go into the thickest point in the breast.

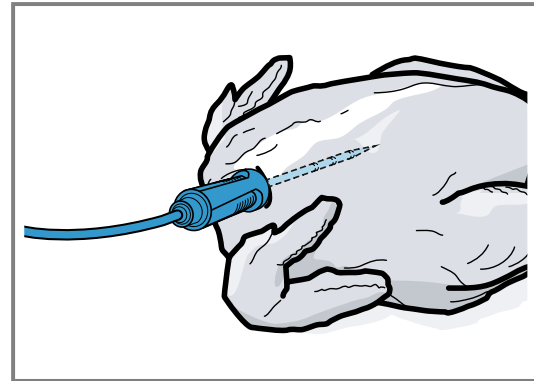

2. Depending on its composition, insert the core temperature probe into the poultry crossways or lengthways.

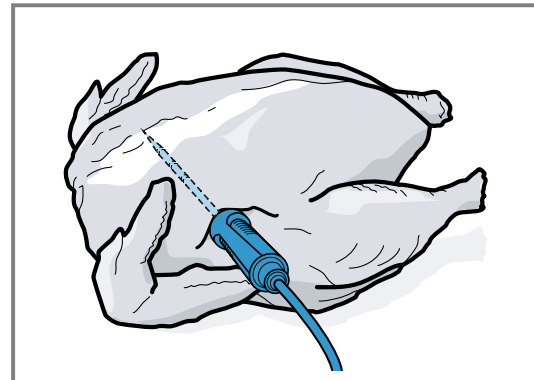

3. With poultry, ensure that the tip of the core temperature probe does not protrude into the cavity in the middle of the bird.

Inserting the core temperature probe into fish

1. Insert the core temperature probe behind the head as far as it will go towards the spine.

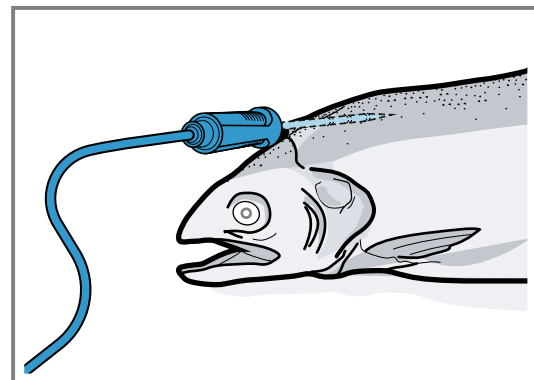

2. Place the whole fish onto the wire rack and prop it up in the swimming position using half a potato.

17.2 Turning the food

1. Do not pull out the core temperature probe when turning the food.
2. Turn the food.
3. Once you have turned the food, check that the core temperature probe is correctly positioned in the food.

17.3 Setting the core temperature probe

ATTENTION



The heat of the grill heating element may damage the core temperature probe.

- ▶ Ensure that the distance between the grill heating element and the core temperature probe and the cable of the core temperature probe is a few centimetres. In doing so, ensure that the meat can expand during the cooking process.

You may damage the cable of the core temperature probe with the appliance door.

- ▶ Do not trap the cable of the core temperature probe in the appliance door.

Requirement: A cooking time end is not set. The cooking time end and core temperature probe functions are not available at the same time.

1. Slide the food into the cooking compartment with the core temperature probe inserted.
2. Insert the core temperature probe into the socket in the cooking compartment.
3. Close the appliance door.
- ✓ The display shows the current cooking compartment temperature and the symbol for the core temperature probe .
4. Select the required type of heating and cooking compartment temperature with the control ring.
5. Press .
6. Use the control ring to select the required core temperature → *Page 30*.
 - ▶ Ensure that the set core temperature is higher than the current core temperature.

You can change the set core temperature at any time.

7. The set core temperature can be cleared and reset as needed with C or the control ring.
8. Press < or press the set core temperature.
9. Press ▶.
 - ✓ The appliance heats up using the set type of heating.
 - ✓ Once you have set the core temperature, the display shows the type of heating and the current core temperature.
 - ✓ Once you have set the core temperature, the display shows the type of heating and intermittently switches to the estimated time → *Page 31* until the core temperature is reached and the current and set core temperature.
 - ✓ If the current core temperature is 5 °C below the set core temperature, the display shows the current and set core temperature as enlarged.
 - ✓ Once the core temperature for the food has been reached, the display shows the required core temperature alongside the set core temperature and a signal sounds.
 - ✓ The appliance ends the cooking process automatically.

Note: If you do not continue to operate the appliance after the signal tone, the display shows how much time has elapsed since the food reached the core temperature.

Once you start operating the appliance again, the appliance clears the time display. After approx. 20 minutes without any further operation, the appliance switches to low power mode.

17.4 Deleting the set core temperature

- ▶ In the "Microwave" or "Manual" (oven mode) appliance display, double-click on the temperature. → *"Appliance displays", Page 10*
- ✓ The display shows the current core temperature.

17.5 Changing the set core temperature

1. Press .
2. Change the set core temperature with the control ring.

Once the display shows the set core temperature enlarged in the 12 o'clock position, you can change the set core temperature directly using the control ring.

17.6 Core temperature guideline values

The following overview provides you with guideline values for the core temperature. The guideline values depend on the quality and composition of the food. Only use fresh food that has not been frozen. For hygiene reasons, ensure that critical foods such as fish and game reach a core temperature of at least 62-70 °C and poultry and minced meat 80-90 °C.

Food	Core temperature guideline value in °C
Beef	
Sirloin, fillet of beef, entrecôte, roast beef, rare	47-55
Sirloin, fillet of beef, entrecôte, roast beef, medium rare	56-63
Sirloin, fillet of beef, entrecôte, roast beef, medium	64-70
Sirloin, fillet of beef, entrecôte, roast beef, well done	71-75
Pork	
Joint of pork	75-80
Loin of pork, medium rare	65-70
Loin of pork, medium	71-75
Loin of pork, well done	76-80
Meatloaf	85
Fillet of pork, medium rare	65-70
Pork fillet, medium	71-75
Veal	
Joint of veal, well done	75-80
Breast of veal, stuffed, well done	75-80
Saddle of veal, medium	64-70
Saddle of veal, well done	71-75
Fillet of veal, rare	50-55
Fillet of veal, medium rare	56-63
Fillet of veal, medium	64-70
Fillet of veal, well done	71-75
Game	

Food	Core temperature guideline value in °C
Saddle of venison	60-70
Leg of roe venison	70-75
Venison loin steaks	65-70
Saddle of hare, saddle of rabbit	65-70
Poultry	
Chicken	90
Guinea fowl	80-85
Goose, turkey, duck	85-90
Duck breast, medium rare	55-60
Duck breast, medium	61-70
Duck breast, well done	71-80
Ostrich steak	60-65
Lamb	
Leg of lamb, medium	65-69
Leg of lamb, well done	70-80
Saddle of lamb, medium rare	55-60
Saddle of lamb, medium	61-64
Saddle of lamb, well done	65-75
Mutton	
Leg of mutton, medium rare	70-75
Leg of mutton, medium	76-80
Leg of mutton, well done	81-85
Saddle of mutton, medium	70-75

Food	Core temperature guideline value in °C
Saddle of mutton, well done	76-80
Fish	
Fillet, whole, medium	58-64
Fillet, whole, well done	65-68
Terrine	62-65
Other	
Bread	96
Pâté	72-75
Terrine	70-75
Foie gras	45-60
Reheating food	75

17.7 Estimated cooking time

After preheating, if the appliance has a temperature setting above 120 °C and the core temperature probe is inserted, the display shows an estimated cooking time a few minutes into the cooking time. The appliance continuously updates the estimated cooking time.

The estimated cooking time is only available if you connect your appliance to the Home Connect app.

The longer the cooking process lasts, the more precise the estimated cooking time becomes. Do not open the appliance door; this distorts the estimated cooking time. The display shows the estimated cooking time in manual operation and in the automatic program.

To display the current core temperature, press on the set core temperature.

18 Home Connect

This appliance is network-capable. Connecting your appliance to a mobile device lets you control its functions via the Home Connect app, adjust its basic settings and monitor its operating status.

The Home Connect services are not available in every country. The availability of the Home Connect function depends on the availability of the Home Connect services in your country. You can find information about this at: www.home-connect.com.

The Home Connect app guides you through the entire login process. Follow the instructions, noting the information in the Home Connect app.

Notes

- Please note the safety precautions in this instruction manual and make sure that they are also observed when operating the appliance via the Home Connect app.
→ "Safety", Page 2
- Operating the appliance on the appliance itself always takes priority. During this time it is not possible to operate the appliance using the Home Connect app.
- In networked standby mode, the appliance requires a maximum of 2 W.

18.1 Setting up Home Connect

Requirements

- The appliance is connected to the power supply and is switched on.
- You have a mobile device with a current version of the iOS or Android operating system, e.g. a smartphone.
- The appliance is receiving signals from the WLAN home network (Wi-Fi) at its installation location.
- The mobile device and the appliance are within range of your home network's Wi-Fi signal.

1. Scan the following QR code.



You can install the Home Connect app and connect your appliance via the QR code.

2. Follow the instructions in the Home Connect app.

18.2 Home Connect Settings

You can adjust the home network settings in your appliance's basic settings.

Which settings the display shows will depend on whether Home Connect has been set up and whether the appliance is connected to your home network. You can switch the network connection on or off as required. The network information is retained after the appliance is switched off. After switching on the appliance, wait for a few seconds until it reconnects to the home network.

The display uses different symbols to show the connection strength to the router.

Note: In networked standby mode, the appliance requires a maximum of 2 W.

You can use the Home Connect app to access the appliance's functions. If you select the "Off (monitoring only)" setting in the basic settings → *Page 33* for "Remote start", the Home Connect app only shows the appliance's operating status and you can configure the settings.

If you select the "Permanent" setting in the basic settings → *Page 33* for "Remote start", you can start and operate your appliance at any time without any prior approval on the appliance.

If you select the "Manual" setting in the basic settings → *Page 33* for "Remote start", the appliance requires approval in the control centre in order to start a function. In the basic settings → *Page 33*, you can use "Network information" to display the network information.

In the basic settings → *Page 33*, you can use "Network credentials reset" to delete all network access data from the appliance at any time.

18.3 Starting functions with the Home Connect app via manual "Remote start"



You can use the Home Connect app to set the appliance remotely via the "Remote start" function. If you select the "Manual" setting in the basic settings for "Remote start", the appliance requires approval in the control centre in order to start a function.

WARNING – Risk of fire!

Combustible objects that are left in the cooking compartment may catch fire.

- ▶ Never store combustible objects in the cooking compartment.
- ▶ If smoke is emitted, the appliance must be switched off or the fuse must be switched off and the door must be held closed in order to stifle any flames.

Requirements

- The appliance is connected to the home network and to the Home Connect app.
 - To start a function, the "Manual" setting is selected in the basic settings for "Remote start".
1. To activate manual remote start, press  and then .
 2. Configure a setting in the Home Connect app and send it to the appliance.
 3. Start a function.

Note: If you open the appliance door more than 15 minutes after activating remote start or after the

operation ends, the appliance deactivates the manual remote start.

24 hours after activating remote start, the appliance deactivates the manual remote start.

18.4 Starting functions with the Home Connect app via permanently activated "Remote start"

You can use the Home Connect app to set and start the appliance remotely via the "Remote start" function. If you select the "Permanent" setting in the basic settings for "Remote start", the appliance does not require approval in the control centre in order to start a function.

WARNING – Risk of fire!

Combustible objects that are left in the cooking compartment may catch fire.

- ▶ Never store combustible objects in the cooking compartment.
- ▶ If smoke is emitted, the appliance must be switched off or the fuse must be switched off and the door must be held closed in order to stifle any flames.

Requirements

- The appliance is connected to the home network and to the Home Connect app.
 - To start a function, the "Permanent" setting is selected in the basic settings for "Remote start".
1. Configure a setting in the Home Connect app and send it to the appliance.
 2. Start a function.

18.5 Using the Home Connect app to change settings

You can use the Home Connect app to set the appliance remotely.

WARNING – Risk of fire!

Combustible objects that are left in the cooking compartment may catch fire.



- ▶ Never store combustible objects in the cooking compartment.
- ▶ If smoke is emitted, the appliance must be switched off or the fuse must be switched off and the door must be held closed in order to stifle any flames.

Requirement: The appliance is connected to the home network and to the Home Connect app.

- ▶ Configure a setting in the Home Connect app and send it to the appliance.

18.6 Switching the Wi-Fi on or off

Requirement: The On and "Off" settings are only available if a connection to the Home Connect server has been established.

1. Press  in the status bar.
2. Press  in the control centre.
3. Press the required setting.
4. If required, press < to switch to the "Settings" appliance display.

18.7 Displaying the "Long-term timer" function with the Home Connect app

Requirement: The appliance is connected to Home Connect.

- ▶ Display or hide the "Long-term timer" function under "Settings" in the Home Connect app under "Additional settings".
- ✓ Under "Type of heating", the Home Connect app shows two options for the "Long-term timer" function.

Note: The appliance display shows the "Long-term timer" function under "Modes & Service".

18.8 Deactivate the "Long-term timer" function with programmed start time using the Home Connect app

Requirements

- The appliance is connected to Home Connect.
- A start time in the future is programmed on the appliance for the "Long-term timer" function.
- The programmed start time for the "Long-term timer" function has not yet been reached.
- ▶ Deactivate the "Long-term timer" function under "Settings" in the Home Connect app under "Additional settings".
- ✓ The "Long-term timer" function does not start.

18.9 Starting the "Long-term timer" function using the Home Connect app

The "Long-term timer" function is available in the Home Connect app. In the Home Connect app, you can start the "Long-term timer" function with "Hot air" or without a heating cycle. A time-delayed start and the configuration of multiple heating cycles is not possible via the Home Connect app.

Requirement: In the Home Connect app, the "Long-term timer" function is activated under "Additional settings".

→ *"Displaying the 'Long-term timer' function with the Home Connect app", Page 33*

1. Under "Type of heating", select the "Long-term timer" function with "Hot air" or without a heating cycle.
2. Press "Next".
3. For a heating cycle with "Hot air", select the temperature and press "Next".
4. Select the time period.
5. Press "Done".
6. Press "Start".

18.10 Software update

Your appliance's software can be updated using the software update function, e.g. for the purposes of optimisation, troubleshooting or security updates.

To do this, you must be a registered Home Connect user, have installed the app on your mobile device and be connected to the Home Connect server.

As soon as a software update is available, you will be informed via the Home Connect app and will be able to start the software update via the app. Once the update has been successfully downloaded, you can start installing it via the Home Connect app if you are in your home network (Wi-Fi). The Home Connect app informs you once installation is successful.

You can find the current software version in the Home Connect app under the appliance information for the appliance.

Notes

- The software update consists of two steps.
 - The first step is the download.
 - The second step is the installation on your appliance.
- You can continue to use your appliance as normal while updates are downloading. Depending on your personal settings in the app, software updates can also be set to download automatically.
- Installation takes a few minutes. You cannot use your appliance during installation.
- We recommend that you install security updates as soon as possible.

18.11 Data protection

Please see the information on data protection.

The first time your appliance is registered on a home network connected to the Internet, your appliance will transmit the following types of data to the Home Connect server (initial registration):

- Unique appliance identification (consisting of appliance codes as well as the MAC address of the installed Wi-Fi communication module).
- Security certificate of the Wi-Fi communication module (to ensure a secure data connection).
- The current software and hardware version of your appliance.
- Status of any previous resetting to factory settings.

This initial registration prepares the Home Connect functions for use and is only required when you want to use the Home Connect functions for the first time.

Note: Please note that the Home Connect functions can only be utilised with the Home Connect app. Information on data protection can be retrieved in the Home Connect app.

19 Basic settings

You can configure the basic settings for your appliance to meet your needs.

19.1 Overview of the basic settings



Here you can find an overview of the basic settings and factory settings. The basic settings depend on the features of your appliance.

Symbol	Basic setting	Setting	Selection	Use
	Home network	WiFi	<ul style="list-style-type: none"> ■ On ■ Off¹ 	<p>Switches the Wi-Fi on or off</p> <p>Note: The On and Off settings are only available if a connection to the Home Connect server has been established.</p> <p>All settings are retained after the appliance is switched off. Switch on the Wi-Fi in order to allow the appliance to be controlled via the app and to use additional appliance functions.</p>
		Home Connect assistant	<ul style="list-style-type: none"> ■ During the initial connection to the Home Connect app: "Start" ■ If you have already connected successfully to the Home Connect app: "Connect now" 	Setting up Home Connect → <i>Page 31</i>
		Remote start	<ul style="list-style-type: none"> ■ Off (monitoring only) ■ Manual¹ ■ Permanent <p>Note: The settings are only available if you have selected the "On" setting for Wi-Fi.</p>	Setting "Remote start" → <i>"Starting functions with the Home Connect app via manual 'Remote start'", Page 32</i>
		Network information	<ul style="list-style-type: none"> ■ MAC address ■ Wi-Fi SSID ■ IPv4 address ■ IPv6 address <p>Note: The settings are only available if you have selected the "On" setting for Wi-Fi.</p>	Displaying "Network information"
		Network credentials reset	<ul style="list-style-type: none"> ■ Confirm <p>The connections are reset. The appliance deletes saved network access data.</p> <p>Note: The settings are only available if you have selected the "On" setting for Wi-Fi.</p>	Resetting the network access data





¹ Factory setting (may vary according to model)

Symbol	Basic setting	Setting	Selection	Use
	Display	Brightness	<ul style="list-style-type: none"> ▪ 1 ▪ 2 ▪ 3 ▪ 4¹ ▪ 5 ▪ 6 	Sets the brightness in stages
		Distant view	<ul style="list-style-type: none"> ▪ "On"¹: The display shows less content if you are at a greater distance. ▪ "Off": The display always shows the same content. 	Switching the remote view on or off
		Screen in off-mode	<ul style="list-style-type: none"> ▪ GAGGENAU logo"displayed on approach"¹ ▪ None 	Sets the low power mode display → <i>Page 13</i>
		Ring behaviour	<ul style="list-style-type: none"> ▪ "Standard": Press the required function and use the control ring to change the function ▪ "Quick selection"¹: Use the control ring to change the function located above the control ring 	Sets the control ring behaviour
		Display child lock	<ul style="list-style-type: none"> ▪ "On"¹: The symbol for the "Display child lock" function is only visible in the status bar if the "Display child lock" function is active. Control ring and touch fields are locked. ▪ "Off": The "Display child lock" function cannot be activated. 	Displaying or hiding the symbol for the child lock → <i>Page 25</i> in the control centre
		Door lock	<ul style="list-style-type: none"> ▪ Activated ▪ Off¹ 	Activates or deactivates the door lock Note: The door lock → <i>Page 14</i> prevents the appliance door from being opened accidentally. This is particularly useful when installing the appliance under the worktop.
		Display alignment	<ul style="list-style-type: none"> ▪ Vertical¹ ▪ Horizontal 	Aligns the display horizontally or vertically depending on the appliance's installation position or the user's body size

¹ Factory setting (may vary according to model)

Symbol	Basic setting	Setting	Selection	Use
	Sounds	Switch-on/switch-off sounds	<ul style="list-style-type: none"> ▪ Quiet ▪ Standard ¹ ▪ Loud 	Set the volume of the on/off tones
		Notification sounds	<ul style="list-style-type: none"> ▪ Off ▪ Quiet ▪ Standard ¹ ▪ Loud 	Sets the volume of the notification tones Note: The notification tones for the warnings and error messages always remain switched on.
		Process sounds	Volume <ul style="list-style-type: none"> ▪ Off ▪ Quiet ▪ Standard ¹ ▪ Loud "Repetitions": <ul style="list-style-type: none"> ▪ 1x ▪ "10 s": The appliance emits the signal tone repeatedly for 10 seconds. ▪ "30 s" ¹: The appliance emits the signal tone repeatedly for 30 seconds. ▪ "3 min": The appliance emits the signal tone repeatedly for 3 minutes. "Preheating signal": <ul style="list-style-type: none"> ▪ "On" ¹ ▪ Off 	<ul style="list-style-type: none"> ▪ Set the volume of the process tones ▪ Set the required maximum duration of the process tones ▪ Activates or deactivates the process tone following pre-heating
		Visual feedback	<ul style="list-style-type: none"> ▪ On ▪ Off ¹ 	Switches the pulsating light for programme end, notifications or error messages on or off
		Volume reduction	<ul style="list-style-type: none"> ▪ "On": Lower the volume for all tones to a certain volume level in a defined period ▪ "Reduced": Lower the volume for all tones to the "Quiet" volume level in a defined period and switch off the tones for cleaning ▪ "Off" ¹: Switch off all tones in a defined period Start time <ul style="list-style-type: none"> ▪ "22h" ¹ End time <ul style="list-style-type: none"> ▪ "7h" ¹ 	Sets the lowering of the volume Note: The signal tones for warnings, error messages and switching on and switching off always remain switched on.
	Interior lighting	Brightness	<ul style="list-style-type: none"> ▪ Dark ▪ Standard ¹ ▪ Bright 	Sets the brightness of the interior lighting

¹ Factory setting (may vary according to model)

Symbol	Basic setting	Setting	Selection	Use
		Activation	<ul style="list-style-type: none"> ▪ Automatic ¹ ▪ Manual 	Switches the interior lighting → <i>Page 8</i> on automatically or manually
		Light interaction	<ul style="list-style-type: none"> ▪ On ¹ ▪ Off 	Sets the light interaction Note: If you are outside of the range that the appliance recognises, the appliance reduces the interior lighting to what is essential.
	Notifications	Info-i	<ul style="list-style-type: none"> ▪ On ¹ ▪ Off 	Displays or hides additional information Tip: If you press  , the display shows additional information → <i>Page 13</i> . If you switch off the function, the display does not show any symbols or any additional information.
		Pop-up hints	<ul style="list-style-type: none"> ▪ On ¹ ▪ Off 	Displays or hides the pop-up notifications → <i>Page 13</i>
		Hidden notifications	Restore	Displays hidden notifications again
	Language	-	<ul style="list-style-type: none"> ▪ Deutsch ▪ French ▪ [...] ▪ English ¹ 	Setting the language
	Time & Units	Time	<ul style="list-style-type: none"> ▪ Time ¹ ▪ "Automatic": Select the "Automatic" option if your appliance is connected to Home Connect. 	Setting the time
		Time format	<ul style="list-style-type: none"> ▪ 12 ▪ 24 ¹ 	Set the time format
		Temperature unit	<ul style="list-style-type: none"> ▪ °C ¹ ▪ °F 	Set the temperature unit
		Weight unit	<ul style="list-style-type: none"> ▪ "Metric": "g/kg" ▪ "Anglo-american": "oz/lb" 	Set the weight unit
	Advanced	Display long-term timer	<ul style="list-style-type: none"> ▪ On ▪ Off ¹ 	Displays or hides the "Long-term timer" function
		Demo mode	<ul style="list-style-type: none"> ▪ On ▪ Off ¹ 	Activates or deactivates demo mode Note: The setting is only available in the first 3 minutes after connecting to the power supply.

¹ Factory setting (may vary according to model)

Symbol	Basic setting	Setting	Selection	Use
		Factory settings	<ul style="list-style-type: none"> ▪ Restore 	<p>Allows you to restore the appliance's factory settings</p> <p>Note: The appliance starts the initialisation. The display asks you to specify settings that the appliance installer has implemented.</p>
	Appliance	Start screen	<ul style="list-style-type: none"> ▪ Microwave ¹ ▪ Manual ▪ Favourites ▪ Programmes 	<p>Select a display that shows the display after switching on</p> <p>"Manual" corresponds to oven mode.</p>
		Food preference	<ul style="list-style-type: none"> ▪ Off ¹ ▪ Vegetarian ▪ No meat & poultry ▪ No fish & seafood ▪ No pork ▪ Kosher 	<p>Selects the preferred food for automatic programmes and setting recommendations</p>
		Automatic resume microwave	<ul style="list-style-type: none"> ▪ On ▪ Off ¹ 	<p>If the door is opened while the microwave is running, the appliance continues to run automatically as soon as the door is closed again.</p>
		Count-up cooking timer	<ul style="list-style-type: none"> ▪ On ¹ ▪ Off 	<p>Sets the count-up cooking timer</p> <p>Note: The running cooking time is automatically counted up if no cooking time has been stored.</p>
		User detection	<p>"Behaviour":</p> <ul style="list-style-type: none"> ▪ Automatic ▪ "Below 1.2 m"- "Below 0.1 m" <p>"Installation height":</p> <ul style="list-style-type: none"> ▪ Under 91.4 cm/36" ▪ Between 91.4 cm/36" and 150 cm/59" ¹ ▪ Over 150 cm/59" 	<ul style="list-style-type: none"> ▪ Sets the distance from which the proximity sensor detects the user ▪ Sets the appliance's installation height <p>Note: To ensure that the proximity sensor optimally detects the user, store the installation height of the appliance's upper edge.</p>
		Introduction to the appliance	Start	<p>Starting the appliance introduction</p> <p>Note: The appliance introduction contains a short description of the basic functions.</p>

¹ Factory setting (may vary according to model)

19.2 Changing the basic settings

1. Swipe repeatedly from left to right until the display shows Basic settings → *Page 33*.
- ✓ The display shows the symbols for the available settings in a ring menu.
2. Use the control ring to select the required basic setting.
3. Press the required basic setting.
- ✓ The display shows the settings for the selected basic setting.

4. Depending on the selected basic setting, use the control ring to select the setting or press the required setting.
 - ▶ With a list menu, ensure that the required setting is above the horizontal line.
5. Use \rightarrow to activate the setting or use the control ring to select the setting option and press the setting.
6. If required, use < to switch to the previous view.

20 Cleaning and servicing

20.1 Cleaning products

To avoid damaging the various surfaces on the appliance, do not use any unsuitable cleaning agents.

⚠ **WARNING – Risk of electric shock!**

An ingress of moisture can cause an electric shock.

- ▶ Do not use steam- or high-pressure cleaners to clean the appliance.

⚠ **WARNING – Risk of burns!**

The appliance and its parts that can be touched become hot during use.

- ▶ Caution should be exercised here in order to avoid touching heating elements.
- ▶ Young children under 8 years of age must be kept away from the appliance.

⚠ **WARNING – Risk of injury!**

Scratched glass in the appliance door may develop into a crack.

- ▶ Do not use any harsh or abrasive cleaners or sharp metal scrapers to clean the glass on the appliance door, as they may scratch the surface.

ATTENTION

Unsuitable cleaning agents damage the surfaces of the appliance.

- ▶ Do not use harsh or abrasive cleaning products.

Suitable cleaning agents

Only use cleaning agents that are suitable for the different surfaces on your appliance.

Appliance door

Range	Suitable cleaning agents	Information
Door panel	<ul style="list-style-type: none"> ▪ Glass cleaner 	Do not use a glass scraper. Clean it using a soft cloth or a microfibre cloth.
Control ring	<ul style="list-style-type: none"> ▪ Soapy water 	Clean with a slightly damp soft cloth. Do not spray with any cleaning agent.

Cooking compartment

Range	Suitable cleaning agents	Information
Cooking compartment inner walls	<ul style="list-style-type: none"> ▪ Hot soapy water 	Clean with a dishcloth and dry with a soft cloth. Stainless steel cleaner that is suitable for the appliance can be obtained from customer service or online. To prevent corrosion, remove any patches of limescale, grease, starch or albumin (e.g. egg white) from stainless steel surfaces immediately. Corrosion may form under such stains.

- ▶ Do not use cleaning products with a high alcohol content.
- ▶ Do not use hard scouring pads or cleaning sponges.
- ▶ Do not use any special cleaners for cleaning the appliance while it is hot.
- ▶ Only use glass cleaners, glass scrapers or stainless steel care products if recommended in the cleaning instructions for the relevant part.

Salt contained in new sponge cloths may damage surfaces.

- ▶ Wash new sponge cloths thoroughly before use.
- Using oven cleaner in a hot cooking compartment damages the stainless steel surfaces.
- ▶ Never use oven cleaner in the cooking compartment when it is still warm.
- ▶ Remove all food remnants from the cooking compartment and the appliance door before you next heat up the appliance.

⚠ **WARNING – Risk of fire!**

Loose food remnants, fat and meat juices may catch fire.

- ▶ Before using the appliance, remove the worst of the food residues and remnants from the cooking compartment, heating elements and accessories.

Range	Suitable cleaning agents	Information
		Do not use oven spray or other aggressive oven cleaners or abrasive materials. Scouring pads, rough sponges and pan cleaners are unsuitable. These items scratch the surface. Always dry the cooking compartment after cleaning. Note: Undissolved detergent causes patches to appear when heating up and these patches cannot be removed. Thoroughly remove residues from detergents or care products using clean water before drying the cooking compartment. Tip: To eliminate unpleasant odours, heat up a cup of water with a few drops of lemon juice for 1 to 2 minutes at maximum microwave power setting. Always place a spoon in the container to prevent delayed boiling.
Very dirty cooking compartment	▪ Cleaning aid	The cleaning aid → <i>Page 40</i> programme removes stubborn dirt.
Grill	▪ Hot soapy water	Clean with a dishcloth or sponge, and dry with a soft cloth.
Glass cover for the cooking compartment light	▪ Hot soapy water	Clean with a dishcloth.
Glass floor	▪ Hot soapy water ▪ Glass cleaner	Do not use a glass scraper. Clean with a soft dish cloth and dry with a soft cloth.
Shelf support	▪ Hot soapy water	Note: If required, remove the shelf supports for cleaning. → <i>"Removing the shelf supports", Page 40</i> In the event of heavy soiling, leave to soak and use a brush. Do not clean in the dishwasher.
Wire rack	▪ Hot soapy water	In the event of heavy soiling, leave to soak and use a brush. Do not clean in the dishwasher.
Glass tray	▪ Dishwasher ▪ Hot soapy water	Soak burnt-on residues and remove with a brush.
Core temperature probe	▪ Hot soapy water	Wipe with a damp cloth Do not clean in the dishwasher.

20.2 Microfibre cloth

The honeycomb microfibre cloth is especially suitable for cleaning easily damaged surfaces, such as glass, glass ceramic, stainless steel or aluminium. The microfibre cloth removes liquid and greasy deposits in one go.

The microfibre cloth can be obtained from customer service or from the online shop.

20.3 Removing the shelf supports

1. Place a dishcloth in the cooking compartment to protect the stainless steel from scratches.
2. Undo the knurled nuts.

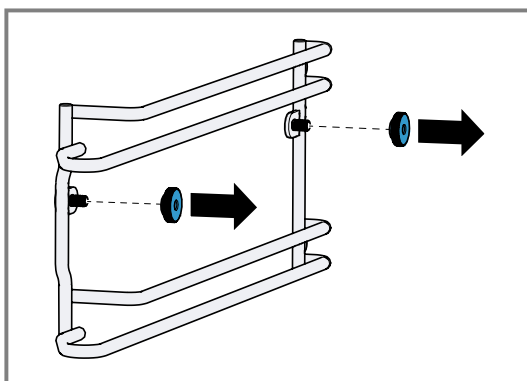

3. Lift the shelf supports slightly sideways away from the screws ① and pull them out towards the front ②.

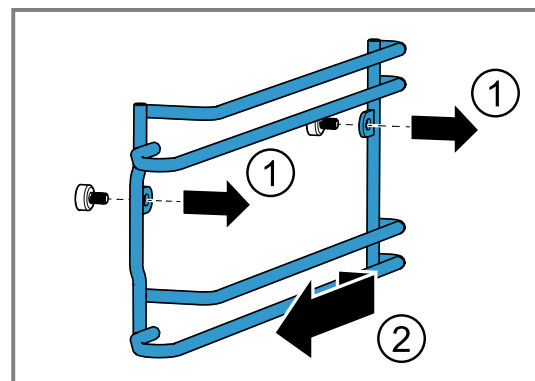

4. Clean the shelf supports with hot soapy water.

20.4 Cleaning aid

The cleaning aid loosens stubborn dirt in the cooking compartment and makes cleaning easier.

Always allow the cleaning aid to run to the end. You cannot cancel the cleaning aid.

Preparing the cleaning aid

Requirement: The interior temperature is below 40 °C.

1. Remove all accessories from the cooking compartment.

2. Remove the shelf supports from the cooking compartment. → *Page 40*
3. Clean the accessories and side shelf supports separately.
4. Wipe out any coarse dirt.
5. Apply a cleaning agent to dirty surfaces in the cooking compartment.
6. Place a microwave-safe dish with a drop of washing-up liquid and 200 ml of water in the middle of the cooking compartment.
7. Place a spoon in the dish to prevent delayed boiling.
8. Close the appliance door.

Starting the cleaning aid

Note: The appliance takes you through the necessary steps.

1. Swipe repeatedly from left to right until the display shows "Modes & Service".
- ✓ The display shows the available functions in a list menu.
2. Use the control ring to select the "Cleaning aid" function.
3. Press "Cleaning aid" in the list menu.
4. Switch to the next window with →.
5. Press ▶ to start.
- ✓ The cleaning time counts down.
- ✓ The light in the cooking compartment remains switched off.
- ✓ An audible signal will sound once the cleaning time has elapsed.
- ✓ The display shows a message.
6. Wipe out the cooking compartment.
7. Wipe the cooking compartment dry with a soft cloth.
8. Before using the oven again, remove any detergent residue from the cooking compartment.
9. Leave the cooking compartment to dry with the door open.
10. Fit the shelf supports. → *Page 41*
→ "Fitting the shelf supports", *Page 41*

Note: If the cleaning aid was cancelled due to a power cut, it must be restarted before using the oven again in order to remove any detergent residues from the appliance.

20.5 Fitting the shelf supports

⚠ WARNING – Risk of burns!

Loose knurled screws can become very hot during operation.

- ▶ Ensure that the knurled screws for installing the suspension grille are screwed in tightly.

ATTENTION

Loose knurled screws may cause sparks to form during microwave operation.

They damage the appliance by producing sparks.

- ▶ Ensure that the knurled screws for installing the shelf supports are screwed in tightly.

Incorrect spare parts may lead to corrosion in the cooking compartment.

- ▶ Only use the original knurled nuts.

1. Fit the shelf supports on the correct side of the cooking compartment.

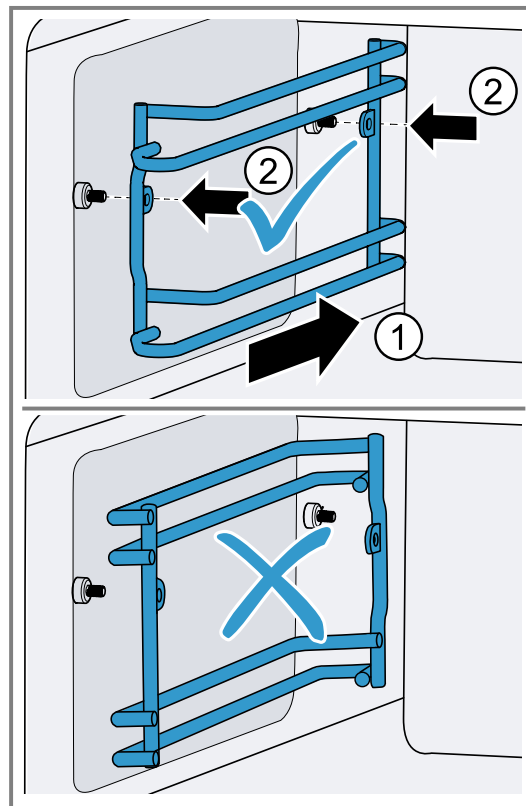

The shelf supports for the left and right side of the cooking compartment are different.

2. Tighten the knurled nuts.

Note: If you lose a knurled nut, you can order this as a spare part from our customer service.

20.6 Cleaning accessories

1. Read the information on cleaning products.
→ *Page 39*
2. Soften baked-on food remnants with a damp dish cloth and hot soapy water.
3. Clean the accessory with hot soapy water and a soft dish cloth or a scrubbing brush.
4. Clean the wire rack.
Use oven cleaner to remove very heavy soiling.
5. Dry with a soft cloth.

20.7 Cleaning the glass floor

1. Read the information on cleaning products.
→ *Page 39*
2. Clean the glass floor with hot detergent solution or a glass-cleaner and a soft dish cloth.
Do not use a glass scraper.
3. Dry with a soft cloth.

21 Troubleshooting

You can rectify minor faults on your appliance yourself. Read the troubleshooting information before contacting after-sales service. This will avoid unnecessary costs.

Tip: Permanently connect your appliance to the Home Connect app to automatically receive software updates. This allows errors to be eliminated, performance to be improved and new functions to be made available.

⚠ WARNING – Risk of injury!

Improper repairs are dangerous.

- ▶ Repairs to the appliance should only be carried out by trained specialist staff.
- ▶ If the appliance is defective, call Customer Service.
→ "Customer Service", Page 43

⚠ WARNING – Risk of electric shock!

Improper repairs are dangerous.

- ▶ Repairs to the appliance should only be carried out by trained specialist staff.
- ▶ Only use genuine spare parts when repairing the appliance.
- ▶ If the power cord or the appliance power cable of this appliance is damaged, it must be replaced with a special power cord or special appliance power cable, which is available from the manufacturer or its Customer Service.
- ▶ If the power cord of this appliance is damaged, it must be replaced by trained specialist staff.

21.1 Malfunctions

Fault	Cause and troubleshooting
The appliance is not working.	<p>The mains plug of the power cord is not plugged in.</p> <ul style="list-style-type: none"> ▶ Connect the appliance to the power supply. <hr/> <p>The circuit breaker in the fuse box has tripped.</p> <ul style="list-style-type: none"> ▶ Check the circuit breaker in the fuse box. <hr/> <p>There has been a power cut.</p> <ul style="list-style-type: none"> ▶ Check whether the lighting in your room or other appliances are working. <hr/> <p>Malfunction</p> <ol style="list-style-type: none"> 1. Switch off the fuse in the fuse box. 2. Switch the fuse on after approx. 10 seconds. 3. If the malfunction occurs again, call customer service.
Appliance does not start.	<p>Appliance door not fully closed.</p> <ul style="list-style-type: none"> ▶ Close appliance door.
The appliance cannot be started via the Home Connect app.	<p>The appliance is not connected to the Home Connect app.</p> <ul style="list-style-type: none"> ▶ Start the connection between the appliance and the Home Connect app. → "Setting up Home Connect", Page 31 <hr/> <p>The appliance is connected to the Home Connect app but the remote control function is not activated.</p> <ul style="list-style-type: none"> ▶ Activate the remote control function in the Home Connect settings → Page 32.
The display always shows the orange ring behind the control ring, even if you are not touching the control ring.	<p>During cleaning, too much moisture got behind the control ring.</p> <ol style="list-style-type: none"> 1. Wait until the moisture has evaporated. 2. If necessary, wait a few hours until the moisture has evaporated.
The display never shows the orange ring behind the control ring, even if you touch the control ring.	<p>During cleaning, too much moisture got behind the control ring.</p> <ol style="list-style-type: none"> 1. Wait until the moisture has evaporated. 2. If necessary, wait a few hours until the moisture has evaporated.
Food takes longer than usual to heat up.	<p>The microwave power setting is set too low.</p> <ul style="list-style-type: none"> ▶ Set a higher microwave output. → Page 18 <hr/> <p>A larger amount than usual has been placed in the appliance.</p> <ul style="list-style-type: none"> ▶ Set a longer cooking time. You need double the time when you have double the amount. <hr/> <p>The food is colder than usual.</p> <ul style="list-style-type: none"> ▶ Turn or stir the food from time to time during cooking.
The appliance does not work. The display does not respond. The display shows the symbol for the childproof lock  .	<p>Childproof lock is activated.</p> <ul style="list-style-type: none"> ▶ Deactivate the childproof lock. → Page 25

Fault	Cause and troubleshooting
The appliance automatically switches off.	Safety switch-off function: No operation for more than 12 hours. 1. Press ✓ to confirm the message. 2. Switch off the appliance.
The appliance does not heat up; the display shows the symbol for demo mode ✕.	The appliance is in demo mode. ▶ Deactivate the demo mode in the basic settings → <i>Page 33</i> .
The lighting does not work.	The lighting is defective. ▶ Call Customer Service → <i>Page 43</i> .

21.2 Information on display panel

Fault	Cause and troubleshooting
The display shows the error message "Exx".	An error occurred. 1. If the display shows an error message, press ⏻. ✓ If the display no longer shows the error message, it was a one-off problem. 2. If the display continues to show or repeatedly shows the error message, contact customer service → <i>Page 43</i> and provide them with the error code.
Display shows "Initialisation".	The initial start-up was not completed successfully. ▶ Carry out the initial start-up. → <i>"Initial start-up", Page 15</i>
	The appliance was restored to the factory settings. ▶ Carry out the initial start-up. → <i>"Initial start-up", Page 15</i>
	Demo mode was activated during initial start-up and has now been deactivated. ▶ Carry out the initial start-up. → <i>"Initial start-up", Page 15</i>

21.3 Power failure

Your appliance can bridge a power failure of a few seconds. The operation continues. If the power failure lasts longer and the appliance was operating, the display shows a message. The operation is interrupted.

Switch the appliance back on again after a power failure

1. Press ⏻.
2. Switch the appliance back on again as usual.

21.4 Demo mode

If the display shows ✕, demo mode is activated. The appliance does not heat up.

Deactivating demo mode

1. To briefly disconnect the appliance from the mains, switch off the household fuse or the circuit breaker in the fuse box.
2. Deactivate demo mode within 3 minutes in the basic settings → *Page 33*.

22 Disposal

22.1 Disposing of old appliance

Valuable raw materials can be reused by recycling.

- ▶ Dispose of the appliance in an environmentally friendly manner.
Information about current disposal methods are available from your specialist dealer or local authority.



This appliance is labelled in accordance with European Directive 2012/19/EU concerning used electrical and electronic appliances (waste electrical and electronic equipment - WEEE). The guideline determines the framework for the return and recycling of used appliances as applicable throughout the EU.

23 Customer Service

Function-relevant genuine spare parts according to the corresponding Ecodesign Directive can be obtained from Customer Service for a period of at least 10 years

from the date on which your appliance was placed on the market within the European Economic Area.

Furthermore, our Customer Service will continue to provide you with other function-relevant and storable genuine spare parts for up to 15 years from the date on which your appliance was placed on the market.

For more information, please contact our Customer Service team.

Note: Under the terms of the manufacturer's warranty the use of Customer Service is free of charge.

Detailed information about the warranty period and the warranty conditions in your country is available via the QR code on the enclosed document on service contacts and warranty conditions, from our customer service or on our website.

You can find the contact details for our customer service via the QR code on the enclosed document on service contacts and warranty conditions or on our website. This product contains light sources from energy efficiency class F. These light sources are available as a spare part and should only be replaced by trained specialist staff.

You can find the information required as per Regulation (EU) 2023/826 online at www.gaggenau.com on the

product and service pages for your appliance, in the area of user manuals and additional documents.

23.1 Product number (E-Nr.), production number (FD) and consecutive numbering (Z-Nr.)

If you contact Customer Service, you will require the product number (E-Nr.), the production number (FD) and the consecutive numbering (Z-Nr.), which you can find on the appliance's rating plate.

You will see the rating plate with these numbers if you open the appliance door.

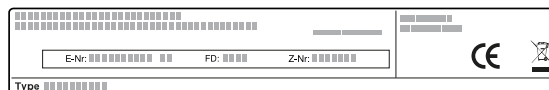

Make a note of your appliance's details and the Customer Service telephone number to find them again quickly.

24 How it works

Here, you can find the ideal settings for various dishes as well as the best accessories and cookware. We have perfectly tailored these recommendations to your appliance.

24.1 What is the best way to proceed?

Tip

Cooking tips

- The recommended settings always apply to the cooking compartment when it is cold and empty.
- The times specified in the overviews are intended as a guide only. They depend on the quality and composition of the food.

⚠ **WARNING – Risk of burns!**

Foods with peel or skin may burst or explode during heating, or even afterwards.

- ▶ Never cook eggs in their shell or heat hard-boiled eggs in their shell.
- ▶ Never cook shellfish or crustaceans.
- ▶ Always prick the yolk of eggs before microwaving.
- ▶ The skin of foods that have a peel or skin, such as apples, tomatoes, potatoes and sausages, may burst. Before heating, prick the peel or skin.

ATTENTION

Acidic food may damage the wire rack

- ▶ Do not place acidic food, such as fruit or food with an acidic marinade directly on the wire rack.

Note: Information for those allergic to nickel

In rare cases, small amounts of nickel may pass into the food.

1. Before using the appliance, remove all unnecessary cookware from the cooking compartment.
2. Select the desired food from the recommended settings.
3. Place the food in suitable cookware.

4. Place the cookware in the middle on the cooking compartment floor.
The food can then absorb the microwaves from all sides.
5. Use the recommended settings when configuring the appliance settings.
Set the shorter cooking time first. If necessary, increase the cooking time.
6. Use a pot-holder when taking hot cookware out of the cooking compartment.

24.2 General cooking tips

Take note of the following information when cooking all types of food.

- The cooking times specified are intended as a guide. The actual cooking time depends on the quality and temperature of the food before cooking, as well as its weight and thickness.
- Use the cookware specified. If you use other cookware, the cooking time may be longer or shorter.
- Always use plates, baking tins or ovenproof dishes with the wire rack.
- If you have not made a particular dish before, start with the shortest specified time. If required, you can continue to cook the food.
- Open the cooking compartment door on the pre-heated oven for a short time only and quickly place your food inside the appliance.
- When defrosting, dough-proving and reheating, you can use up to 2 shelf levels at a time (shelf levels 1 and 2). The specified cooking times may need to be extended for large quantities of food.
- If you are baking on just one level, use level 1.
- Ensure that the food does not lie against the cooking compartment or the back panel.
- When cooking at temperatures up to 100 °C, no pre-heating is necessary. Place the food in the cold cook-

ing compartment and then switch on the appliance. Preheating is only necessary for the "Hot air" type of heating and temperatures above 100 °C.

24.3 Test dishes

These overviews have been produced for test institutes to facilitate appliance testing in accordance with EN 60350-1:2013 or IEC 60350-1:2011 and EN 60705:2012, IEC 60705:2010.





Defrosting with the microwave

Observe the recommended settings for defrosting food and dishes.

Food	Accessory/ cookware	Level	Microwave output	Type of heating	Temperature in °C	Cooking time in mins	Comments
Raspberries, 250 g	Microwave- safe cook- ware	0	180 W		-	6-10	



Cooking with the microwave

Observe the recommended settings for using the microwave to cook food.

Food	Accessory/ cookware	Level	Microwave output	Type of heating	Temperature in °C	Cooking time in mins	Comments
Egg wash, 1 kg	Microwave- safe cook- ware	0	1. 600 2. 90		-	1. 14-16 2. 50-55	
Sponge, 475 g	Microwave- safe cook- ware	0	600		-	8-10	
Meat loaf, 900 g	Microwave- safe cook- ware	0	600		-	20-25	
Minced meat, 500 g	Microwave- safe cook- ware	0	1. 180 2. 90		-	1. 8-10 2. 8-12	





Cooking with the microwave and grill

Observe the recommended settings for using the microwave to grill food.

Food	Accessory/ cookware	Level	Microwave output	Type of heating	Temperature in °C	Cooking time in mins	Comments
Potato gratin, 1.1 kg	Microwave- safe cook- ware	0	360W		220	25-30	
Chicken, 1.2 kg	Microwave- safe cook- ware	1	360W		180	30-35	

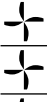
Baking

Note the recommended settings for baking.

Food	Accessory/ cookware	Level	Microwave output	Type of heating	Temperature in °C	Cooking time in mins	Comments
Cake, 925 g	Microwave- safe cook- ware	1	180 W +		190	20-25	Preheat.
Shortbread	Glass tray	1	-		140	50	Preheat.
Shortbread	Glass tray	2+1	-		140	50	Preheat.
Small cakes	Glass tray	1	-		160	30	Preheat.
Small cakes	Glass tray	2+1	-		150	40	Preheat.

Food	Accessory/ cookware	Level	Microwave output	Type of heating	Temperature in °C	Cooking time in mins	Comments
Water sponge cake	Springform tin	1	-	+	150	35	Preheat.
Apple cake	Springform tin	1	-	+	170	90	Preheat.

Grilling

Observe the recommended settings for using the microwave to grill food.

Food	Accessory/ cookware	Level	Microwave output	Type of heating	Temperature in °C	Cooking time in mins	Comments
Toasting bread	Pan support	2	-	☰ +	230	8-10	
Beef burger, 12 pcs	Wire rack + glass tray	2+1	-	☰ +	230	30	

25 Information regarding Free and Open Source Software

This product includes software components that are licensed by the copyright holders as free software or open source software.

The applicable licence information is stored on your home appliance. You can also access the applicable licence information via your Home Connect app: "Profile -> Legal information -> Licence Information".¹ You can also download the licence information on the brand product website. (Please search on the product website for your appliance model and additional documents). Alternatively, you can request the relevant information

from ossrequest@bshg.com or BSH Hausgeräte GmbH, Carl-Wery-Str. 34, 81739 Munich, Germany.

The relevant source code will be made available on request.

Please send your request to ossrequest@bshg.com or BSH Hausgeräte GmbH, Carl-Wery-Str.34, 81739 Munich, Germany.

Subject: „OSSREQUEST“

The cost of performing your request will be charged to you. This offer is valid for three years from the date of purchase or at least as long as we offer support and spare parts for the relevant appliance.

26 Declaration of Conformity

BSH Hausgeräte GmbH hereby declares that the appliance with Home Connect functionality conforms to the essential requirements and other relevant provisions of Directive 2014/53/EU.

A detailed RED Declaration of Conformity can be found online at www.gaggenau.com among the additional documents on the product page for your appliance.



Hereby, BSH Hausgeräte GmbH declares that the appliance with Home Connect functionality is in compliance with relevant statutory requirements.²

A detailed Declaration of Conformity can be found online at www.gaggenau.com/gb among the additional documents on the product page for your appliance.²



2.4 GHz band (2400–2483.5 MHz): Max. 100 mW

5-GHz band (5150–5350 MHz + 5470–5725 MHz): max. 150 mW

	BE	BG	CZ	DK	DE	EE	IE	EL	ES
	FR	HR	IT	CY	LI	LV	LT	LU	HU

¹ Depending on the appliance specifications

² Only applies to Great Britain

MT	NL	AT	PL	PT	RO	SI	SK	FI
SE	NO	CH	TR	IS	UK (NI)			

5 GHz WLAN (Wi-Fi): For indoor use only.

AL	BA	MD	ME	MK	RS	UK	UA
----	----	----	----	----	----	----	----

5 GHz WLAN (Wi-Fi): For indoor use only.

26.1 Statement of Compliance for Great Britain

Product type

This statement of compliance covers the products described in this information for use whose model identifier group is seen on the title page. The full model identifier is made up of the characters before the slash in the product number (E no.) which can be found on the rating plate. Alternatively, you can also find the model identifier in the first line of the UK Energy Label.

Name and address of manufacturer

BSH Hausgeräte GmbH, Carl-Wery-Strasse 34, 81739 München, Germany

This statement of compliance is prepared by the manufacturer.

The manufacturer, BSH Hausgeräte GmbH deems that it has complied with

- provision 5.1-1 of ETSI EN 303 645 v2.1.1 and, where relevant, provision 5.1-2 of ETSI EN 303 645 v2.1.1;
- provision 5.2-1 of ETSI EN 303 645 v2.1.1;
- provision 5.3-13 of ETSI EN 303 645 v2.1.1.

Support period

BSH Hausgeräte GmbH will provide security updates that are necessary to maintain the main functions free of charge until at least 28/02/2034.

27 Installation instructions

Observe this information when installing the appliance.

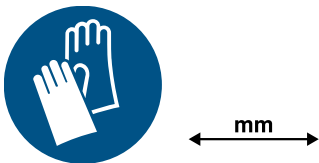

27.1 Safe installation

Follow these safety instructions when installing the appliance.

- The appliance can only be used safely if it is correctly installed according to the safety instructions. The installer is responsible for ensuring that the appliance works perfectly at its installation location.
- Check the appliance for damage after unpacking it. Do not connect the appliance if it has been damaged in transit.
- Before starting up the appliance, remove any packaging material and adhesive film from the cooking compartment and the door.
- Proceed in accordance with the installation sheets for installing accessories.
- Fitted units must be heat-resistant up to 95 °C, and adjacent unit fronts up to 70 °C.
- Do not install the appliance behind a decorative door or the door of a kitchen unit. There is a risk of overheating.
- Cut-out work on the units should be carried out before installing the appliance. Remove any shavings. Otherwise, the correct opera-

tion of electrical components may be adversely affected.

- Only a licensed professional may connect appliances without plugs. Damage caused by incorrect connection is not covered under the warranty.
- Do not lift the appliance using the door or the appliance frame.

WARNING – Risk of injury!

Parts that are accessible during installation may have sharp edges and may lead to cutting injuries.

- ▶ Wear protective gloves.

WARNING – Risk of fire!

It is dangerous to use an extended power cord and non-approved adapters.

- ▶ Do not use extension cables or multiple socket strips.
- ▶ Only use adapters and power cords approved by the manufacturer.
- ▶ If the power cord is too short and a longer one is not available, please contact an electrician to have the domestic installation adapted.

WARNING – Risk of injury!

The appliance is heavy.

- ▶ To move the appliance, two people are required.
- ▶ Use only suitable tools and equipment.

ATTENTION

Carrying the appliance by the appliance frame may cause it to bend. The appliance frame cannot support the weight of the appliance.

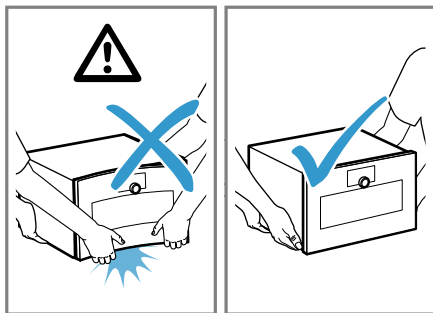

- ▶ Do not lift the appliance using the appliance frame.
- ▶ Always lift the appliance at the casing.

⚠ WARNING – Risk of electric shock!

Incorrect installation is dangerous.

- ▶ Connect and operate the appliance only in accordance with the specifications on the rating plate.
- ▶ Connect the appliance to a power supply with alternating current only via a properly installed socket with earthing.
- ▶ The protective conductor system of the domestic electrical installation must be properly installed.
- ▶ Never equip the appliance with an external switching device, e.g. a timer or remote control.
- ▶ When installing the appliance, check that the power cable is not trapped or damaged.

ATTENTION

Surface damage caused by pulling or pushing the appliance.

- ▶ Do not pull or push the appliance; lift it instead.
- ▶ Place a tea towel under the appliance.

27.2 QR code for the installation video

This is where you will find the QR code for the installation video.



27.3 Planning notes

Observe the following planning notes before installing the appliance.

- The door direction cannot be reversed.
- The distance from the furniture cavity to the door panel surface is 42 mm.
- Consider the overhang when planning to open drawers next to the appliance.
- When planning a corner solution, consider a door opening angle of at least 97°.
- When installing above a fully automatic coffee machine, use the intermediate floor or the metal bracket. You can obtain the intermediate floor and the metal bracket from after-sales service or the online shop.
- When installing two appliances above each other directly beside a fully automatic coffee machine, use the intermediate floor or the metal bracket between the four appliances.
- The appliance's mains socket must be located outside of the built-in niche.

27.4 Scope of delivery

After unpacking all parts, check for any damage in transit and completeness of the delivery.

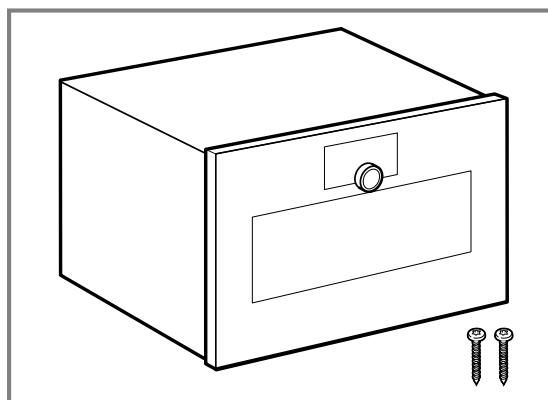

27.5 Appliance dimensions

You will find the dimensions of the appliance here

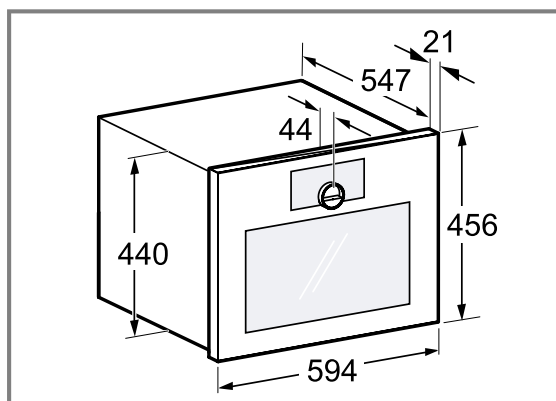

27.6 Installation accessories

Use original accessories.

Accessories	Order number
Intermediate floor	GA601010

27.7 Preparing the units

This appliance is only intended to be fully fitted in a kitchen. It is not intended to be used as a tabletop appliance.

Requirement: Fitted units must be heat-resistant up to 90 °C, and adjacent unit fronts up to 70 °C.

1. Ensure that the mains socket is located outside of the built-in niche.
2. Carry out cut-out work on the units and then insert the appliance.
3. After making the cut-outs, remove any shavings. Shavings may impair the function of electrical components.
4. Secure any unsecured units to the wall using a standard bracket.
5. Install the appliance only so high that the customer can remove any accessories effortlessly.
6. Do not cover the ventilation slots and air intake openings.
7. Remove the rear wall of the fitted cupboard behind the appliance or provide a sufficient cut-out in the intermediate floor.
8. Maintain a clearance of at least 45 mm between the wall and the cupboard base or the rear panel of the furniture situated above.

27.8 Electrical connection

In order to safely connect the appliance to the electrical system, follow these instructions.

⚠ WARNING – Risk of electric shock!

It must always be possible to disconnect the appliance from the electricity supply. The appliance must only be connected to a protective contact socket that has been correctly installed.

- ▶ The mains plug for the mains power cable must be easily accessible after the appliance is installed.
- ▶ If this is not possible, an all-pole isolating switch must be integrated into the permanent electrical installation

according to the conditions of overvoltage category III and according to the installation regulations.

- ▶ The permanent electrical installation must only be wired by a professional electrician. We recommend installing a residual-current circuit breaker (RCCB) in the appliance's power supply circuit.
- Improper repairs are dangerous.
- ▶ Repairs to the appliance should only be carried out by trained specialist staff.
 - ▶ Only use genuine spare parts when repairing the appliance.
 - ▶ If the power cord or the appliance power cable of this appliance is damaged, it must be replaced with a special power cord or special appliance power cable, which is available from the manufacturer or its Customer Service.
 - ▶ If the power cord of this appliance is damaged, it must be replaced by trained specialist staff.

- The appliance corresponds to protection class I and must only be operated with a protective earth connection.
- The fuse protection must correspond to the power rating specified on the appliance's rating plate and to local regulations.
- The appliance must be disconnected from the power supply whenever installation work is being carried out.
- The appliance must only be connected using the power cable provided. Fully connect the power cord to the back of the appliance.
- The power cord must only be replaced with a cord from the original manufacturer. The power cable can be obtained from customer service.
- Contact protection must be ensured by the installation.

Power cable with a plug with earthing contact

For an appliance with a plug with earthing contact, follow these instructions.

- Connect the appliance only to a correctly installed, earthed socket.
- If the plug with earthing contact can no longer be accessed after installation, an energy-isolating device in the phases must be provided in the permanent electrical installation in accordance with the installation regulations.
- Do not use extension cables, socket strips or multiple socket strips. Overloading leads to a risk of fire.

Power cable without a plug with earthing contact

For an appliance without a plug with earthing contact, follow these instructions.

Note: Only a licensed professional may connect appliances without plugs. Damage caused by incorrect connection is not covered under the warranty.

An isolating switch must be integrated into the permanent electrical installation according to the installation regulations.

Connecting a power cord without a plug with earthing contact

1. Identify the phase (external conductor) and neutral conductor in the mains socket.
The appliance may be damaged if it is not connected correctly.
2. Observe the specifications on the rating plate.
3. Connect the wires of the mains power cable according to the colour coding:
 - GN/YE: Green and yellow = Conductor ⊕
 - BU: Blue = Neutral conductor
 - BN: Brown = Phase (external conductor)

27.9 Installing the appliance in a tall unit

ATTENTION

The control panel may be damaged by setting it down on the floor.

- ▶ Never place appliances on the floor with the control panel at the bottom. Underlay with wooden strips.
- ▶ Never raise appliances sloping from the rear with the control panel at the bottom.

Note: The red label sticking out of the appliance door provides support during installation. Before connecting to the mains, pull on the red label to open the appliance door.

1. Observe the clearances when installing in a tall unit.
 - ▶ To ventilate the appliance, the intermediate floor must have a ventilation cut-out.
 - ▶ Do not fit the appliance too high up; it must be possible for accessories to be removed easily.

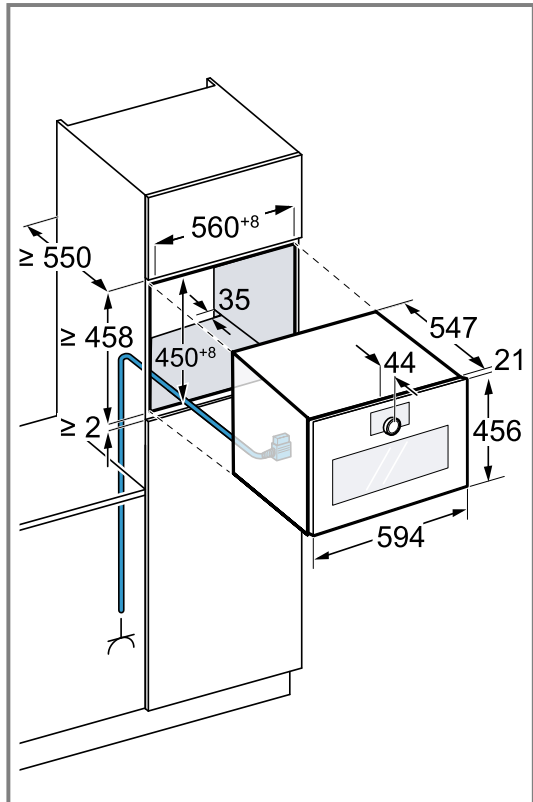

Depending on the product variant, the appliance is equipped with or without a plug.

2. When installing beside a wall, ensure that the potential opening angle of the appliance door is based on the minimum clearances to the wall.

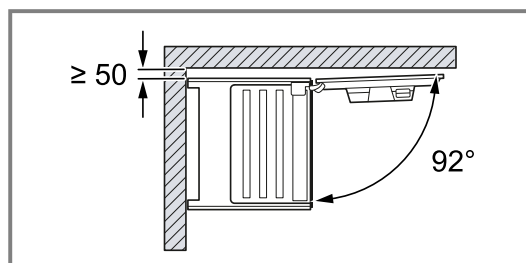
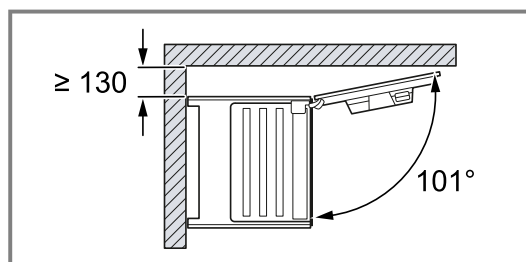
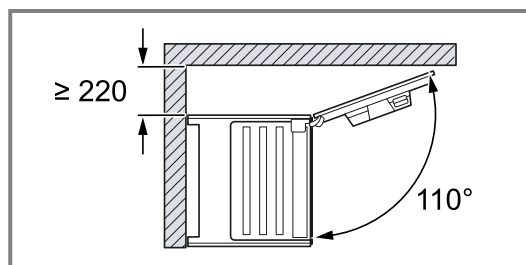

3. If the tall unit has another back panel in addition to the element back panels, this must be removed.
4. Ensure that the clearance between the appliance and the wall is 35 mm.

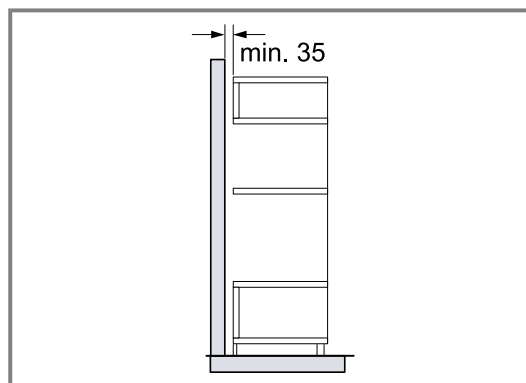

5. When installing 2 appliances on top of each other, observe the clearances.

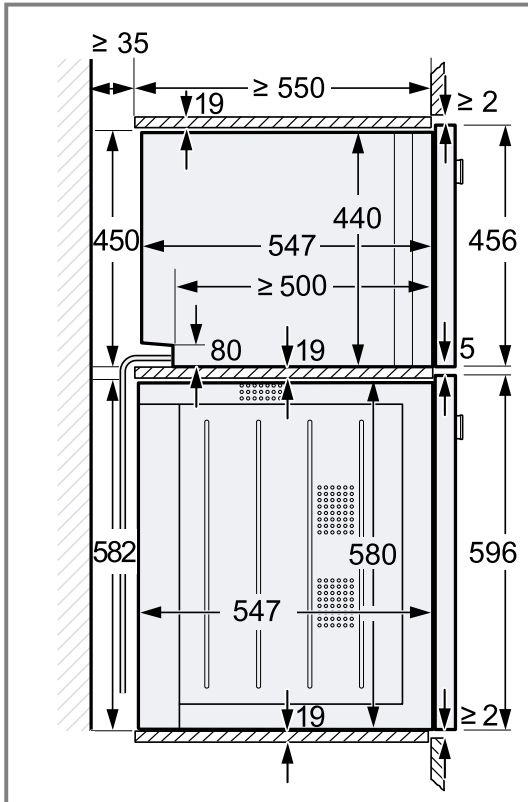

6. If there is no intermediate floor above the appliance, secure the appliance against tipping in the built-in niche.
- ▶ Secure two brackets from the GA601010 installation accessories to both sides of the built-in niche.
 - ▶ Observe the installation instructions for the brackets.

7. **Note:** Ensure that you adjust all white plastic elements on the appliance: Left and right, top and bottom.

If the thickness of the side sections of the unit is 16 mm, do not remove the white plastic elements. The white plastic elements provide support when centring the appliance.

8. If the thickness of the side sections of the unit is 20 mm, remove the white plastic elements.

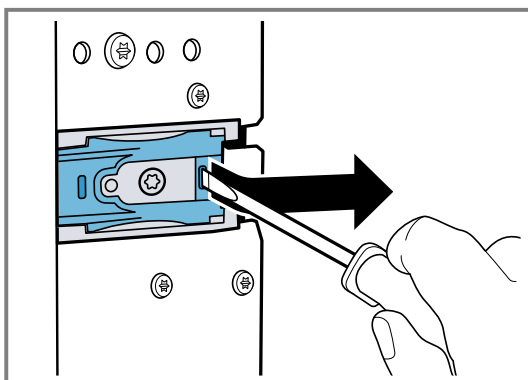

9. If the thickness of the side sections of the unit is 19 mm, remove the white plastic elements ①, turn them 180° ② and refit them ③.

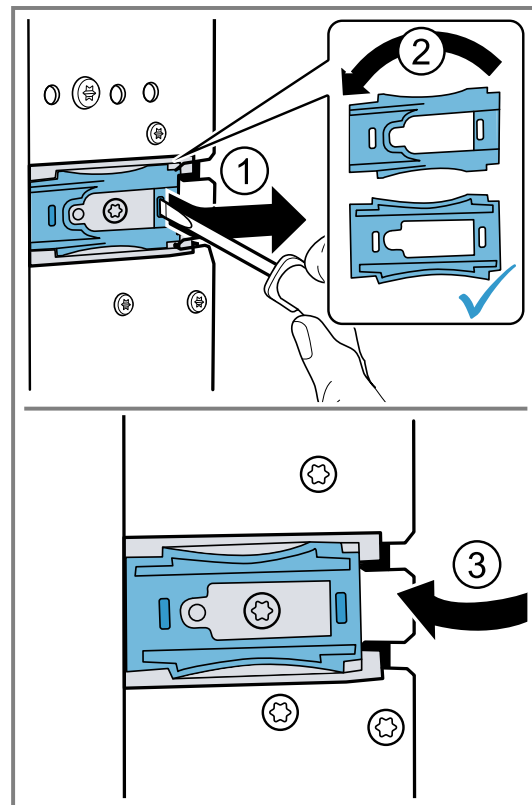

10. Push the appliance all the way into the built-in unit.
- ▶ Do not kink or trap the connection cable.

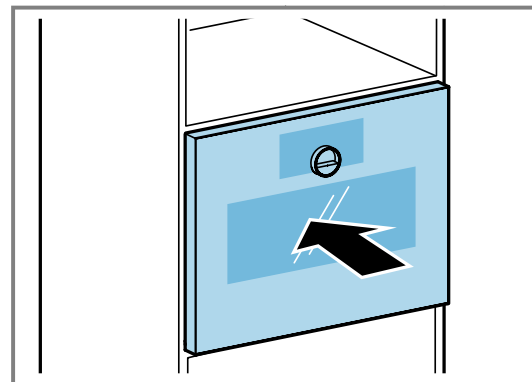

11. Centre the appliance.
There must be an air gap of at least 5 mm between the appliance and the adjacent unit fronts.
12. Use a spirit level to adjust the appliance so that it is perfectly level.

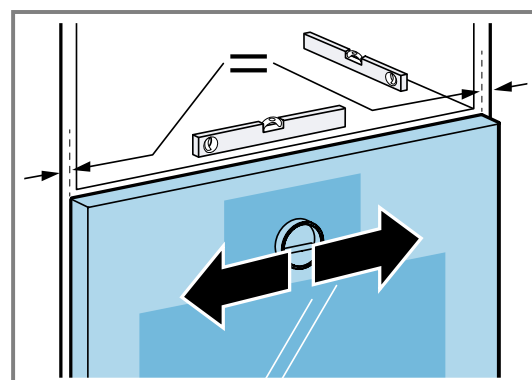

13. Open the appliance door.

14. Secure the appliance to the unit using the enclosed screws.

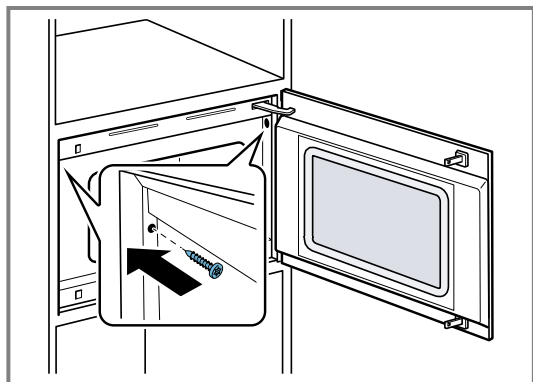

15. Remove the red plastic transport lock from the upper door catch.

16. Remove any packaging material and adhesive film from the cooking compartment and the door.

27.10 Adjustable intermediate floors with brackets

An adjustable intermediate floor with brackets (GA601010) is available for your appliance.

ATTENTION

If you install appliances on the intermediate floor with brackets that are too heavy, the intermediate floor may bend.

- ▶ Do not install the intermediate floor with brackets below an oven.
- ▶ Install the intermediate floor with brackets below a microwave oven.

If you do not install the appliance correctly on intermediate floor GA601010, the intermediate floor may bend.

- ▶ Do not position the appliance at an angle in the recess on the intermediate floor.
- ▶ Slide the appliance into the tall unit parallel to the side walls of the recess.

Note: Do not install a microwave below a fully automatic coffee machine.

Only install the intermediate floor with brackets:

- Below a combi-steam oven in the same series.
- Below a microwave in the same series.
- Below a fully automatic coffee machine that you install above an oven in the same series.
- Below a fully automatic coffee machine that you install above a combi-steam oven in the same series.

Do not install the intermediate floor with brackets:

- Below an oven.
- Between two fully automatic coffee machines that you want to install vertically stacked.
- Above a combi-steam oven in the same series.

Installing the appliance above intermediate floors with brackets

- ▶ Do not position the appliance at an angle in the recess on the intermediate floor with brackets. Slide the

appliance into the tall unit parallel to the side walls of the recess.

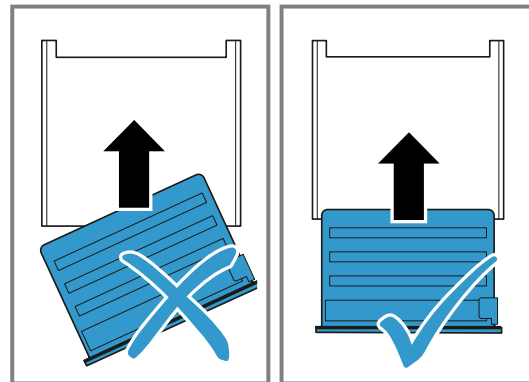

27.11 Aligning the appliance door

The device door is already aligned when the appliance is delivered. Alignment is not normally required. If required, you can adjust the appliance door's alignment at the hinge in order to achieve a precise gap. You cannot adjust the appliance door's height.

Correcting the appliance height

1. Pull the appliance out slightly from its built-in niche.
2. Loosen the locking screw.

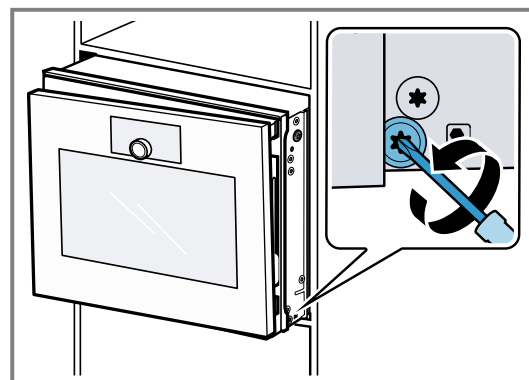

3. Open the appliance door.
4. Use the setting screw to correct the appliance height.

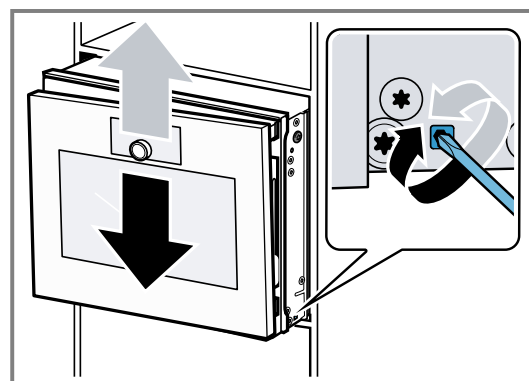

5. Tighten the locking screw.
6. Slide the appliance into the built-in niche.

Changing the door opening angle

There are two available opening angles for the appliance door.

1. Pull the appliance out slightly from its built-in recess.

- Loosen the screw on the right-hand side at the very rear of the appliance slightly.

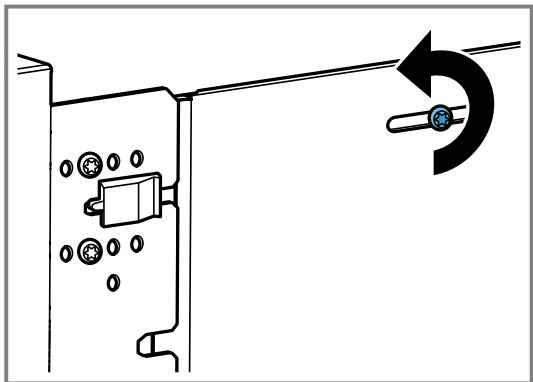

- Remove the two screws in front of the black plastic element.

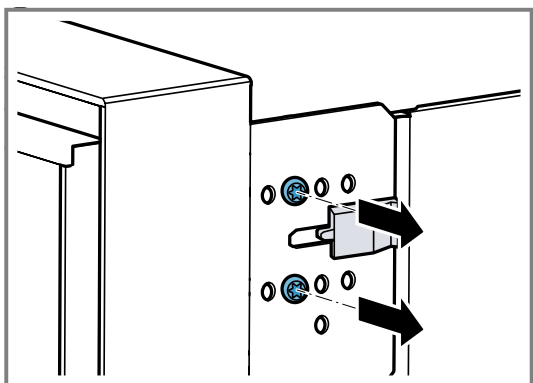

- Slide the black plastic element to the right.

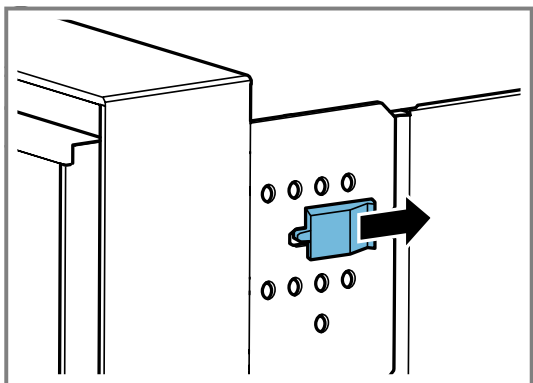

- Screw the two screws into the holes further to the right on the appliance.

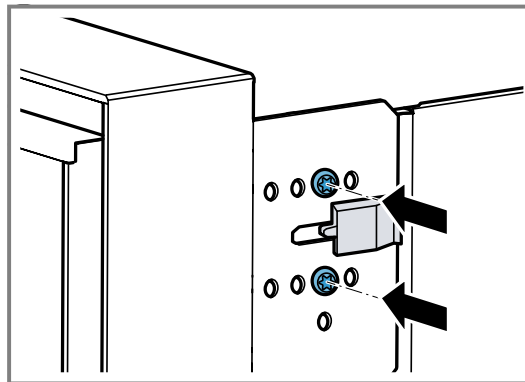

The further right you screw the screws into the appliance, the smaller the door opening angle. When the screws are positioned to the right, the opening angle of the appliance door is approx. 97°.

27.12 Starting up the appliance after installation

Requirement: The appliance has been installed and connected.

- Press  on the control ring.
- ✓ The display shows the GAGGENAU logo for approx. 30 seconds and then "Initialisation".
- Set the language.
- Follow the information in the installation assistant on the display.
 - Press → or turn the control ring.
- Select the settings for the "Installation height".
- Aligns the display horizontally or vertically depending on the installation position or the user's body size.
- Deactivate demo mode.

27.13 Combining the appliance with an oven

- Only combine suitable appliances of the same brand and series.
- Fit the microwave first, then the oven.
- When installing the appliance beside an oven, ensure that the appliance doors open in the opposite direction.

27.14 Combining the appliance with a combi-steam oven

- Only combine suitable appliances of the same brand and series.
- Fit the microwave first, then the combi-steam oven.

27.15 Combining the appliance with a fully automatic coffee machine

- Only combine suitable appliances of the same brand and series.
- Follow the installation instructions for the fully automatic coffee machine and for the intermediate floor.
- When installing above a fully automatic coffee machine, use the intermediate floor or the metal bracket.

You can obtain the intermediate floor and the metal bracket from after-sales service or the online shop.

4. When installing two appliances above each other directly beside a fully automatic coffee machine, use the intermediate floor or the metal bracket between the four appliances.

27.16 Combining the appliance with a warming drawer

ATTENTION

Sharp edges on the appliance may damage the front panel of the warming drawer.

- ▶ Do not damage the front panel of the warming drawer when sliding the appliance in.
 - ▶ Before installing another appliance, open the warming drawer, place a cloth over the front panel and close the warming drawer to protect the front panel of the warming drawer from damage.
1. Only combine suitable appliances of the same brand and series.
 2. Install the warming drawer first.
 3. Follow the installation instructions for the warming drawer.
 4. Slide the appliance, on the warming drawer, into the built-in cabinet.

27.17 Removing the appliance

1. Disconnect the appliance from the power supply.
2. Undo the fastening screws.
3. Lift the appliance slightly and pull it out completely.

The difference is Gaggenau

gaggenau.com

BSH Hausgeräte GmbH
Carl-Wery-Straße 34
81739 München, GERMANY
www.gaggenau.com

Valid within Great Britain:
Imported to Great Britain by
BSH Home Appliances Ltd.
Grand Union House
Old Wolverton Road
Wolverton, Milton Keynes
MK12 5PT
United Kingdom



9001954801 (060206) REG25
en