

SIEMENS

ET6..FEP1., ET6..FFP., ET6..FFP1C, ET6..FGP1., ET6FHP1., ET6FNP.,
ET7..FGP1.

Hob



EN User manual and installation instructions



ET6..FEP1.

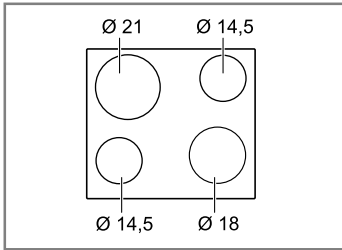

ET6FHP1.

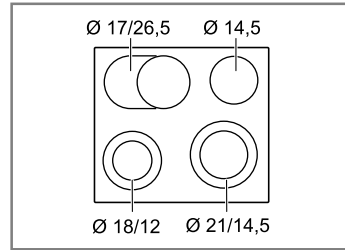

ET6..FFP..

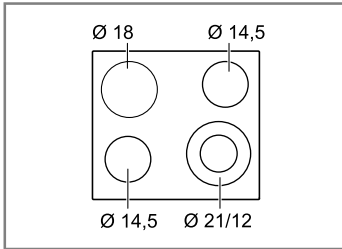

ET6FNP..

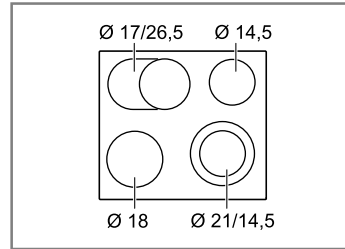

ET6..FFP1C

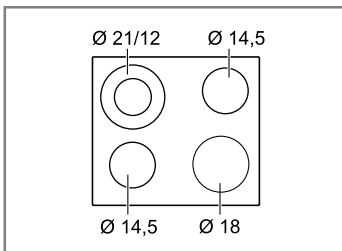

ET7..FGP1.

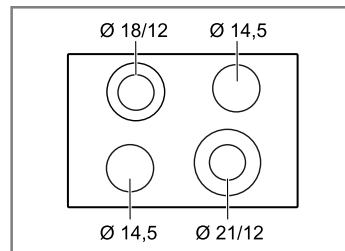

ET6..FGP1.

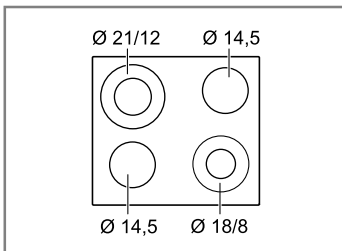

Further information and explanations are available online:



Table of contents

INFORMATION FOR USE

1	Safety	3
2	Preventing material damage	4
3	Environmental protection and saving energy	5
4	Familiarising yourself with your appliance	6
5	Basic operation	7
6	PowerBoost function	8
7	Childproof lock	9
8	Time-setting options	9
9	Automatic switch-off	10
10	Wipe protection	10
11	Energy consumption display	11
12	Basic settings	11
13	Cleaning and servicing	12
14	Troubleshooting	12
15	Disposal	13
16	Customer Service	14
17	INSTALLATION INSTRUCTIONS	14
17.1	Safe installation	14

1 Safety

Observe the following safety instructions.

1.1 General information

- Read this instruction manual carefully.
- Keep the instructions, the appliance and the product information safe for future reference or for the next owner.
- Do not connect the appliance if it has been damaged in transit.

1.2 Intended use

Only a licensed professional may connect appliances without plugs. Damage caused by incorrect connection is not covered under the warranty.

Only use this appliance:

- To prepare meals and drinks.
- Under supervision. Never leave the appliance unattended when cooking for short periods.
- in private households and in enclosed spaces in a domestic environment.
- up to an altitude of max. 2000 m above sea level.

Do not use the appliance:

- With an external timer or a separate remote control. This does not apply if operation with appliances included in EN 50615 is switched off.

1.3 Restriction on user group

This appliance may be used by children aged 8 or over and by people who have reduced physical, sensory or mental abilities or inadequate experience and/or knowledge, provided that they are supervised or have been instructed on how to use the appliance safely and have understood the resulting dangers.

Do not let children play with the appliance. Children must not perform cleaning or user maintenance unless they are at least 15 years old and are being supervised.

Keep children under the age of 8 years away from the appliance and power cable.

1.4 Safe use

WARNING – Risk of fire!

Leaving fat or oil cooking on an unattended hob can be dangerous and may lead to fires.

- ▶ Never leave hot oil or fat unattended.
- ▶ Never attempt to extinguish a fire using water; instead, switch off the appliance and then cover with a lid or a fire blanket.

The cooking surface becomes very hot.

- ▶ Never place flammable objects on the cooking surface or in its immediate vicinity.
- ▶ Never place objects on the cooking surface.

The appliance will become hot.

- ▶ Do not keep combustible objects or aerosol cans in drawers directly underneath the hob.

Hob covers can cause accidents, for example due to overheating, catching fire or materials shattering.

- ▶ Do not use hob covers.

Food may catch fire.

- ▶ The cooking process must be monitored. A short process must be monitored continuously.

⚠ WARNING – Risk of burns!

The appliance and its parts that can be touched become hot during use, particularly the hob surround, if fitted.

- ▶ Caution should be exercised here in order to avoid touching heating elements.
- ▶ Young children under 8 years of age must be kept away from the appliance.

Hob protective grilles may cause accidents.

- ▶ Never use hob protective grilles.

The appliance becomes hot during operation.

- ▶ Allow the appliance to cool down before cleaning.

⚠ WARNING – Risk of electric shock!

Improper repairs are dangerous.

- ▶ Repairs to the appliance should only be carried out by trained specialist staff.
- ▶ Only use genuine spare parts when repairing the appliance.
- ▶ If the power cord of this appliance is damaged, it must be replaced by trained specialist staff.

If the appliance or the power cord is damaged, this is dangerous.

- ▶ Never operate a damaged appliance.
- ▶ If the surface is cracked, you must switch off the appliance in order to prevent a possible electrical shock. To do this, switch off the appliance via the fuse in the fuse box rather than at the main switch.
- ▶ Call customer services. → *Page 14*

An ingress of moisture can cause an electric shock.

- ▶ Do not use steam- or high-pressure cleaners to clean the appliance.

The insulation on cables of electrical appliances may melt if it touches hot parts of the appliance.

- ▶ Never bring electrical appliance cables into contact with hot parts of the appliance.

⚠ WARNING – Risk of injury!

Saucepans may suddenly jump due to liquid between the saucepan base and the hotplate.

- ▶ Always keep hotplates and saucepan bases dry.

⚠ WARNING – Risk of suffocation!

Children may put packaging material over their heads or wrap themselves up in it and suffocate.

- ▶ Keep packaging material away from children.
- ▶ Do not let children play with packaging material.

Children may breathe in or swallow small parts, causing them to suffocate.

- ▶ Keep small parts away from children.
- ▶ Do not let children play with small parts.

2 Preventing material damage

ATTENTION!

Rough pot and pan bases will scratch the ceramic.

- ▶ Check your cookware.

Boiling pans dry may damage cookware or the appliance.

- ▶ Never place empty pans on a heated hotplate or allow to boil dry.

Incorrectly positioned cookware can cause the appliance to overheat.

- ▶ Never place hot pots or pans on the controls or the hob surround.

Damage can occur if hard or pointed objects fall onto the hob.

- ▶ Do not let hard or pointed objects fall onto the hob. Non heat-resistant materials will melt on heated hotplates.

- ▶ Do not use oven protective foil.
- ▶ Do not use aluminium foil or plastic containers.

2.1 Overview of the most common damage

Here you can find the most common types of damage and tips on how to avoid them.

Damage	Cause	Measure
Stains	Food boiling over	Remove boiled-over food immediately with a glass scraper.
Stains	Unsuitable cleaning products	Only use cleaning products that are suitable for glass ceramic.
Scratches	Salt, sugar or sand	Do not use the hob as a work surface or storage space.

Damage	Cause	Measure
Scratches	Rough pot or pan bases	Check your cookware.
Discolouration	Unsuitable cleaning products	Only use cleaning products that are suitable for glass ceramic.
Discolouration	Pan abrasion, e.g. aluminium	Lift pots and pans to move on the hob.
Blisters	Sugar or food with a high sugar content	Remove boiled-over food immediately with a glass scraper.

3 Environmental protection and saving energy

3.1 Disposing of packaging

The packaging materials are environmentally compatible and can be recycled.

- ▶ Sort the individual components by type and dispose of them separately.

3.2 Saving energy

If you follow these instructions, your appliance will use less energy.

Select the cooking zone to match the size of your pan. Centre the cookware on the hob.

Use cookware whose base diameter is the same diameter as the hotplate.

Tip: Cookware manufacturers often give the upper diameter of the saucepan. It is often larger than the base diameter.

- Unsuitable cookware or incompletely covered cooking zones consume a lot of energy.

Cover saucepans with suitable lids.

- Cooking without a lid consumes considerably more energy.

Lift lids as infrequently as possible.

- When you lift the lid, a lot of energy escapes.

Use a glass lid.

- You can see into the pan through a glass lid without having to lift it.

Use pots and pans with flat bases.

- Uneven bases increase energy consumption.

Use cookware that is suitable for the quantity of food.

- Large items of cookware containing little food need more energy to heat up.

Cook with only a little water.

- The more water that is contained in the cookware, the more energy is required to heat it up.

Turn down to a lower power level early on.

- If you use an ongoing power level that is too high, you will waste energy.

Take advantage of the hob's residual heat. With longer cooking times switch off the hotplate 5-10 minutes before the end of cooking.

- Unused residual heat increases energy consumption.

Product Information according (EU) 66/2014 can be found on the attached appliance pass and online on the product page for your appliance.

4 Familiarising yourself with your appliance

The instruction manual is the same for various different hobs. You can find the hob dimensions in the overview of models. → Page 2

4.1 Control panel

You can use the control panel to configure all functions of your appliance and to obtain information about the operating status.

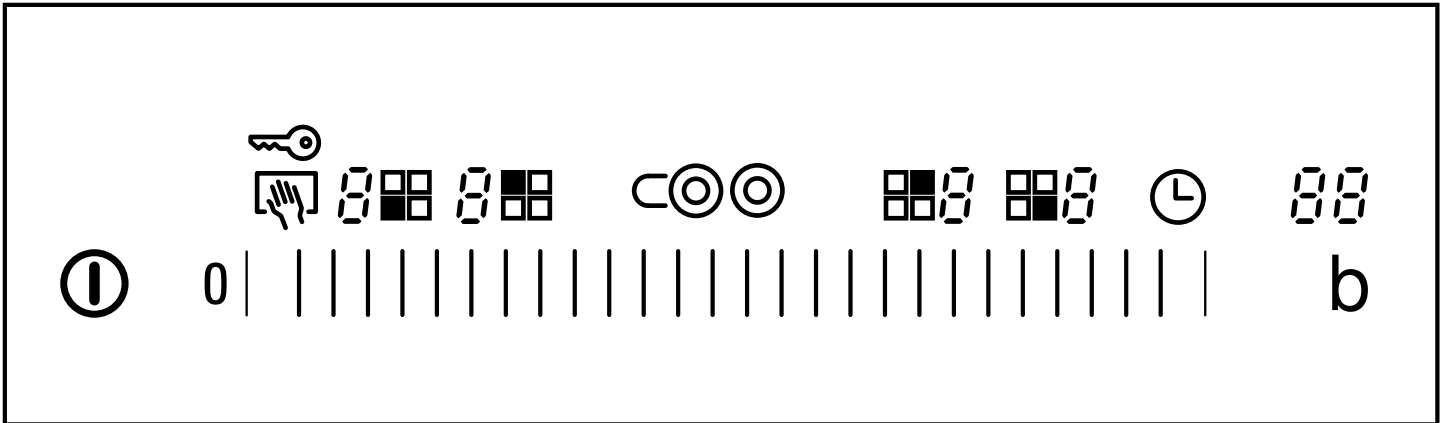

4.2 Indicators/symbols

The displays show selected values and functions.

Display	Name
1-9	Heat settings
H / h	Residual heat
b	PowerBoost function
88	Timer

4.3 Touch fields

Touch fields are touch-sensitive surfaces. To select a function, touch the relevant field.

Touch field	Name
ⓘ	Main switch
b	PowerBoost function
☐☐	Hotplate selection
🔑	Childproof lock
👉	Wipe protection
0	Settings range
☉☉ or ☉	Automatic zone control
⌚	Timer

Notes

- Always keep the control panel dry. Moisture impairs the function.
- Do not pull pans close to the displays and touch fields. The electronics may overheat.

4.4 Hotplates

You can find an overview of the different connections for the hotplates here.

If you activate the connections, the relevant displays light up.

If you switch on a hotplate, it will switch to the setting last selected.

Hot-plate	Name	Activating and deactivating
○	Single-circuit cooking zone	Select a hotplate.
☉	Dual-circuit hotplate	Select hotplate and touch ☉☉ or ☉.
☉☉	Extended cooking zone	Select hotplate and touch ☉☉.

Notes

- Dark areas in the glow pattern of the hotplate are part of the technical design. They do not affect the functionality of the hotplate.
- The hotplate regulates the temperature by switching the heat on and off. The heat may also switch on and off when at the highest setting.
- With multi-circuit hotplates, the heating of the hotplate and the activated areas may switch on or off at different times.

Reasons:

- Easily damaged components are protected against overheating.
- The appliance is protected against electrical overload.
- This achieves a better cooking result.

4.5 Residual heat indicator

The hob has a two-stage residual heat indicator for each hotplate. Do not touch the hotplate while the residual heat indicator is lit up.

Display	Meaning
H	The hotplate is so hot that you can keep small dishes warm or melt cooking chocolate.
h	The hotplate is hot.

5 Basic operation

5.1 Switching the hob on or off

The main switch is used to switch the hob on and off. If you switch the appliance back on again within 4 seconds after switching off, the hob will start up with the previously stored settings.

5.2 Switching on the hob

- ▶ Touch ①.
- ✓ The indicator lamp above ① lights up.
- ✓ The $\square\square$ displays light up.
- ✓ The hob is ready for use.

5.3 Switching off the hob

The hob will switch off automatically when all hotplates have been switched off for a while (10-60 seconds).

- ▶ Touch ①.
- ✓ The indicator lamp above ① goes out.
- ✓ The displays go out.
- ✓ All hotplates are switched off.
- ✓ The residual heat indicator remains on until the hotplates have cooled down sufficiently.

5.4 Setting the hotplates

To set a hotplate, it has to be selected. Select the required heat setting on the control panel.

Heat setting	
1	Lowest setting
9	Highest setting
.	Every heat setting has an intermediate setting, e.g. 4. .

5.5 Selecting heat settings

Requirement: The hob is switched on.

1. Select the hotplate with $\square\square$.
- ✓ \square lights up in the heat setting indicator. $_$ lights up under the heat setting indicator.

2. Select a heat setting on the control panel.

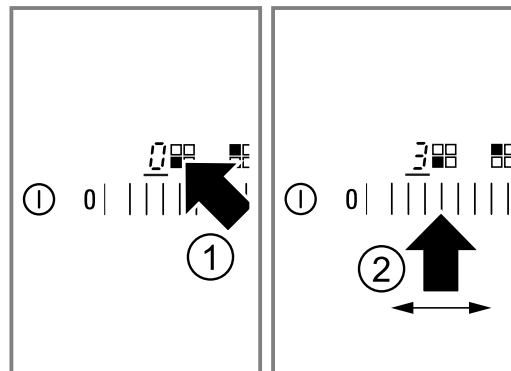

5.6 Changing heat settings

1. Select the hotplate with $\square\square$.
2. Select a heat setting on the control panel.

5.7 Switching off the hotplate

1. Select the hotplate with $\square\square$.
2. Select 0 on the control panel.
- ✓ After approx. 10 seconds the residual heat indicator appears.

Note: The hotplate last selected remains activated. You can adjust the hotplate without selecting it again.

5.8 Recommended cooking settings

You can find an overview of different foods with appropriate power levels here.

The cooking time varies depending on the type, weight, thickness and quality of the food. The ongoing power level depends on the cookware used.

Cooking tips

- To bring food to the boil, use heat setting 9.
- Stir thick liquids occasionally.
- Food that needs to be seared quickly or that initially loses a lot of liquid during frying should be fried in small portions.
- Tips for saving energy when cooking. → Page 5

Melting

Food	Ongoing cooking setting	Ongoing cooking time in minutes
Chocolate, cooking chocolate	1-1.	-
Butter, honey, gelatine	1-2	-

Heating or keeping warm

Stew, e.g. lentil stew	1-2	-
Milk ¹	1.-2.	-
Sausages in water ¹	3-4	-

¹ Prepare the dish without the lid.

Defrosting and heating

Spinach, frozen	2.-3.	10-20
Goulash, frozen	2.-3.	20-30

Poaching or simmering

Dumplings ^{1,2}	4.-5.	20-30
Fish ^{1,2}	4-5	10-15
White sauce, e.g. béchamel	1-2	3-6
Whisked sauces, e.g. sauce béarnaise or hollandaise	3-4	8-12

¹ Bring the water to the boil with the lid on.

² Continue to cook the dish without a lid.

Boiling, steaming or stewing

Rice with double the volume of water	2-3	15-30
Rice pudding	1.-2.	35-45
Potatoes boiled in their skin	4-5	25-30
Boiled potatoes	4-5	15-25
Pasta, noodles ^{1,2}	6-7	6-10
Stew, soup	3.-4.	15-60
Vegetables, fresh	2.-3.	10-20
Vegetables, frozen	3.-4.	10-20
Food in a pressure cooker	4-5	-

¹ Bring the water to the boil with the lid on.

² Continue to cook the dish without a lid.

Braising

Roulades	4-5	50-60
Pot roast	4-5	60-100
Goulash	2.-3.	50-60

Frying with little oil

Fry food without a lid.

Escalope, plain or breaded	6-7	6-10
Escalope, frozen	6-7	8-12
Chops, plain or breaded ¹	6-7	8-12
Steak, 3 cm thick	7-8	8-12
Patties, 3 cm thick ¹	4.-5.	30-40
Hamburgers, 2 cm thick ¹	6-7	10-20
Poultry breast, 2 cm thick ¹	5-6	10-20
Poultry breast, frozen ¹	5-6	10-30
Fish or fish fillet, plain	5-6	8-20
Fish or fish fillet, breaded	6-7	8-20
Fish or fish fillet, breaded and frozen, e.g. fish fingers	6-7	8-12
Scampi, prawns	7-8	4-10
Vegetables or mushrooms, fresh, sautéing	7-8	10-20
Vegetables or meat in strips cooked Asian-style	7.-8.	15-20
Stir fry, frozen	6-7	6-10
Pancakes	6-7	one by one
Omelette	3.-4.	one by one
Fried eggs	5-6	3-6

¹ Turn the dish several times.

Deep-frying

Deep-fry food in 1–2 l oil in batches, 150–200 g per batch. Cook food without a lid.

Frozen products, e.g. chips or chicken nuggets	8-9	-
Croquettes, frozen	7-8	-
Meat, e.g. chicken	6-7	-
Fish, breaded or battered	5-6	-
Vegetables or mushrooms, breaded or battered	5-6	-
Tempura		
Small pastries, e.g. doughnuts, fruit in batter	4-5	-

6 PowerBoost function

PowerBoost lets you heat up large volumes of water even faster than on heat setting 9. The PowerBoost function is only available on hotplates marked *boost*.

6.1 Switching on PowerBoost

WARNING – Risk of fire!

Oil and fat heat up quickly with the PowerBoost function. Oil and fat ignite quickly if overheated.

► When cooking, never leave the hob unattended.

Requirement: With dual-circuit hotplates the second filament circuit has to be activated for use with the PowerBoost function.

1. Select the hotplate.
2. Touch **b**.
✓ The *b* indicator lights up.

6.2 Switching off PowerBoost

If you do not switch off the PowerBoost function, it will switch off automatically after a certain period of time. The hotplate switches back to the heat setting 9.

1. Select the hotplate.

- Select any ongoing cooking setting.
 - ✓ The **b** display goes out.

6.3 Power manager



The power manager protects the home installation from overloading.

7 Childproof lock

You can use the childproof lock to prevent children from switching on the hob.

7.1 Activating the childproof lock

Requirement: The hob is switched off.

- ▶ Press and hold  for approx. 4 seconds.
- ✓ The indicator light above  lights up for 10 seconds.
- ✓ The hob is locked.

If many cooking zones are operated at a high setting, it is possible that PowerBoost will not switch on or switches itself off. **b** and **9** flash on the hotplate display. Heat setting 9 is then set automatically.

7.2 Deactivating the childproof lock

- ▶ Press and hold  for approx. 4 seconds.
- ✓ The lock is released.

7.3 Automatic childproof lock

This function automatically activates the childproof lock when you switch off the hob.

The automatic childproof lock can be activated in the basic settings. → *Page 11*

8 Time-setting options

Your appliance has different time-setting options which can be used to set a cooking time or a kitchen timer.

8.1 Cooking time

Enter a cooking time for the relevant hotplate. When the cooking time has elapsed, the hotplate switches off automatically.

You can set a cooking time of up to 99 minutes.

Setting the cooking time

Requirement: The hotplate is selected.

- Select the heat setting.
- Touch .
 - ✓ The **|→|** display for the hotplate lights up. **00** lights up on the timer display.
- Touch the required presetting on the control panel. The possible presetting from left to right is 1, 2, 3..... to 9 minutes.
- Within the next 10 seconds slide your finger along the control panel until the required cooking time is reached.

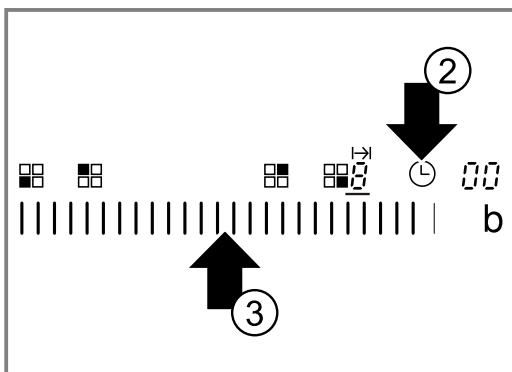

- ✓ The cooking time counts down. If you have set a cooking time for more than one hotplate, the cooking time of the hotplate selected is displayed.

- ✓ When the cooking time has elapsed, the hotplate switches off. A signal sounds and **00** flashes on the display for 10 seconds. The **|→|** display lights up brightly.

Automatically setting the cooking time

Requirement: The hotplate is selected and set. The cooking time setting is activated. → *Page 9*

- Touch the settings 1 to 5 on the control panel for longer.
 - ✓ The cooking time will automatically count down to one minute.
- Touch the settings 6 to 9 on the control panel for longer.
 - ✓ The cooking time will automatically count up to 99 minutes.

Changing or cancelling the cooking time

- Select the hotplate.
- Touch .
 - ✓ The **|→|** display lights up brightly.
- On the control panel change the cooking time or set it to **00**.

Switching off the continuous signal

You can switch the signal off manually.

- ▶ Touch any symbol.
- ✓ The displays will go out and the audible signal will stop.

Automatic timer

You can use this function to preselect a cooking time for all hotplates. Each time a hotplate is switched on, the preselected cooking time counts down. When the cooking time has elapsed, the hotplate switches off automatically.

Switch on the automatic timer in the basic settings. → *Page 11*



Tip: The automatic timer is valid for all hotplates. You can reduce or delete the cooking time for individual hotplates. → Page 9



8.2 Kitchen timer

You can set a time of up to 99 minutes after which a signal will then sound. The kitchen timer runs independently of all other settings.

Setting the kitchen timer

1. Switch on the kitchen timer.
There are 2 different ways of switching the kitchen timer on.

If a hotplate has been selected.	Touch  twice within 10 seconds.
If a hotplate has not been selected.	Touch  .

- ✓ The  indicator lights up.
2. Within the next 10 seconds set the required time on the control panel.
 - ✓ The time counts down.
 - ✓ When the time has elapsed, a signal sounds.  lights up on the timer display. The  indicator for the kitchen timer lights up brightly. It switches off after 10 seconds.

Displaying the time

- ▶ Select the kitchen timer with .
- ✓ The time is displayed for 10 seconds.

Setting the correct time

1. Select the kitchen timer with .
2. Set the required time on the control panel.



Switching off the timer signal

You can switch the signal off manually.



- ▶ Touch any touch field.
- ✓ The display goes out and the audible signal ceases.

8.3 Setting the cooking time

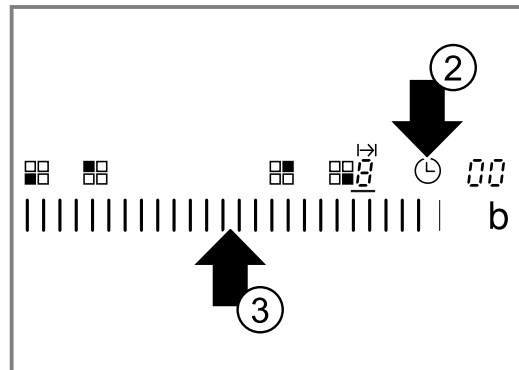

Requirement: The hotplate is selected.

1. Select the heat setting.
2. Touch .
 - ✓ The  display for the hotplate lights up.  lights up on the timer display.
3. Touch the required presetting on the control panel. The possible presetting from left to right is 1, 2, 3.... to 9 minutes.
4. Within the next 10 seconds slide your finger along the control panel until the required cooking time is reached.



- ✓ The cooking time counts down. If you have set a cooking time for more than one hotplate, the cooking time of the hotplate selected is displayed.
- ✓ When the cooking time has elapsed, the hotplate switches off. A signal sounds and  flashes on the display for 10 seconds. The  display lights up brightly.

9 Automatic switch-off

If you do not change the settings of a hotplate for a long time, automatic switch-off will be activated. When the hotplate switches off depends on the heat setting selected (1 to 10 hours). The heat to the hotplate is switched off.  and the residual heat indicator  flash alternately on the hotplate display.

9.1 Continuing cooking after automatic switch-off





1. Touch any touch field.
- ✓ The display goes out.
2. Reset.

10 Wipe protection

Wiping over the control panel while the hob is switched on may alter settings. Your hob has a wipe protection function to prevent this.

The main switch is excluded from the wipe protection function. You can switch the hob off at any time.

10.1 Activating wipe protection

- ▶ Touch  .
- ✓ A signal sounds.
- ✓ The indicator lamp above   lights up.
- ✓ The control panel is locked for 30 seconds.

11 Energy consumption display

This function indicates the total amount of energy consumed between switching the hob on and switching it off again.

Once switched off, the energy consumption is displayed in kilowatt hours, e.g. 1.08 kWh, for 10 seconds.

The accuracy of the display depends on various factors such as the voltage quality of the power supply.

The display can be activated in the basic settings.

→ Page 11

12 Basic settings

You can configure the basic settings for your appliance to meet your needs.

12.1 Overview of the basic settings

You can find an overview of the basic settings and the default factory settings here.

Display	Selection
c 1	Automatic childproof lock 0 – Switched off ¹ 1 – Switched on 2 – Manual and automatic childproof lock are switched off.
c 2	Signal tone 0 – Confirmation signal and operating error signal are switched off. The main switch signal remains switched on. 1 – Only the operating error signal is switched on. 2 – Only the confirmation signal is switched on. 3 – Confirmation signal and operating error signal are switched on. ¹
c 3	Energy consumption display Ask your electricity supplier what the mains voltage is. 0 – Consumption display is switched off. ¹ 1 – Consumption display at mains voltage of 230 V. 2 – Consumption display at mains voltage of 400 V. 3 – Consumption display at mains voltage of 220 V. 4 – Consumption display at mains voltage of 240 V.
c 5	Automatic timer 00 – Switched off. ¹ 1-99 – Cooking time after which the hotplates switch off.
c 6	Duration of the timer end signal 1 – 10 seconds. ¹ 2 – 30 seconds. 3 – 1 minute.
c 7	Activation of the heating elements 0 – Switched off 1 – Switched on 2 – The last setting before switching off the hotplate. ¹

¹ Factory setting

Display	Selection
c 9	Time for selecting hotplates 0 – Unlimited: The last hotplate selected can always be adjusted without having to select it again. ¹ 1 – You can adjust the last hotplate selected within 10 seconds after selecting it. After this time you have to select the hotplate again before adjusting it.
c 0	Resetting to the factory settings 0 – Switched off. ¹ 1 – Switched on.

¹ Factory setting

12.2 Changing basic settings

Requirement: The hob is switched off.

1. Switch on the hob.
2. Within the next 10 seconds press and hold  for approx. 4 seconds.

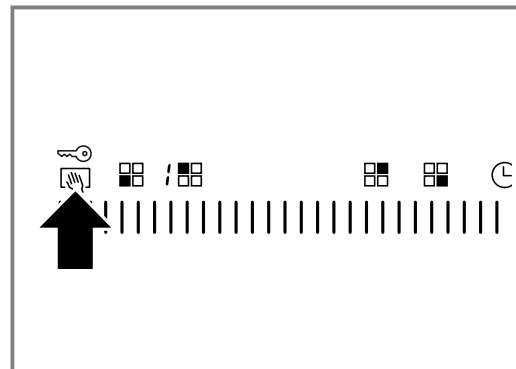

- ✓ c and 1 flash alternately on the left-hand display.
- ✓ 0 lights up on the right-hand display.
3. Repeatedly touch  until the required indicator appears on the left-hand display.

4. Set the required value on the control panel.

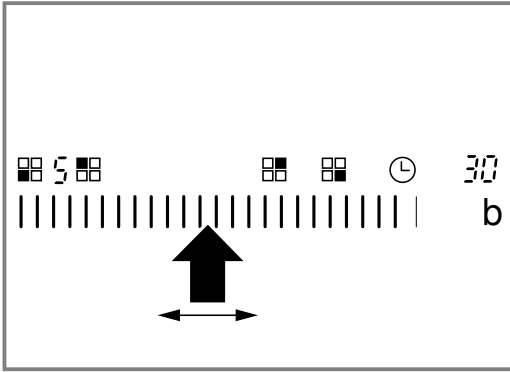

5. Press and hold  for 4 seconds.

✓ The setting is activated.

Tip: To exit the basic settings without saving, switch off the hob using . Switch the hob on again and reset.

13 Cleaning and servicing

To keep your appliance working efficiently for a long time, it is important to clean and maintain it carefully.

13.1 Cleaning products

You can obtain suitable cleaning products and glass scrapers from customer service, the online shop or a retailer.

ATTENTION!

Unsuitable cleaning products may damage the surfaces of the appliance.

- ▶ Never use unsuitable cleaning products.

Unsuitable cleaning products

- Undiluted detergent
- Detergent intended for dishwashers
- Abrasive cleaners
- Aggressive cleaning products such as oven spray or stain remover

- Abrasive sponges
- High-pressure or steam jet cleaners

13.2 Cleaning the glass ceramic

Clean the hob after every use to stop cooking residues from getting burnt on.

Note: Note the information on unsuitable cleaning products. → Page 12

Requirement: The hob has cooled down.

1. Remove heavy soiling using a glass scraper.
2. Clean the hob with a cleaning product for glass ceramic. Follow the cleaning instructions on the product packaging.

Tip: You can achieve good cleaning results using a special sponge for glass ceramic.

14 Troubleshooting

You can rectify minor faults on your appliance yourself. Read the troubleshooting information before contacting after-sales service. This will avoid unnecessary costs.

WARNING – Risk of injury!

Improper repairs are dangerous.

- ▶ Repairs to the appliance should only be carried out by trained specialist staff.
- ▶ If the appliance is defective, call Customer Service.

WARNING – Risk of electric shock!

Incorrect repairs are dangerous.

- ▶ Repairs to the appliance should only be carried out by trained specialist staff.
- ▶ Only use genuine spare parts when repairing the appliance.
- ▶ If the power cord of this appliance is damaged, it must be replaced by trained specialist staff.

WARNING – Risk of burns!

The hotplate heats up but the display does not work.

- ▶ Switch off the fuse in the fuse box.
- ▶ Call the customer service.

WARNING – Risk of fire!

The hob switches off automatically and can no longer be operated. It may switch on unintentionally at a later point.

- ▶ Switch off the fuse in the fuse box.
- ▶ Call the customer service.

14.1 Information on display panel

Fault	Cause and troubleshooting
None	There has been a power cut. <ol style="list-style-type: none"> 1. Check the household fuse for the appliance. 2. Check whether there has been a power failure by trying other electrical appliances.
All displays flash	The control panel is wet or objects are lying on it. <ul style="list-style-type: none"> ▶ Dry the control panel or remove the object.
F2	Several hotplates have been used over a prolonged period at high power settings. The hotplate has been switched off to protect the electronics. <ol style="list-style-type: none"> 1. Wait a while. 2. Touch any touch field. <ul style="list-style-type: none"> ✓ When the message no longer appears, the electronics have cooled down sufficiently. You can continue to cook.
F4	Despite being switched off by F2 , the electronics have become hot again. All hotplates have therefore been switched off. <ol style="list-style-type: none"> 1. Wait a while. 2. Touch any touch field. <ul style="list-style-type: none"> ✓ When the message no longer appears, the electronics have cooled down sufficiently. You can continue to cook.
F5 and the heat setting flash alternately. A signal sounds.	Hot pot near the control panel. There is a risk that the electronics will overheat. <ul style="list-style-type: none"> ▶ Remove the pan. ✓ The display goes out shortly afterwards.
F5 and audible signal	Hot pot near the control panel. The hotplate has been switched off to protect the electronics. <ol style="list-style-type: none"> 1. Remove the pot. 2. Wait a while. 3. Touch any touch field. <ul style="list-style-type: none"> ✓ When the message no longer appears, the electronics have cooled down sufficiently. You can continue to cook.
F8	The hotplate was on for too long and has switched off automatically. You can switch the hotplate back on again immediately.
dE and hotplates do not heat up	Demo mode is activated. <ol style="list-style-type: none"> 1. Disconnect the appliance from the power supply for 30 seconds by briefly switching off the circuit breaker in the fuse box. 2. Touch any touch field within the next three minutes.
A message with "E" appears on the display, e.g. E0111.	The electronics have detected a fault. <ol style="list-style-type: none"> 1. Switch the appliance off and on again. 2. If the message appears again, call the after-sales service. Please specify the exact error message when calling. → "Customer Service", Page 14

15 Disposal

15.1 Disposing of old appliance

Valuable raw materials can be reused by recycling.

- ▶ Dispose of the appliance in an environmentally friendly manner. Information about current disposal methods are available from your specialist dealer or local authority.



This appliance is labelled in accordance with European Directive 2012/19/EU concerning used electrical and electronic appliances (waste electrical and electronic equipment - WEEE). The guideline determines the framework for the return and recycling of used appliances as applicable throughout the EU.

16 Customer Service

Function-relevant genuine spare parts according to the corresponding Ecodesign Order can be obtained from Customer Service for a period of at least 10 years from the date on which your appliance was placed on the market within the European Economic Area.

Note: Under the terms of the manufacturer's warranty the use of Customer Service is free of charge.

Detailed information on the warranty period and terms of warranty in your country is available from our after-sales service, your retailer or on our website.

If you contact Customer Service, you will require the product number (E-Nr.) and the production number (FD) of your appliance.

The contact details for Customer Service can be found in the enclosed Customer Service directory or on our website.

16.1 Product number (E-Nr.) and production number (FD)

You can find the product number (E-Nr.) and the production number (FD) on the appliance's rating plate.

The rating plate can be found:

- on the appliance certificate.
- on the lower section of the hob.

Make a note of your appliance's details and the Customer Service telephone number to find them again quickly.

17 Installation instructions

Observe this information when installing the appliance.



17.1 Safe installation

Follow these safety instructions when installing the appliance.

- Electrical connection must only be carried out by licensed specialist staff. Incorrect connection will invalidate the warranty.
- The safe operation of this appliance can only be guaranteed if it has been installed to a professional standard in accordance with these installation instructions. The installer shall be liable for any damage resulting from incorrect installation.

17.4 Preparing the units

The worktop must be level, horizontal and stable.

- The fitted units, including wall finishing strips, must be heat-resistant to at least 90 °C.
- Niche cladding within 50 mm of the back wall must not be combustible (e.g. tiles, stone).

17.2 Built-under

Do not install refrigerators, dishwashers, non-ventilated ovens or washing machines underneath the appliance.

- If you fit an oven below the appliance, the worktop must be at least 20 mm thick, in certain cases even thicker. Observe the information in the oven installation instructions.
- Make sure that projecting parts such as the mains housing or the mains cable do not collide, e.g. with a drawer.

17.3 Intermediate floor

If the underside of the hob can be touched, an intermediate floor must be fitted.

- Ask your specialist retailer for an intermediate floor as an accessory.
- If you use your own intermediate floor, the minimum distance to the mains connection of the appliance must be 10 mm.

- Seal the cut surfaces to make them heat-resistant. This prevents the worktop from swelling as a result of moisture.

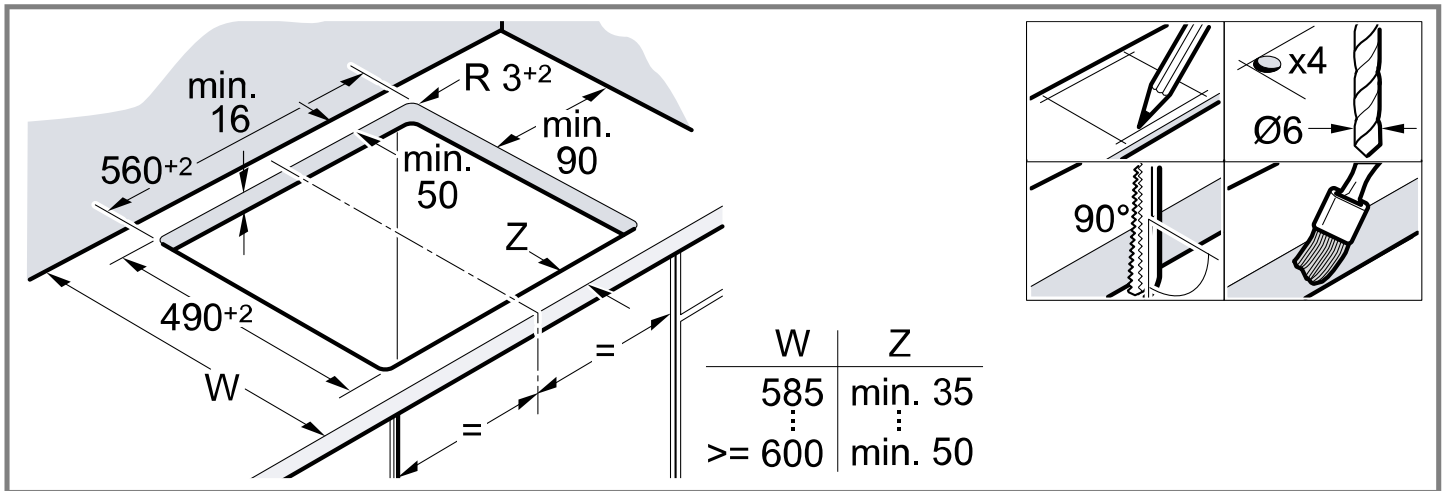

17.5 Electrical connection

To protect the device, only remove the device from the styrofoam shells when you press the device into the cut-out. Never place the device upright on one side of the device.

- Check the household wiring before connecting the appliance.
- The appliance fulfils the requirements of protection class I and must only be operated in conjunction with an earth conductor.
- In the permanent electrical installation, a partition must be provided in the phases in accordance with the installation regulations.
- If **U400** appears on the appliance's display, it has not been connected correctly. Disconnect the appliance from the mains and check the connection.

Connecting with a 3-wire cable

Ensure that there is sufficient fuse protection for the household wiring.

Observe the colour coding of the power cable.

- The protective conductor is green/yellow (⊕).
- The neutral conductor is blue.
- The phase (external conductor) is brown.
- If required, the cable must be replaced with a multi-phase power cable. When replacing the cable, observe the following paragraph.

Connecting without a pre-installed cable

Only connect the hob in accordance with the connection diagram.

- If required, install the enclosed copper bridges.
- The power cable must correspond to type H05 VV-F or a higher rating.
- Use the current load to determine which wire cross-section you require. A cross-section of < 1.5 mm² is not permitted.

Connecting with a pre-installed 5-wire power cable

The power cable must only be replaced by trained customer service personnel.

17.6 Installing the hob

Do not trap the power cable and do not route it over sharp edges.

- If the oven is a built-under type, route the cable along the rear corners of the oven to the mains socket.

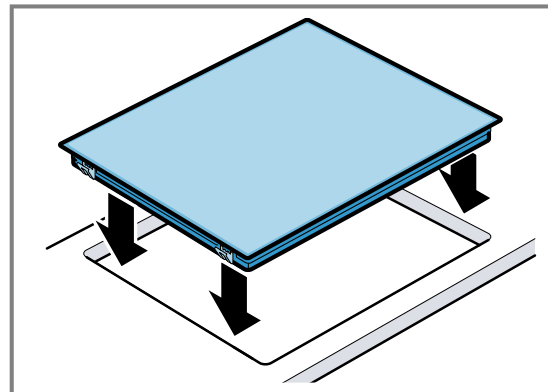

- The hob can also be installed in an existing cut-out that has a depth of 500 mm.
- It must protrude by the same distance at the front and the rear.

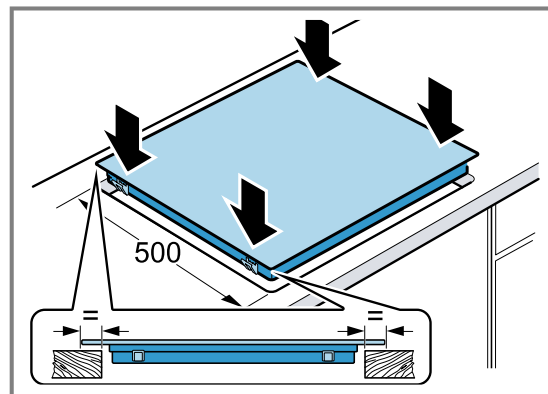

17.7 Removing the hob

1. Disconnect the appliance from the power supply.
2. Push out the hob from below.

EN Manufactured by BSH Hausgeräte GmbH under the trademark licence of Siemens AG

Valid within Great Britain:
Imported to Great Britain by
BSH Home Appliances Ltd.
Grand Union House
Old Wolverton Road
Wolverton, Milton Keynes
MK12 5PT
United Kingdom

BSH Hausgeräte GmbH
Carl-Wery-Straße 34
81739 München, GERMANY
siemens-home.bsh-group.com



9001903881

(031116)

en