

9001902293 (040228) 642A\_SK\_86.5\_Tuerassi



**de** Montageanleitung  
**sv** Installationsanvisningar  
**no** Installasjonsveiledning

**fi** Asennusohjeet  
**da** Installationsvejledning



**de** über den Kundendienst erhältlich  
**sv** går att beställa via service  
**no** fås hos kundeservice

**fi** saatavissa huoltopalvelusta  
**da** Fås hos kundeservice

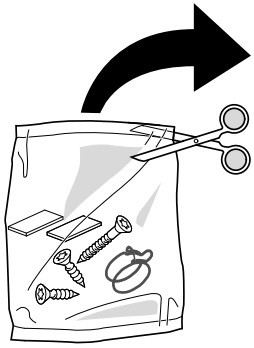

Ø4X36 Ø4X30

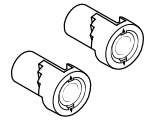
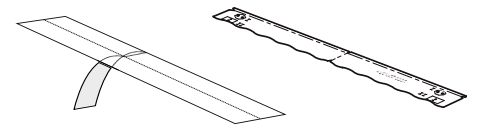
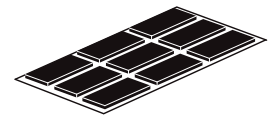
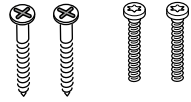

Ø4X15

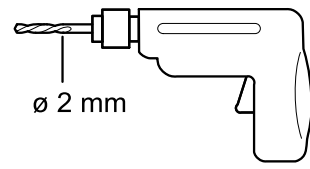
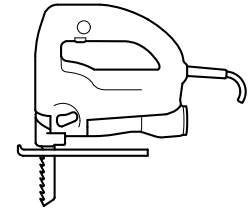
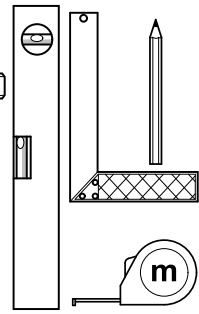
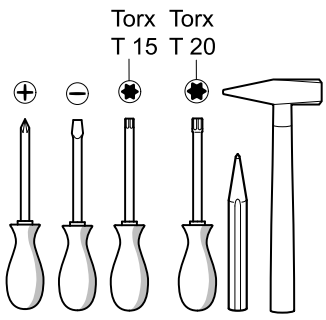
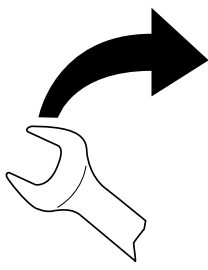
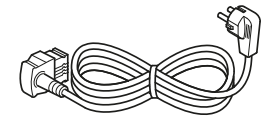
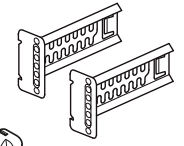
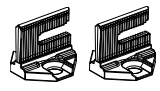
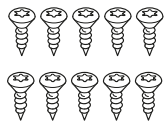

SW13

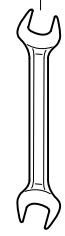

SW10

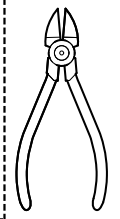
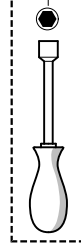

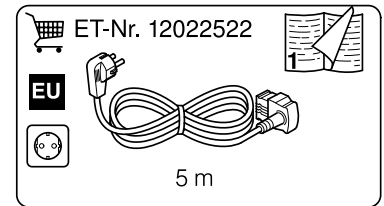
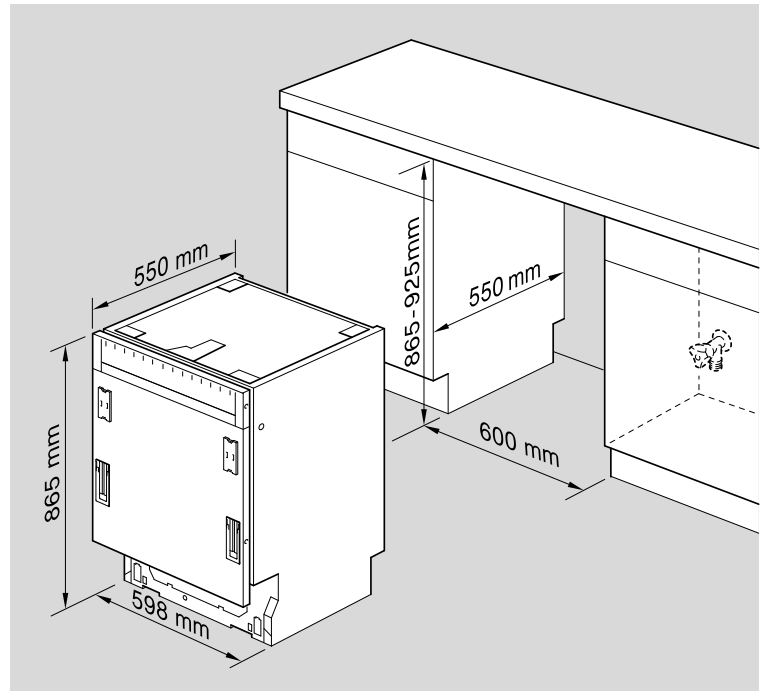
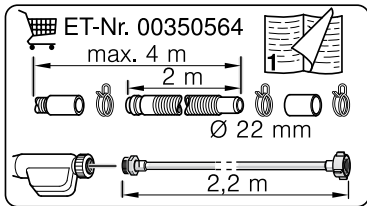
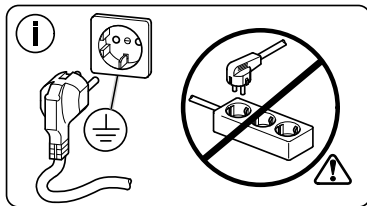
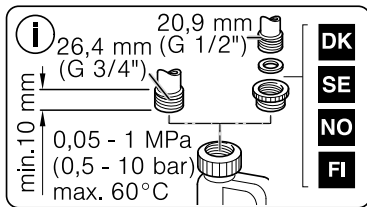
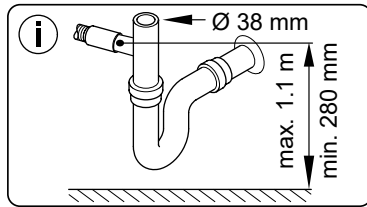

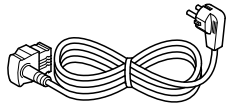

ET-Nr. 12022522

EU 5 m

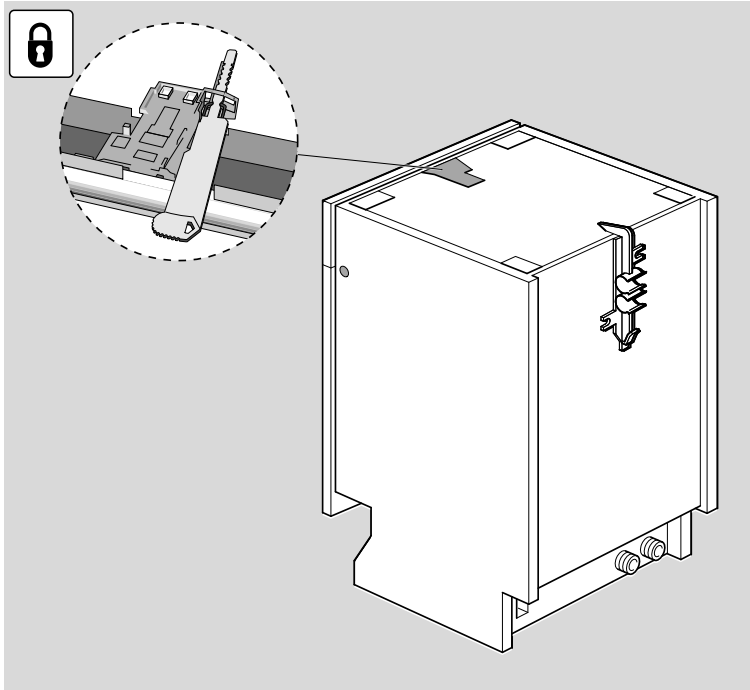
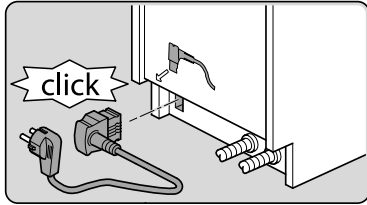
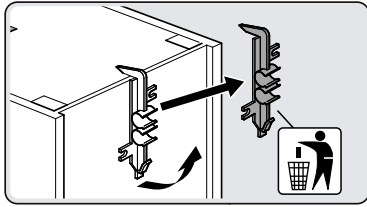

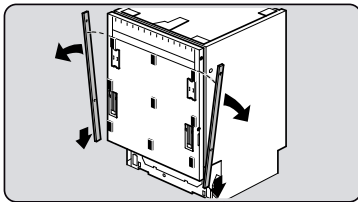
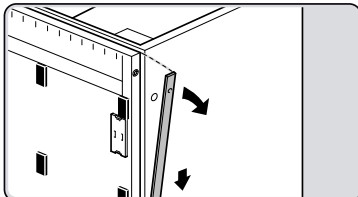
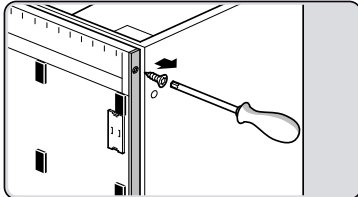
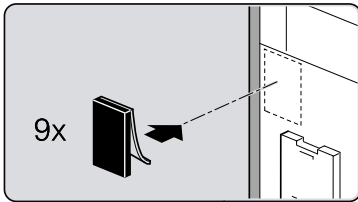
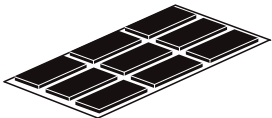

Torx  
T 15

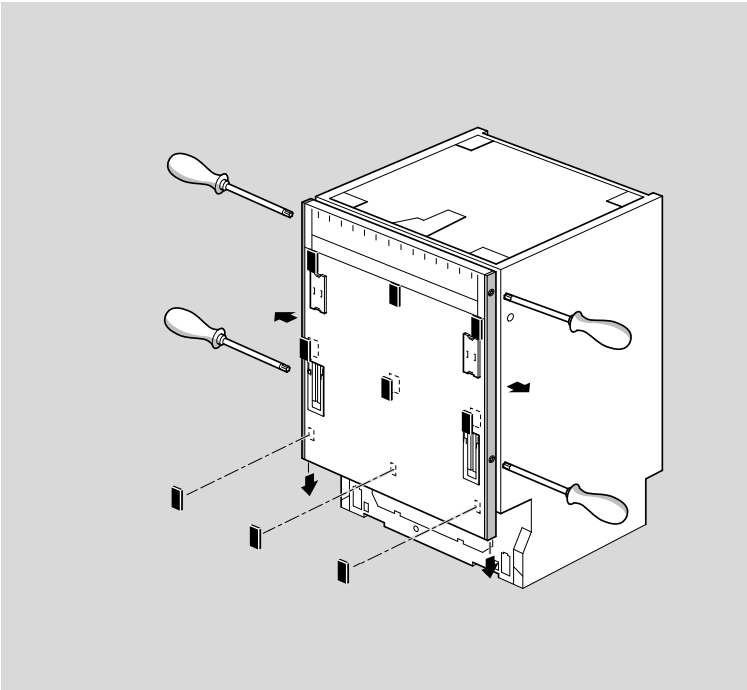

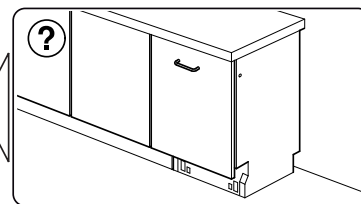
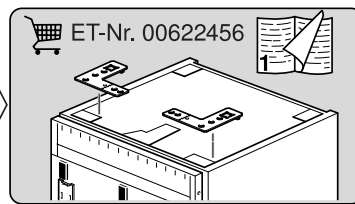
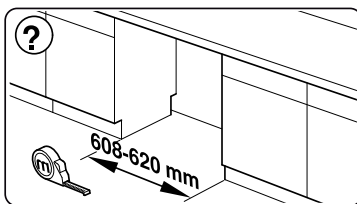
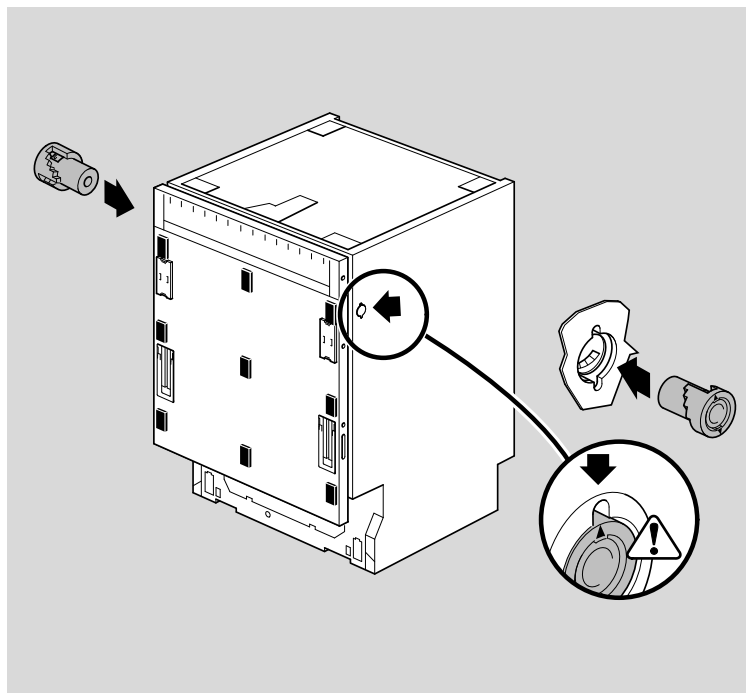
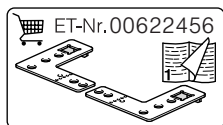
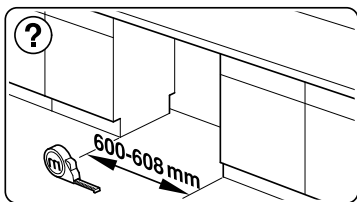
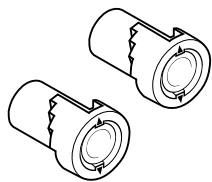

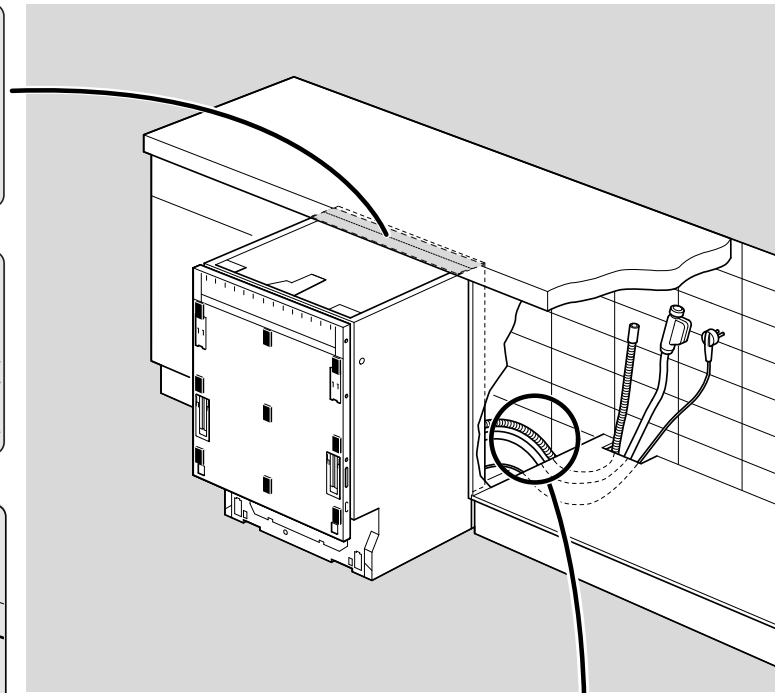
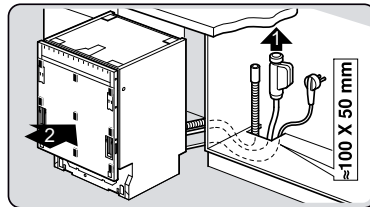
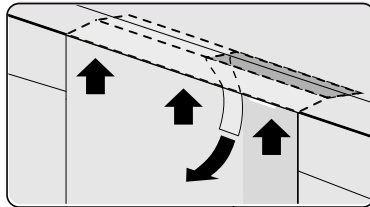
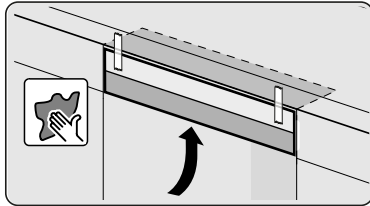
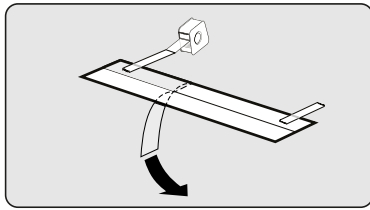
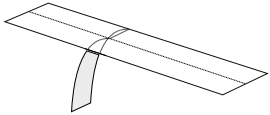

nicht einklemmen  
do not pinch  
ne pas coincer  
No doblar

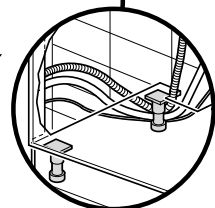

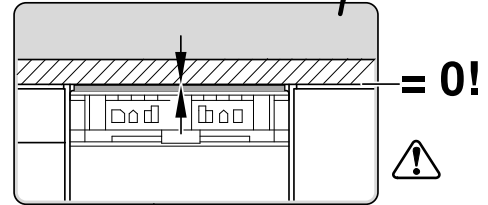
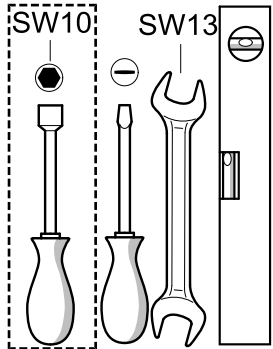
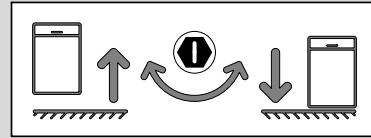
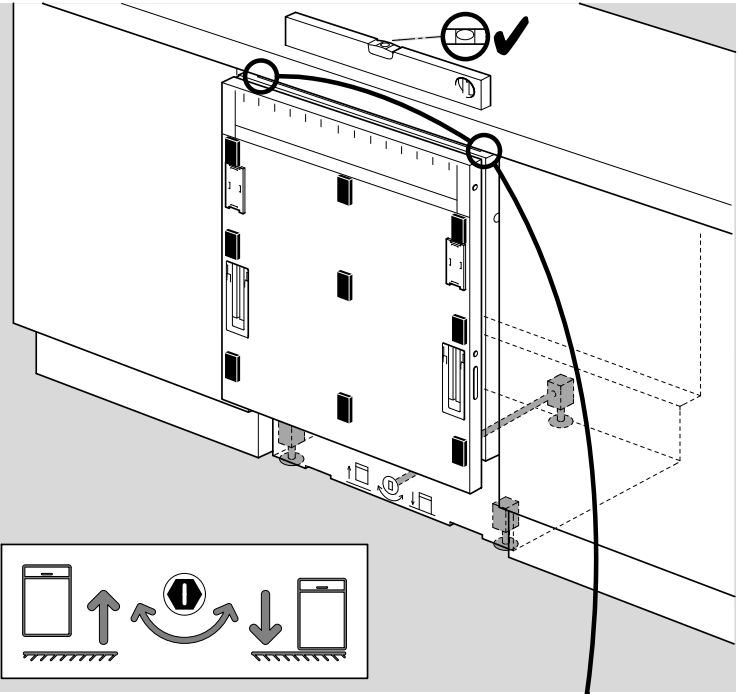
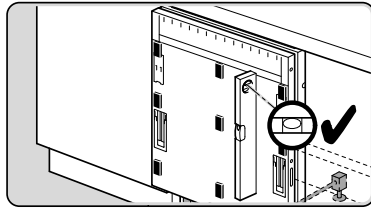
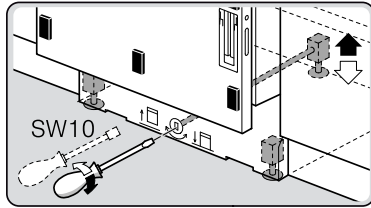
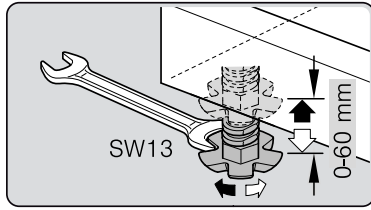



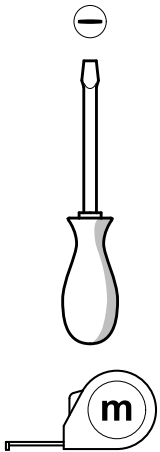
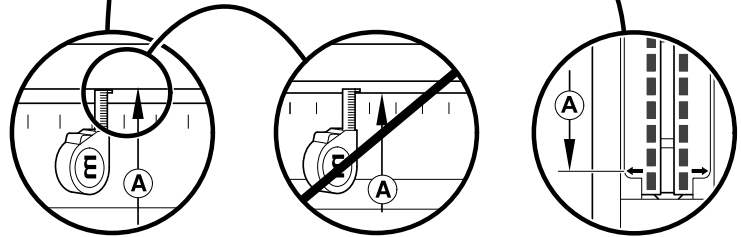
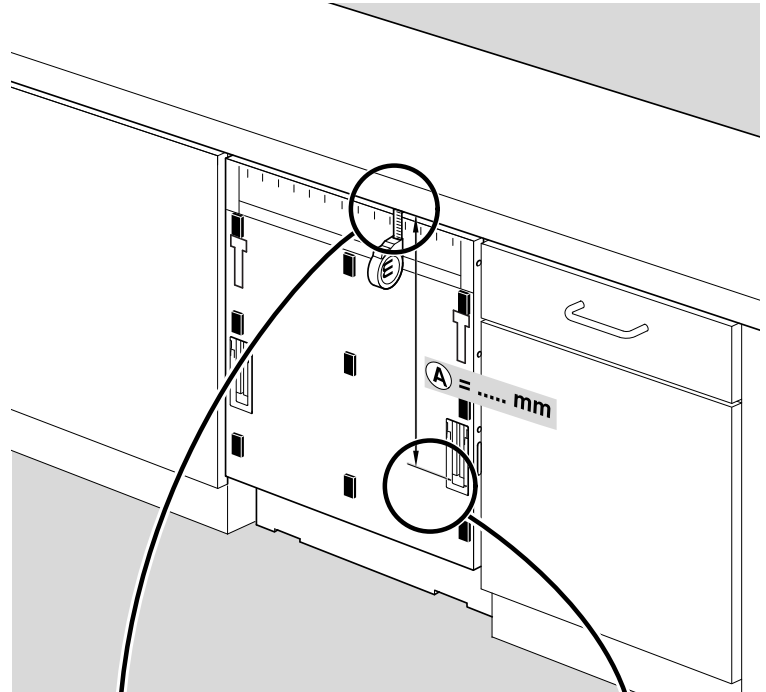
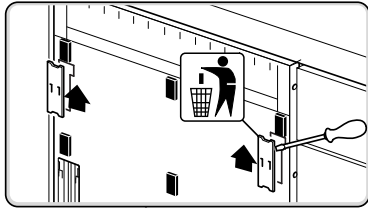

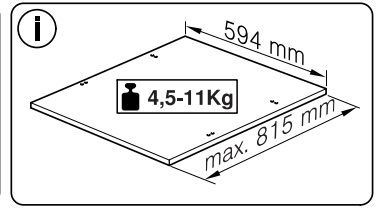
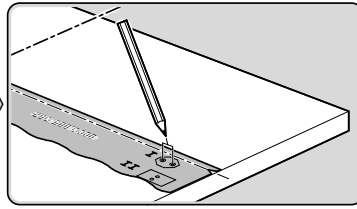
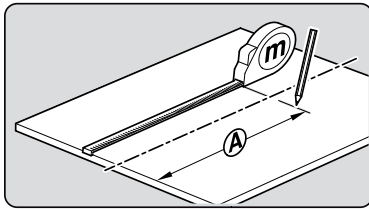
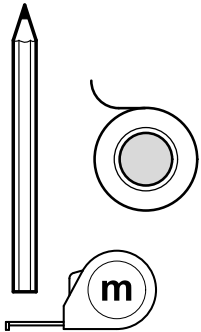
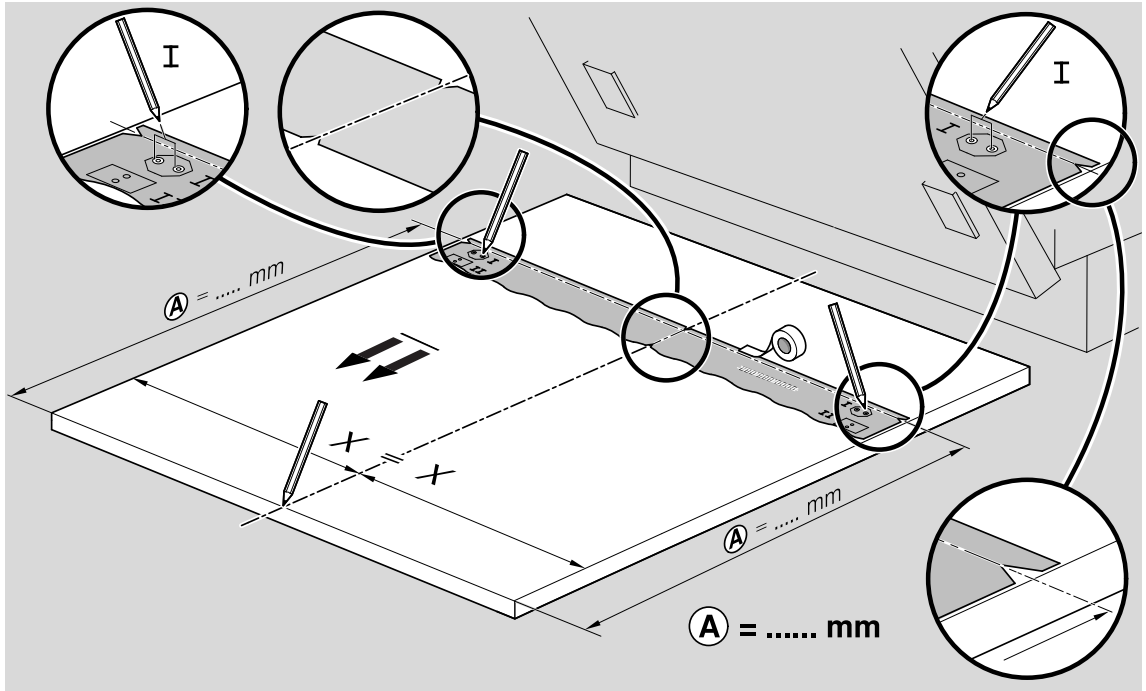
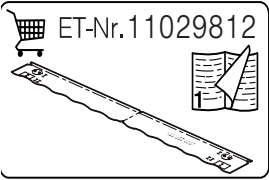
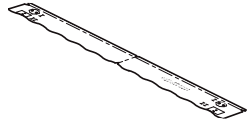

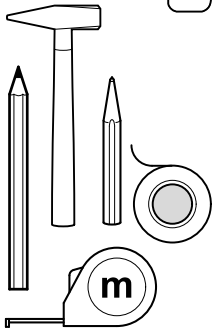
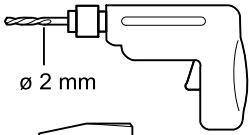
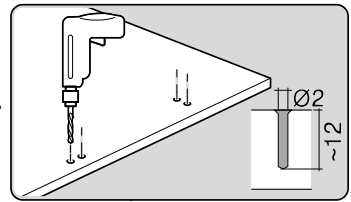
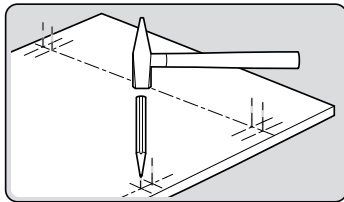
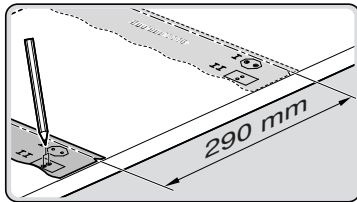
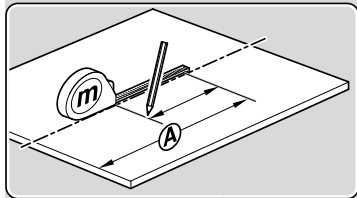
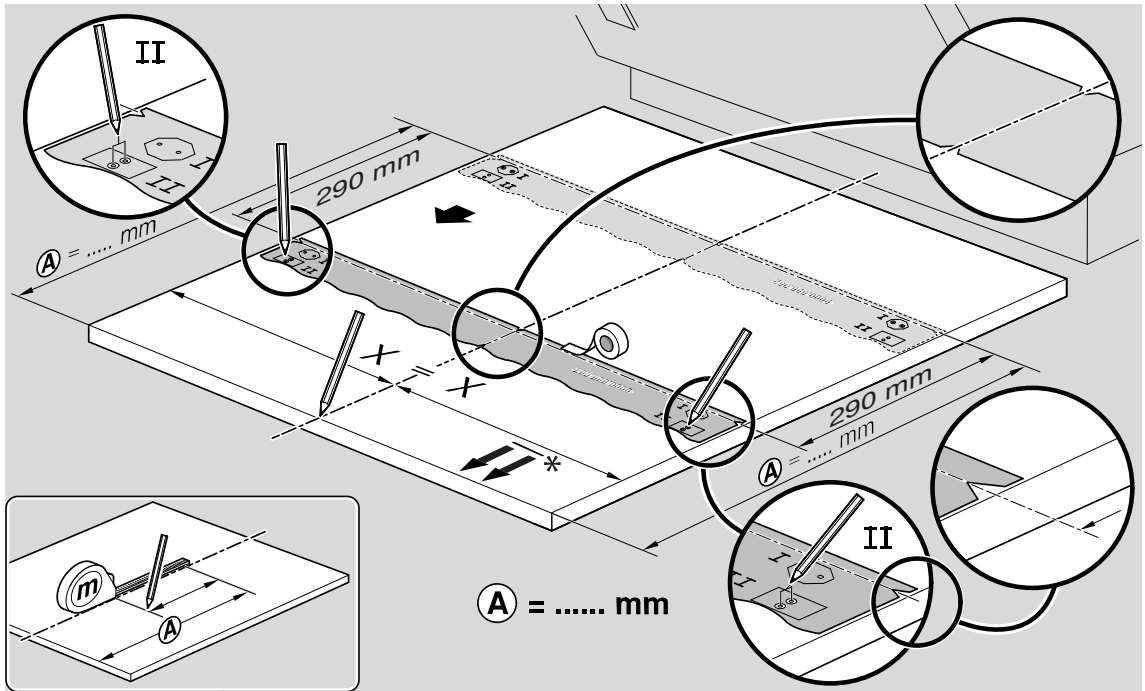
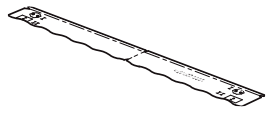

Ø4X15

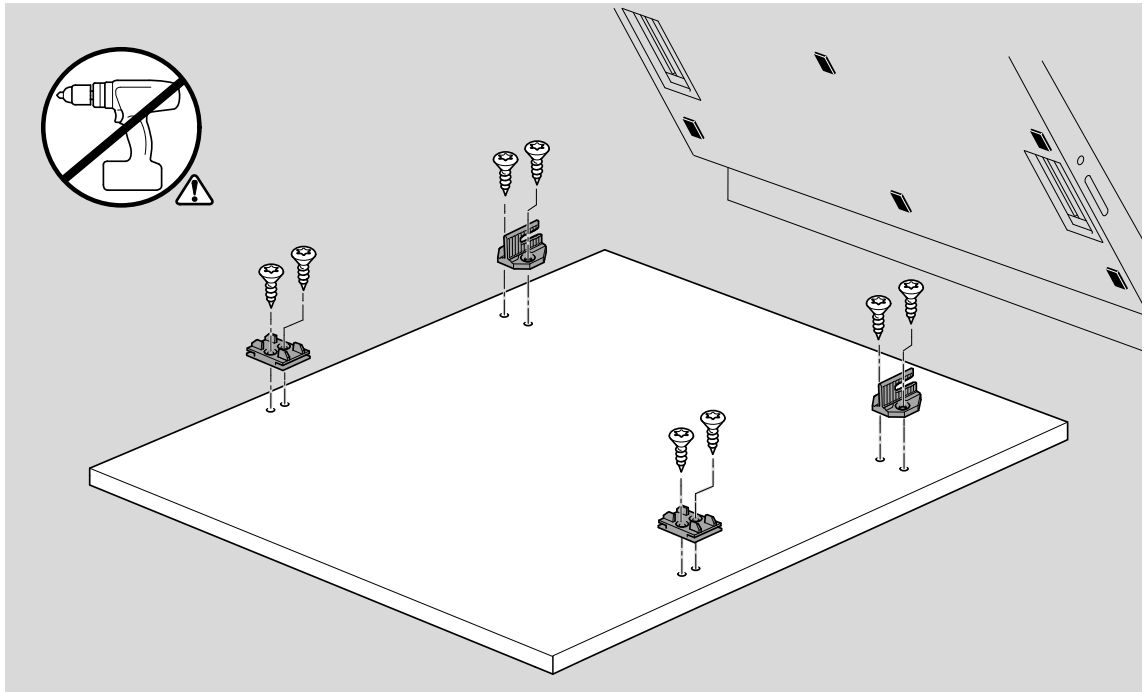
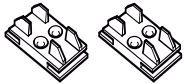
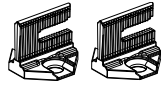

Torx  
T 20

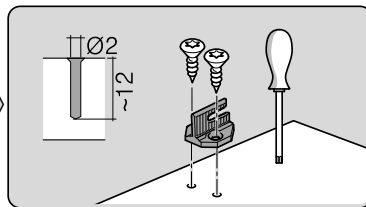
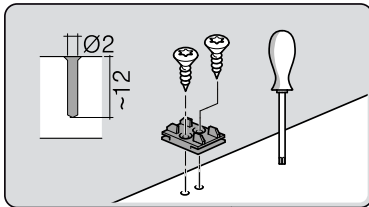
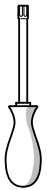

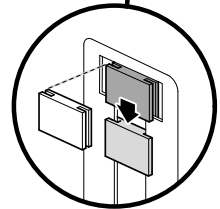
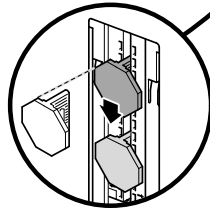
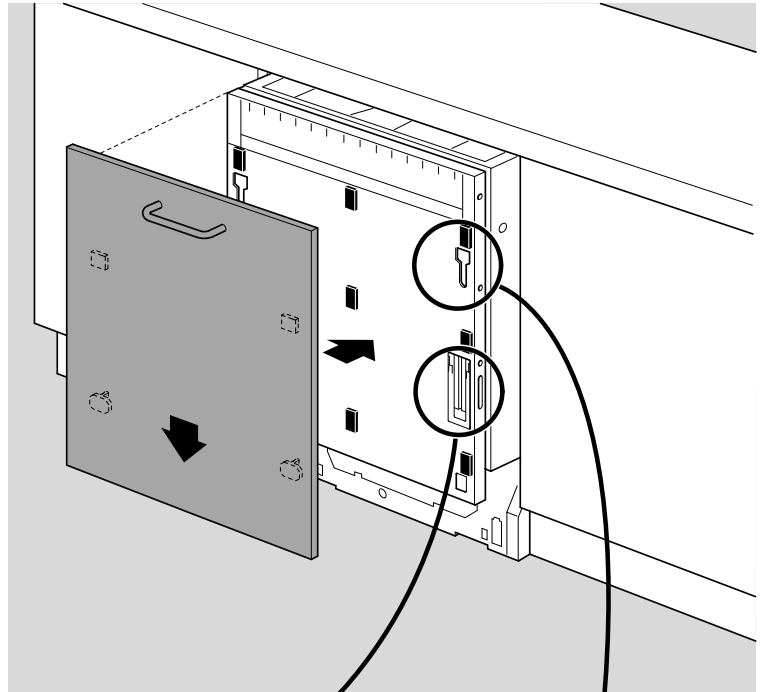
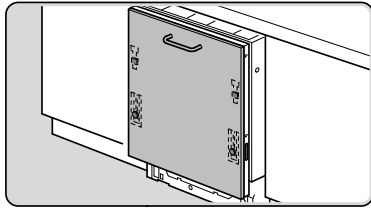
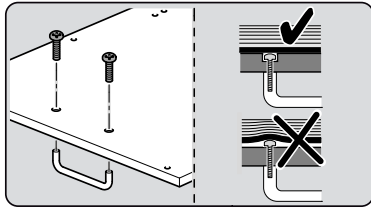

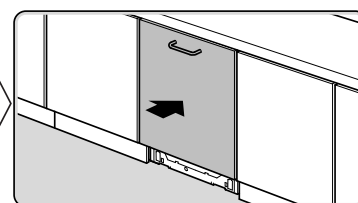
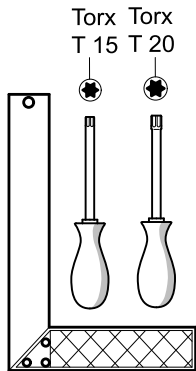
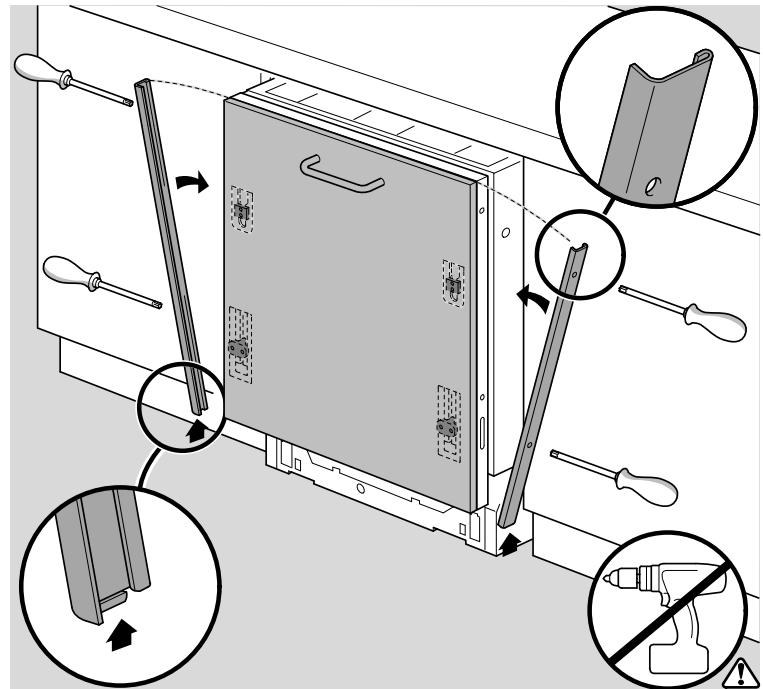
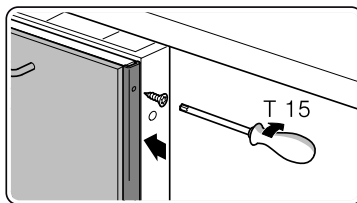
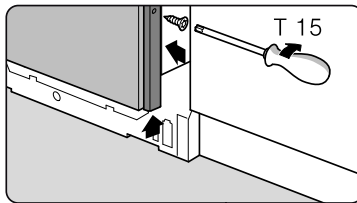
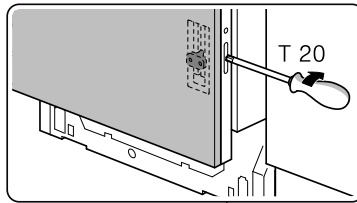
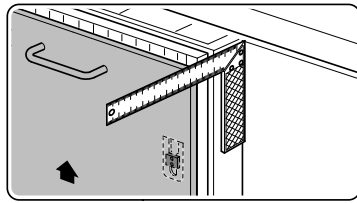

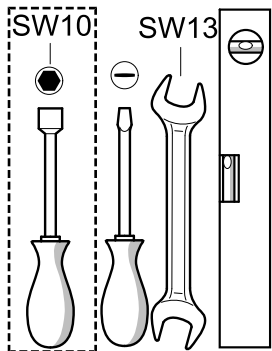
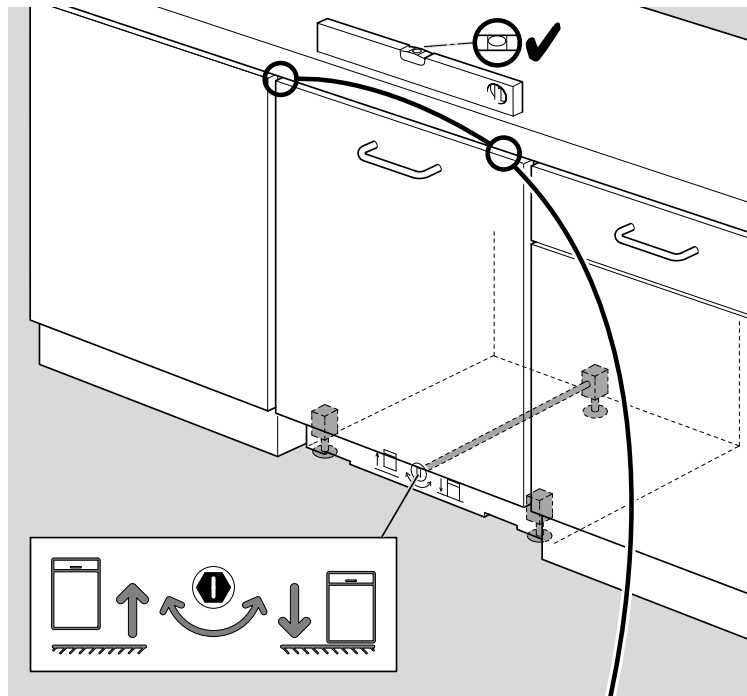
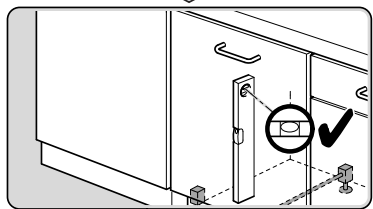
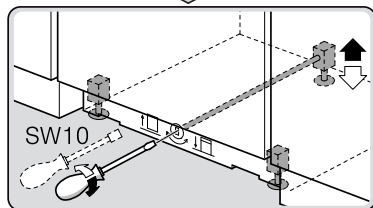
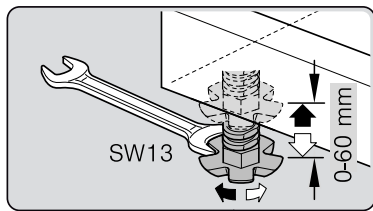

**verspannen**  
**brace**  
**calar verticalement**  
**Enrasar**

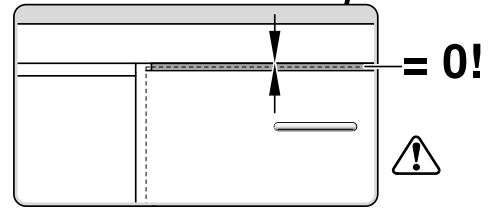

Ø4X30



Torx  
T 20

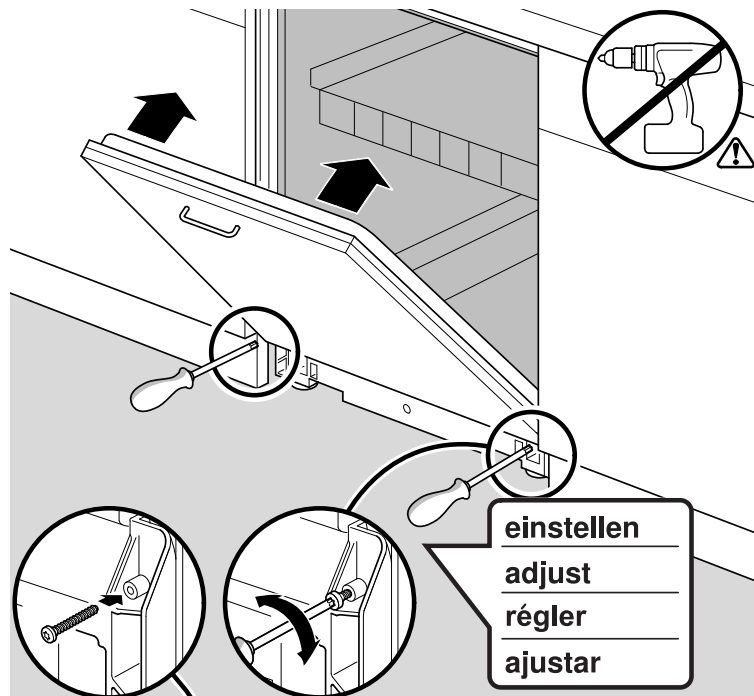
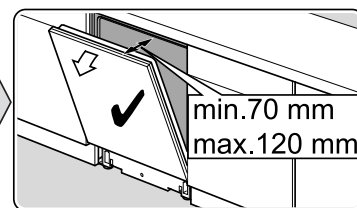
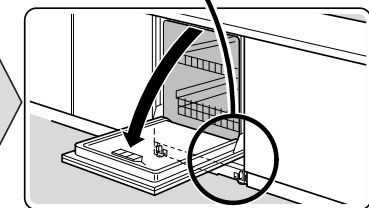
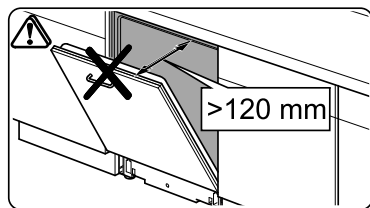
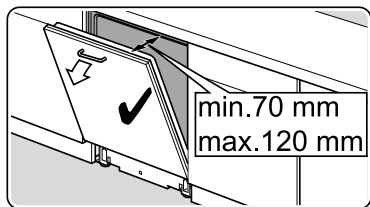



Ø4X36

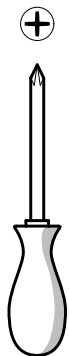
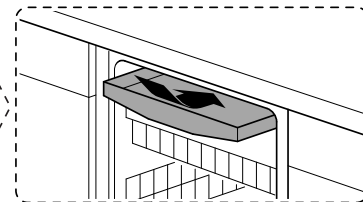
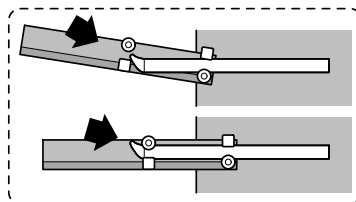
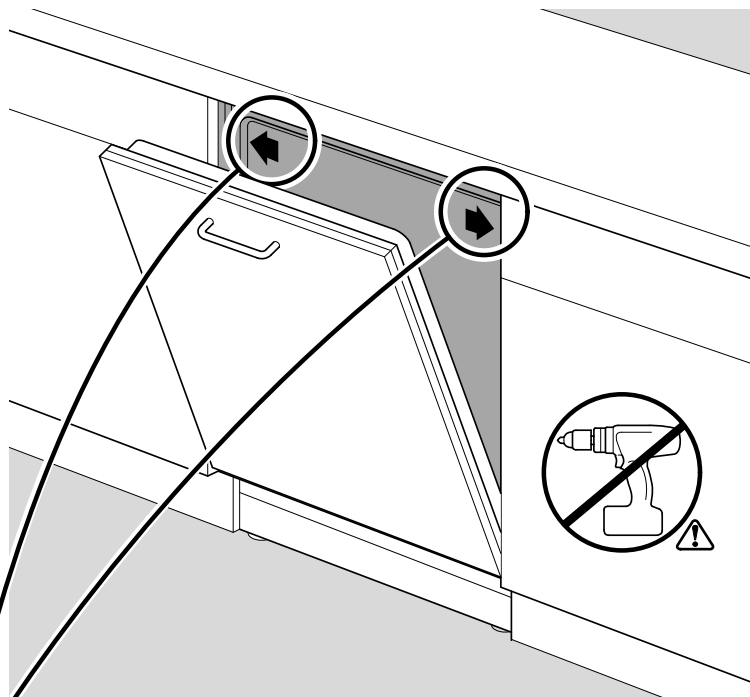
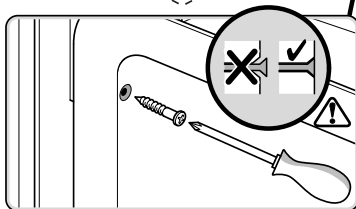
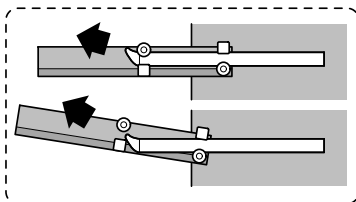
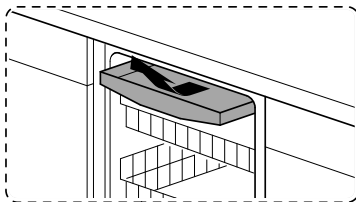
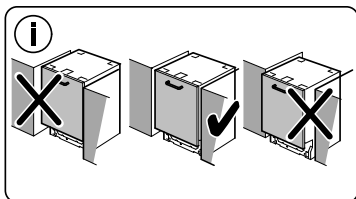
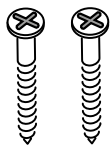

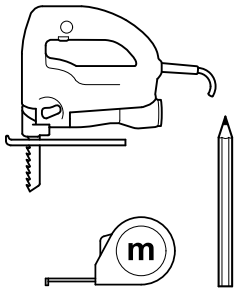
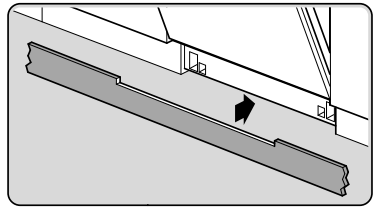
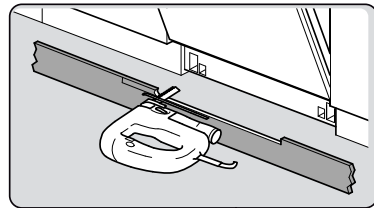
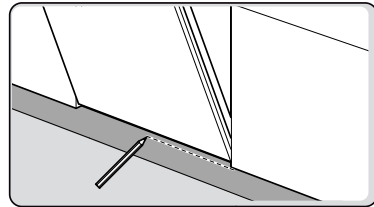
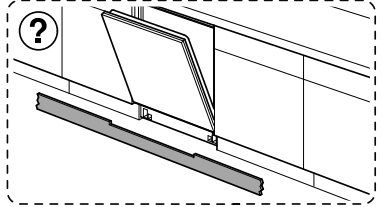
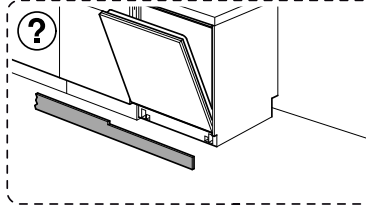
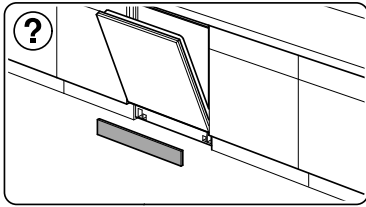

Ø4X15

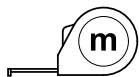
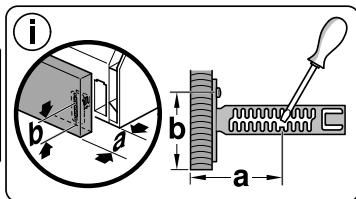
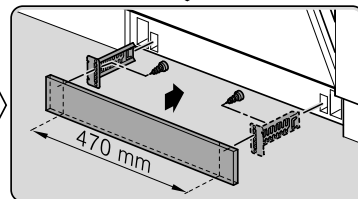
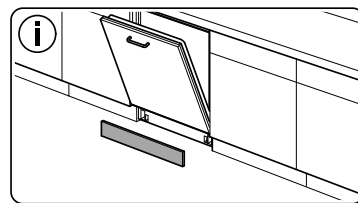
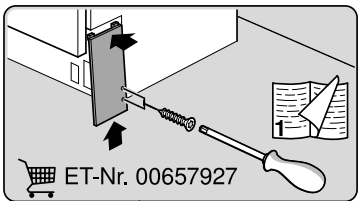
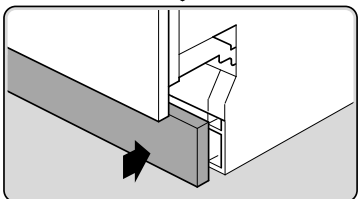
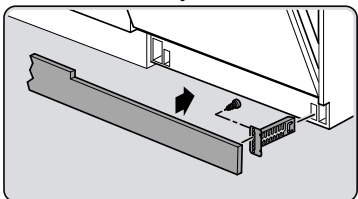
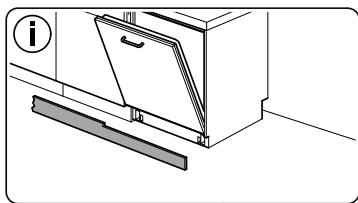
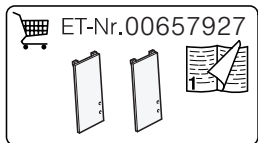
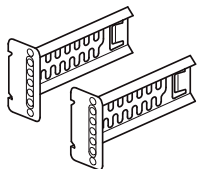

Torx  
T 20

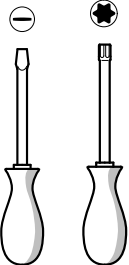

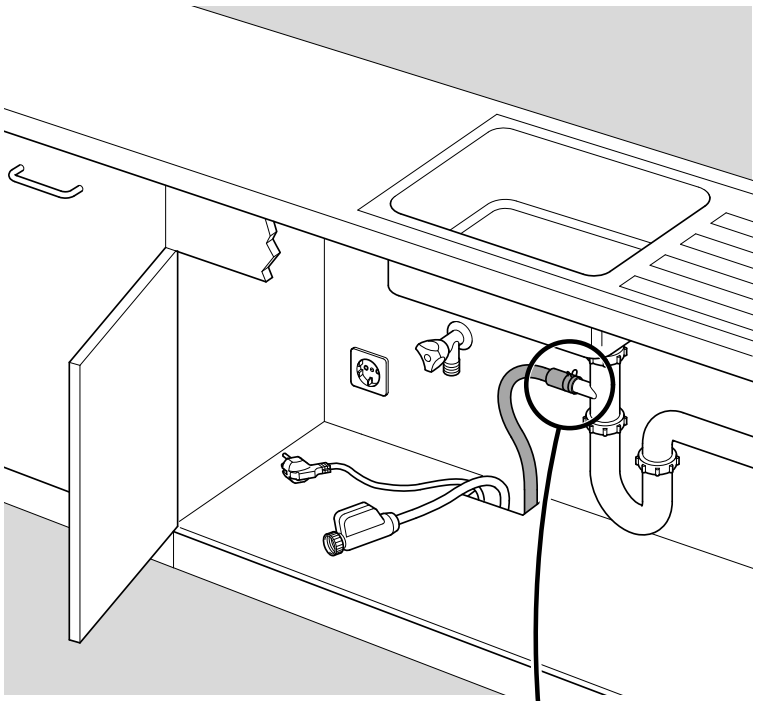
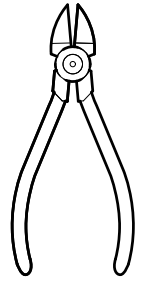
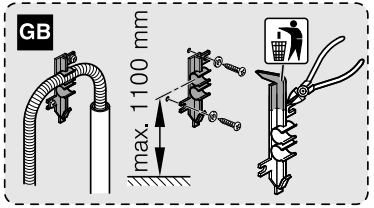
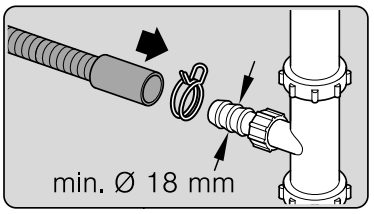
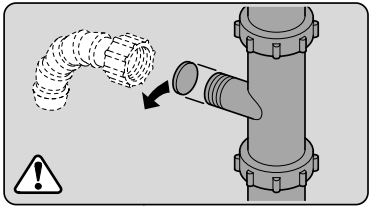
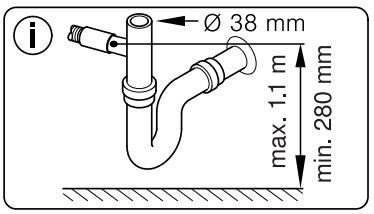

Dichtheit prüfen  
Check for leaks  
Verifiez l'étanchéité  
Verificar la estanqueidad

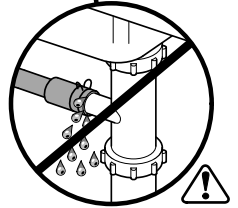

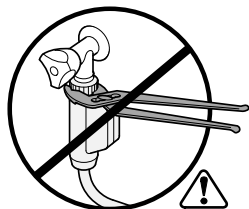
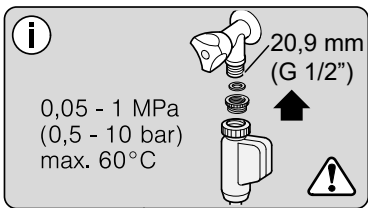
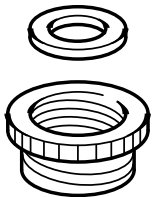

**max. 10 Nm**

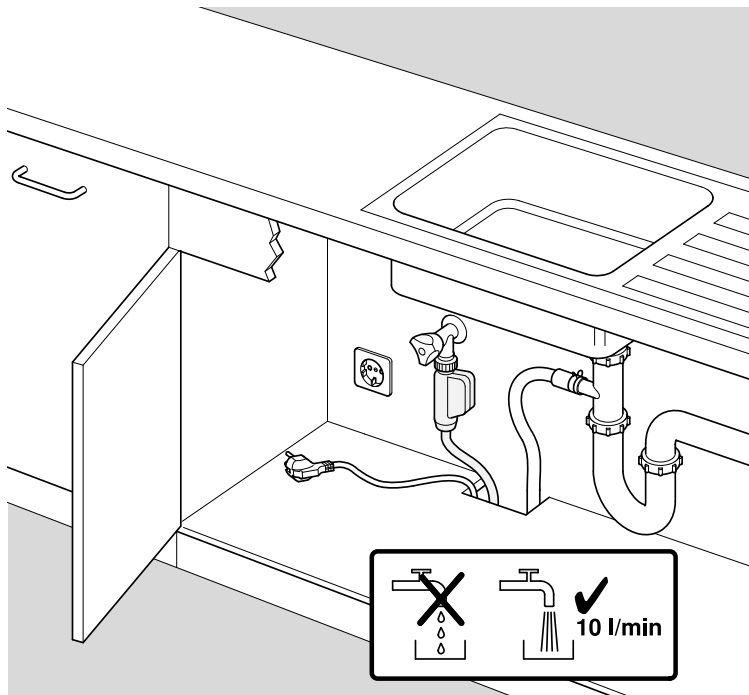

**Dichtheit prüfen**  
**Check for leaks**  
**Verifiez l'étanchéité**  
**Verificar la estanqueidad**



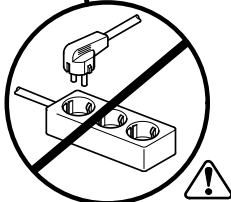
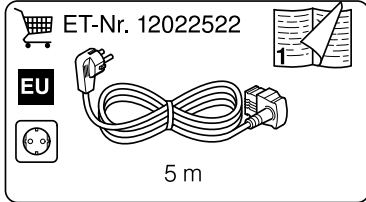
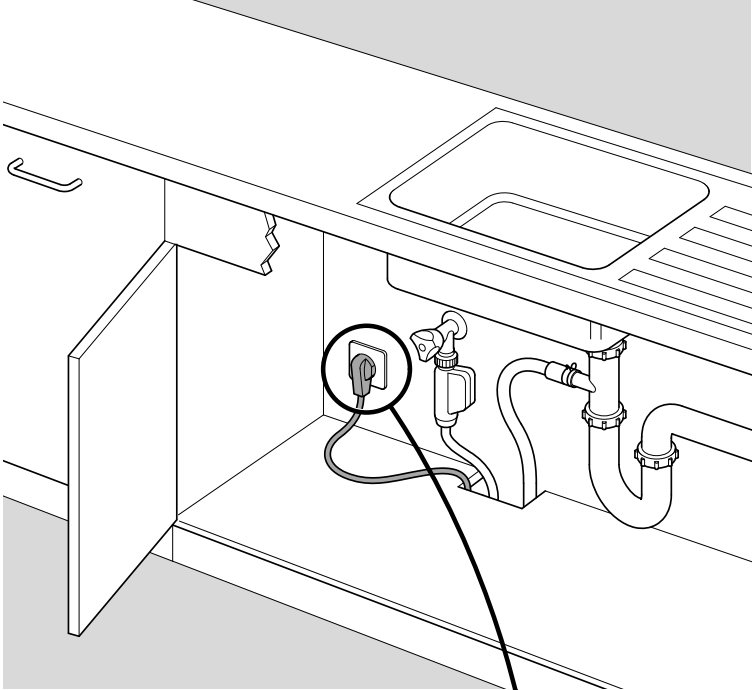
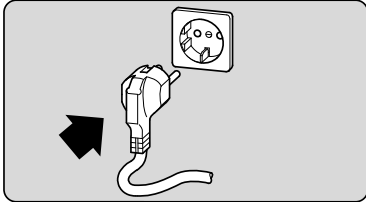



A series of horizontal lines for writing, starting from a vertical margin line on the left and extending to the right edge of the page. There are 20 horizontal lines in total, creating 19 rows of writing space.

