

<b>de</b>	Montageanleitung	<b>sr</b>	Uputstva za montažu
<b>en</b>	Installation instructions	<b>et</b>	Paigaldusjuhised
<b>fr</b>	Notice d'installation	<b>lt</b>	Įrengimo instrukcijos
<b>nl</b>	Installatie-instructies	<b>lv</b>	Uzstādīšanas instrukcijas
<b>it</b>	Istruzioni d'installazione	<b>sk</b>	Pokyny na inštaláciu
<b>el</b>	Οδηγίες εγκατάστασης	<b>sq</b>	Udhëzimet e instalimit
<b>es</b>	Instrucciones de montaje	<b>fa</b>	دستورالعمل نصب
<b>pt</b>	Instruções de instalação	<b>ar</b>	تعليمات التركيب
<b>sv</b>	Installationsanvisningar	<b>ko</b>	설치 설명서
<b>no</b>	Installasjonsveiledning	<b>zh</b>	安装说明
<b>fi</b>	Asennusohjeet	<b>uk</b>	Інструкція з монтажу
<b>da</b>	Installationsvejledning	<b>ro</b>	Instrucțiuni de instalare
<b>tr</b>	Kurulum talimatları	<b>bg</b>	Инструкции за монтаж
<b>ru</b>	Инструкция по установке	<b>ja</b>	設置説明書
<b>cs</b>	Pokyny k instalaci	<b>he</b>	הוראות התקנה
<b>pl</b>	Instrukcje montażu	<b>id</b>	Petunjuk pemasangan
<b>hu</b>	Telepítési útmutató	<b>kk</b>	Орнату нұсқаулықтар
<b>hr</b>	Upute za instalaciju	<b>zh-hk</b>	安裝說明
<b>mk</b>	Упатства за инсталирање	<b>zh-tw</b>	安裝說明
<b>sl</b>	Navodila za montažo	<b>uz</b>	O'rnatish bo'yicha yo'riqnomalar



<b>de</b>	über den Kundendienst erhältlich	<b>sr</b>	može se dobiti preko korisničkog servisa
<b>en</b>	Available from our after-sales service	<b>et</b>	saadaval hooldekeskuse kaudu
<b>fr</b>	disponible via le service après-vente	<b>lt</b>	galima įsigyti klientų aptarnavimo tarnyboje
<b>nl</b>	bij de servicedienst verkrijgbaar	<b>lv</b>	var saņemt klientu apkalpošanas dienestā
<b>it</b>	disponibile presso il servizio di assistenza clienti	<b>sk</b>	dostupné prostredníctvom zákazníckeho servisu
<b>el</b>	διαθέσιμο από την υπηρεσία εξυπηρέτησης πελατών	<b>sq</b>	marrja e mundshme përmes shërbimit të klientit
<b>es</b>	disponible a través del Servicio de Atención al Cliente	<b>fa</b>	در مرکز خدمات مشتریان موجود است
<b>pt</b>	pode ser adquirido nos nossos Serviços Técnicos	<b>ar</b>	يمكن الحصول عليها من خدمة العملاء
<b>sv</b>	går att beställa via service	<b>ko</b>	고객 서비스센터를 통해 구입 가능
<b>no</b>	fås hos kundeservice	<b>zh</b>	可向客户服务索取
<b>fi</b>	saatavissa huoltopalvelusta	<b>uk</b>	Через сервісну службу
<b>da</b>	Fås hos kundeservice	<b>ro</b>	se pot obține de la serviciul de asistență pentru clienți
<b>tr</b>	müşteri hizmetlerinden temin edilebilir	<b>bg</b>	предоставя се от службата за обслужване на клиенти
<b>ru</b>	можно приобрести через сервисную службу	<b>ja</b>	カスタマーサービスを通じて入手可能
<b>cs</b>	k dostání v zákaznickém servisu	<b>he</b>	זמין דרך שירות הלקוחות
<b>pl</b>	do nabycia w punkcie serwisowym	<b>id</b>	Tersedia di Layanan Pelanggan
<b>hu</b>	a vevőszolgálaton keresztül kapható	<b>kk</b>	сервистік қызмет арқылы алуға болады
<b>hr</b>	može se kupiti kod servisne službe	<b>zh-hk</b>	可向售後服務站索取
<b>mk</b>	достапно преку сервисната служба	<b>zh-tw</b>	可向客戶服務單位索取
<b>sl</b>	na voljo prek pooblaščenega servisa	<b>uz</b>	otishdan keyingi xizmat orqali olish mumkin



Ø4X36 Ø4X30

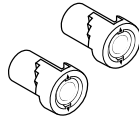
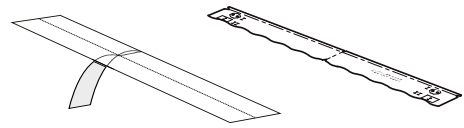
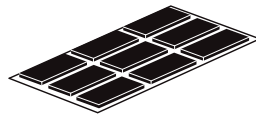

Ø4X15

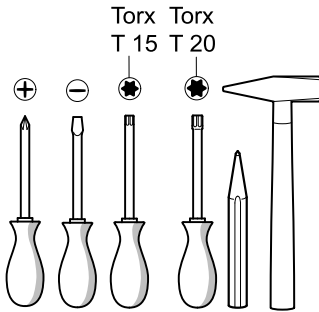
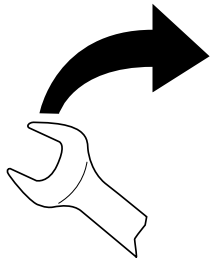
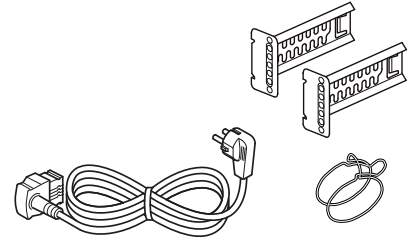
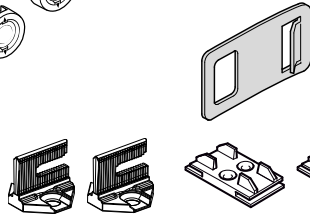
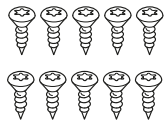

Torx  
T 15 T 20

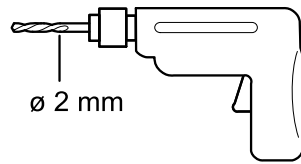
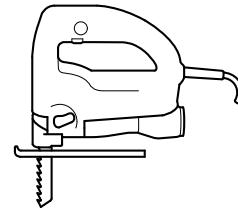
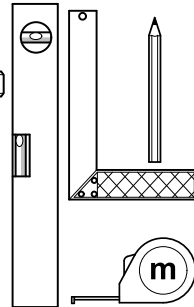
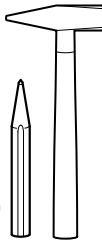

SW13

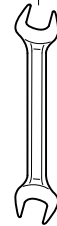

SW10

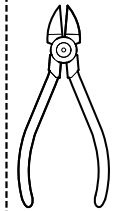
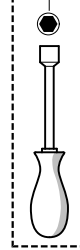

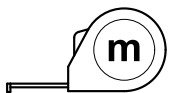
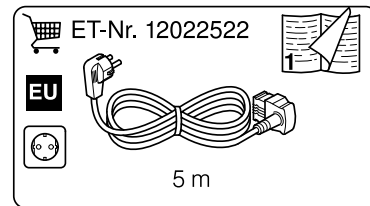
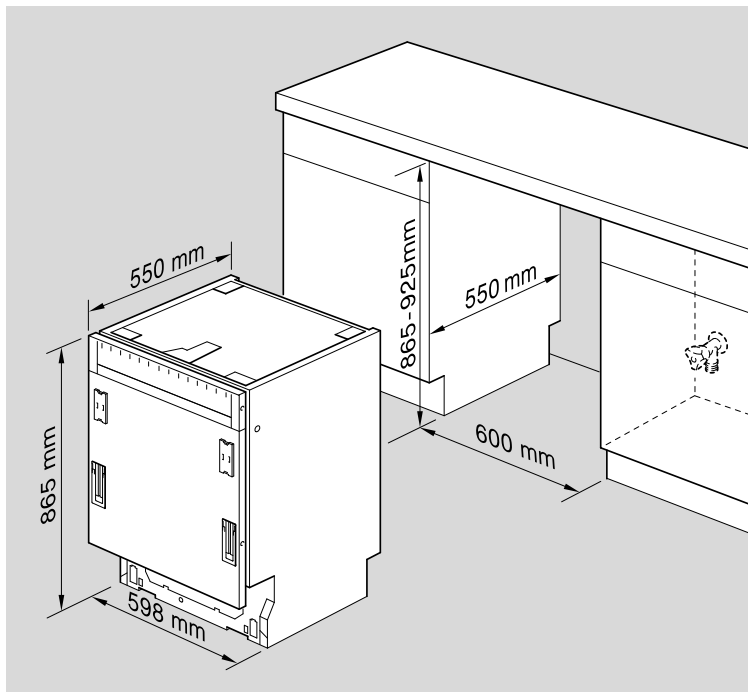
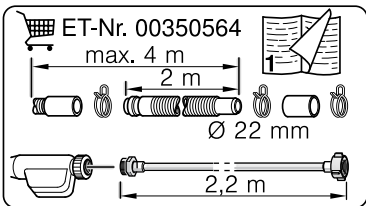
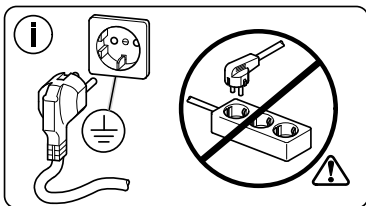
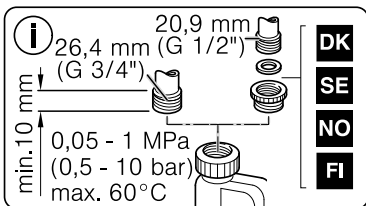
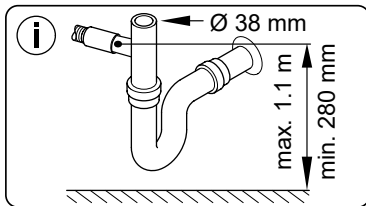

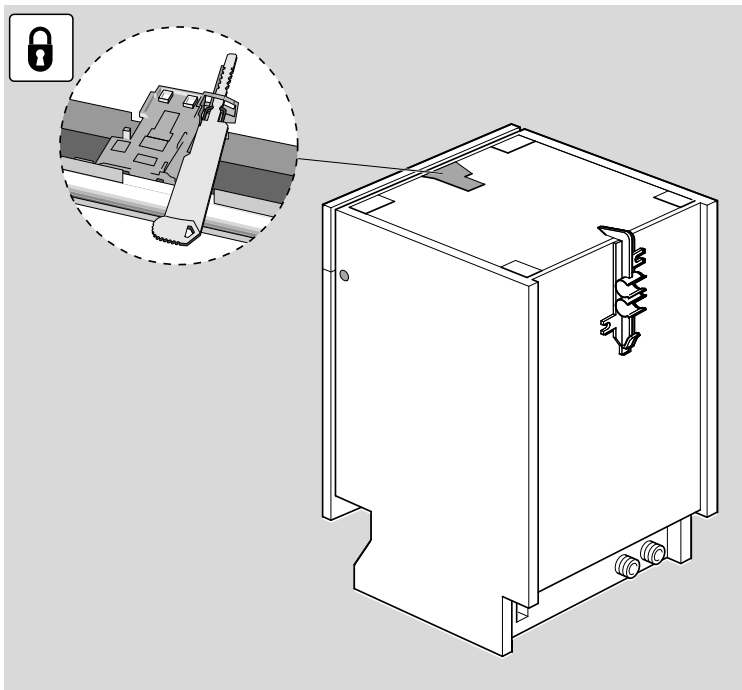
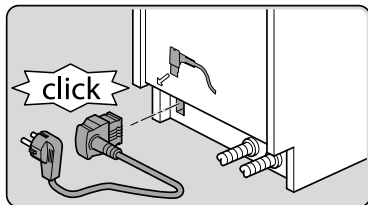
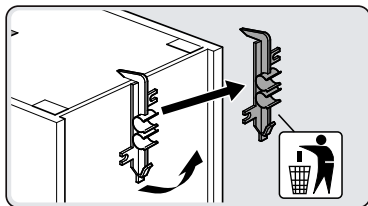
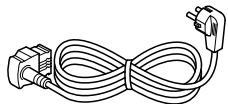

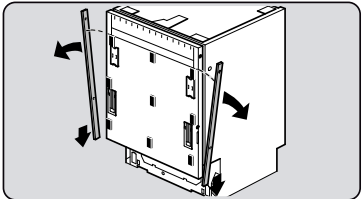
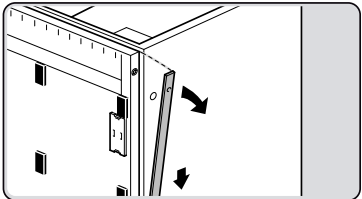
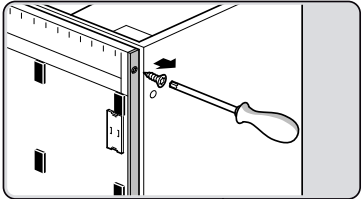
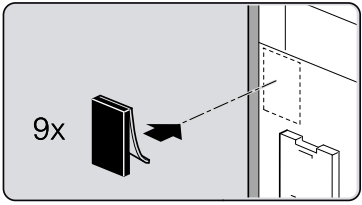
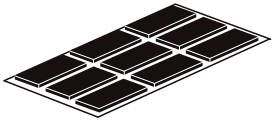

Torx  
T 15

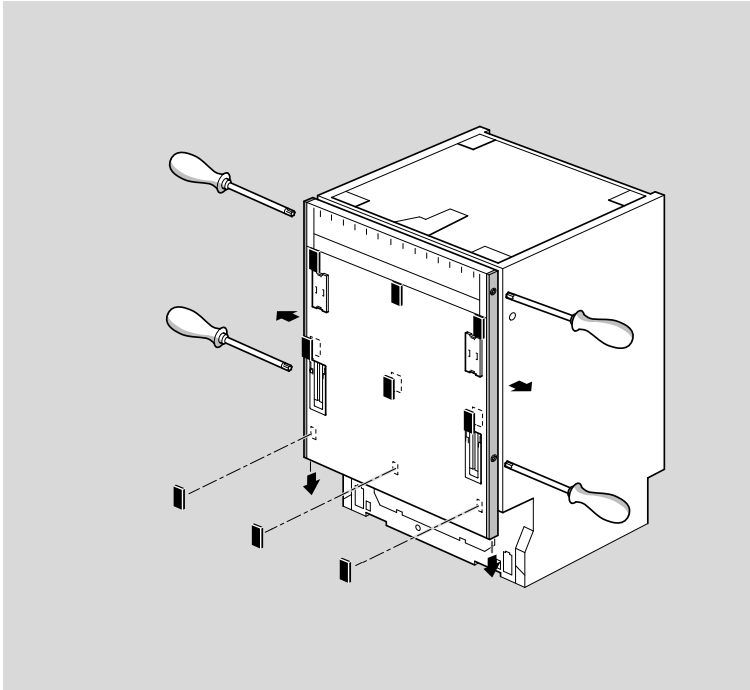
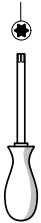

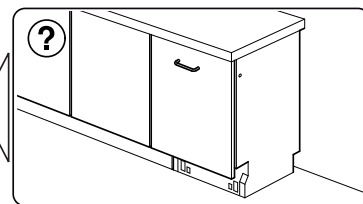
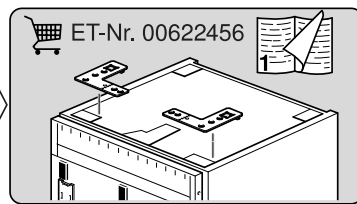
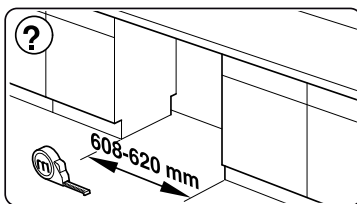
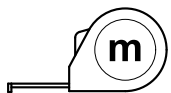
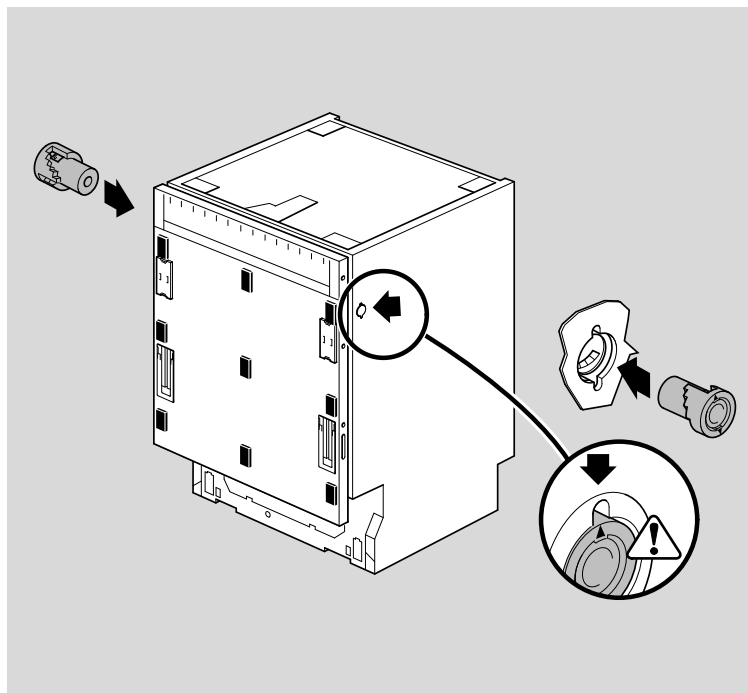
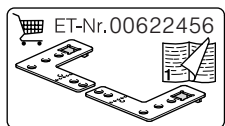
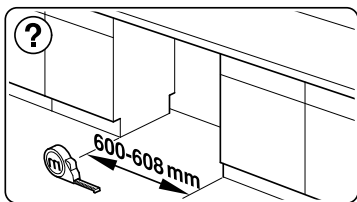

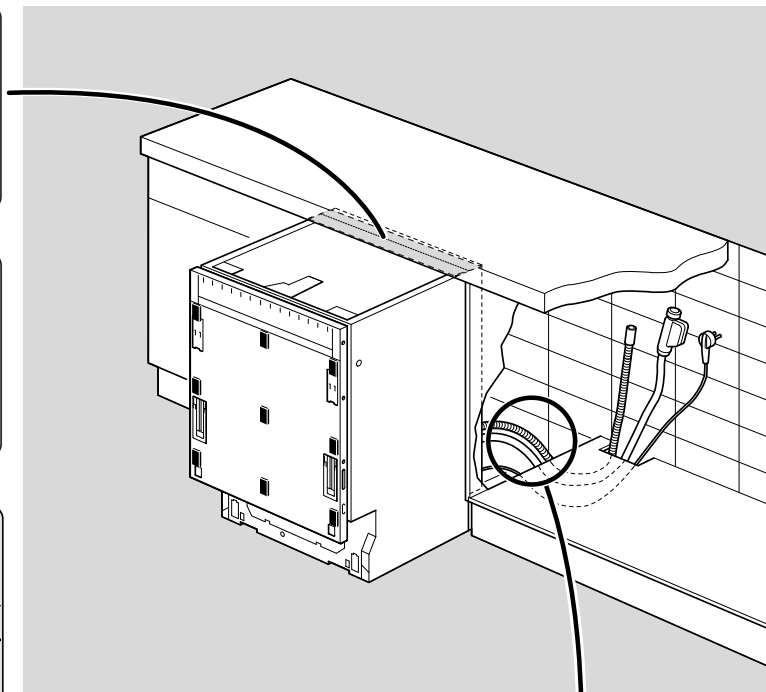
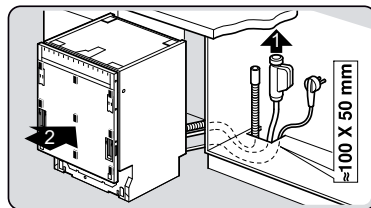
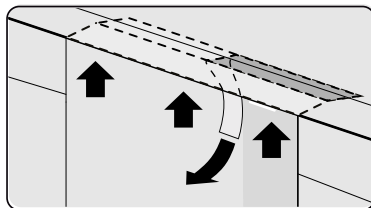
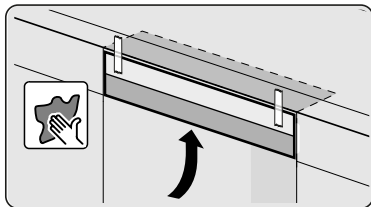
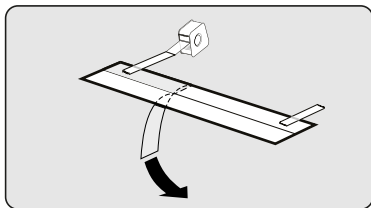
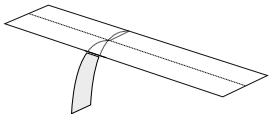

nicht einklemmen  
do not pinch  
ne pas coincer  
No doblar

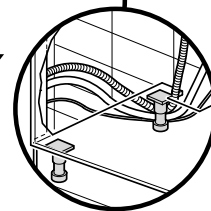



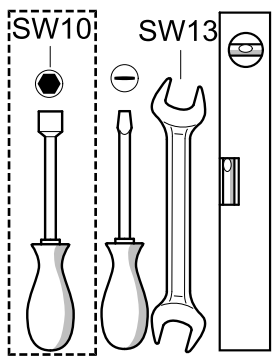
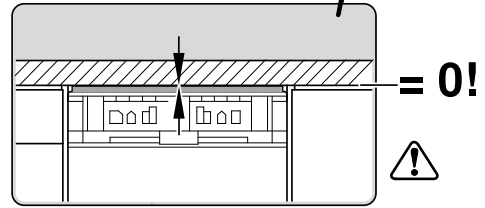

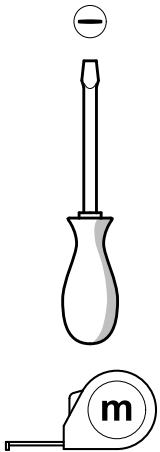
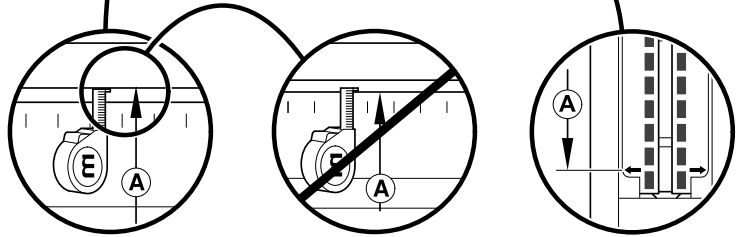
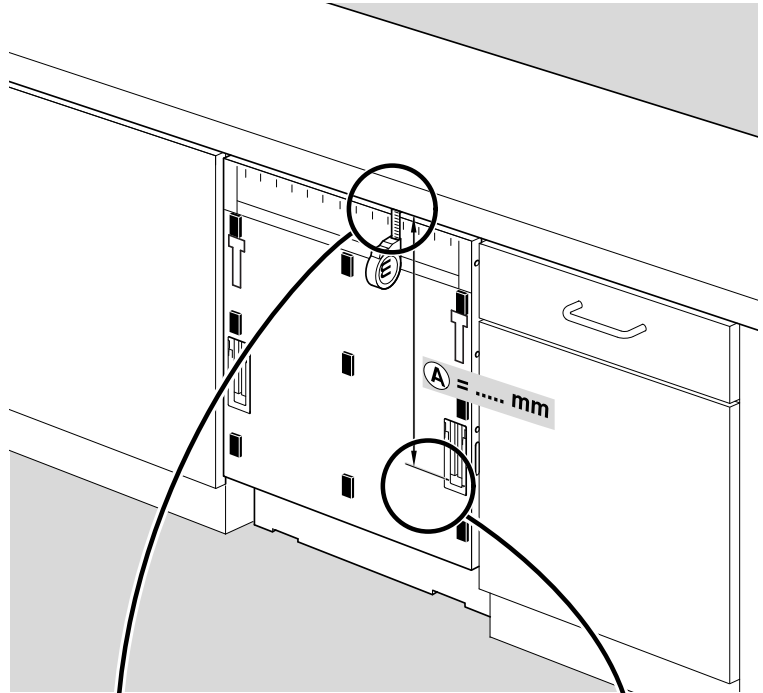
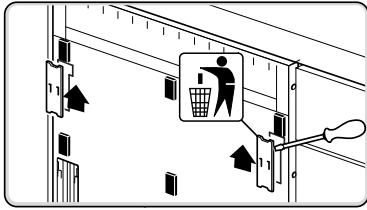

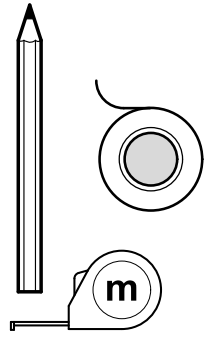
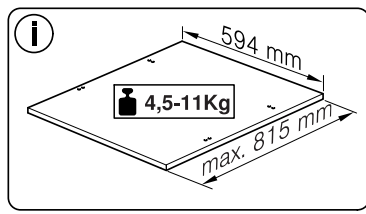
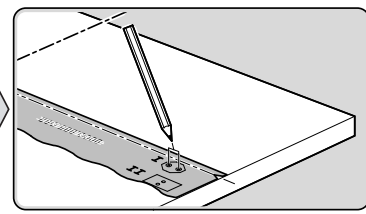
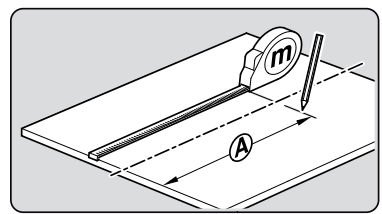
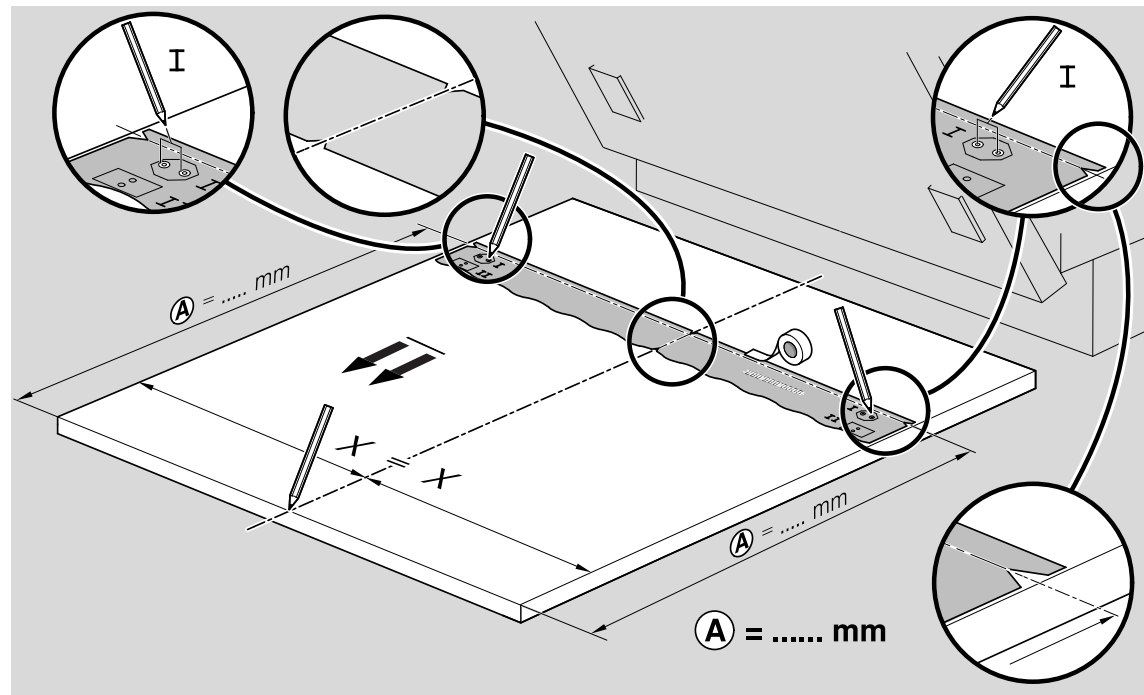

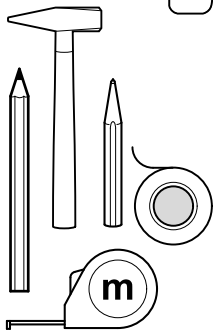
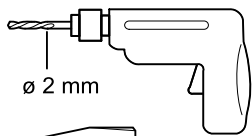
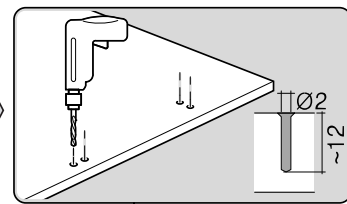
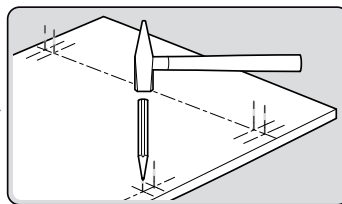
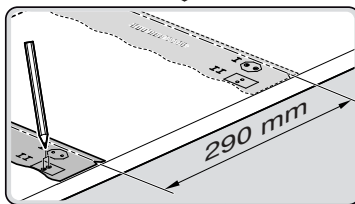
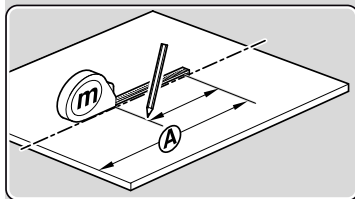
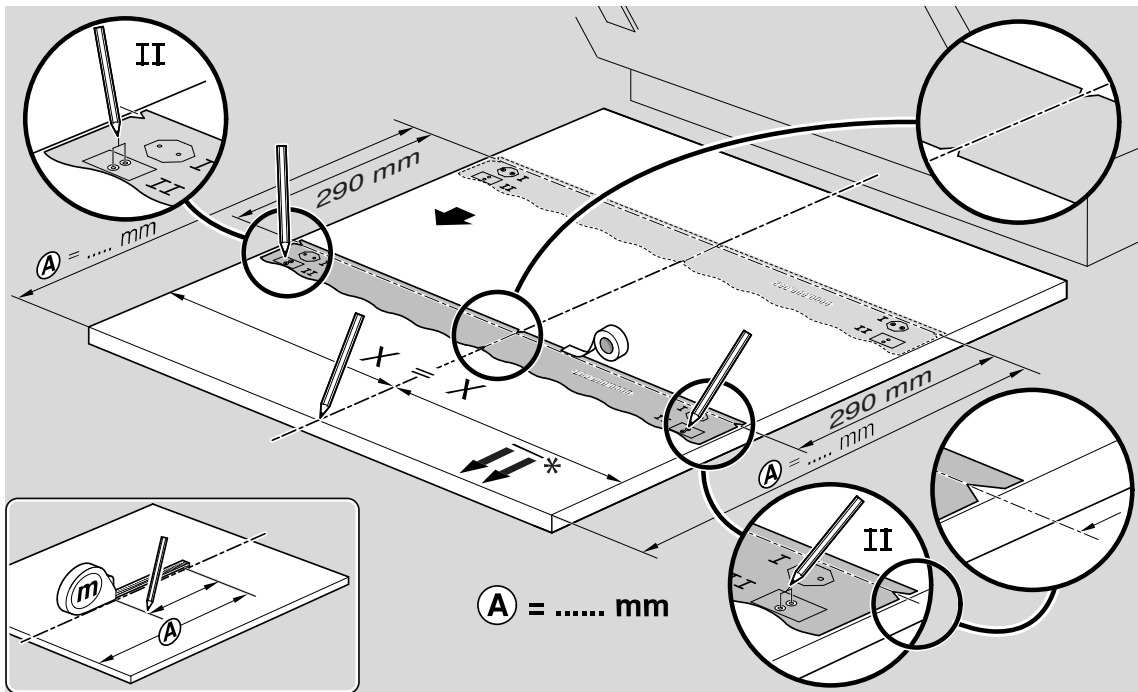
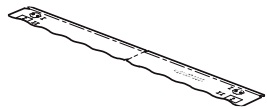

Ø4X15



Torx  
T 20



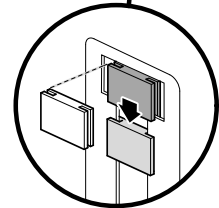
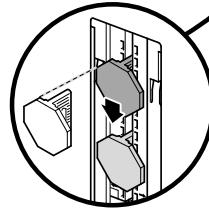
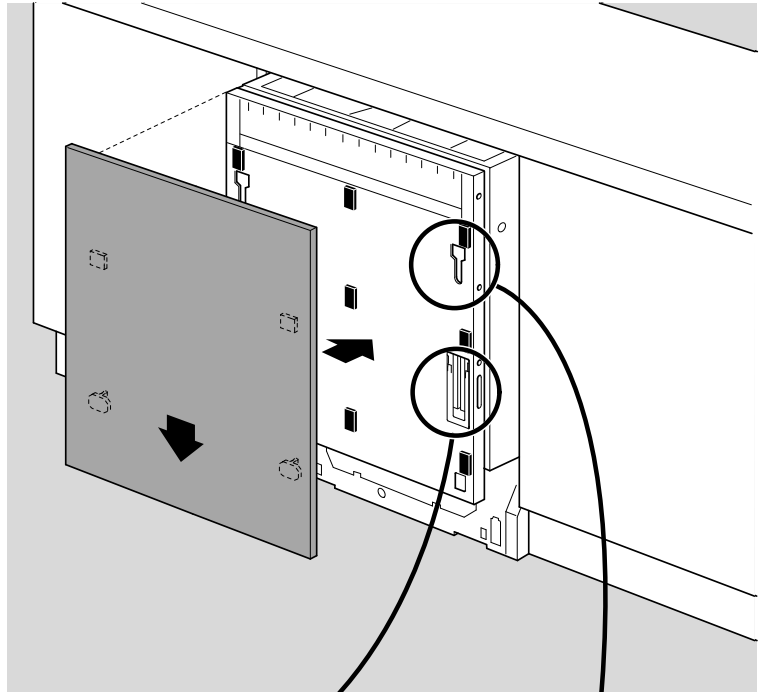
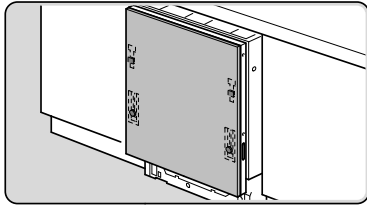

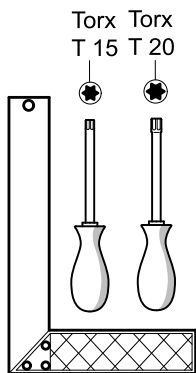
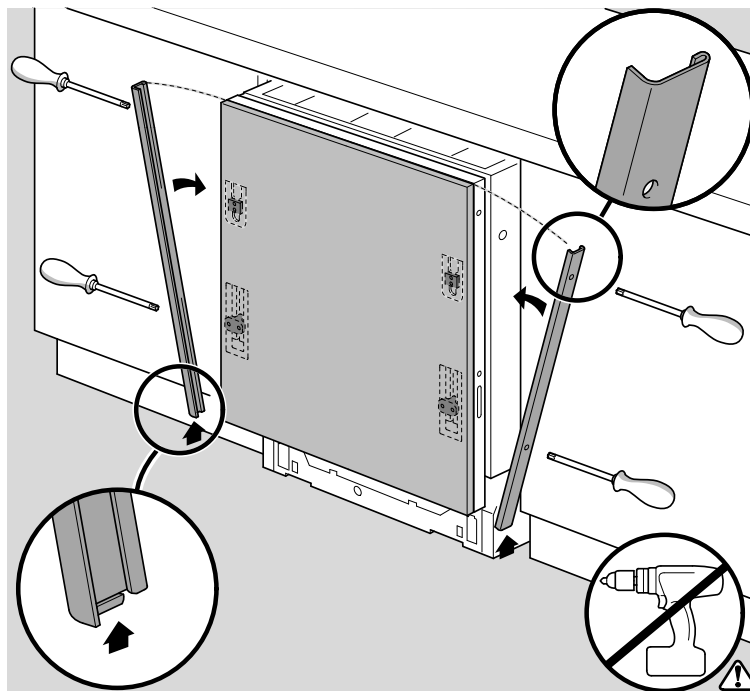
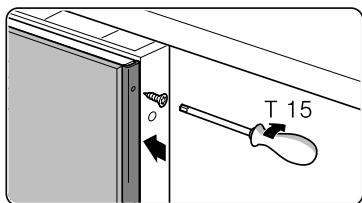
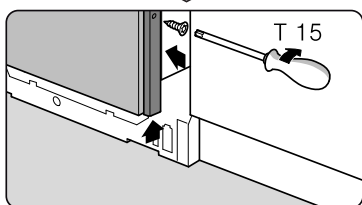
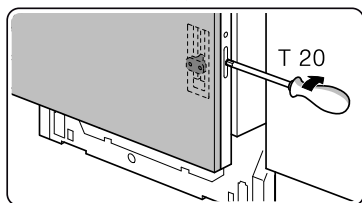
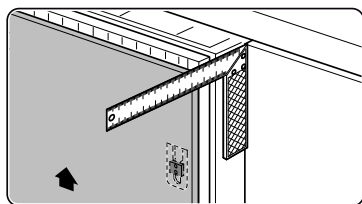

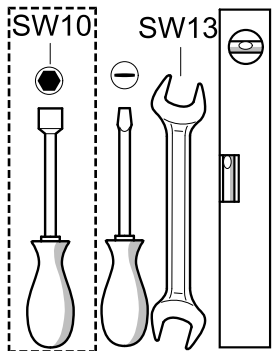
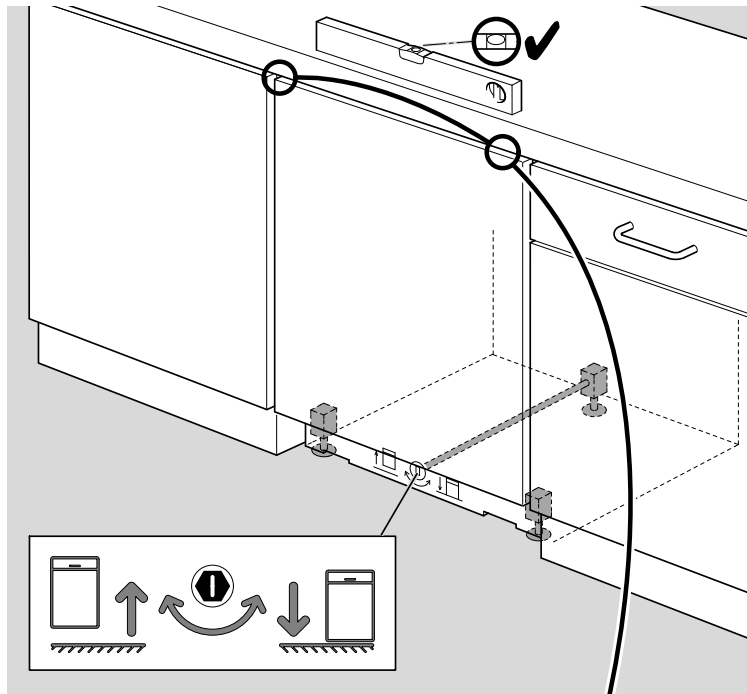
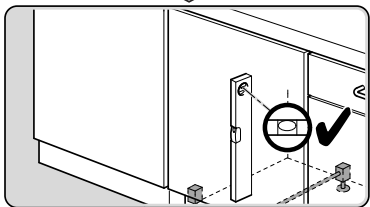
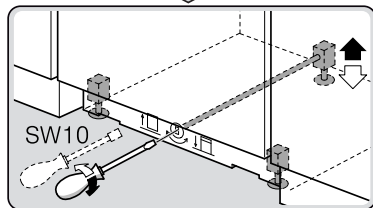
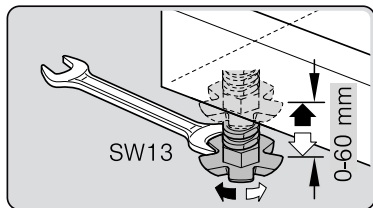

**verspannen**  
**brace**  
**calar verticalement**  
**Enrasar**

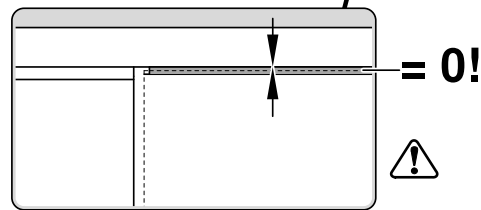



Ø4X30

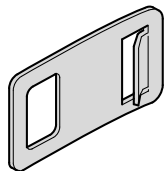

Torx  
T 20

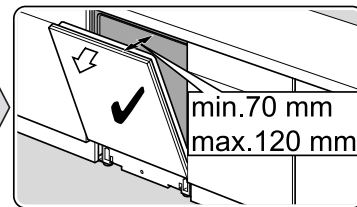
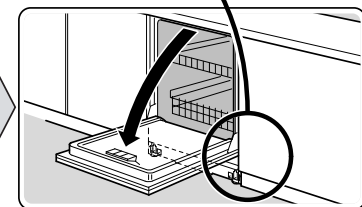
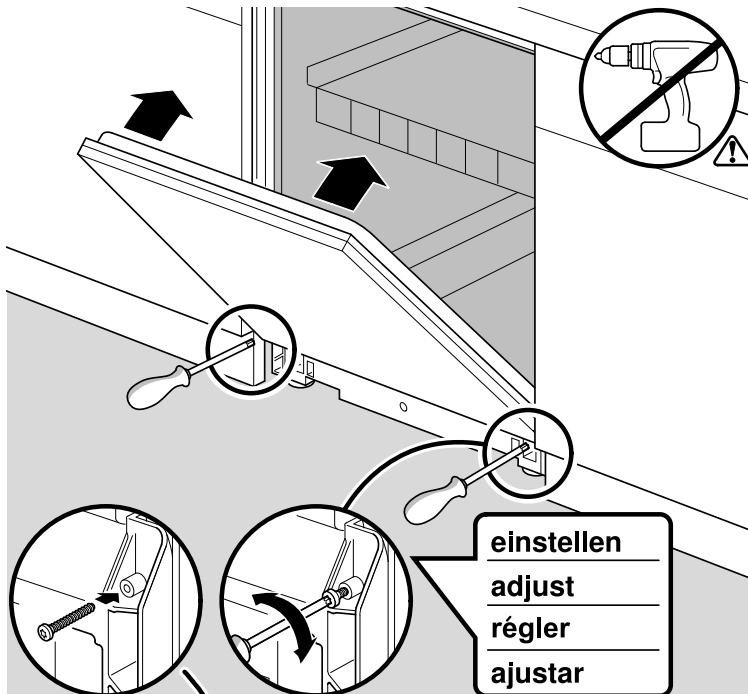
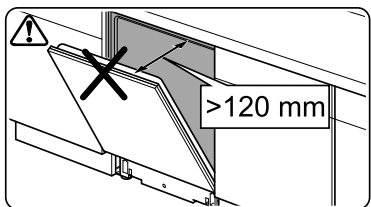
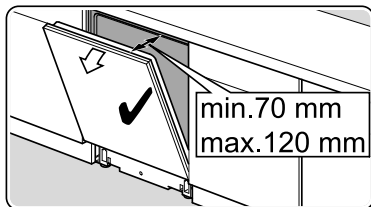
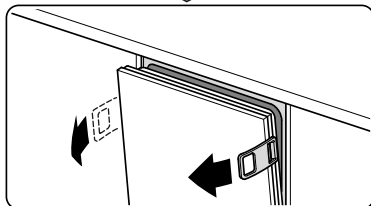
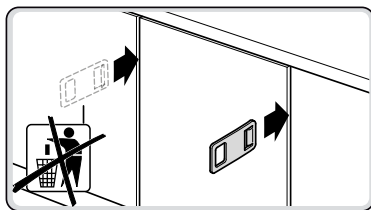
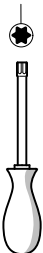

Ø4X36

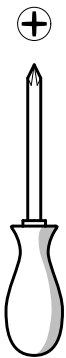
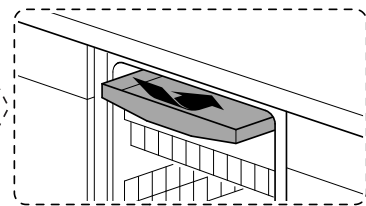
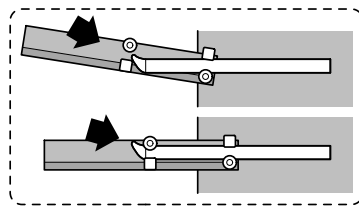
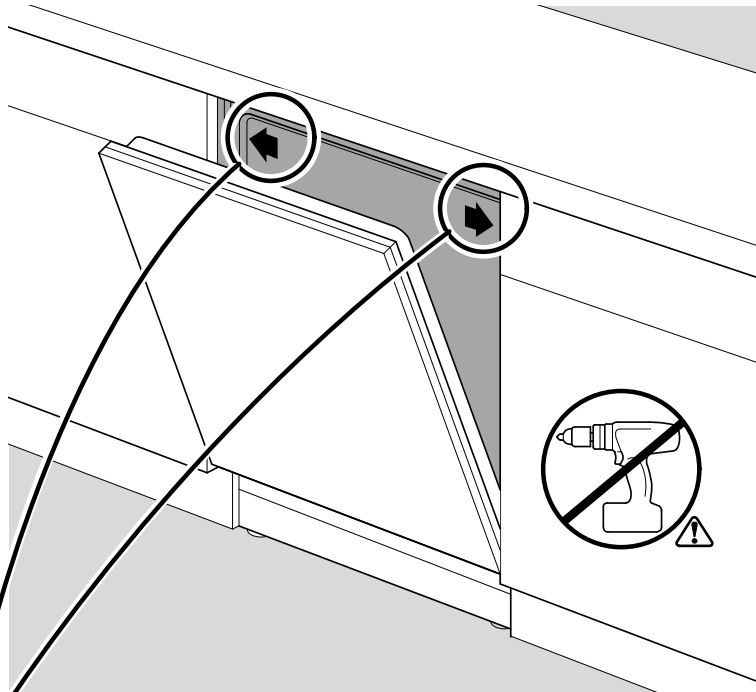
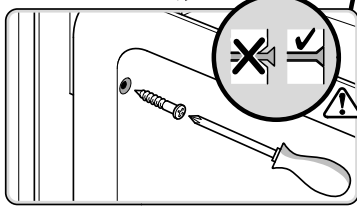
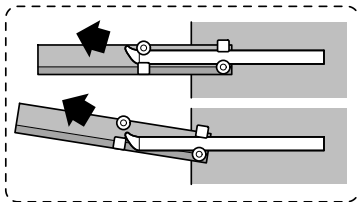
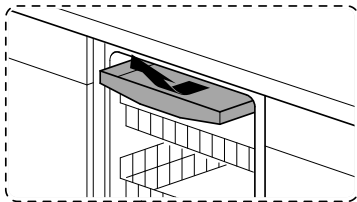
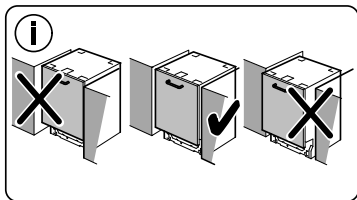
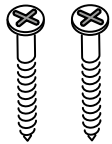

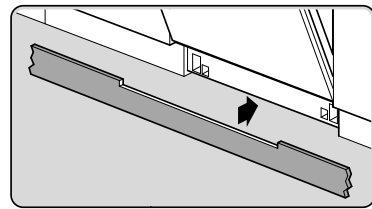
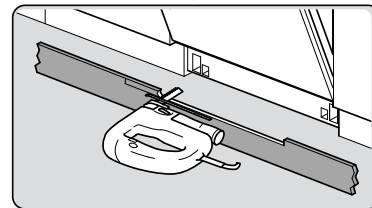
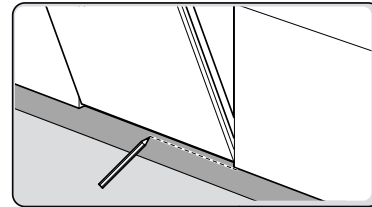
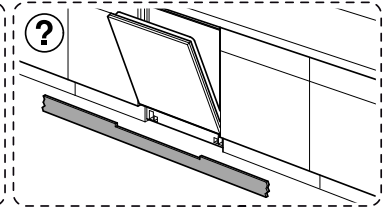
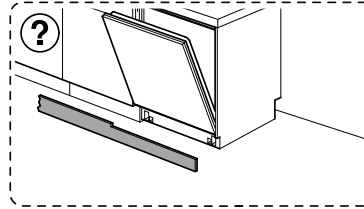
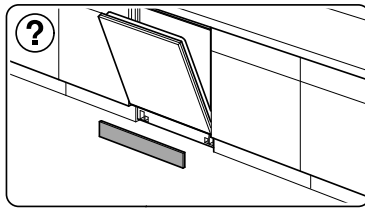
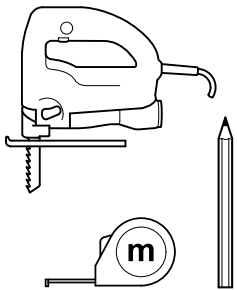

Ø4X15

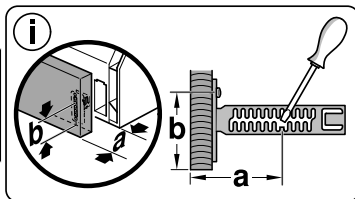
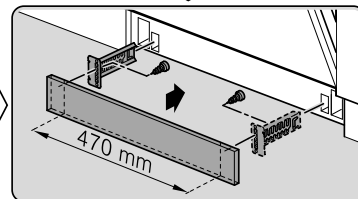
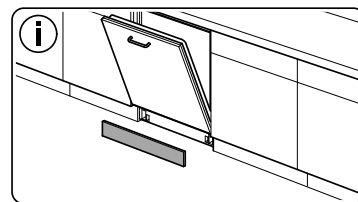
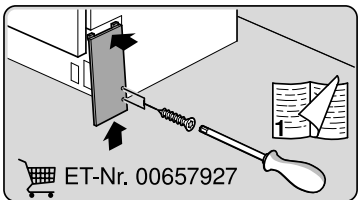
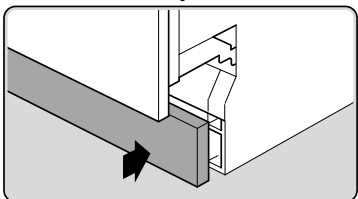
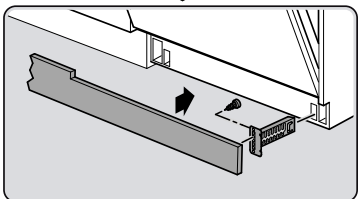
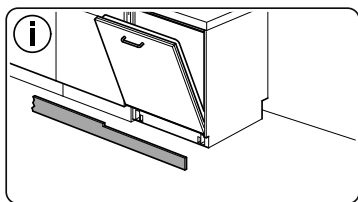
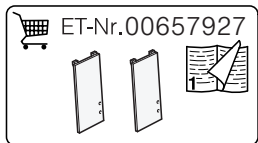
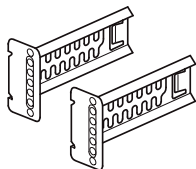

Torx  
T 20

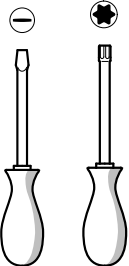

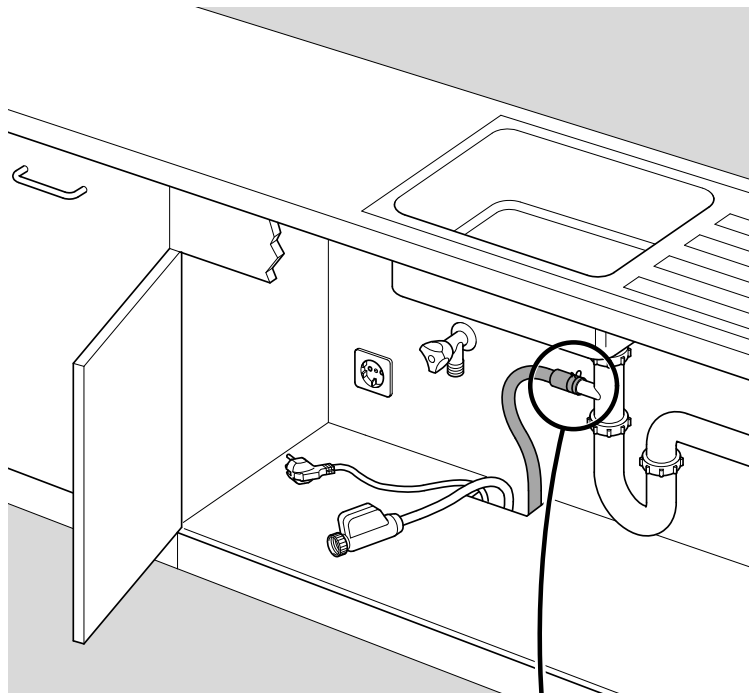
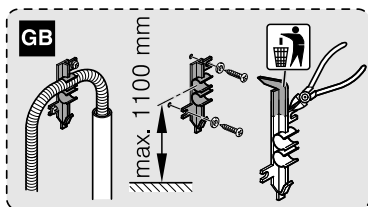
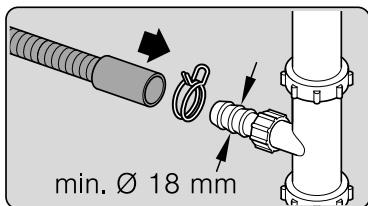
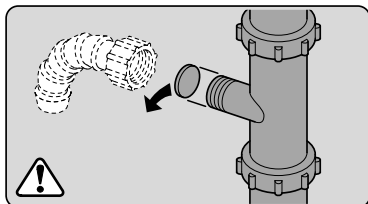
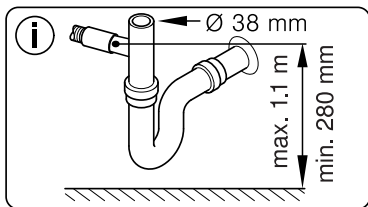
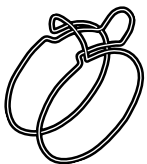

Dichtheit prüfen  
Check for leaks  
Verifiez l'étanchéité  
Verificar la estanqueidad

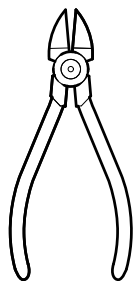
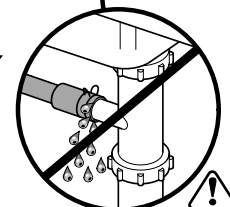

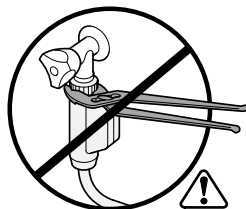
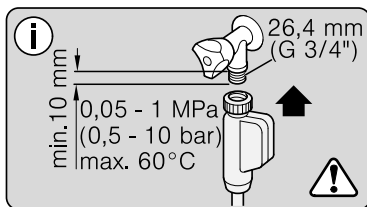

**max. 10 Nm**

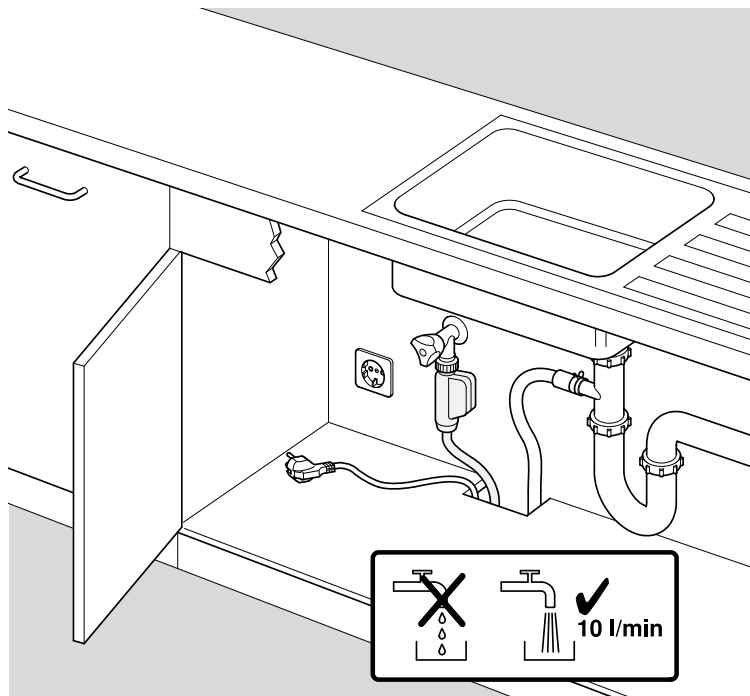

**Dichtheit prüfen**  
**Check for leaks**  
**Verifiez l'étanchéité**  
**Verificar la estanqueidad**



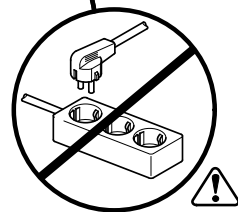
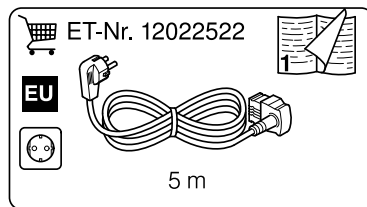
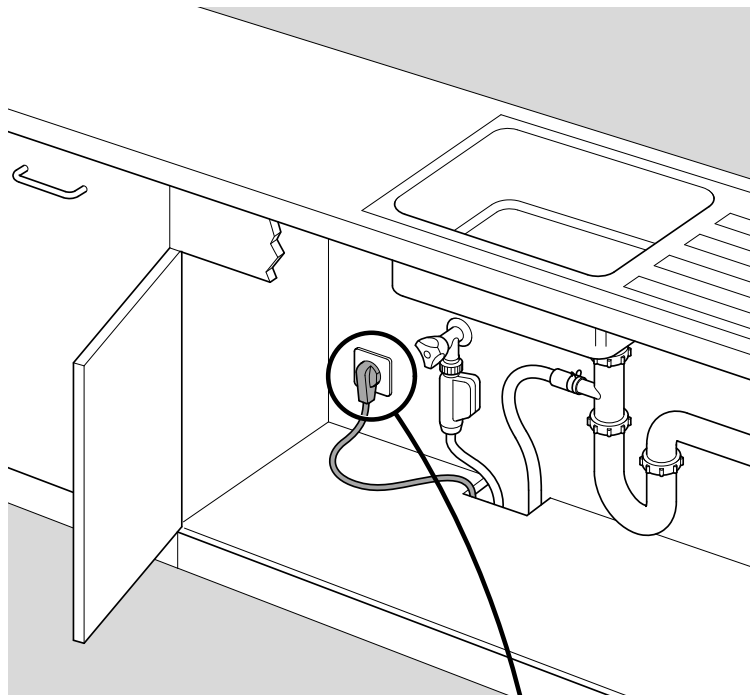
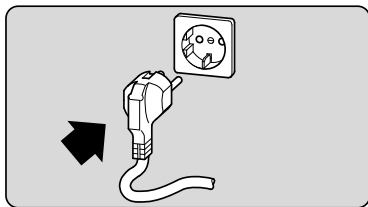



A series of horizontal lines for writing, starting from a vertical margin line on the left and extending to the right edge of the page. There are 20 horizontal lines in total, creating 19 rows of writing space.