



de	Montageanleitung	sr	Uputstva za montažu
en	Installation instructions	et	Paigaldusjuhised
fr	Notice d'installation	lt	Įrengimo instrukcijos
nl	Installatie-instructies	lv	Uzstādīšanas instrukcijas
it	Istruzioni d'installazione	sk	Pokyny na inštaláciu
el	Οδηγίες εγκατάστασης	sq	Udhëzimet e instalimit
es	Instrucciones de montaje	fa	دستورالعمل نصب
pt	Instruções de instalação	ar	تعليمات التركيب
sv	Installationsanvisningar	ko	설치 설명서
no	Installasjonsveiledning	zh	安装说明
fi	Asennusohjeet	uk	Інструкція з монтажу
da	Installationsvejledning	ro	Instrucțiuni de instalare
tr	Kurulum talimatları	bg	Инструкции за монтаж
ru	Инструкция по установке	ja	設置説明書
cs	Pokyny k instalaci	he	הוראות התקנה
pl	Instrukcje montażu	id	Petunjuk pemasangan
hu	Telepítési útmutató	kk	Орнату нұсқаулықтар
hr	Upute za instalaciju	zh-hk	安裝說明
mk	Упатства за инсталирање	zh-tw	安裝說明
sl	Navodila za montažo	uz	O'rnatish bo'yicha yo'riqnomalar



de	über den Kundendienst erhältlich	sr	može se dobiti preko korisničkog servisa
en	Available from our after-sales service	et	saadaval hooldekeskuse kaudu
fr	disponible via le service après-vente	lt	galima įsigyti klientų aptarnavimo tarnyboje
nl	bij de servicedienst verkrijgbaar	lv	var saņemt klientu apkalpošanas dienestā
it	disponibile presso il servizio di assistenza clienti	sk	dostupné prostredníctvom zákazníckeho servisu
el	διαθέσιμο από την υπηρεσία εξυπηρέτησης πελατών	sq	marrja e mundshme përmes shërbimit të klientit
es	disponible a través del Servicio de Atención al Cliente	fa	در مرکز خدمات مشتریان موجود است
pt	pode ser adquirido nos nossos Serviços Técnicos	ar	يمكن الحصول عليها من خدمة العملاء
sv	går att beställa via service	ko	고객 서비스센터를 통해 구입 가능
no	fås hos kundeservice	zh	可向客户服务索取
fi	saatavissa huoltopalvelusta	uk	Через сервісну службу
da	Fås hos kundeservice	ro	se pot obține de la serviciul de asistență pentru clienți
tr	müşteri hizmetlerinden temin edilebilir	bg	предоставя се от службата за обслужване на клиенти
ru	можно приобрести через сервисную службу	ja	カスタマーサービスを通じて入手可能
cs	k dostání v zákaznickém servisu	he	זמין דרך שירות הלקוחות
pl	do nabycia w punkcie serwisowym	id	Tersedia di Layanan Pelanggan
hu	a vevőszolgálaton keresztül kapható	kk	сервистік қызмет арқылы алуға болады
hr	može se kupiti kod servisne službe	zh-hk	可向售後服務站索取
mk	достапно преку сервисната служба	zh-tw	可向客戶服務單位索取
sl	na voljo prek pooblaščenega servisa	uz	otishdan keyingi xizmat orqali olish mumkin



Ø4X28

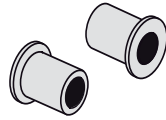
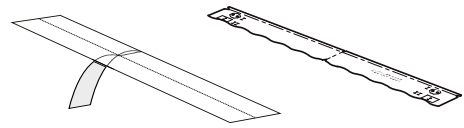
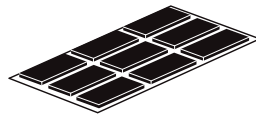

Ø4X15

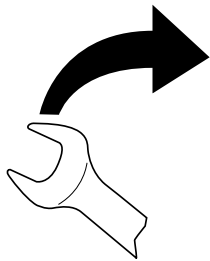
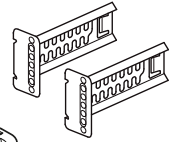
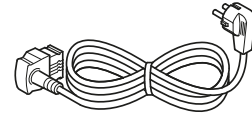
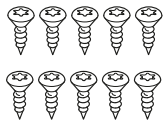

Torx
T 15 T 20

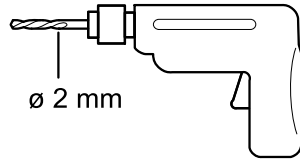
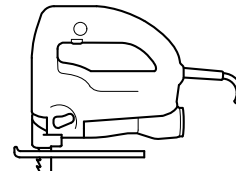
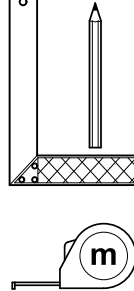
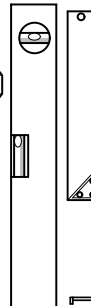
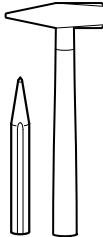
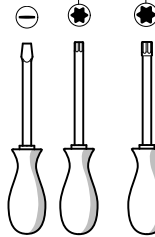

SW13

SW10

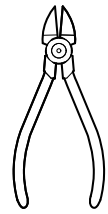
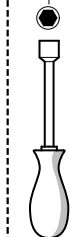
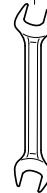

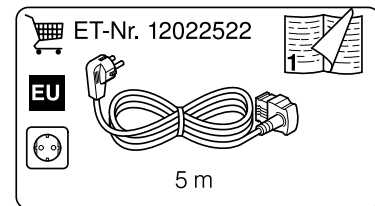
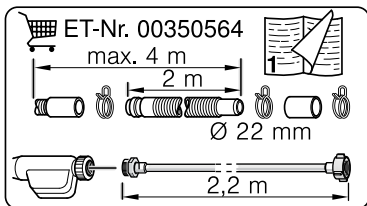
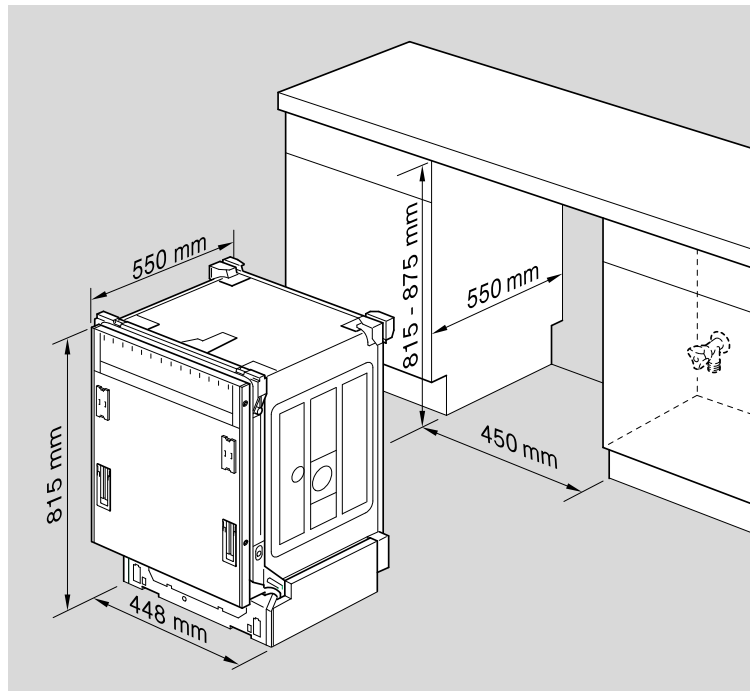
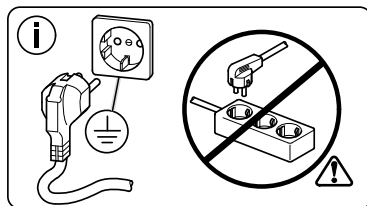
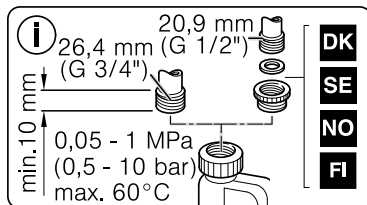
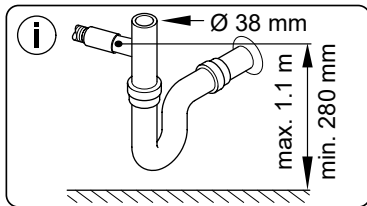

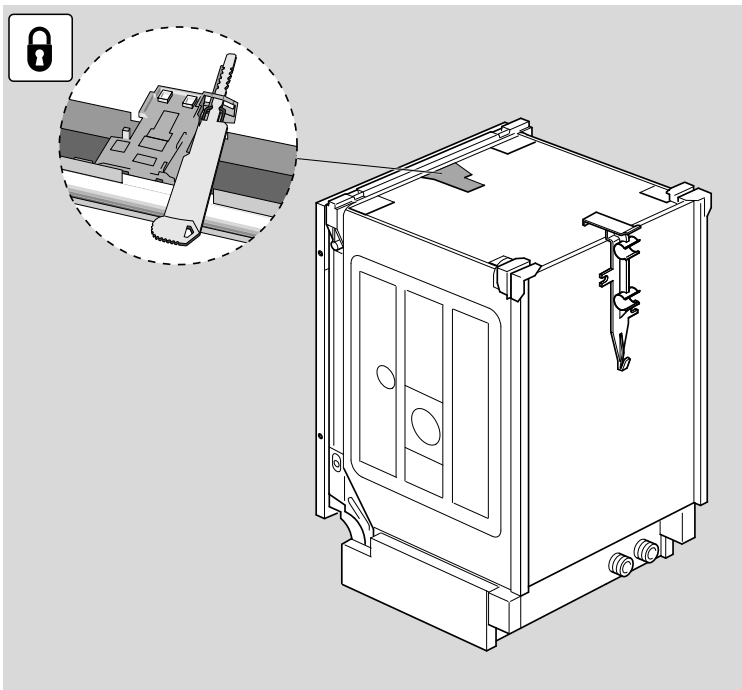
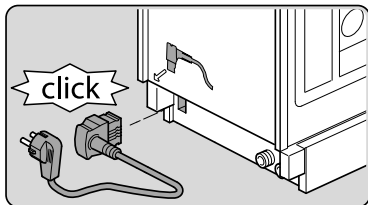
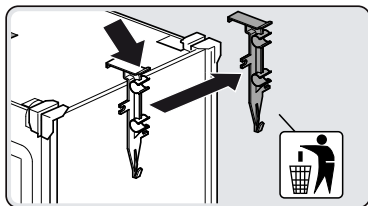
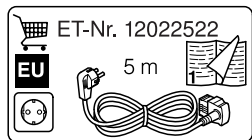

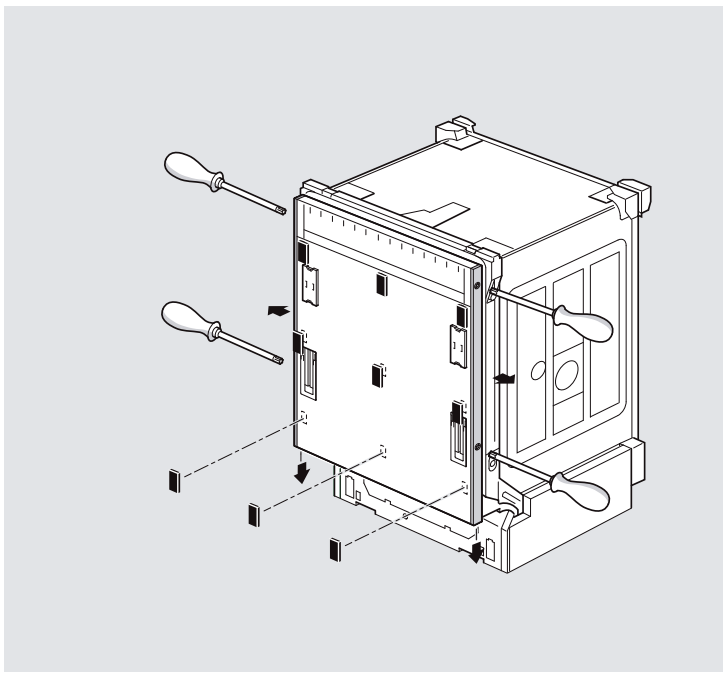
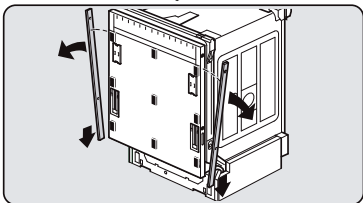
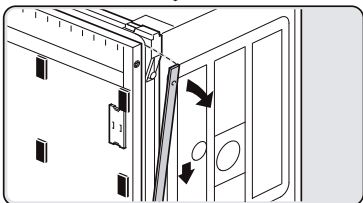
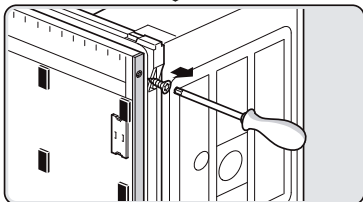
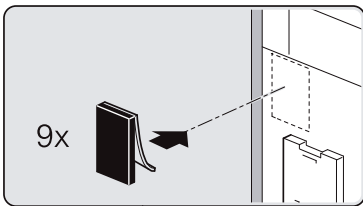
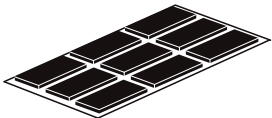

Torx
T 15



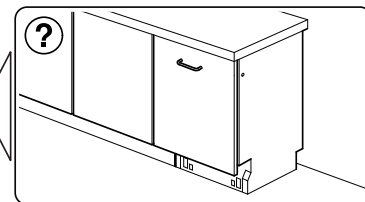
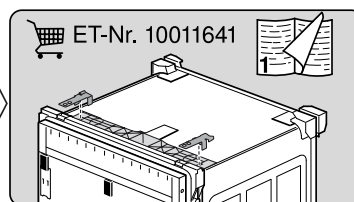
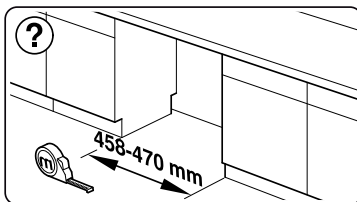
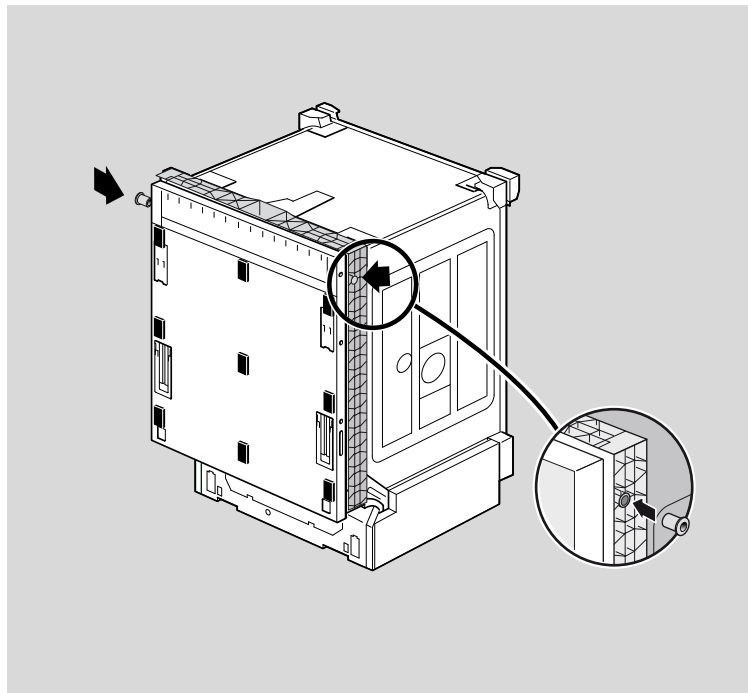
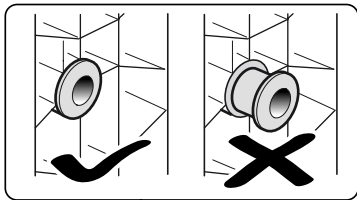
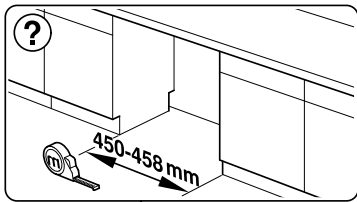
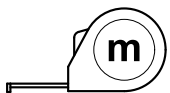
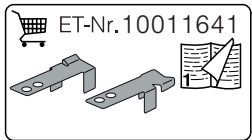
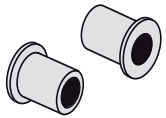

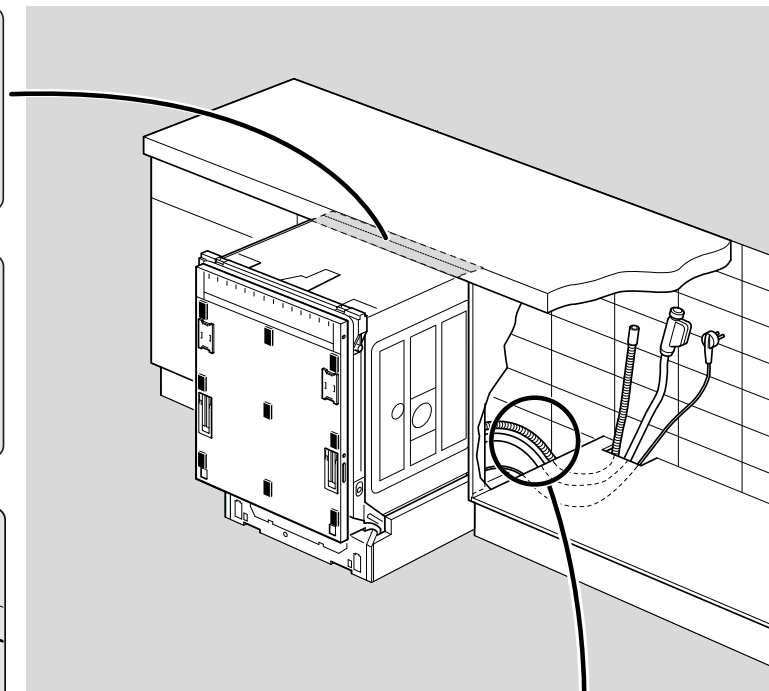
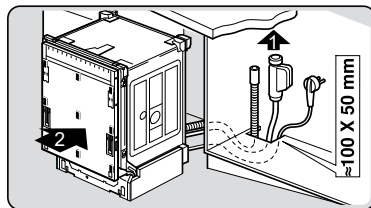
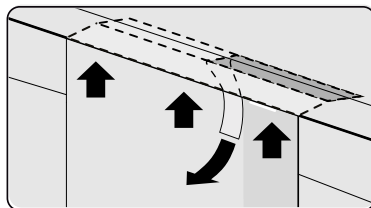
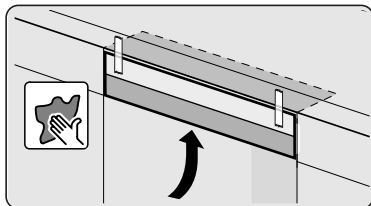
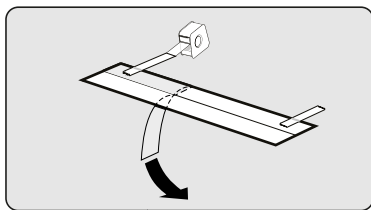

nicht einklemmen
do not pinch
ne pas coincer
No doblar

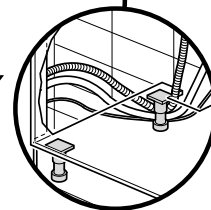

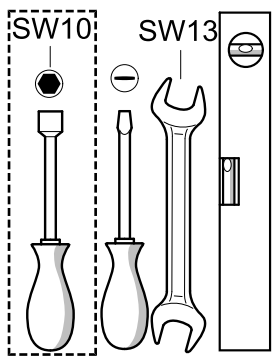
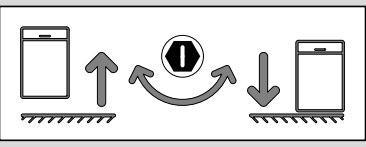
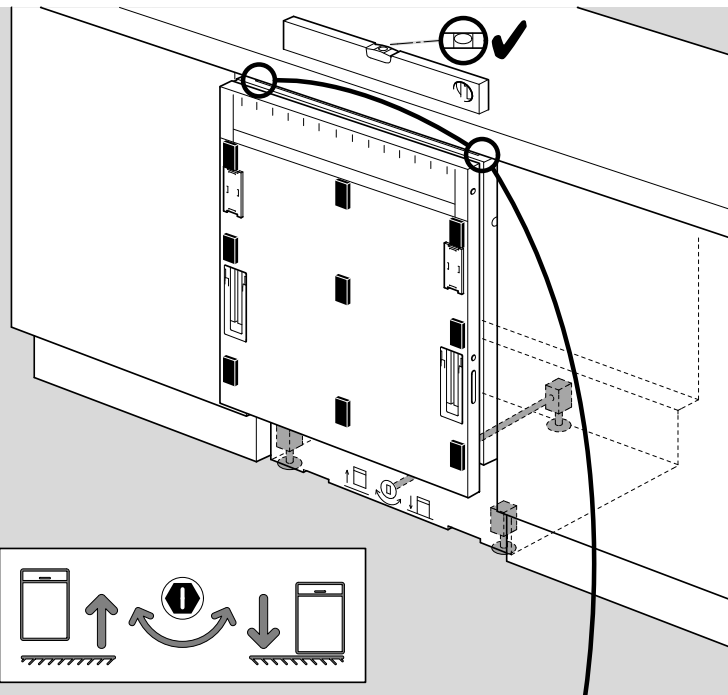
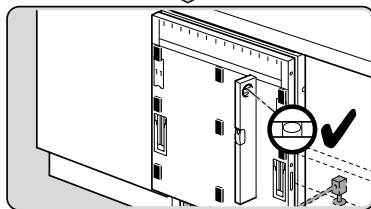
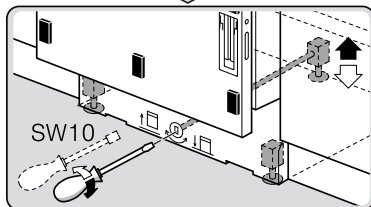
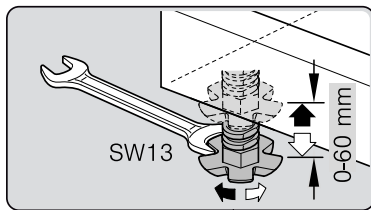

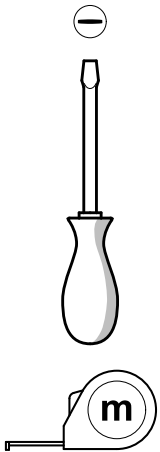
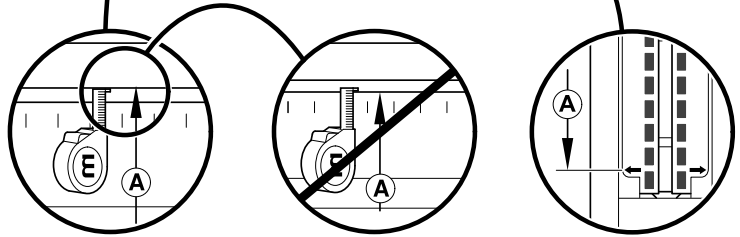
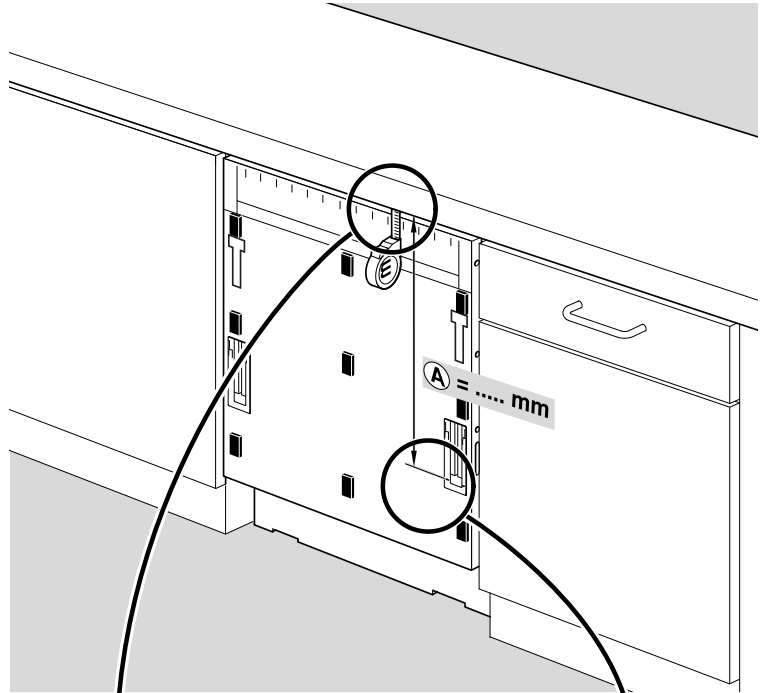
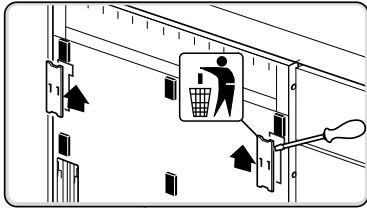

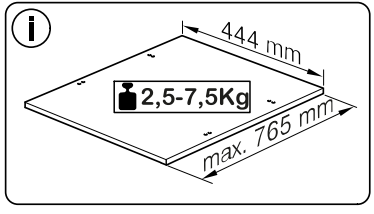
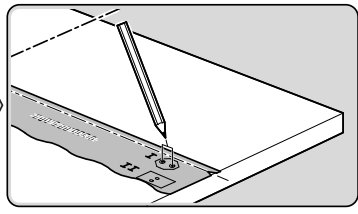
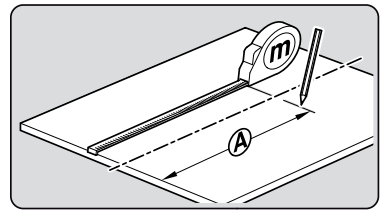
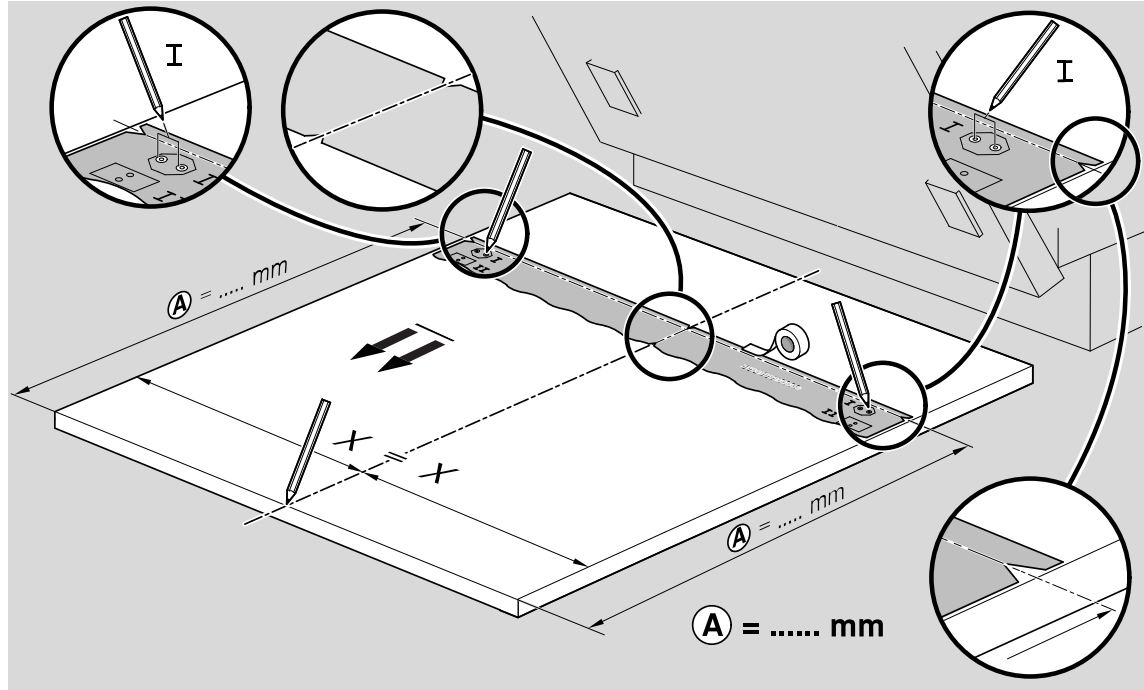
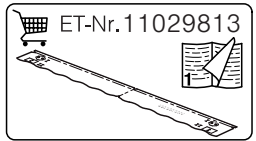

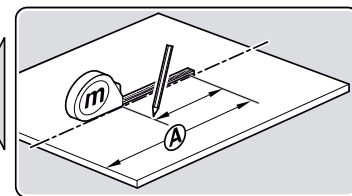
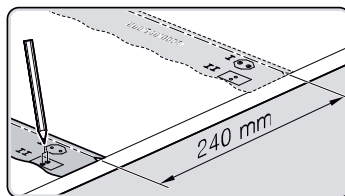
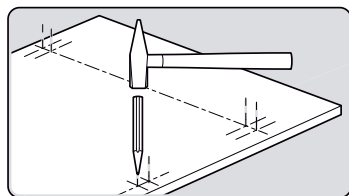
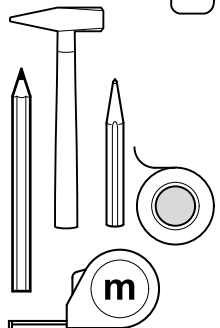
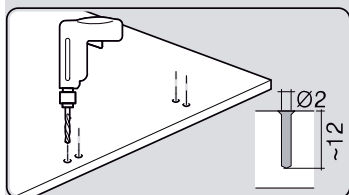
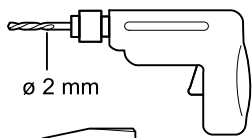
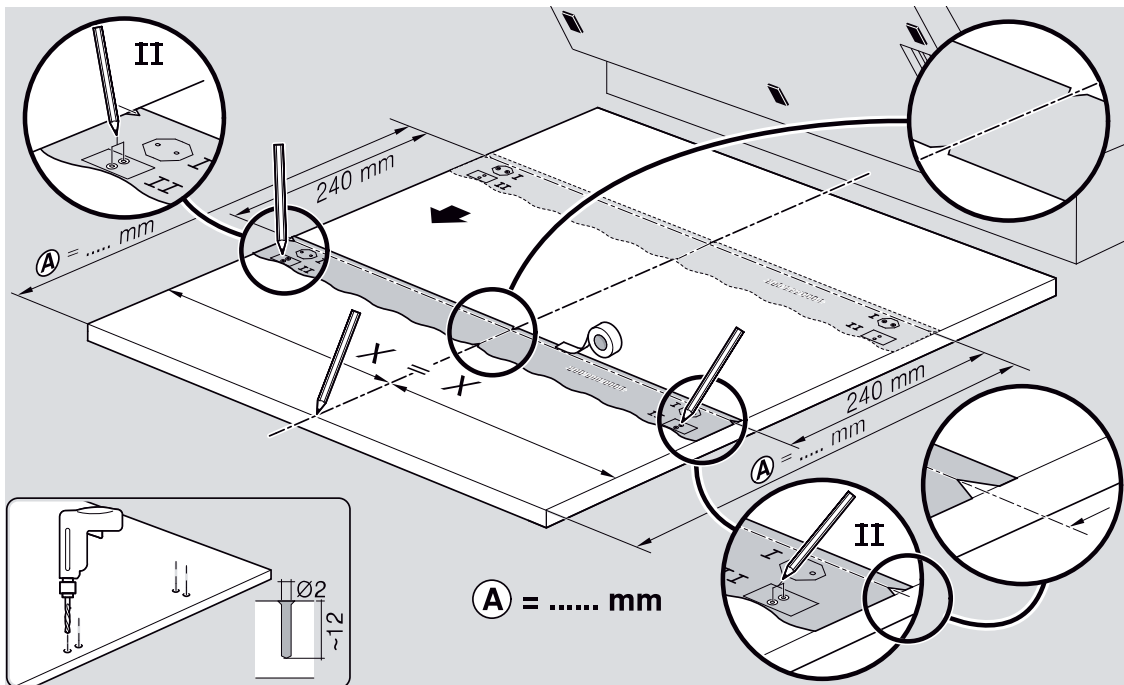
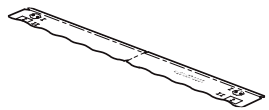

Ø4X15



Torx
T 20



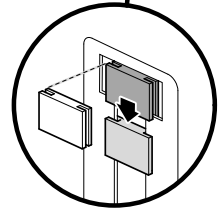
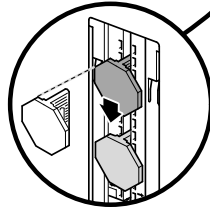
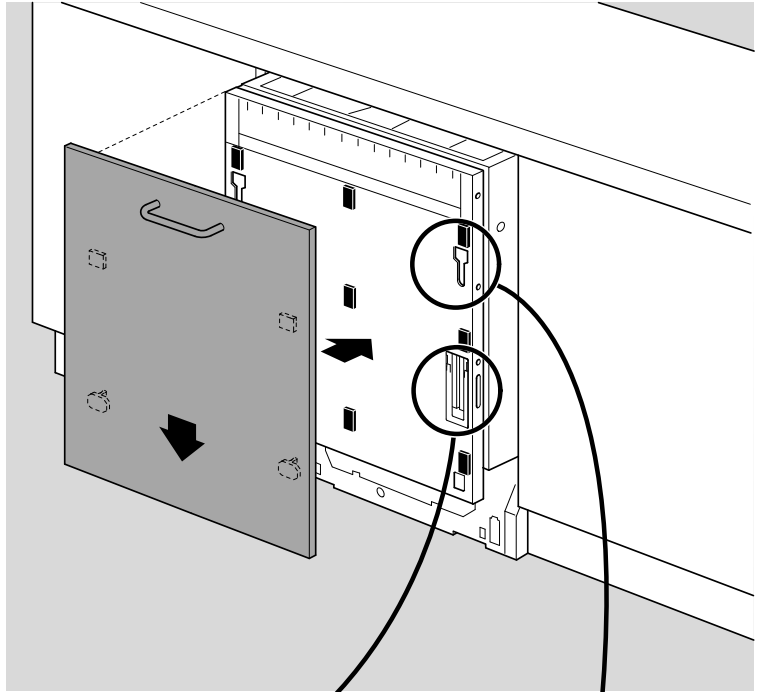
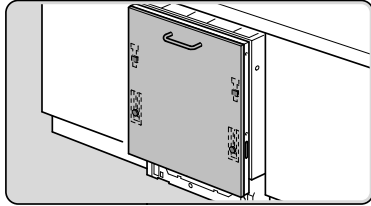
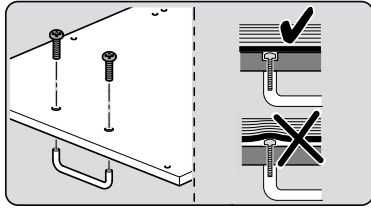

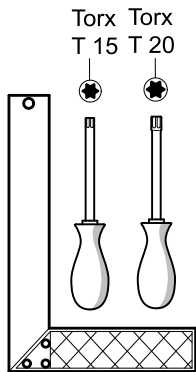
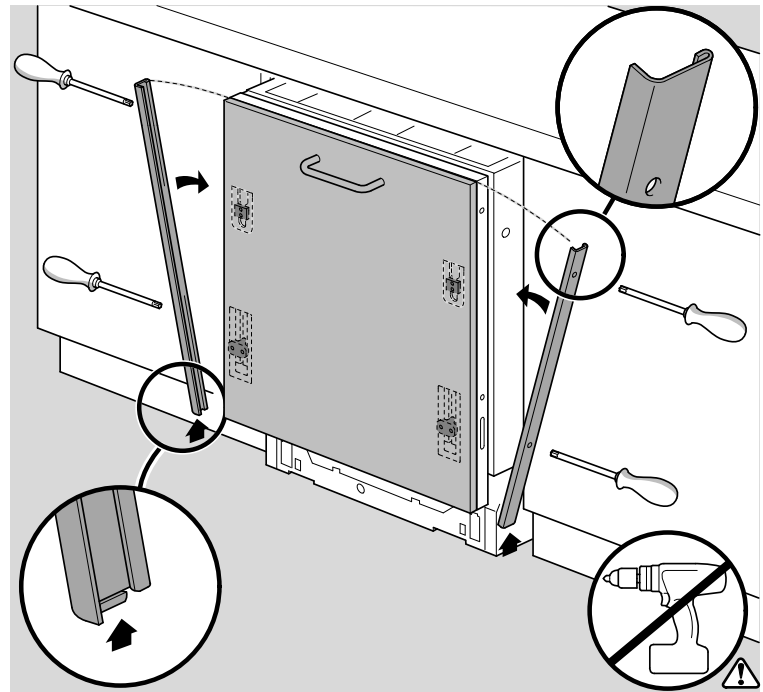
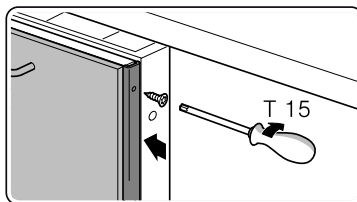
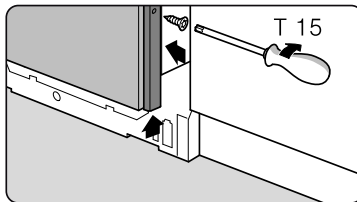
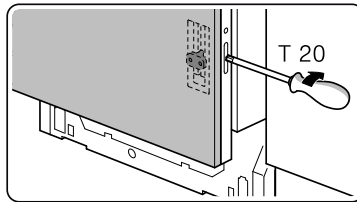
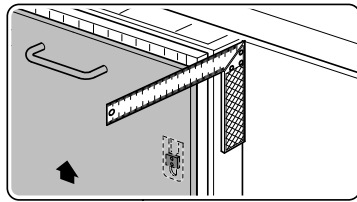

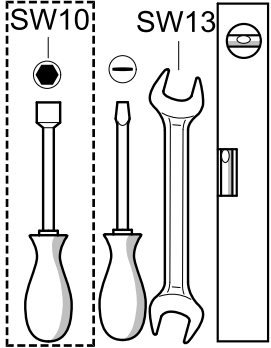
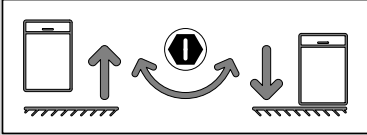
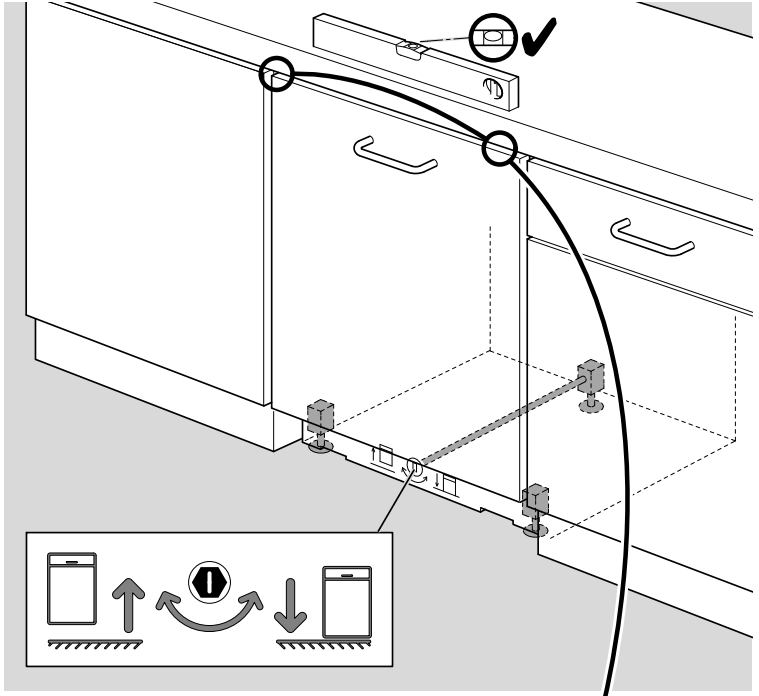
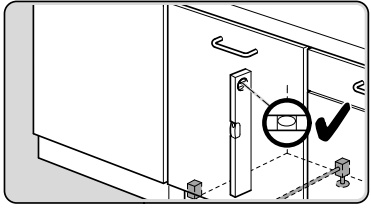
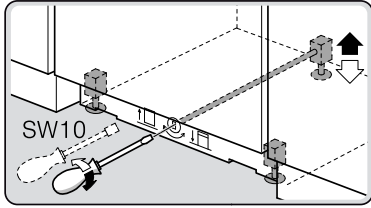
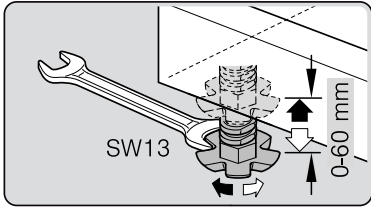

verspannen
brace
calar verticalement
Enrasar

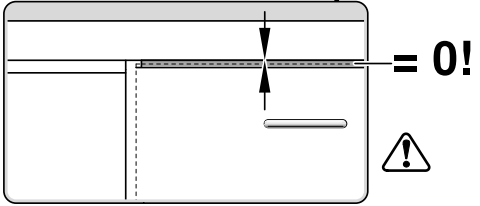

Ø4X28

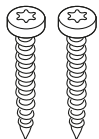

Torx
T 20

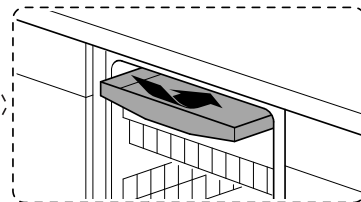
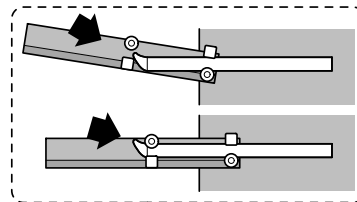
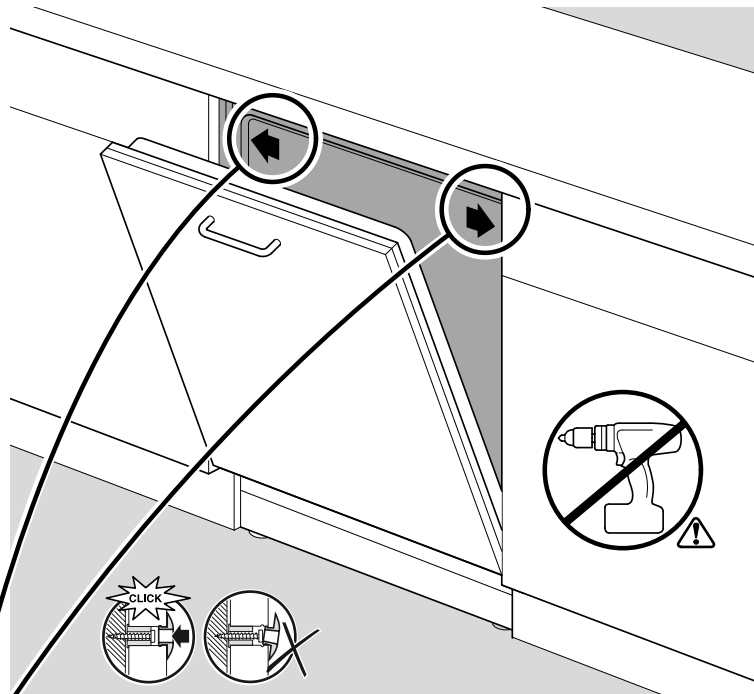
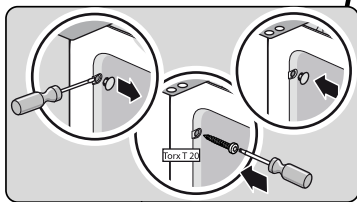
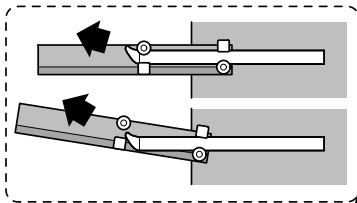
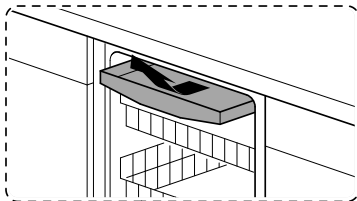
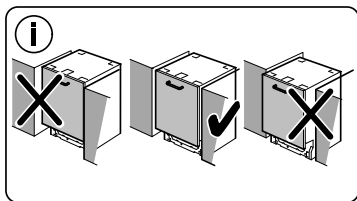

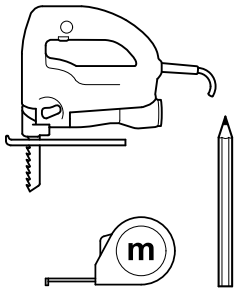
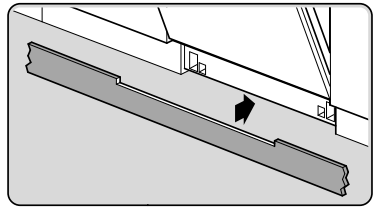
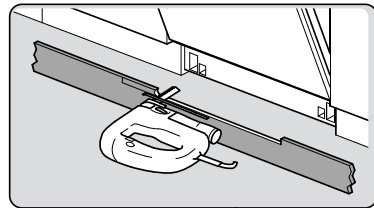
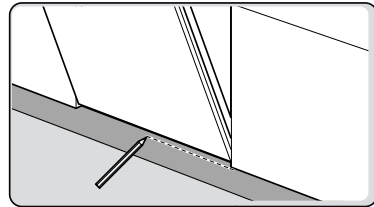
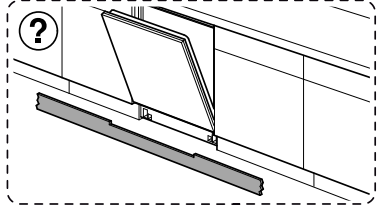
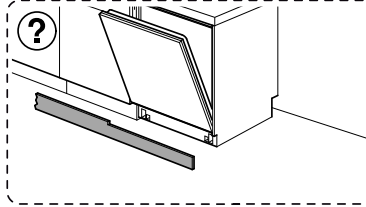
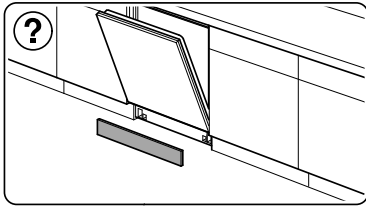

Ø4X15

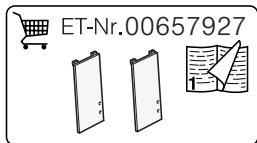
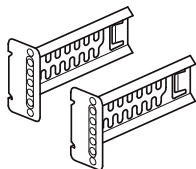

Torx
T 20

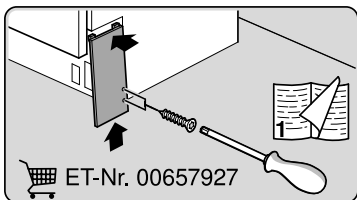
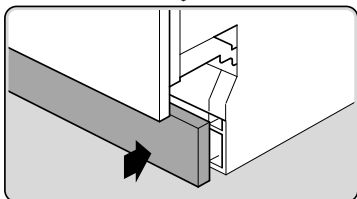
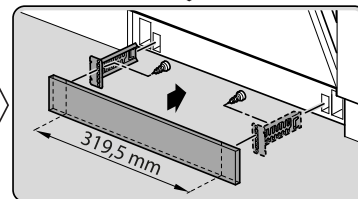
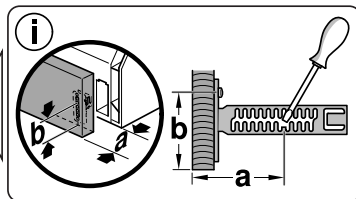
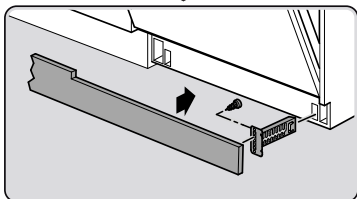
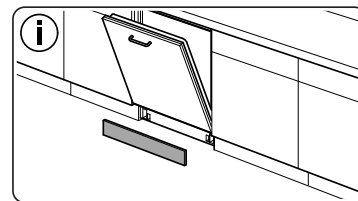
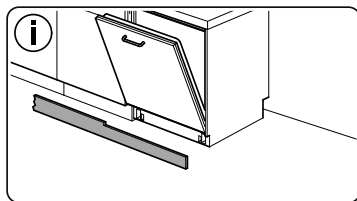
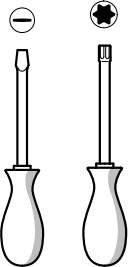

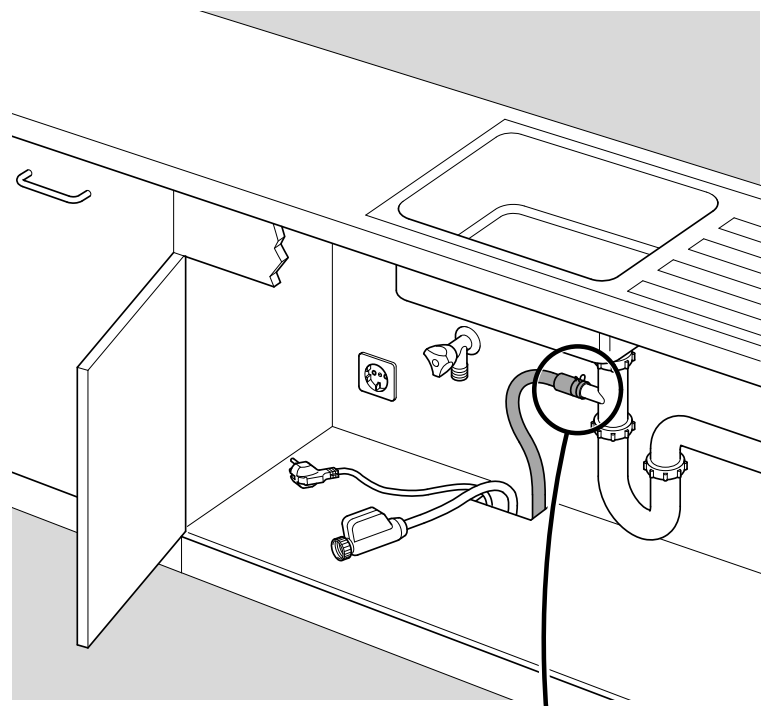
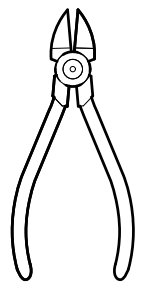
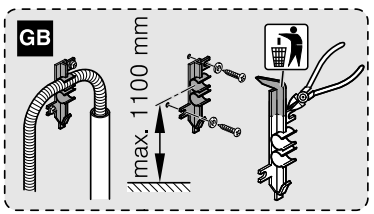
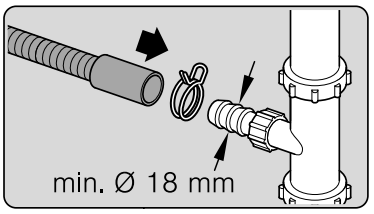
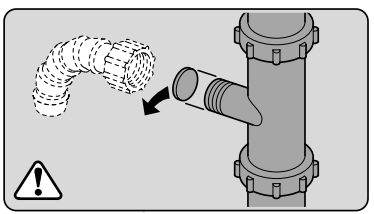
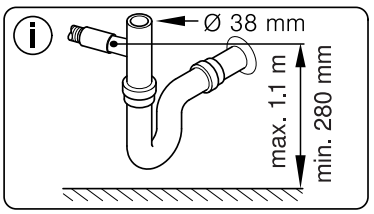

Dichtheit prüfen
Check for leaks
Verifiez l'étanchéité
Verificar la estanqueidad

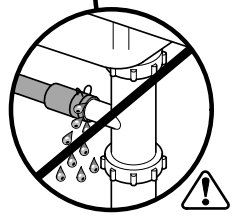

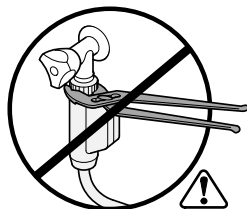
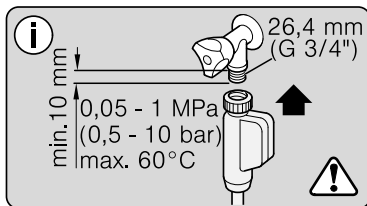

max. 10 Nm

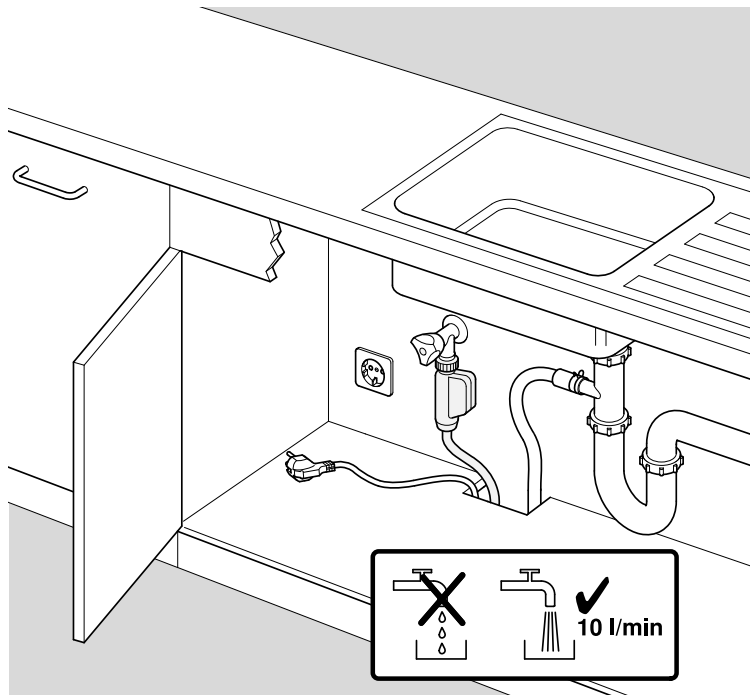

Dichtheit prüfen
Check for leaks
Verifiez l'étanchéité
Verificar la estanqueidad



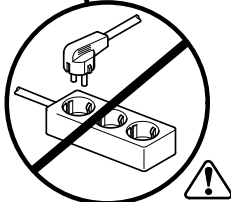
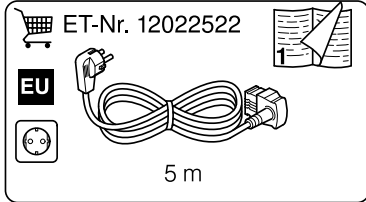
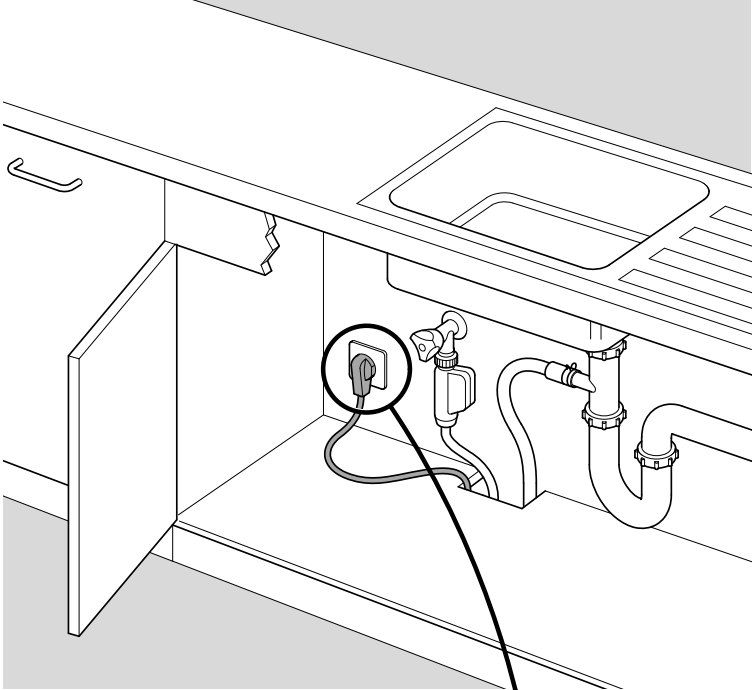
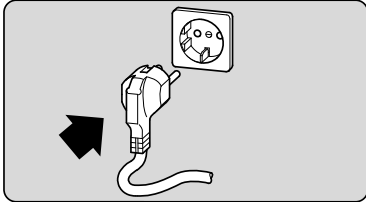



A series of horizontal lines for writing, starting from the top of the page and extending to the bottom, with a vertical margin line on the left side.



A series of horizontal lines for writing, starting from a vertical margin line on the left and extending across the page.