

9001865024 (030426) 642A_SK_86,5_Türassi

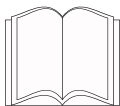

de Montageanleitung
sv Installationsanvisningar
no Installasjonsveiledning

fi Asennusohjeet
da Installationsvejledning



de über den Kundendienst erhältlich
sv går att beställa via service
no fås hos kundeservice

fi saatavissa huoltopalvelusta
da Fås hos kundeservice

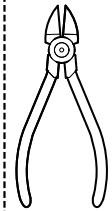
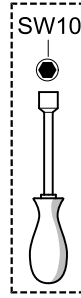
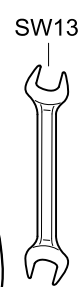
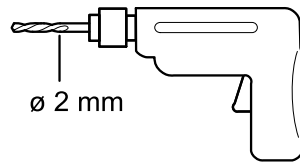
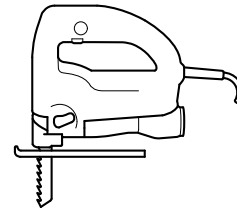
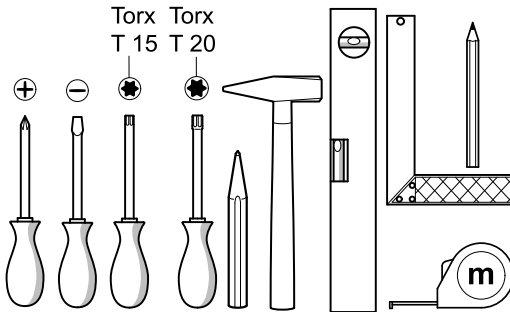
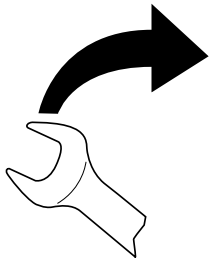
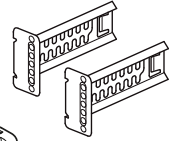
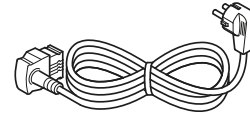
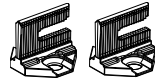
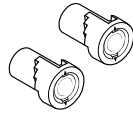
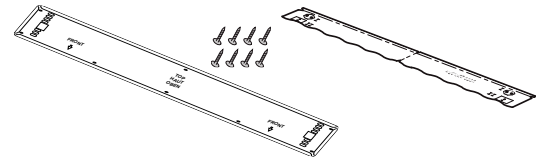
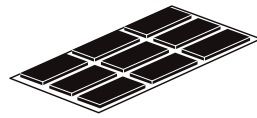
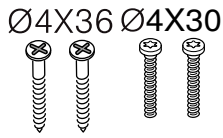
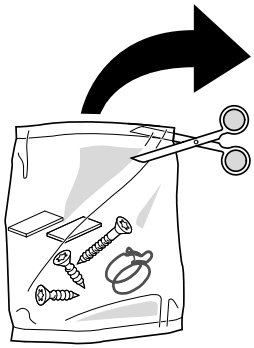

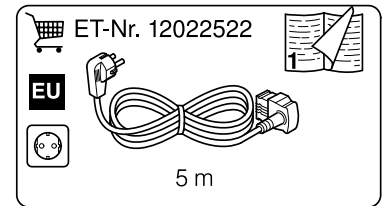
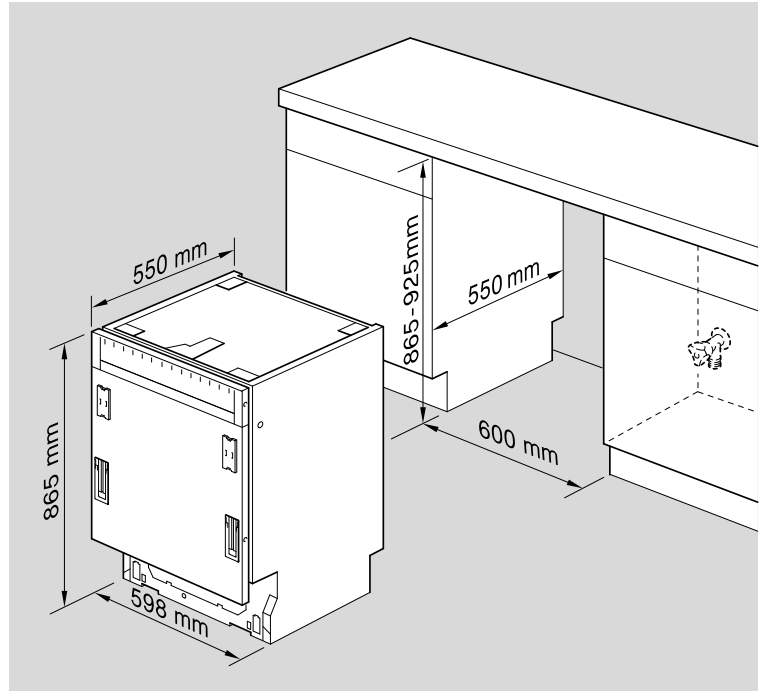
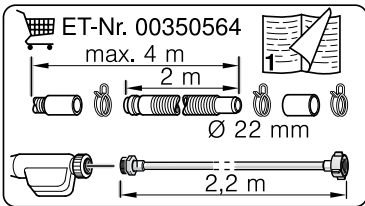
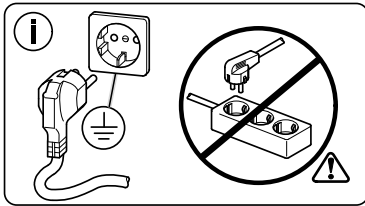
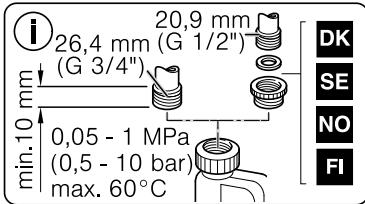
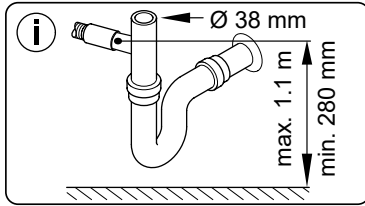

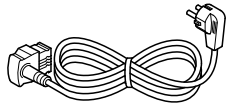

ET-Nr. 12022522

EU 5 m

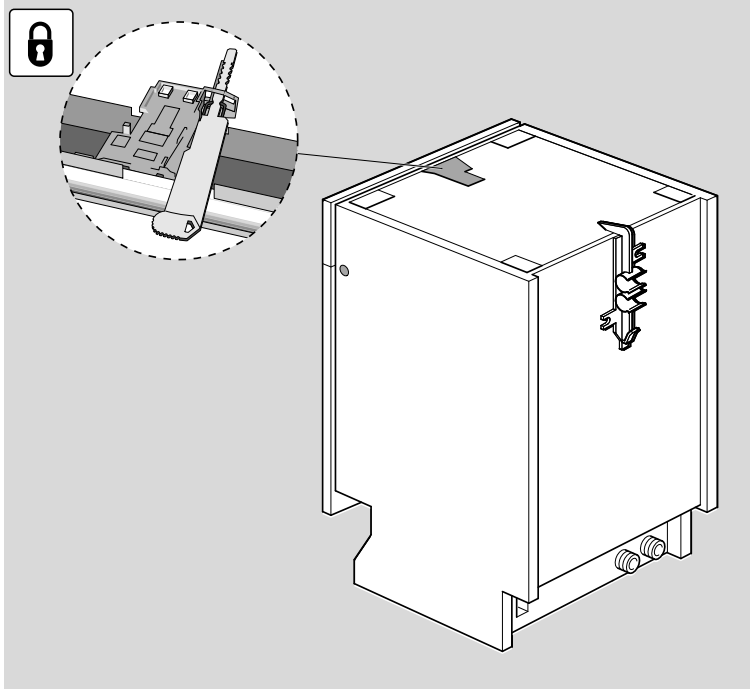
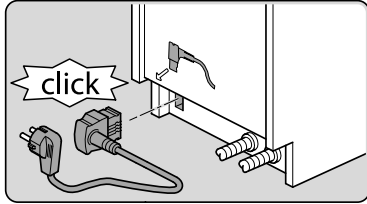
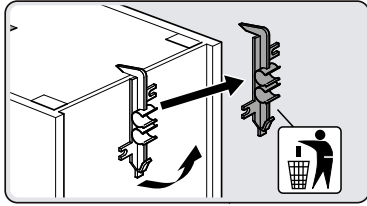

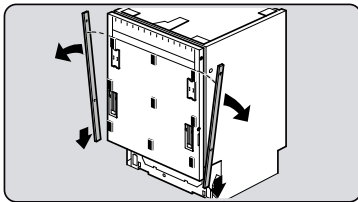
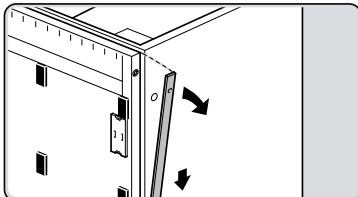
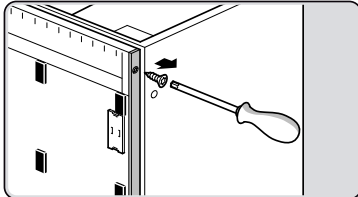
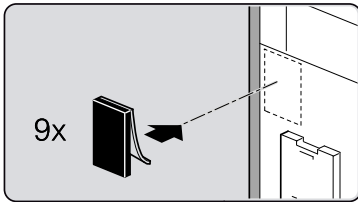
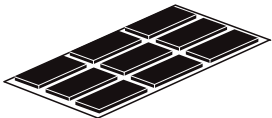

Torx
T 15

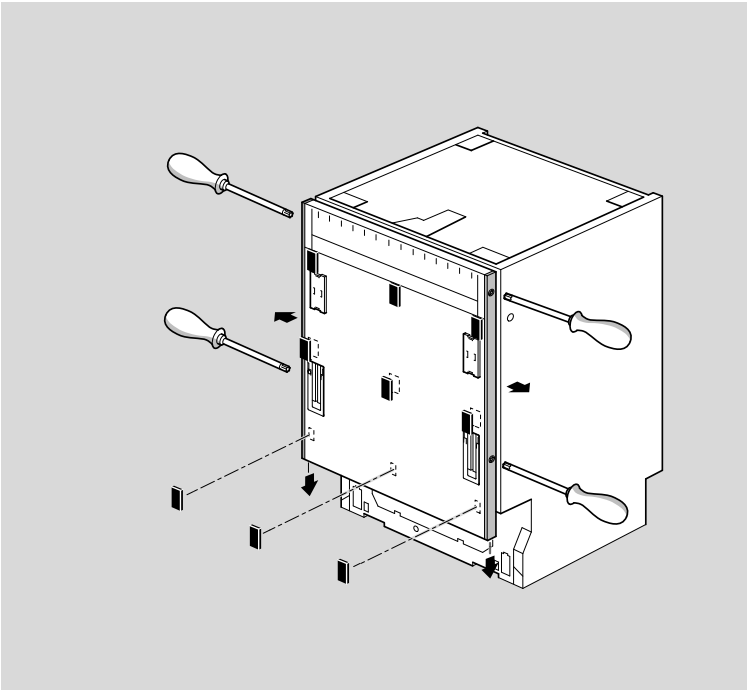

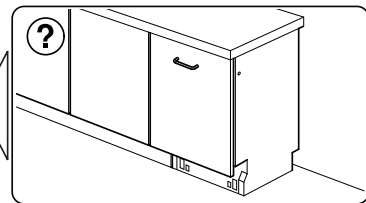
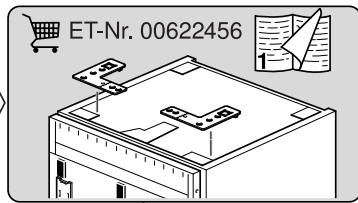
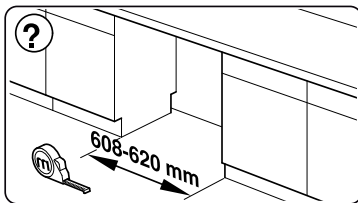
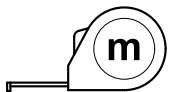
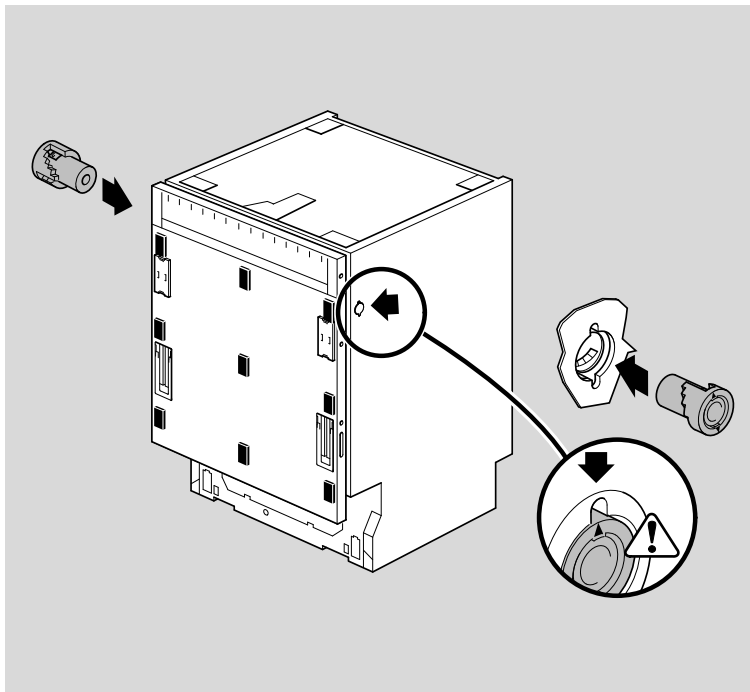
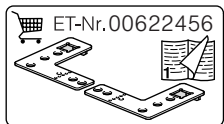
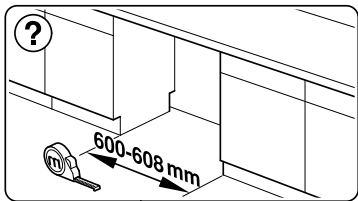
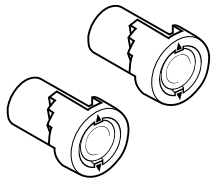

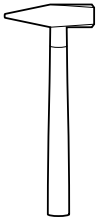
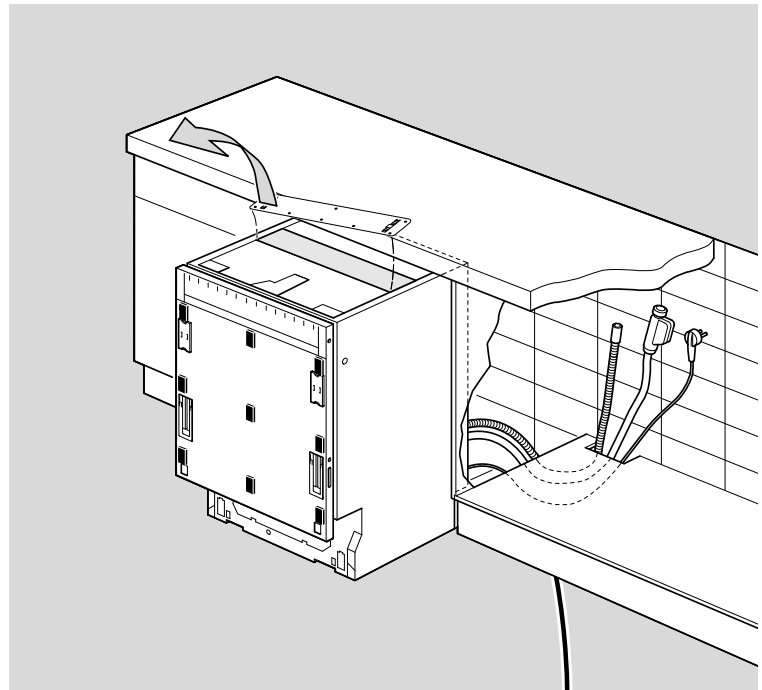
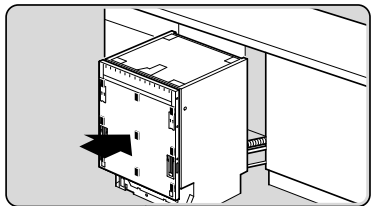
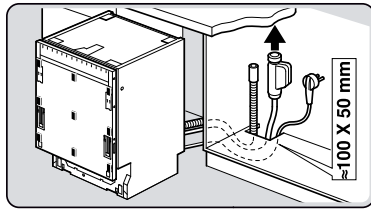
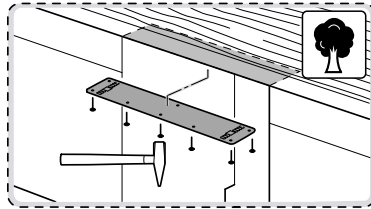
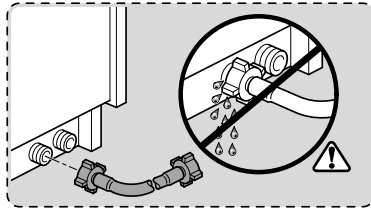
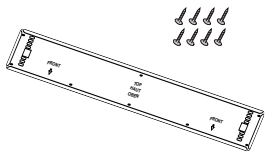

nicht einklemmen
do not pinch
ne pas coincer
No doblar

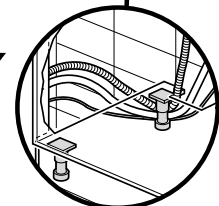

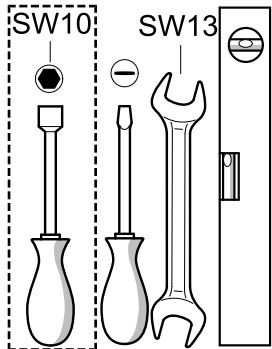
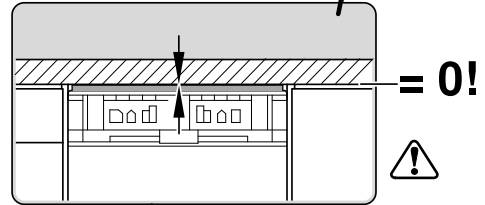
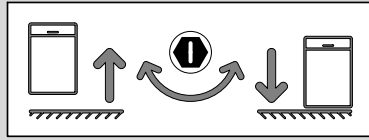
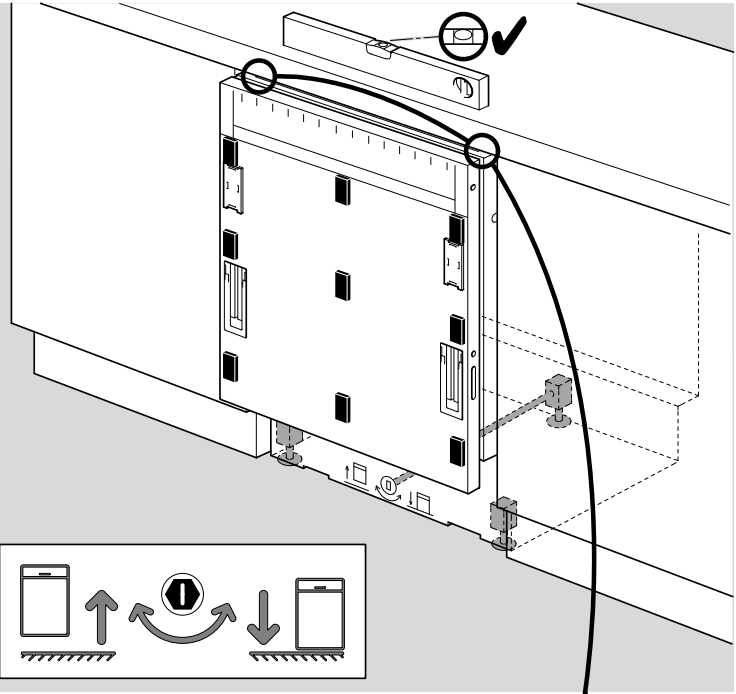
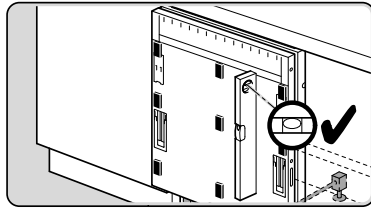
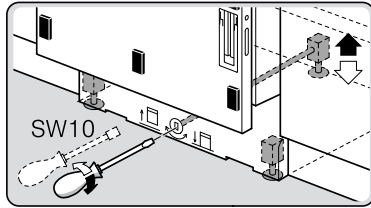
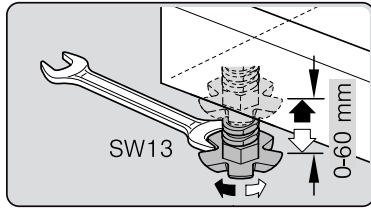

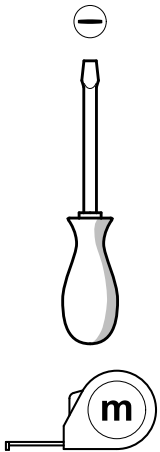
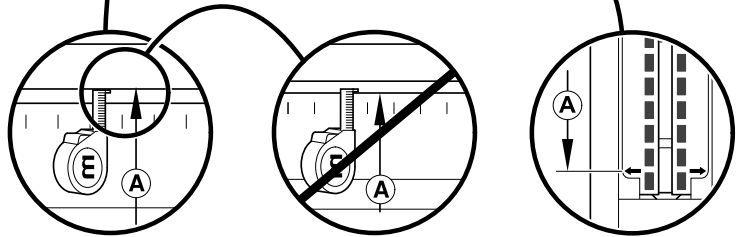
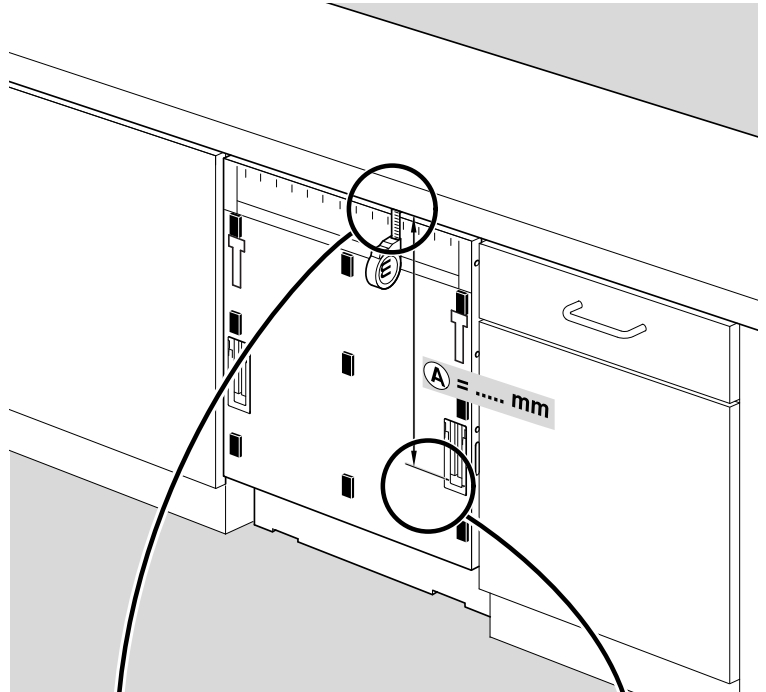
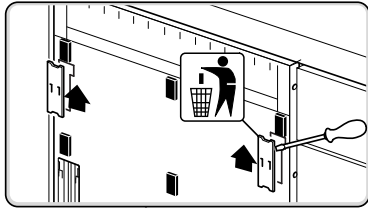

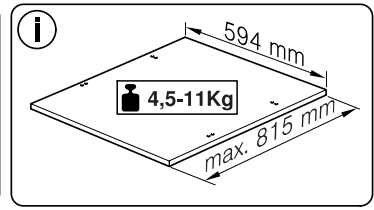
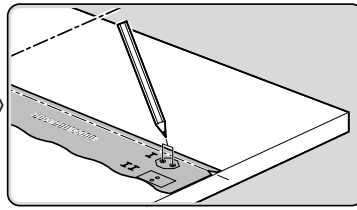
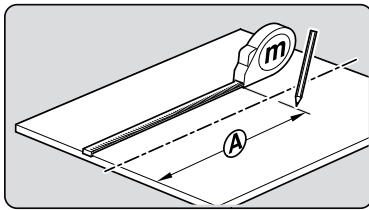
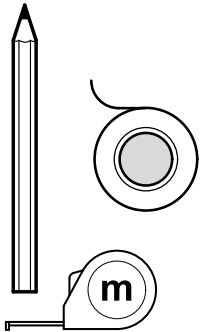
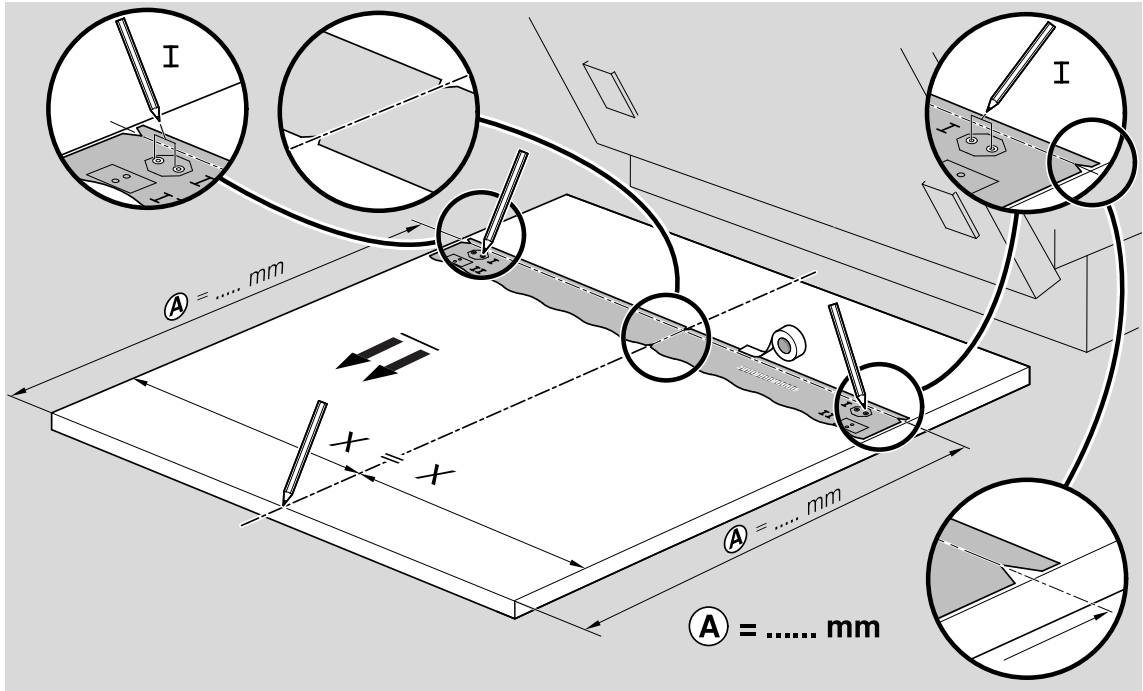
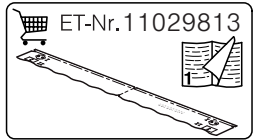
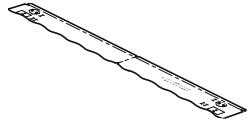

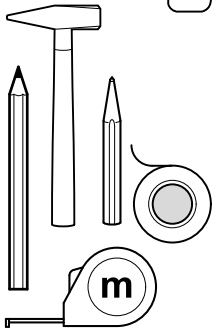
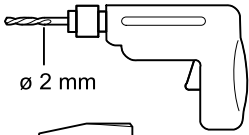
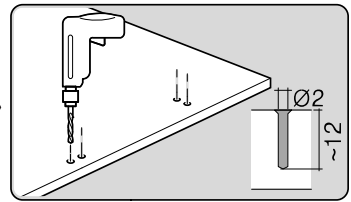
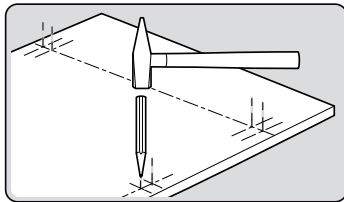
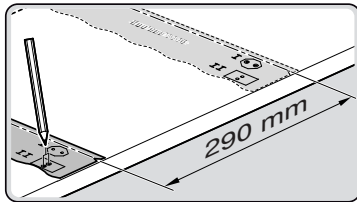
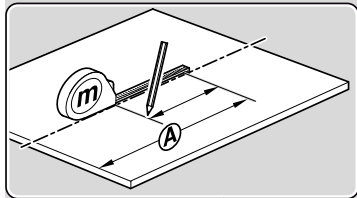
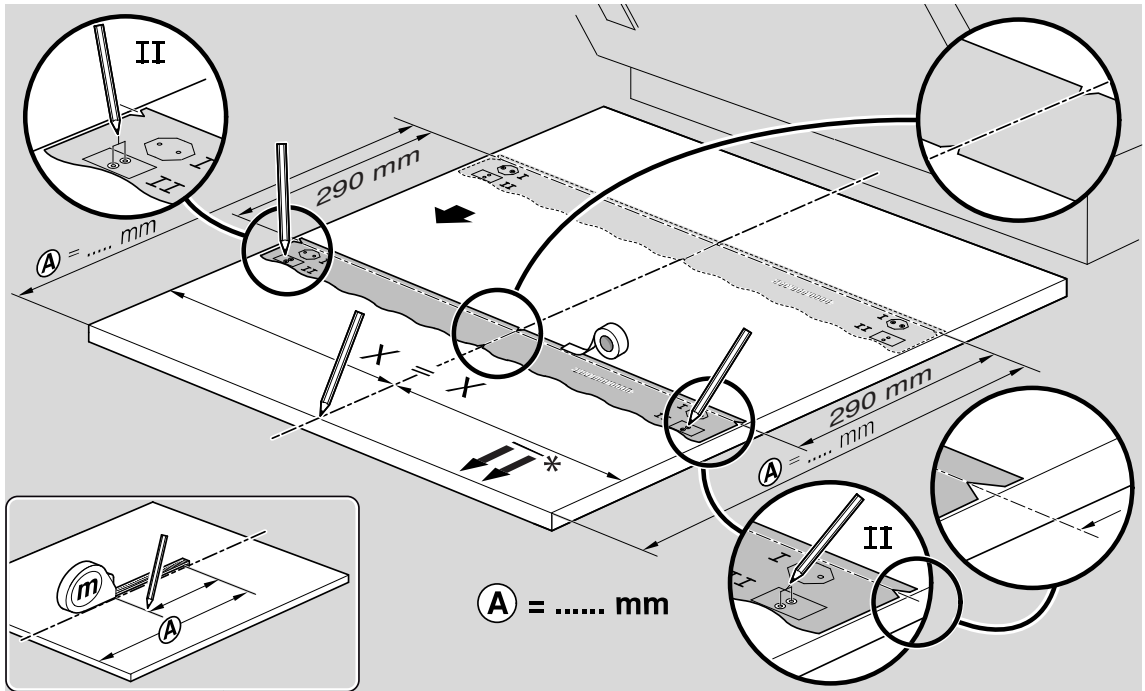

Ø4X15

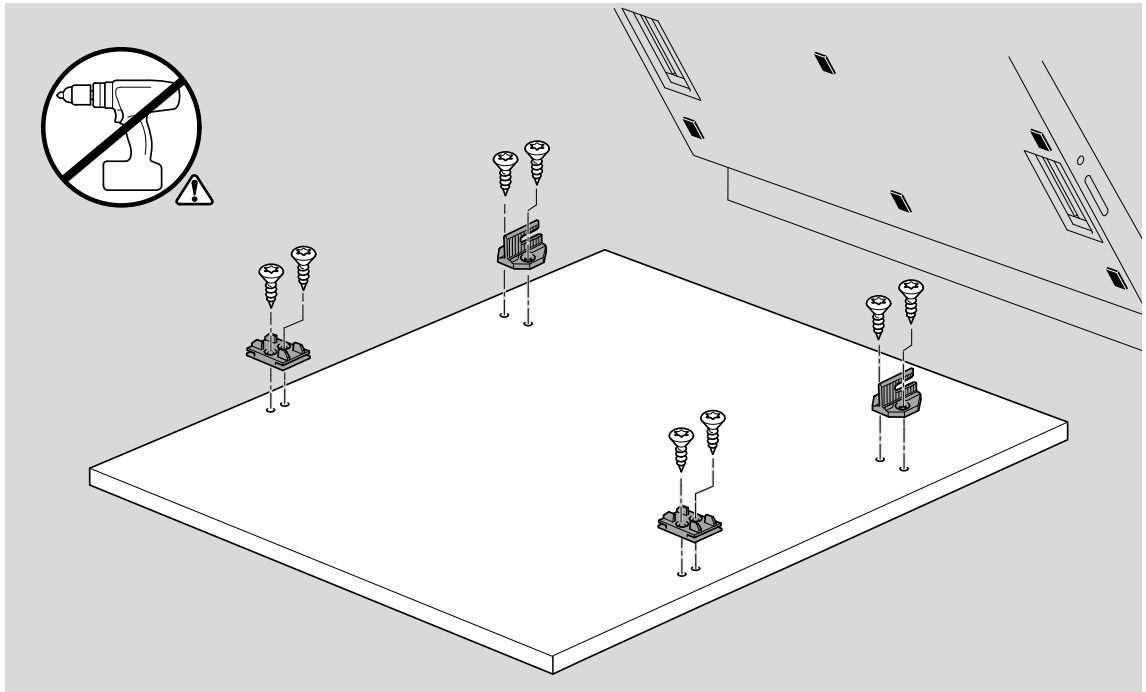
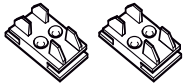
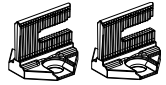

Torx
T 20

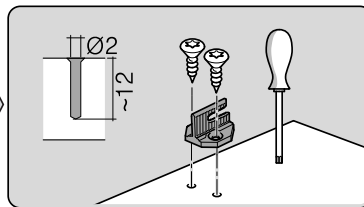
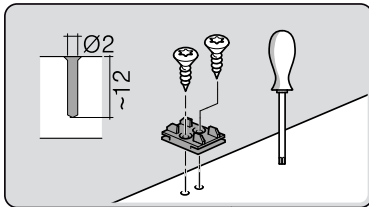
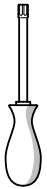

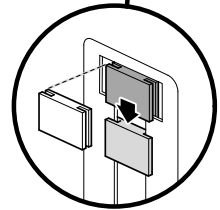
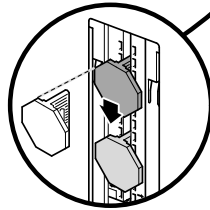
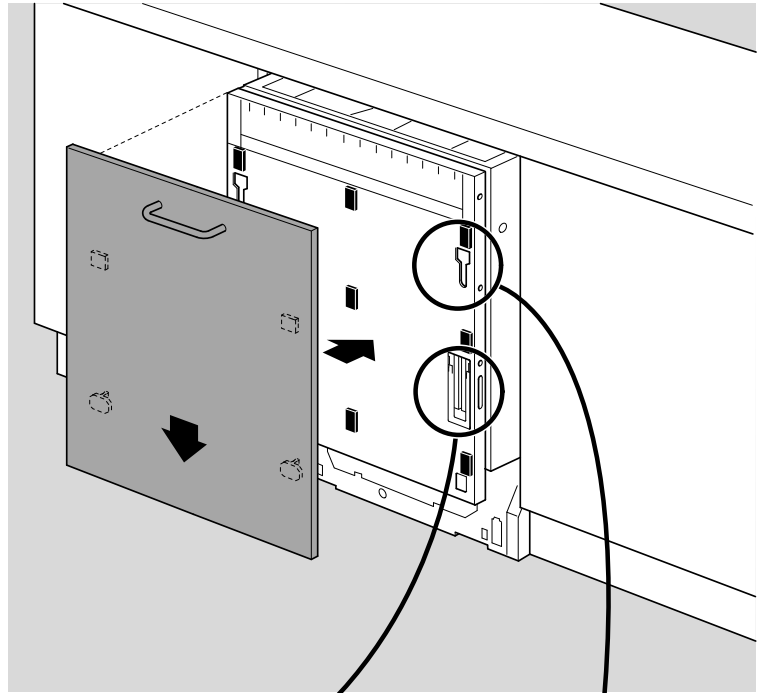
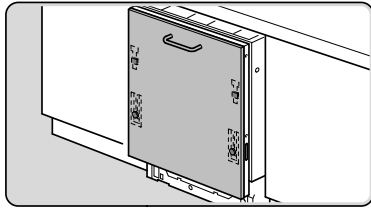
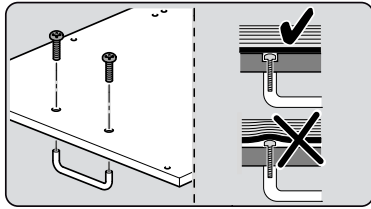

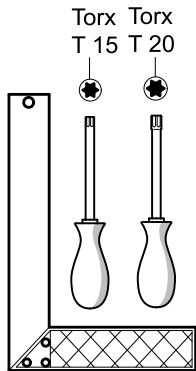
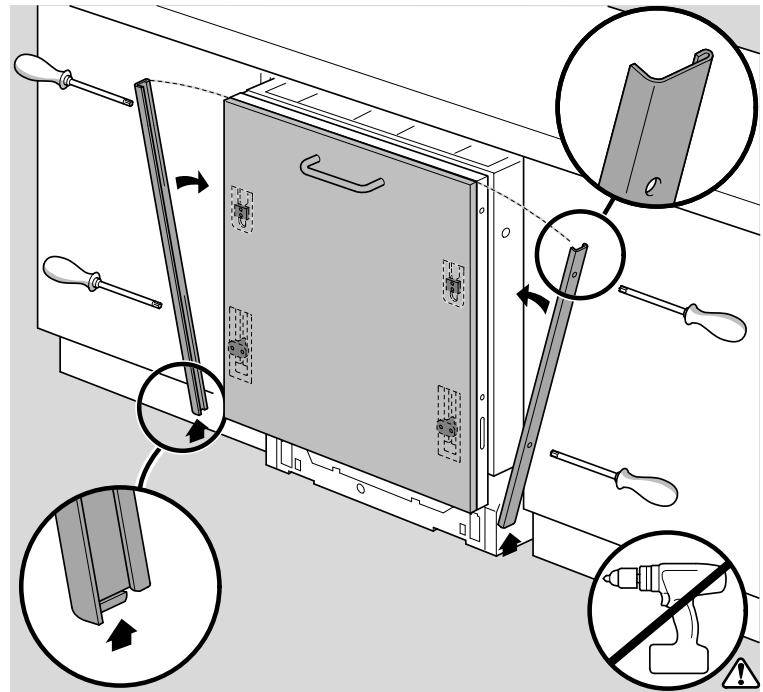
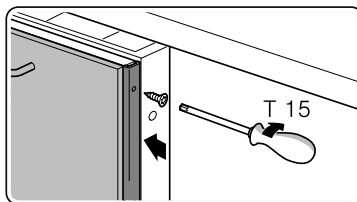
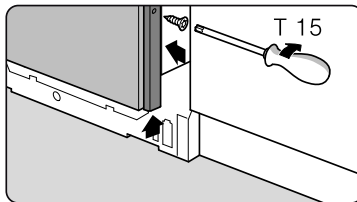
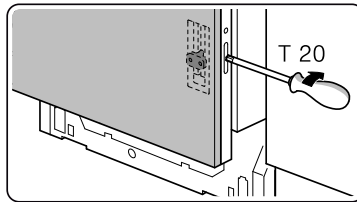
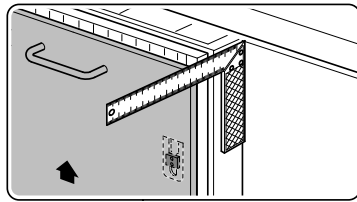

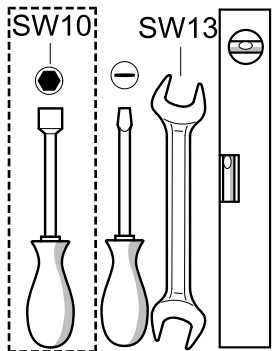
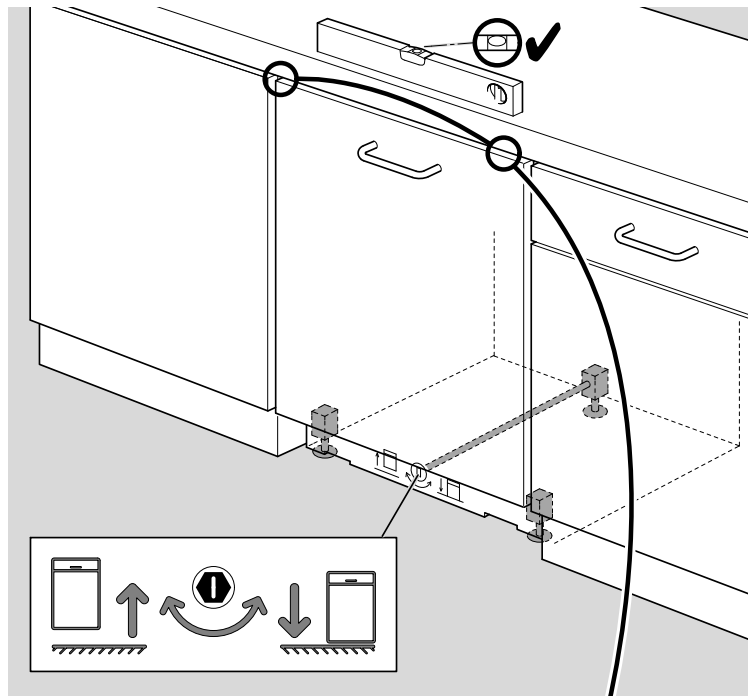
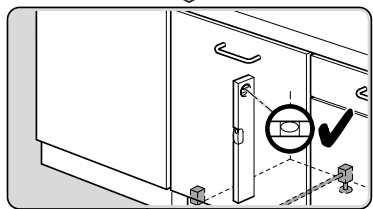
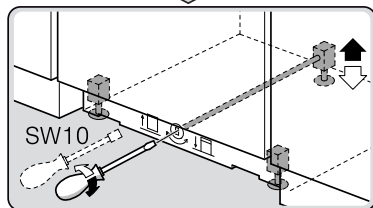
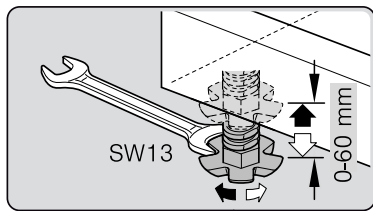

verspannen
brace
calar verticalement
Enrasar

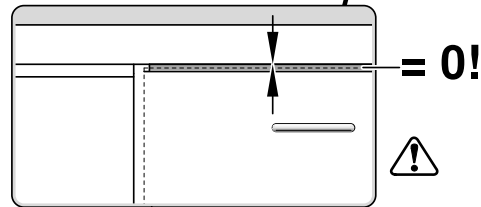

Ø4X30



Torx
T 20

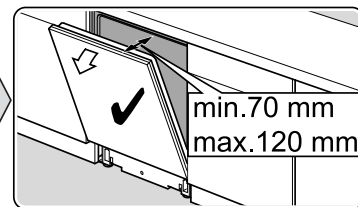
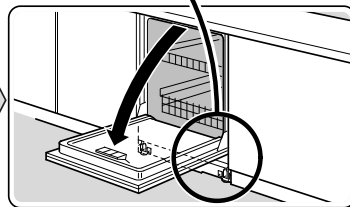
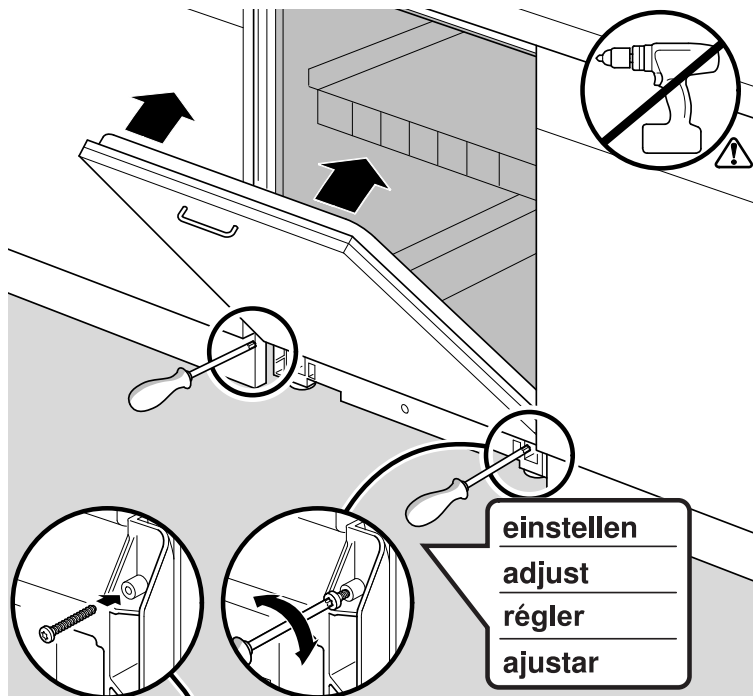
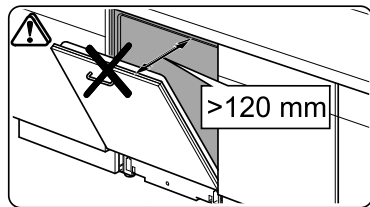
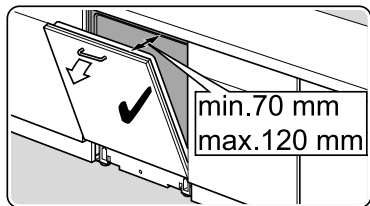

Ø4X36

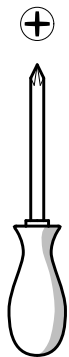
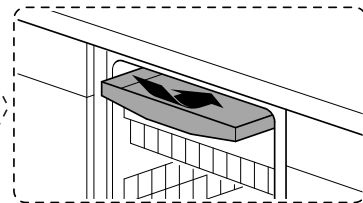
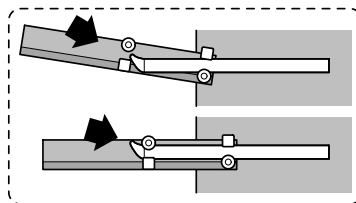
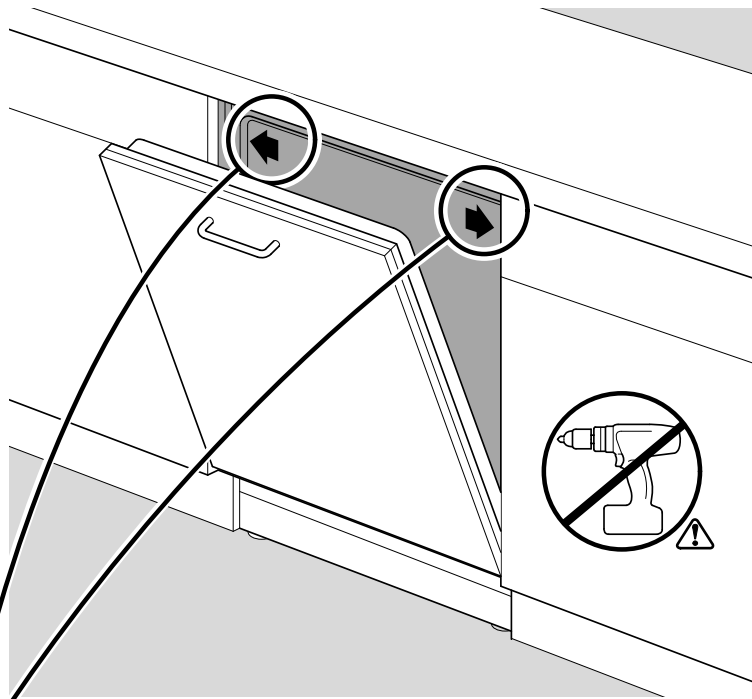
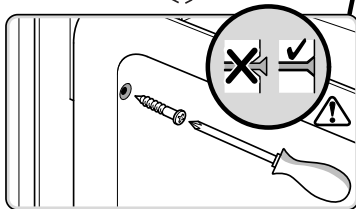
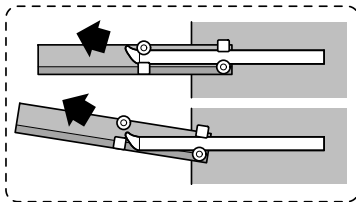
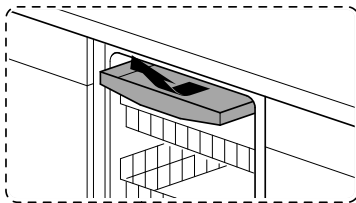
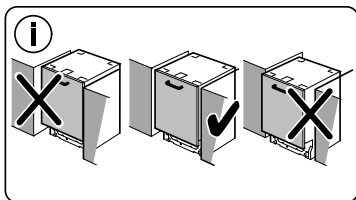
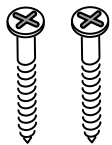

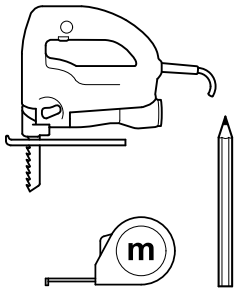
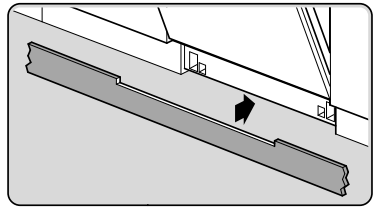
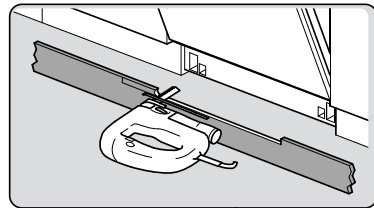
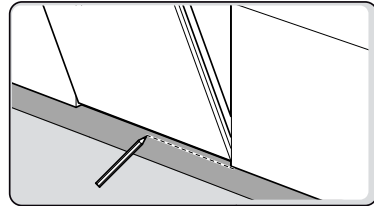
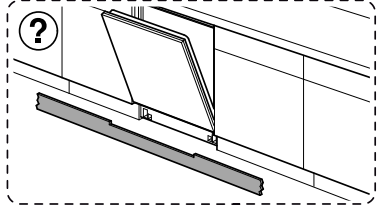
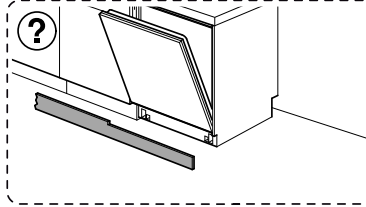
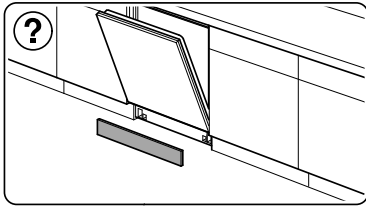

Ø4X15

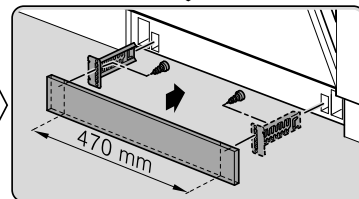
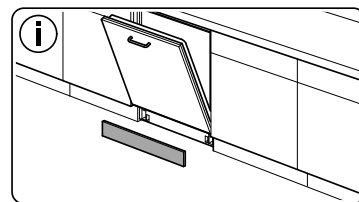
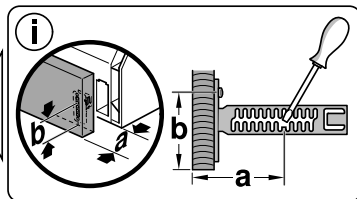
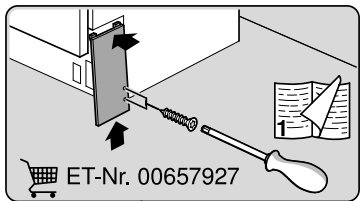
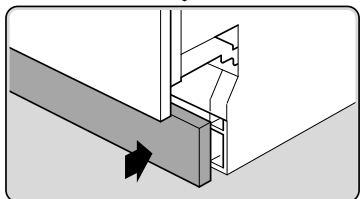
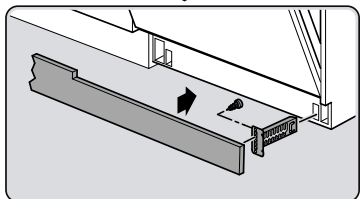
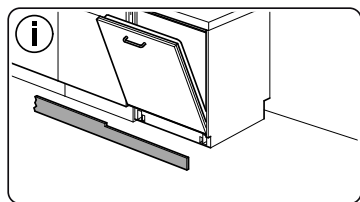
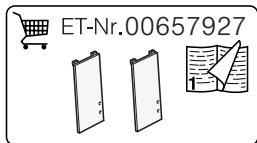
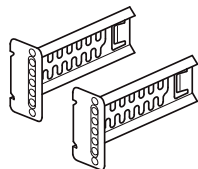

Torx
T 20

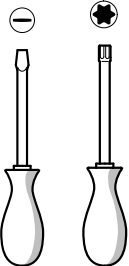

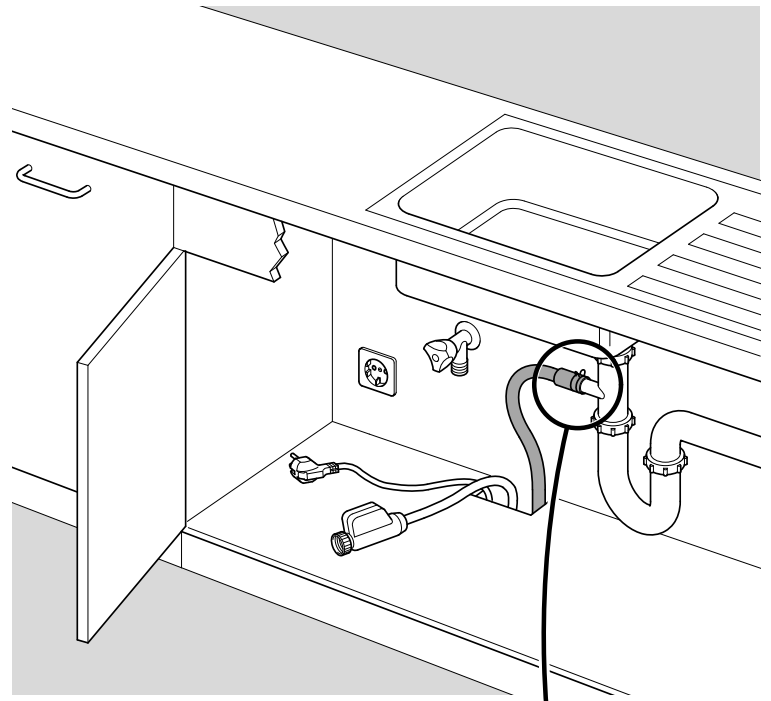
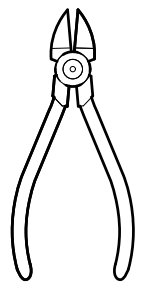
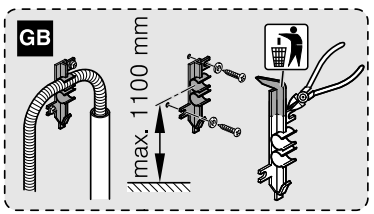
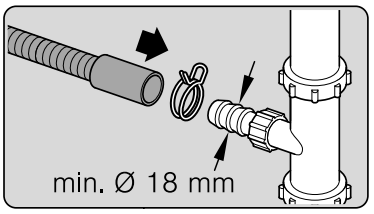
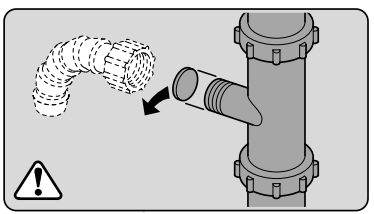
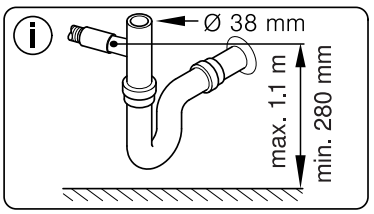

Dichtheit prüfen
Check for leaks
Verifiez l'étanchéité
Verificar la estanqueidad

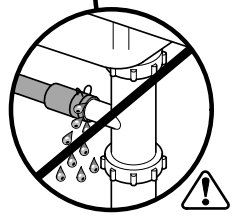

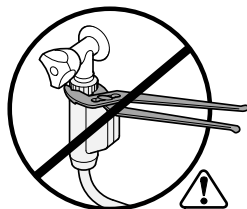
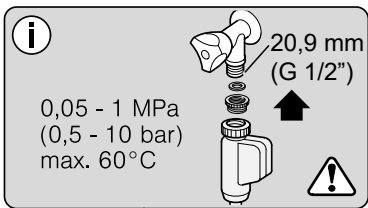
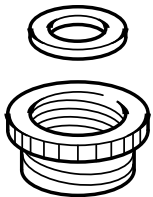

max. 10 Nm

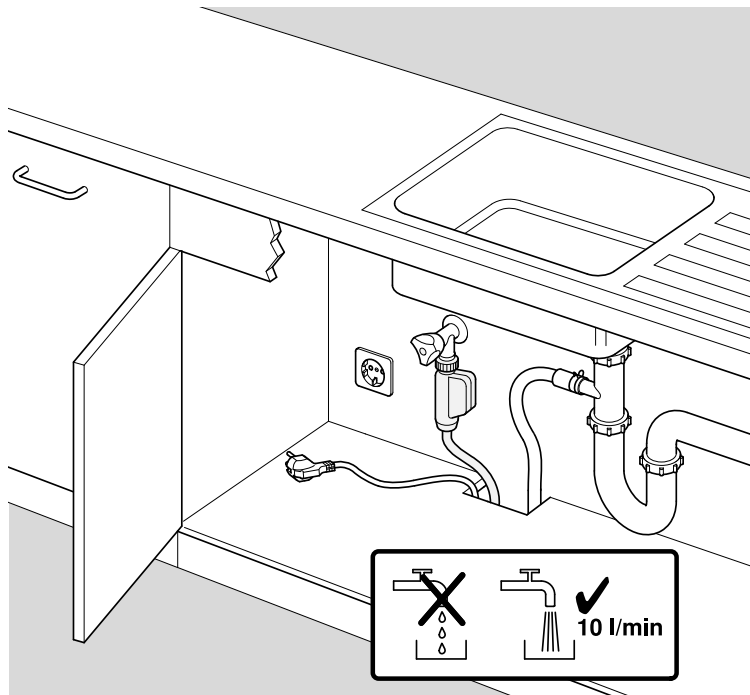

Dichtheit prüfen
Check for leaks
Verifiez l'étanchéité
Verificar la estanqueidad



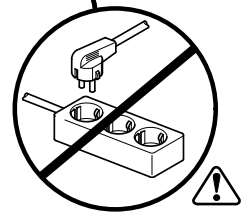
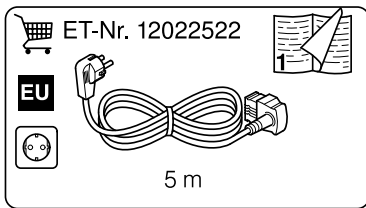
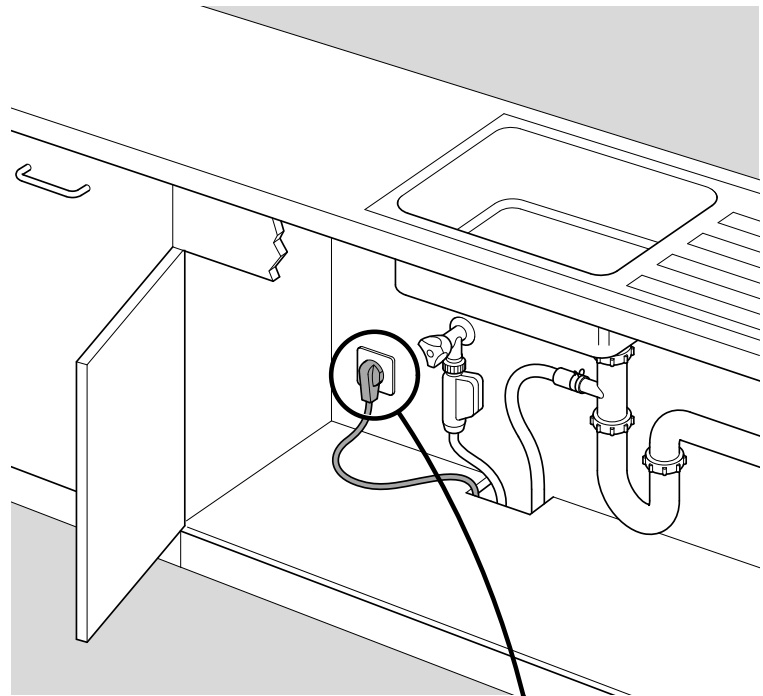
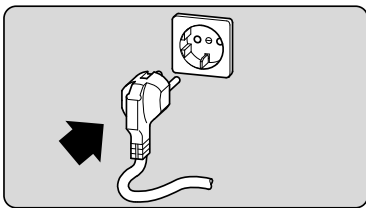



A series of horizontal lines for writing, starting from a vertical margin line on the left and extending to the right edge of the page. There are 20 horizontal lines in total, providing a ruled area for text.



A series of horizontal lines forming a writing area on the page.