



**BOSCH**



**Register** your  
new device on  
MyBosch now and  
get free benefits:  
**[bosch-home.com/  
welcome](https://www.bosch-home.com/welcome)**

# Tumble dryer

**WTM8327SZA**

**[en]** User manual and installation  
instructions

**Further information and explanations are available online:**



## Table of contents

<b>1 Safety .....</b>	<b>4</b>	<b>9 Programmes .....</b>	<b>21</b>
1.1 General information.....	4	9.1 Automatic programmes.....	21
1.2 Intended use.....	4	9.2 Timed programmes.....	22
1.3 Restriction on user group.....	4	<b>10 Accessories.....</b>	<b>24</b>
1.4 Safe installation .....	5	<b>11 Laundry.....</b>	<b>24</b>
1.5 Safe use .....	7	11.1 Preparing the laundry.....	24
1.6 Safe cleaning and maintenance.....	9	<b>12 Basic operation .....</b>	<b>25</b>
<b>2 Preventing material damage ....</b>	<b>11</b>	12.1 Switching on the appliance... ..	25
<b>3 Environmental protection and saving energy.....</b>	<b>11</b>	12.2 Setting a programme .....	25
3.1 Disposing of packaging .....	11	12.3 Adjusting the programme settings .....	25
3.2 Saving energy.....	11	12.4 Loading laundry.....	25
3.3 Energy saving mode .....	12	12.5 Starting the programme .....	25
<b>4 Installation and connection.....</b>	<b>12</b>	12.6 Changing the activated programme end time .....	25
4.1 Unpacking the appliance .....	12	12.7 Adding laundry .....	26
4.2 Scope of delivery.....	12	12.8 Cancelling the programme... ..	26
4.3 Requirements for the installation location .....	12	12.9 Unloading the laundry .....	26
4.4 Aligning the appliance.....	13	12.10 Switching off the appliance.....	26
4.5 Connecting the appliance to the electricity supply.....	13	12.11 Fluff filter.....	26
<b>5 Familiarising yourself with your appliance.....</b>	<b>14</b>	12.12 Condensation container .....	28
5.1 Appliance .....	14	<b>13 Childproof lock.....</b>	<b>28</b>
5.2 Control panel.....	15	13.1 Activating the childproof lock.....	28
<b>6 Display .....</b>	<b>16</b>	13.2 Deactivating the childproof lock.....	29
<b>7 Buttons .....</b>	<b>18</b>	<b>14 Basic settings.....</b>	<b>30</b>
<b>8 Dryness level.....</b>	<b>20</b>	14.1 Overview of the basic settings.....	30
8.1 Changing the dryness level.....	20	14.2 Changing the basic settings.....	31
8.2 Adjusting the dryness level .....	20		

<b>15 Cleaning and servicing .....</b>	<b>31</b>
15.1 Tips on cleaning and care ....	31
15.2 Base unit .....	32
15.3 Moisture sensor.....	34
<b>16 Troubleshooting.....</b>	<b>35</b>
<b>17 Transportation, storage and disposal .....</b>	<b>39</b>
17.1 Preparing the appliance for transportation .....	39
17.2 Disposing of old appliance ...	39
<b>18 Customer Service.....</b>	<b>40</b>
18.1 Product number (E-Nr.) and production number (FD).....	40
<b>19 Consumption values.....</b>	<b>41</b>
<b>20 Technical data .....</b>	<b>42</b>



# 1 Safety

---

Observe the following safety instructions.

## 1.1 General information



- Read this instruction manual carefully.
- Keep the instruction manual and the product information safe for future reference or for the next owner.
- Do not connect the appliance if it has been damaged in transit.

## 1.2 Intended use

Only use this appliance:

- For drying and freshening up fabrics that are washed with water and suitable for dryers.
- In private households and in enclosed spaces in a domestic environment.
- Up to an altitude of max. 4000 m above sea level.

## 1.3 Restriction on user group

This appliance may be used by children aged 8 or over and by people who have reduced physical, sensory or mental abilities or inadequate experience and/or knowledge, provided that they are supervised or have been instructed on how to use the appliance safely and have understood the resulting dangers.

Do not let children play with the appliance.

Cleaning and user maintenance must not be performed by children unless they are being supervised.

Keep children under the age of 3 years and pets away from the appliance.

## 1.4 Safe installation

### **WARNING – Risk of electric shock!**

Incorrect installation is dangerous.

- ▶ Connect and operate the appliance only in accordance with the specifications on the rating plate.
- ▶ Connect the appliance to a power supply with alternating current only via a properly installed socket with earthing.
- ▶ The protective conductor system of the domestic electrical installation must be properly installed. The installation must have a sufficiently large cross section.
- ▶ When using a residual current circuit breaker, only use a type with the  mark.
- ▶ Never equip the appliance with an external switching device, e.g. a timer or remote control.
- ▶ Never connect the appliance to a circuit that is regularly switched on and off by the energy supplier.
- ▶ When the appliance is installed, the mains plug of the power cord must be freely accessible. If free access is not possible, an all-pole isolating switch must be installed in the permanent electrical installation according to the installation regulations.
- ▶ When installing the appliance, check that the power cable is not trapped or damaged.

If the insulation of the power cord is damaged, this is dangerous.

- ▶ Never let the power cord come into contact with hot appliance parts or heat sources.
- ▶ Never let the power cord come into contact with sharp points or edges.
- ▶ Never kink, crush or modify the power cord.

### **WARNING – Risk of fire!**

It is dangerous to use an extended power cord and non-approved adapters.

- ▶ Do not use extension cables or multiple socket strips.
- ▶ Only use adapters and power cords approved by the manufacturer.

- ▶ If the power cord is too short and a longer one is not available, please contact an electrician to have the domestic installation adapted.

### **⚠ WARNING – Risk of injury!**

The high weight of the appliance may result in injury when lifted.

- ▶ Do not lift the appliance on your own.

If this appliance is not correctly installed in a washer-dryer stack, the installed appliance may fall.

- ▶ Only stack the dryer on a washing machine using the connection kit from the dryer manufacturer  
→ "Accessories", Page 24. No other installation method is permitted.
- ▶ Do not install the appliance in a washer-dryer stack if the dryer manufacturer does not offer a suitable connection kit.
- ▶ Do not install appliances from different manufacturers and with varying depths and widths in a washer-dryer stack.
- ▶ Do not install a washer-dryer stack on a platform; the appliances may tip over.

### **⚠ WARNING – Risk of suffocation!**

Children may put packaging material over their heads or wrap themselves up in it and suffocate.

- ▶ Keep packaging material away from children.
- ▶ Do not let children play with packaging material.

### **⚠ CAUTION – Risk of injury!**

The appliance may vibrate or move when in use.

- ▶ Place the appliance on a clean, even, solid surface.
- ▶ Align the appliance using the appliance feet and a spirit level.

If hoses and power cords have been laid incorrectly, this causes a tripping hazard.

- ▶ Lay hoses and power cords in such a way that there is no risk of tripping.

If the appliance is moved by holding onto protruding components, such as the appliance door, the parts may break off.

- ▶ Do not move the appliance by holding onto protruding parts.

**⚠ CAUTION – Risk of cutting!**

Touching sharp edges on the appliance may lead to cuts.

- ▶ Do not touch the sharp edges on the appliance.
- ▶ Wear protective gloves when installing and transporting the appliance.

**1.5 Safe use****⚠ WARNING – Risk of electric shock!**

If the appliance or the power cord is damaged, this is dangerous.

- ▶ Never operate a damaged appliance.
- ▶ Never pull on the power cord to unplug the appliance. Always unplug the appliance at the mains.
- ▶ If the appliance or the power cord is damaged, immediately unplug the power cord or switch off the fuse in the fuse box.
- ▶ Call customer services. → *Page 40*

An ingress of moisture can cause an electric shock.

- ▶ Only use the appliance in enclosed spaces.
- ▶ Never expose the appliance to intense heat or humidity.
- ▶ Do not use steam- or high-pressure cleaners, hoses or sprays to clean the appliance.

**⚠ WARNING – Risk of harm to health!**

Children can lock themselves in the appliance, thereby putting their lives at risk.

- ▶ Do not install the appliance behind a door as this may obstruct the appliance door or prevent it from opening.
- ▶ With redundant appliances, unplug the power cord. Then cut through the cord and damage the lock on the appliance door beyond repair so that the appliance door will no longer close.

**⚠ WARNING – Risk of suffocation!**

Children may breathe in or swallow small parts, causing them to suffocate.

- ▶ Keep small parts away from children.
- ▶ Do not let children play with small parts.

**⚠ WARNING – Risk of explosion!**

If there is coal dust or flour in the air around the appliance, this may cause an explosion.

- ▶ Keep the area around the appliance clean during operation.

**⚠ WARNING – Risk of poisoning!**

Condensation water from this appliance is not suitable for drinking and may be contaminated with fluff.

- ▶ Do not drink or reuse the condensation water from the appliance.

Detergents and care products may result in poisoning if consumed.

- ▶ If accidentally swallowed, seek medical advice.
- ▶ Keep detergents and care products out of the reach of children.

**⚠ WARNING – Risk of explosion!**

If there is any residual material left in the fluff filter, this may ignite during the drying process.

- ▶ Clean the fluff filter regularly.

Highly flammable objects such as lighters or matches may ignite during the drying process.

- ▶ Remove all highly flammable objects from any pockets in your laundry before the drying process.

Unwashed laundry that has come into contact with solvents, oil, wax, wax remover, paint, grease or stain remover may ignite when drying is in progress.

- ▶ Do not place laundry in this appliance to be dried if the laundry has not been washed first.
- ▶ Rinse the laundry thoroughly with warm water and detergent before drying it in the machine.
- ▶ Do not use the appliance if industrial chemicals have been used to clean the laundry beforehand.

**⚠ WARNING – Risk of fire!**

If drying is interrupted early, the laundry is not cooled sufficiently and may ignite.

- ▶ Do not interrupt the drying programme early.



- ▶ If drying is interrupted early, remove the laundry immediately and spread it out.

### **⚠ CAUTION – Risk of injury!**

The covering plate may break if you stand on or climb onto the appliance.

- ▶ Do not stand on or climb onto the appliance.

The appliance may tip over if you sit on or lean against the open door.

- ▶ Do not sit on or lean against the appliance door.
- ▶ Do not place any objects on the appliance door.

Reaching into the drum while it is still turning may cause hand injuries.

- ▶ Wait for the drum to come to a complete stop before reaching inside.

### **⚠ CAUTION – Risk of burns!**

The rear panel of the appliance becomes hot during operation.

- ▶ Do not touch the rear panel of the appliance when it is hot.
- ▶ Keep children away from the rear panel of the appliance when it is hot.
- ▶ Position the appliance with the rear panel close against a wall.

## **1.6 Safe cleaning and maintenance**

### **⚠ WARNING – Risk of electric shock!**

Incorrect repairs are dangerous.

- ▶ Repairs to the appliance should only be carried out by trained specialist staff.
- ▶ Only use genuine spare parts when repairing the appliance.
- ▶ If the power cord of this appliance is damaged, it must be replaced by the manufacturer, the manufacturer's Customer Service or a similarly qualified person in order to prevent any risk.

An ingress of moisture can cause an electric shock.

- ▶ Do not use steam- or high-pressure cleaners, hoses or sprays to clean the appliance.

** WARNING – Risk of injury!**

The use of non-original spare parts and non-original accessories is dangerous.

- ▶ Only use the manufacturer's original spare parts and original accessories.

** WARNING – Risk of poisoning!**

Poisonous fumes may be given off if you use cleaning agents that contain solvents.

- ▶ Do not use cleaning agents that contain solvents.

---

## 2 Preventing material damage

### ATTENTION!

The functionality of the appliance may be impaired if you use the wrong quantity of fabric softener, detergent, care product or cleaning agent.

- ▶ Follow the dosage recommendations from the manufacturer.

Exceeding the maximum load capacity impairs the function of the appliance.

- ▶ Observe the maximum load capacity for each programme and do not exceed it.

→ "Programmes", Page 21

The function of the appliance may be impaired if the appliance overheats.

- ▶ Keep the ventilation opening on the appliance clear during operation.
- ▶ Make sure that the area is adequately ventilated.

Light objects such as hair and fluff may be sucked in from the ventilation opening on the appliance during operation and impair the function of the appliance.

- ▶ Keep the area around the appliance clean during operation.
- ▶ Keep light objects away from the appliance.

Foam and foam rubber may deform or melt during the drying process.

- ▶ Do not dry laundry that contains foam or foam rubber.

Unsuitable cleaning products may damage the surfaces of the appliance.

- ▶ Do not use harsh or abrasive detergents.
- ▶ Do not use cleaning products with a high alcohol content.
- ▶ Do not use hard scouring pads or cleaning sponges.

- ▶ Clean the appliance with nothing but water and a soft, damp cloth.
- ▶ Remove all detergent residue, spray residue or other residues immediately if they come into contact with the appliance.

---

## 3 Environmental protection and saving energy

### 3.1 Disposing of packaging

The packaging materials are environmentally compatible and can be recycled.

- ▶ Sort the individual components by type and dispose of them separately.

### 3.2 Saving energy

If you follow these instructions, your appliance will use less power.

Operate the appliance in a well-ventilated room and keep the ventilation opening on the appliance clear.

- ✓ If air exchange is impeded, this extends the programme duration and increases energy consumption.

Spin the laundry in the washing machine before drying.

- ✓ Damper laundry extends the programme duration and increases energy consumption.

Observe the programme's maximum load capacity.

→ "Programmes", Page 21

- ✓ If the maximum load is exceeded, this extends the programme duration and increases energy consumption.

## en Installation and connection

After drying, clean the fluff filter  
→ Page 26.

- ✓ If the fluff filter is dirty, this reduces the air flow in the appliance, extends the programme duration and increases energy consumption.

Regularly clean the base unit  
→ Page 32.

- ✓ If the heat exchanger is dirty, this extends the programme duration and increases energy consumption.

### 3.3 Energy saving mode

If you do not use the appliance for an extended period, it automatically switches to energy-saving mode. All displays go out and  flashes. Energy-saving mode ends when you use the appliance again.

---

## 4 Installation and connection

### 4.1 Unpacking the appliance

#### ATTENTION!

Objects remaining in the drum that are not designed for operation with the appliance may cause material damage and damage to the appliance.

- ▶ Remove these objects, along with all supplied accessories, from the drum before starting the appliance.

1. Remove any packaging and protective covers completely from the appliance.

→ "Disposing of packaging",  
Page 11

2. Check the appliance for visible damage.

3. Open the door.
4. Remove any accessories from the drum.
5. Close the door.

### 4.2 Scope of delivery



After unpacking all parts, check for any damage in transit and completeness of the delivery.

#### ATTENTION!

If the appliance is operated with incomplete or defective accessories, the appliance may not be able to operate properly, or this may result in material damage or damage to the appliance.

- ▶ Do not operate the appliance with incomplete or defective accessories.
- ▶ Replace the accessories in question before operating the appliance.

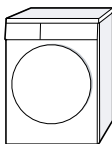
→ "Accessories", Page 24

Included with the appliance	Description
	Tumble dryer
	Accompanying documents

### 4.3 Requirements for the installation location

#### ATTENTION!

If the appliance is tilted at an angle greater than 40°, residual water may leak out of the appliance and cause material damage.

- ▶ Tilt the appliance carefully.

- ▶ Transport the appliance in an upright position. If residual water in the appliance freezes, this may cause damage to the appliance.
- ▶ Do not install or operate this appliance anywhere that is liable to experience frost or outdoors.

**Installation location Requirements**

On the floor

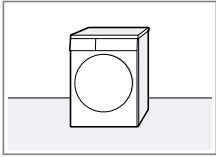

Place the appliance on a clean, level and firm surface. Align the appliance → *Page 13*.

In a washer-dryer stack

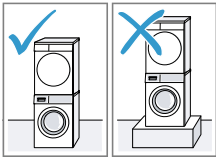

Only use the original connection set from the dryer manufacturer when setting up this appliance in a washer-dryer stack.

- Connection kit → *Page 24*

This appliance must only be stacked on a washing machine from the same manufacturer. The depth and width of this appliance must correspond with the dimensions of the washing machine. Do not place the washer-dryer stack on a platform.

**Installation location Requirements**

Against a wall

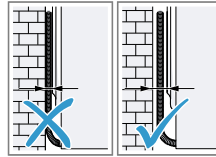

Do not trap the hoses and power cord between the wall and the appliance.

**4.4 Aligning the appliance**

In order to reduce vibrations and noises, align the appliance correctly.

- ▶ To align the appliance, turn the appliance feet. Check that the appliance is level using a spirit level.

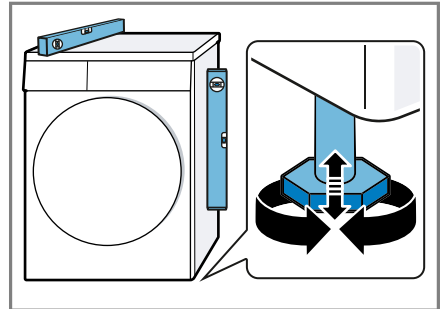

All appliance feet must stand firmly on the ground.

**4.5 Connecting the appliance to the electricity supply**

1. Insert the mains plug of the appliance's power cable in a socket nearby.

The connection details of the appliance can be found under Technical data → *Page 42*.

2. Check the mains plug is inserted properly.

---

## 5 Familiarising yourself with your appliance

### 5.1 Appliance

You can find an overview of the parts of your appliance here.

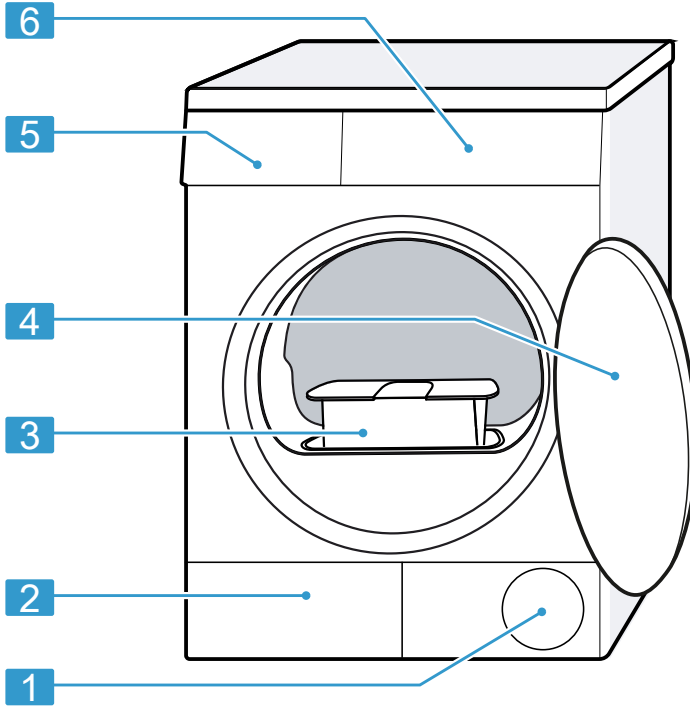

On certain models, specific details such as the colour and shape may differ from those pictured.

<b>1</b>	Ventilation opening	<b>4</b>	Door
<b>2</b>	Maintenance flap on the base unit → <i>Page 32</i>	<b>5</b>	Condensation container → <i>Page 28</i>
<b>3</b>	Fluff filter → <i>Page 26</i>	<b>6</b>	Control panel → <i>Page 15</i>

## 5.2 Control panel

You can use the control panel to configure all functions of your appliance and to obtain information about the operating status.

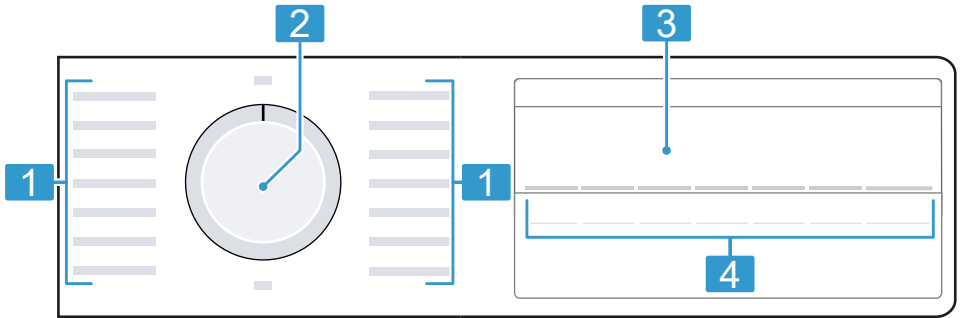

---

**1** Programmes → *Page 21*

---

**2** Programme selector  
→ *Page 25*

---

**3** Display → *Page 16*

---

**4** Buttons → *Page 18*





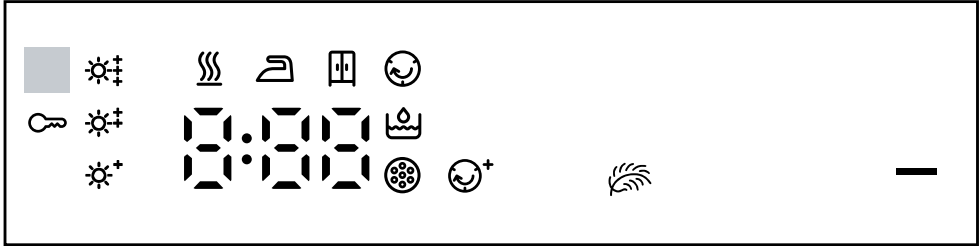

---

## 6 Display

The display shows the current settings, options or relevant information.









Example: Display

Display	Designation	Description
0:40 <sup>1</sup>	Programme duration/programme time remaining	Expected programme duration or programme time remaining in hours and minutes.
1:25	Timed programme	The timed programme is set. → "Timed programmes", Page 22
10h <sup>1</sup>	Programme end time	→ "Buttons", Page 19
	Childproof lock	<ul style="list-style-type: none"> <li>lights up: The childproof lock is activated.</li> <li>flashes: The childproof lock is activated and the appliance has been operated. → "Deactivating the childproof lock", Page 29</li> </ul>
	Start/Pause	Start, cancel or pause <ul style="list-style-type: none"> <li>Lights up: The programme is running and can be cancelled or paused.</li> <li>Flashes: The programme can be started or continued.</li> </ul>
  	Dryness level adjusted	The adjusted dryness level is activated. → "Dryness level", Page 20
	Crease-reduction function	The crease-reduction function is activated. → "Buttons", Page 18
	Gentle drying	Gentle drying is activated for delicate fabrics. → "Buttons", Page 18









<sup>1</sup> Example



Display	Designation	Description
	Condensation container	Empty the condensation container → <i>Page 28</i> . Insert the condensation container → <i>Page 28</i> .
	Fluff filter Base unit	Clean the fluff filter. → <i>"Cleaning the fluff filter", Page 26</i> Clean the base unit. → <i>"Base unit", Page 32</i>
	Drying	Programme status
	Dryness level: Iron Dry	Programme status
	Dryness level: Cupboard Dry	Programme status
	Anti-crease	Programme status
-P-	Pause	Programme status
End	End of programme	Programme status
<sup>1</sup> Example		

## 7 Buttons



Below is an overview of the buttons and their setting options.

Button	Selection	Description
	<ul style="list-style-type: none"> <li>■ Start</li> <li>■ Cancel</li> <li>■ Pause</li> </ul>	Start, cancel or pause the programme.
 3 sec.	<ul style="list-style-type: none"> <li>■ Activate</li> <li>■ Deactivate</li> </ul>	<p>Activate or deactivate the childproof lock.</p> <p>Disable the control panel to prevent unwanted or accidental operation.</p> <p>If the childproof lock is activated and the appliance has been switched off, the childproof lock remains activated.</p> <p>→ "Childproof lock", Page 28</p>
	<ul style="list-style-type: none"> <li>■ </li> <li>■ </li> <li>■ </li> </ul>	<p>Adjust the dryness level.</p> <p>If the laundry feels too damp after it has been dried to a particular dryness level, you can adjust the dryness level.</p> <p>→ "Adjusting the dryness level", Page 20</p>
	<ul style="list-style-type: none"> <li>■ Activate</li> <li>■ Deactivate</li> </ul>	<p>Activate or deactivate the crease-reduction function.</p> <p>Once the programme has ended, the drum moves the laundry at regular intervals for 120 minutes to prevent creasing.</p>
	<ul style="list-style-type: none"> <li>■ Activate</li> <li>■ Deactivate</li> </ul>	<p>Activate or deactivate gentle drying.</p> <p>The temperature is reduced for delicate fabrics, e.g. polyacrylic or elastane.</p> <p>The programme duration is extended.</p>

Button	Selection	Description
⌚	Up to 24 hours	Set the programme end time. The programme duration is already included in the set number of hours. Once the programme has started, the programme duration is displayed.
⌚	Multiple selection	Set the programme duration for timed programmes. → <i>"Timed programmes"</i> , <i>Page 22</i>

## 8 Dryness level

Each automatic programme has a specified dryness level. The dryness level defines how dry or damp your laundry is after the programme ends.

Dryness level	Laundry	Drying result
Cupboard Dry Plus 	Multi-layered, thick laundry that does not dry readily.	The laundry is dry.
Cupboard Dry 	Normal, single-layered laundry.	The laundry is dry.
Iron Dry 	Normal, single-layered laundry.	The laundry is still slightly damp. To prevent creasing after drying, iron the laundry or hang it up.





### 8.1 Changing the dryness level

For some automatic programmes, you can change the dryness level so that your laundry will be drier or more damp.

- ▶ Set an automatic programme with the desired dryness level.  
→ "Automatic programmes",  
Page 21

### 8.2 Adjusting the dryness level

If the laundry feels too damp after it has been dried to a particular dryness level, you can adjust the dryness level.

1. Set an automatic programme with the desired dryness level.  
→ "Automatic programmes",  
Page 21
  2. Press .
- ✓ The display shows ,  or .

## 9 Programmes

You can dry your fabrics using either an automatic programme or a timed programme.







### 9.1 Automatic programmes

Automatic programmes are programmes in which humidity sensors measure the residual moisture in the laundry during the drying cycle. The programme only ends once the set dryness level is reached.

Each automatic programme has a dryness level → *Page 20*. The dryness level defines how dry or damp the laundry is after the programme ends.





#### Tips

- Select the dryness level according to the type of fabric or the desired drying result.  
→ *"Dryness level", Page 20*
- The laundry's care labels provide you with additional information about programme selection.

Programme	Description	Max. load (kg)
Cottons  <ul style="list-style-type: none"> <li>■ Cupboard Dry Plus </li> <li>■ Cupboard Dry </li> <li>■ Iron Dry </li> </ul>	Dry hard-wearing, heat-resistant fabrics made of cotton or linen.	8.0
 Easy Care <ul style="list-style-type: none"> <li>■  Cupboard Dry Plus</li> <li>■  Cupboard Dry</li> <li>■  Iron Dry</li> </ul>	Dry items made of synthetic materials or blended fabrics.	3.5
Mix 	Dry items made of cotton and synthetics.	3.0
 Down Wear	Dry clothing, bedspreads or eiderdowns stuffed with down.	1.5

#### Notes



- Dry large items of laundry, such as blankets or sleeping bags, separately.
- Once the programme has ended, shake the items of laundry to distribute the stuffing and eliminate any pockets of moisture.
- If you dry the pillows and the pillows are not completely dry at the end of the programme, dry the pillows with a timed programme.  
→ *"Timed programmes", Page 22*

Programme	Description	Max. load (kg)
AllergyPlus 	Dry hard-wearing, heat-resistant fabrics made of cotton or linen. <b>Note:</b> Particularly suitable for strict hygiene requirements.	4.0
Sportswear 	Dry self-drying sportswear made of performance fibres, microfibres and synthetics.	1.5
 Shirts 15'	Suitable for shirts and blouses made of cotton, linen, synthetics or blended fabrics. <b>Note:</b> For optimal drying results, dry a maximum of 5 shirts or 5 blouses at the same time. Once the laundry is dry, iron it or hang it up. The residual moisture is then distributed evenly.	1.5
 Super Quick 40'	Dry items made of synthetics and light cotton.	2.0

## 9.2 Timed programmes

Timed programmes are programmes with a defined or adjustable programme duration. The programme ends once this time has elapsed, even if the laundry is still not dry, for example. Timed programmes are suitable for drying individual items of laundry or thin fabrics.

**Tip:** The laundry's care labels provide you with additional information about programme selection.

Programme	Description	Max. load (kg)
 Wool Finish	Dry machine-washable items made of wool or containing wool. <b>Note:</b> The laundry becomes fluffier but not dry. Remove laundry once the programme has ended and allow it to dry.	0.5
Time Program Cold 	Dry all types of fabric except for wool and silk. Also suitable for freshening up or airing clothing that has hardly been worn. <b>Note:</b> This programme is suitable for drying using the wool basket.	3.0

Programme	Description	Max. load (kg)
Time Program Warm Ⓢ	Dry all types of fabric except for wool and silk. Suitable for pre-dried or slightly damp laundry and for drying off multi-layered, thick laundry. <b>Note:</b> This programme is suitable for drying using the wool basket.	3.0

## 10 Accessories

Use original accessories. These have been made especially for your appliance.

**Note:** Some accessories are available in other colours. Contact → "Customer Service", Page 40.

	Use	Order number
Connection kit	To save space, stack the appliance on a suitable washing machine of the same width and depth and that is from the same manufacturer.	WTZ2041X
Wool basket	Dry or air individual woollen items, sports shoes and soft toys.	WMZ20600
Y-distributor	Connect the water drain hose of an additional appliance to the same siphon outlet.	15000490
Water drain hose	Drain away excess condensation directly into the waste water system, without having to regularly empty the condensation container.	WTZ1110
Platform	Install the appliance at a raised height so that it can be easily loaded and unloaded.	WMZ20540G

## 11 Laundry

### 11.1 Preparing the laundry

#### ATTENTION!

Objects remaining in the laundry may damage the laundry and the drum.

- ▶ Remove all items from any pockets in your laundry before using the appliance.

#### Note

The appliance and fabrics are protected when you prepare your laundry.

- Brush off sand and soil
- Sort the laundry according to colour and textiles and observe the care labels
- Close all zips, Velcro fasteners, hooks and eyes



- Remove curtain fittings and lead strips
- Load the laundry unfolded into the drum
- Spin the laundry before drying
- Dry woollen items, sports shoes and soft toys in the wool basket

---

## 12 Basic operation

### 12.1 Switching on the appliance

**Requirement:** The appliance has been correctly installed and connected.

→ *"Installation and connection", Page 12*

- ▶ Turn the programme selector to a programme.

**Note:** The lighting for the drum goes out automatically.

### 12.2 Setting a programme

1. Turn the programme selector and set the required programme.  
→ *"Programmes", Page 21*
2. If required, adjust the programme settings.  
→ *"Adjusting the programme settings", Page 25*

### 12.3 Adjusting the programme settings

Depending on the programme and programme progress, you can adjust or activate/deactivate the settings.

**Requirement:** A programme is set.  
→ *"Setting a programme", Page 25*

- ▶ Adjust the programme settings.  
→ *"Buttons", Page 18*

**Note:** The programme settings are not saved permanently for the programme.

### 12.4 Loading laundry

**Note:** To prevent creasing, note the maximum load for the programmes.  
→ *"Programmes", Page 21*

#### Requirements

- The laundry is prepared and sorted.  
→ *"Laundry", Page 24*
  - The drum is empty.
1. Open the door.
  2. Place the laundry in the drum.
  3. Close the door.  
Ensure that there is no laundry trapped in the door.

### 12.5 Starting the programme

**Requirement:** A programme is set.  
→ *"Setting a programme", Page 25*

- ▶ Press .
- ✓ The display shows the programme duration or the programme end time.
- ✓ After the programme has ended, the display shows: "End".

### 12.6 Changing the activated programme end time



You can repeatedly change the set and activated programme end time before starting the programme.

#### Requirements

- The programme is set.  
→ *"Setting a programme", Page 25*
  - The programme end time is set and activated.  
→ *"Buttons", Page 19*
1. Press .

en operation



The activated programme end time is paused.

2. Press  until the display shows the required programme end time.
3. Press .

The changed programme end time is activated.

## 12.7 Adding laundry

After the programme starts, you can remove or add laundry at any time.

1. Press .
2. Open the door.
3. Add or remove laundry.
4. Close the door.
5. Press .

## 12.8 Cancelling the programme

1. Press .
2. Open the door.
3. Remove the laundry.  
→ "Unloading the laundry",  
Page 26

## 12.9 Unloading the laundry

1. Open the door.
2. Remove the laundry from the drum.

## 12.10 Switching off the appliance

- ▶ Turn the programme selector to **Off**.

## 12.11 Fluff filter

During drying, fluff from the laundry is collected in the fluff filter. The fluff filter protects the appliance from fluff.

### Cleaning the fluff filter

If the drying programme has finished or the display shows a notification while the appliance is in operation, clean the fluff filter.

**Note:** If you do not clean the appliance as described, the appliance's functionality may be impaired.

### Requirements

- The display shows the following after drying: "End"
  - or the display shows the following during operation: 
1. Open the door.
  2. Remove the fluff from the door.

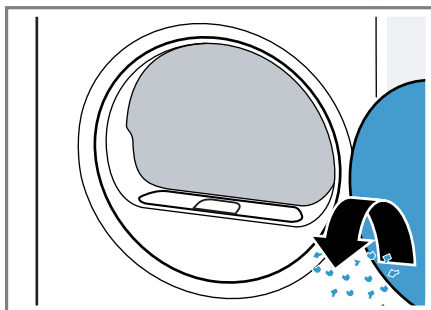

3. Remove the fluff filter.

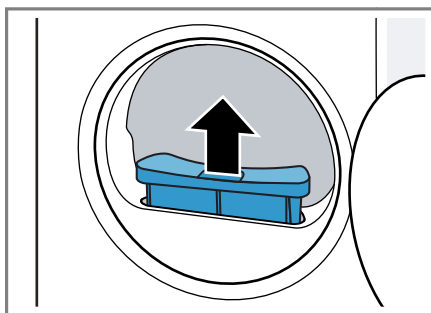

4. Remove the fluff from the recess.

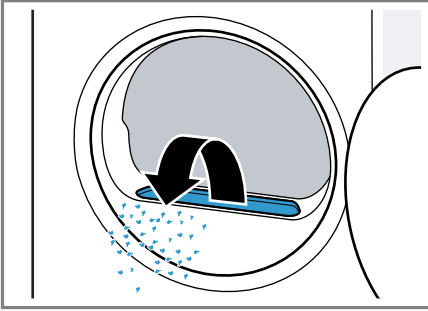

Ensure that no fluff falls into the air channel.

5. Open the fluff filter.

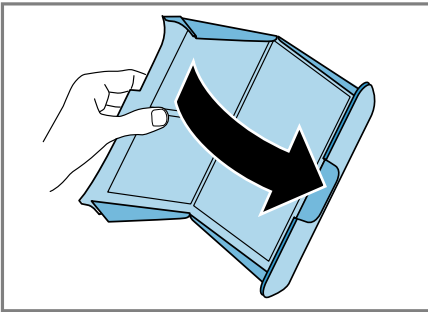

6. Remove the fluff.

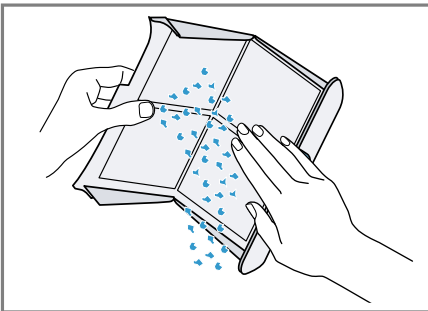

7. Clean the fluff filter thoroughly under warm, running water and then dry it off.

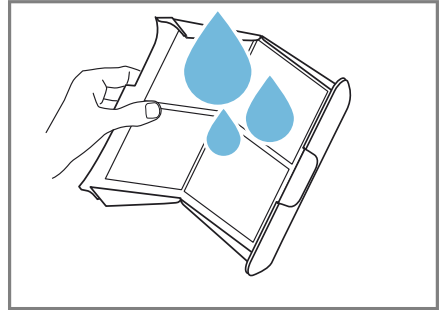

8. Close the fluff filter.

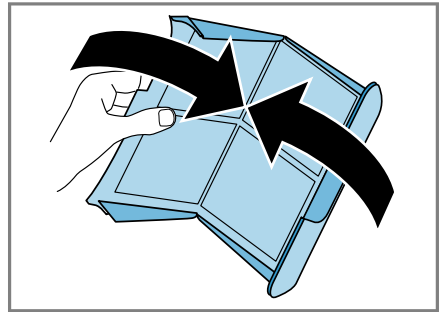

9. Insert the fluff filter.

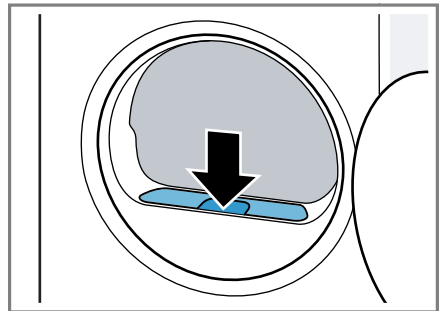

10. Close the door.

## 12.12 Condensation container

Condensation forms during drying, which your appliance uses for automatic cleaning. By default, the condensation is collected in the appliance's condensation container.

### Emptying the condensation container

If the drying programme has finished or the display shows a notification while the appliance is in operation, empty the condensation container.

#### Requirements

- The display shows the following after drying: "End"
  - or the display shows the following during operation: ㄹ
1. Pull out the condensation container, keeping it level.

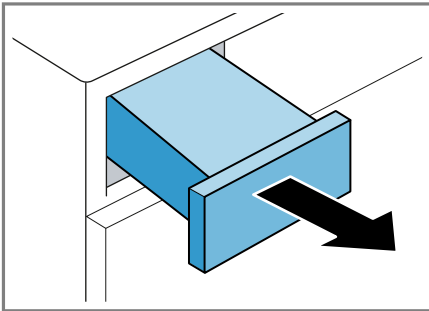

2. Empty the condensation container.

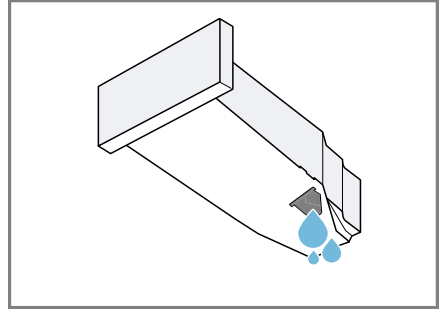

Make sure that you insert the condensation container before operating the appliance.

→ "Inserting the condensation container", Page 28

### Inserting the condensation container

- ▶ Push the condensation container in as far as it will go.

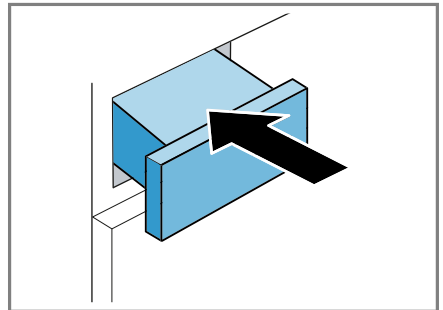

---

## 13 Childproof lock

Secure your appliance against being operated unintentionally using the controls.



### 13.1 Activating the childproof lock

- ▶ Press and hold the two  **3 sec.** buttons for approx. 3 seconds.

- ✓ The display shows .
- ✓ The control elements are locked.
- ✓ The childproof lock remains active even after the appliance has been switched off and in the event of a power cut.

## 13.2 Deactivating the childproof lock

**Requirement:** To deactivate the childproof lock, the appliance must be switched on.

- ▶ Press and hold the two  **3 sec.** buttons for approx. 3 seconds.
- ✓  goes out in the display.

## 14 Basic settings

You can configure the basic settings for your appliance to meet your needs.

### 14.1 Overview of the basic settings

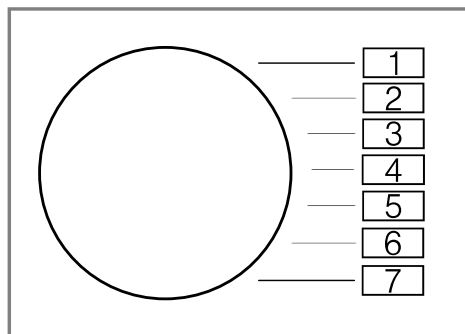

Basic setting	Programme position	Value	Description
End signal	3	0 (off) 1 (quiet) 2 (medium) 3 (loud) 4 (very loud)	Set the volume of the signal at the end of the programme.
Button signal	4	0 (off) 1 (quiet) 2 (medium) 3 (loud) 4 (very loud)	The volume of the audible signal emitted when the buttons are pressed.
Washing machine spin speed	2	Example: 600 (low) ✓ 1800 (high)	Set the spin speed of the washing machine. The set value increases or decreases the displayed duration of the automatic programmes.
Fuse	5	LO (10 A) HI (13 A)	Set the value for the appliance's fuse. <b>Note:</b> The values for the energy label are determined using a circuit breaker/fuse rating of 13 A. If the circuit breaker/fuse rating is

Basic setting	Programme position	Value	Description
			changed to 10 A, the drying time and energy consumption will be higher. → "Consumption values", Page 41

## 14.2 Changing the basic settings

1. Set the programme selector to position 1.

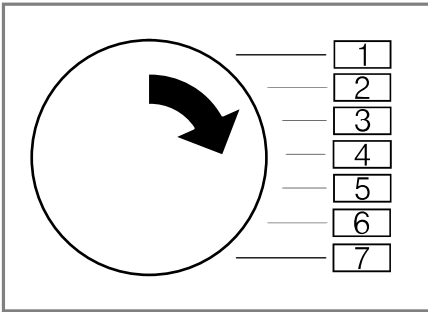

2. Press **D** and, at the same time, turn the programme selector to position 2.  
✓ The display shows the current value.
3. Set the programme selector to the required position.  
→ "Overview of the basic settings", Page 30
4. To change the value, press **⌚** / **⌚**.
5. To save the changes, switch off the appliance.

## 15 Cleaning and servicing

To keep your appliance working efficiently for a long time, it is important to clean and maintain it carefully.

### 15.1 Tips on cleaning and care

Wipe down the housing and the controls with nothing but water and a damp cloth.	This ensures the parts of the appliance will remain clean and hygienic.
Remove all detergent residue, spray residue or other residues immediately.	Fresh deposits are easier to remove without leaving any residue.
Leave the appliance door open after use.	This allows the residual water to dry, reducing odours in the appliance.

## 15.2 Base unit

The base unit is the accessible area at the bottom of the appliance in which you will find the heat exchanger.

### Opening the base unit

#### Requirements

- The appliance has cooled down for 30 minutes.
- The appliance door is closed.

1. Open the maintenance flap.

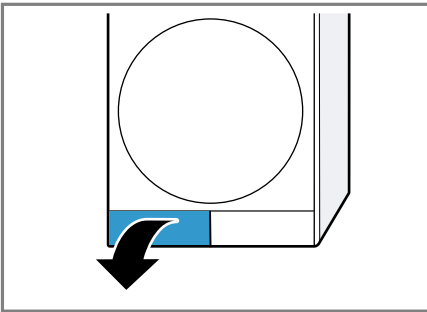

If you place a cloth beneath the maintenance flap, you can collect the remaining water from the base unit.

2. Open the lever for the heat exchanger cover.

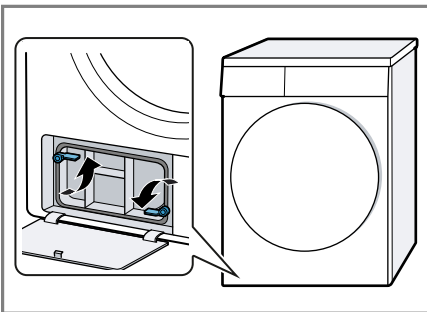

3. Pull out the heat exchanger cover by the handle.

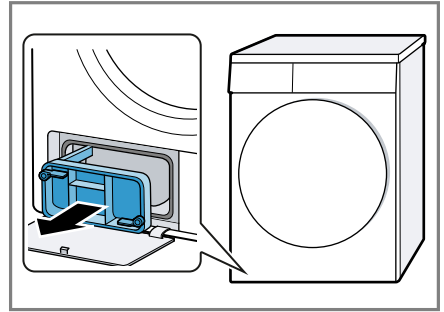

### Cleaning the base unit

You can remove any visible dirt in the base unit.

#### ATTENTION!

Heavy or sharp objects may damage the heat exchanger.

- ▶ Do not use hard, sharp or rough objects for cleaning.

1. Open the base unit → *Page 32*.
2. Clean the heat exchanger cover under running water and dry it.

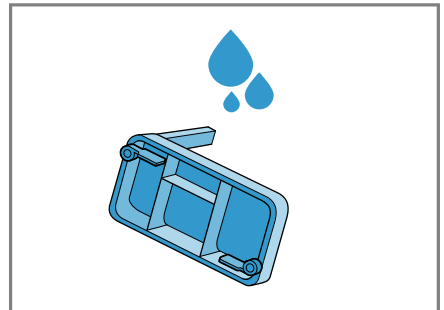

Make sure that you remove all dirt from the seal.



3. Pull out the heat exchanger horizontally.

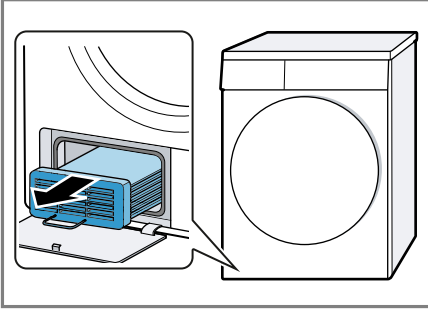

4. Clean the heat exchanger from all sides under running water and dry it.

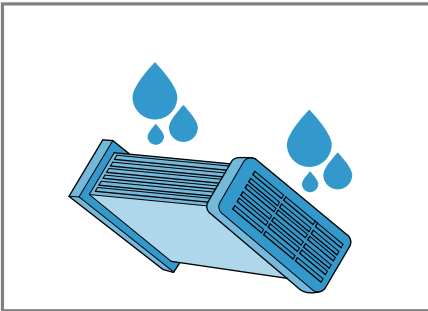

5. Clean the opening with a soft, damp cloth.

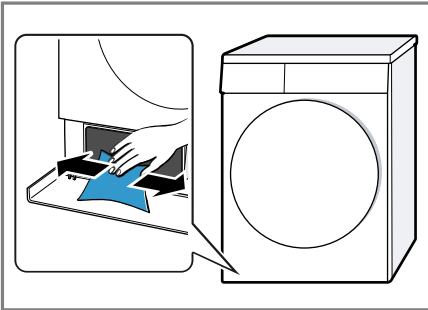

6. Slide the heat exchanger in horizontally as far as it will go.

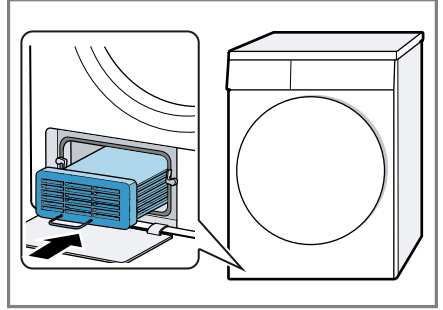

Ensure that the heat exchanger is inserted with its handle pointing downwards.

7. Close the base unit → *Page 33*.

### Closing the base unit

**Requirement:** The base unit is open.  
→ "*Opening the base unit*", *Page 32*

1. Insert the heat exchanger cover by the handle.

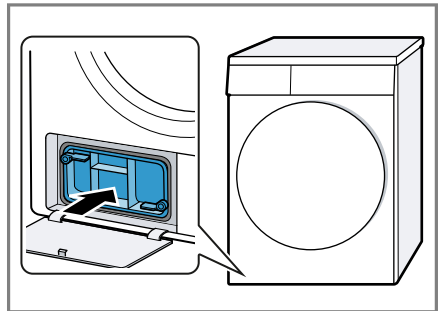

## en Cleaning and servicing

2. Close the lever for the heat exchanger.

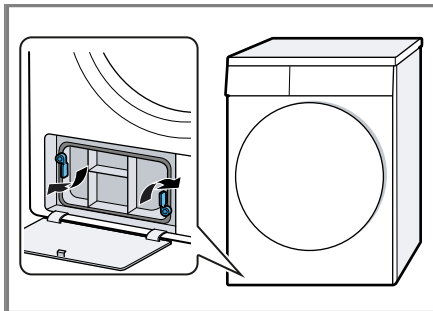

3. Close the maintenance flap.

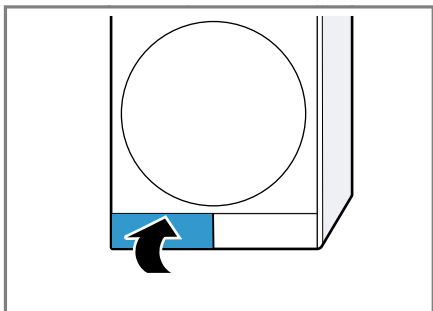

### 15.3 Moisture sensor

The moisture sensor in this appliance measures how damp the laundry is during the drying cycle. The appli-

ance changes the duration of the automatic programme depending on the residual moisture in the laundry.

#### Cleaning the moisture sensor

Over time, residue from limescale, detergents and care products can build up on the moisture sensor. Clean the moisture sensor regularly.

#### ATTENTION!

Hard or rough objects may damage the moisture sensor.

- ▶ Do not use hard or rough objects, abrasive cleaning products or steel wool for cleaning.

**Note:** If you do not clean the appliance as described, the appliance's functionality may be impaired.

1. Open the door.
2. Clean the moisture sensor with a sponge.

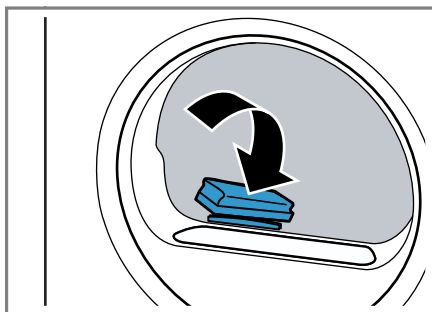

## 16 Troubleshooting

You can rectify minor faults on your appliance yourself. Read the troubleshooting information before contacting after-sales service. This will avoid unnecessary costs.





### WARNING

#### Risk of electric shock!

Incorrect repairs are dangerous.

- ▶ Repairs to the appliance should only be carried out by trained specialist staff.
- ▶ Only use genuine spare parts when repairing the appliance.
- ▶ If the power cord of this appliance is damaged, it must be replaced by the manufacturer, the manufacturer's Customer Service or a similarly qualified person in order to prevent any risk.

Fault	Cause and troubleshooting
Humming noise.	Compressor active. ▶ Not a fault – normal operating noise.
The display goes out and  flashes.	Energy-saving mode is active ▶ Press any button. ✓ The symbol lights up again.
	Fluff filter is soiled. ▶ → <i>"Cleaning the fluff filter", Page 26</i>
The appliance is not working.	The mains plug of the power cord is not plugged in. ▶ Connect the appliance to the power supply. <hr/> The circuit breaker in the fuse box has tripped. ▶ Check the circuit breaker in the fuse box. <hr/> There has been a power cut. ▶ Check whether the lighting in your kitchen or other appliances are working.
Creasing.	The load is too large. ▶ Observe the maximum load capacity of the → <i>"Programmes", Page 21</i> . <hr/> The laundry lies in the drum for too long after drying. <b>1.</b> Remove the laundry from the drum as soon as the drying programme has finished. <b>2.</b> Spread the items of laundry for cooling. <hr/> Unsuitable programme for the type of fabric. ▶ Set the suitable programme for the type of fabric. → <i>"Programmes", Page 21</i> <hr/> Easy-Care fabrics are dried for too long.

Fault	Cause and troubleshooting
Creasing.	<ul style="list-style-type: none"> <li>▶ → "Changing the dryness level", Page 20.</li> <li>▶ → "Adjusting the dryness level", Page 20.</li> </ul> <hr/> Anti-Crease not activated. <ul style="list-style-type: none"> <li>▶ Activate the Anti-Crease function. → "Buttons", Page 18</li> </ul>
☺ and programme terminated.	Condensation tank filled. <ol style="list-style-type: none"> <li>1. → "Emptying the condensation container", Page 28.</li> <li>2. → "Inserting the condensation container", Page 28.</li> <li>3. → "Starting the programme", Page 25.</li> </ol> <hr/> Water drain hose is caught or jammed. <ol style="list-style-type: none"> <li>1. Ensure that the water drain hose is not kinked or trapped.</li> <li>2. Route the water drain hose without kinks.</li> </ol> <hr/> Water drain hose is not connected correctly. <ul style="list-style-type: none"> <li>▶ Ensure that the water drain hose is connected correctly.</li> </ul> <hr/> Water drain hose is blocked. <ul style="list-style-type: none"> <li>▶ Rinse the water drain hose with tap water.</li> </ul> <hr/> Foreign object is located in the base unit <ol style="list-style-type: none"> <li>1. → "Opening the base unit", Page 32.</li> <li>2. Remove the foreign objects that are present.</li> <li>3. → "Closing the base unit", Page 33.</li> </ol>
Condensation in the condensation tank even though the water drain hose is connected.	The appliance uses condensation for the automatic self-cleaning. <ul style="list-style-type: none"> <li>▶ Not a fault – no action required.</li> </ul> <hr/> Water drain hose is not connected correctly. <ul style="list-style-type: none"> <li>▶ Ensure that the water drain hose is connected correctly.</li> </ul>
The programme does not start.	Childproof lock is activated. <ul style="list-style-type: none"> <li>▶ → "Deactivating the childproof lock", Page 29</li> </ul> <hr/> ☺ has not been pressed. <ul style="list-style-type: none"> <li>▶ Press ☺.</li> </ul> <hr/> No programme set. <ol style="list-style-type: none"> <li>1. → "Setting a programme", Page 25.</li> <li>2. → "Starting the programme", Page 25.</li> </ol>
The length of the programme changes during the drying cycle.	The programme operation is optimised electronically. This may change the programme duration. <ul style="list-style-type: none"> <li>▶ Not a fault – no action required.</li> </ul>

<b>Fault</b>	<b>Cause and troubleshooting</b>
Pumping noise.	Condensation pump active. ▶ Not a fault – normal operating noise.
Buzzing noise.	Compressor ventilation active. ▶ Not a fault – normal operating noise.
The drying time is too long.	Fluff filter is soiled. ▶ → <i>"Cleaning the fluff filter", Page 26</i>
	The ambient temperature is greater than 30 °C. ▶ Ensure that the ambient temperature is below 30 °C.
	The ambient temperature is lower than 15 °C. ▶ Ensure that the ambient temperature is above 15 °C.
	Insufficient air circulation at the appliance's installation location. ▶ Ventilate the appliance's installation location.
	The appliance's ventilation opening is blocked. ▶ Ensure that the ventilation opening of the appliance is kept clear.
	Heat exchanger is soiled. 1. Opening the base unit. → <i>"Opening the base unit", Page 32.</i> 2. Cleaning the heat exchanger. → <i>"Cleaning the base unit", Page 32.</i> 3. Closing the base unit. → <i>"Closing the base unit", Page 33.</i>
Water is leaking from the appliance.	Appliance is not correctly aligned. ▶ → <i>"Aligning the appliance", Page 13</i>
	Water drain hose is not connected correctly. ▶ Ensure that the water drain hose is connected correctly.
The laundry is too damp.	Unsuitable programme for the type of fabric. ▶ Set a timed programme for the subsequent drying. → <i>"Programmes", Page 21</i>
	There has been a power cut. ▶ Check whether the lighting in your kitchen or other appliances are working.
	The load is too large. ▶ Observe the maximum load capacity of the → <i>"Programmes", Page 21.</i>

Fault	Cause and troubleshooting
The laundry is too damp.	After the end of the programme, warm laundry feels damper than it actually is. <ol style="list-style-type: none"><li>1. Remove the laundry from the drum as soon as the drying programme has finished.</li><li>2. Spread the items of laundry for cooling.</li></ol>
	Unsuitable dryness level set. ▶ → <i>"Changing the dryness level", Page 20.</i>
	Drying target not adjusted. ▶ → <i>"Adjusting the dryness level", Page 20.</i>
	Load too small. ▶ Set a timed programme for the subsequent drying. → <i>"Programmes", Page 21</i>
	Moisture sensor dirty. ▶ → <i>"Cleaning the moisture sensor", Page 34.</i>
	The drying process is interrupted and the condensation tank has been filled. <ol style="list-style-type: none"><li>1. → <i>"Emptying the condensation container", Page 28.</i></li><li>2. → <i>"Inserting the condensation container", Page 28.</i></li><li>3. → <i>"Starting the programme", Page 25.</i></li></ol>

---

## 17 Transportation, storage and disposal

### 17.1 Preparing the appliance for transportation

**Tip:** The appliance may contain residual water, which may drip out of it when transported. The appliance should be transported upright.

#### Requirements

- The condensation container is emptied. Emptying the condensation container → *Page 28*
  - The appliance has been switched on.  
→ *"Switching on the appliance", Page 25*
1. Set any programme → *Page 25*.
  2. Start the programme → *Page 25* and wait 5 minutes.
- ✓ The condensation is drained.
3. Switch off the appliance.  
→ *"Switching off the appliance", Page 26*
  4. Remove the water drain hose from the connection point.
  5. Secure the water drain hose on the appliance against unintentional loosening.  
Ensure that you do not bend the water drain hose.
  6. Empty the condensation container  
→ *Page 28*.
  7. Insert the condensation container  
→ *Page 28*.
  8. Disconnect the appliance's mains plug from the power supply.
- ✓ The appliance is now ready to be transported.

### 17.2 Disposing of old appliance

Valuable raw materials can be re-used by recycling.

#### **WARNING**

##### **Risk of harm to health!**

Children can lock themselves in the appliance, thereby putting their lives at risk.

- ▶ Do not install the appliance behind a door as this may obstruct the appliance door or prevent it from opening.
- ▶ With redundant appliances, unplug the power cord. Then cut through the cord and damage the lock on the appliance door beyond repair so that the appliance door will no longer close.

1. Unplug the appliance from the mains.
2. Cut through the power cord.
3. Dispose of the appliance in an environmentally friendly manner.

Information about current disposal methods are available from your specialist dealer or local authority.



This appliance is labelled in accordance with European Directive 2012/19/EU concerning used electrical and electronic appliances (waste electrical and electronic equipment - WEEE). The guideline determines the framework for the return and recycling of used appliances as applicable throughout the EU.

---

---

## 18 Customer Service

Detailed information on the warranty period and terms of warranty in your country is available from our after-sales service, your retailer or on our website.

If you contact Customer Service, you will require the product number (E-Nr.) and the production number (FD) of your appliance.

The contact details for Customer Service can be found in the enclosed Customer Service directory or on our website.

### 18.1 Product number (E-Nr.) and production number (FD)

You can find the product number (E-Nr.) and the production number (FD) on the appliance's rating plate.



Depending on the model, the rating plate is located:

- On the inside of the door.
- On the inside of the maintenance flap.
- On the rear of the appliance.

Make a note of your appliance's details and the Customer Service telephone number to find them again quickly.





















## 19 Consumption values











The **Cottons**  **Cupboard Dry**  programme (denoted by the arrow symbol) is suitable for drying cotton laundry with a normal dampness level, and is the most efficient programme for drying damp cotton laundry in terms of combined energy consumption. The consumption values for this programme that are declared on the energy label refer to a moisture content of 60% of the laundry and a minimum installation protection of 13 A when it is delivered.

The values specified for other programmes are indicative only and were determined in accordance with the applicable standard EN61121.

The actual values may deviate from the indicated values depending on the type of fabric, composition of laundry to be dried, residual moisture in the fabric, set degree of dryness, amount of laundry being loaded, environmental conditions and the activation of additional functions.

The expected programme duration/"Ready in" time that is shown on the appliance display when selecting the programme is based on the spin speed in the washing machine of 1000 rpm when the appliance is delivered.

Programme	Final moisture level (%)	Load (kg)	Spin speed (rpm)	Initial moisture level (%)	Programme duration (h:min)	Energy consumption (kWh/cycle)
Cottons  Cupboard Dry 	0.0	8.0	1400	50	02:16 / 01:55	4.52 / 4.41
Cottons  Cupboard Dry 	0.0	4.0	1400	50	01:25 / 01:05	2.54 / 2.49
Cottons  Cupboard Dry 	0.0	8.0	1000	60	02:38 / 02:17	4.76 / 4.63
Cottons  Cupboard Dry 	0.0	4.0	1000	60	01:39 / 01:19	2.68 / 2.61
Cottons  Cupboard Dry 	0.0	8.0	800	70	03:00 / 02:39	5.01 / 4.85
Cottons  Cupboard Dry 	0.0	4.0	800	70	01:53 / 01:33	2.81 / 2.73
Cottons  Iron Dry 	12.0	8.0	1400	50	01:53 / 01:26	3.41 / 3.39
Cottons  Iron Dry 	12.0	4.0	1400	50	01:04 / 00:48	1.94 / 1.91
Cottons  Iron Dry 	12.0	8.0	1000	60	02:15 / 01:48	3.65 / 3.61

Programme	Final moisture level (%)	Load (kg)	Spin speed (rpm)	Initial moisture level (%)	Programme duration (h:min)	Energy consumption (kWh/cycle)
Cottons  Iron Dry 	12.0	4.0	1000	60	01:18 / 01:02	2.08 / 2.03
Cottons  Iron Dry 	12.0	8.0	800	70	02:37 / 02:10	3.90 / 3.83
Cottons  Iron Dry 	12.0	4.0	800	70	01:32 / 01:16	2.21 / 2.15
 Easy Care  Cupboard Dry	2.0	3.5	800	40	00:52 / 00:46	1.46 / 1.42
 Easy Care  Cupboard Dry	2.0	3.5	600	50	01:02 / 00:56	1.80 / 1.75

## 20 Technical data

Appliance height	84.2 cm
Appliance width	59.8 cm
Appliance depth	61.3 cm
Appliance depth with door closed	66.5 cm
Appliance depth with door open	110.5 cm
Weight	43.3 kg
Maximum load	8.0 kg
Mains voltage	220-240 V, 50 Hz

 Minimum installation protection	13/10A
Nominal power	2800   2100 W
Power consumption	<ul style="list-style-type: none"> <li>■ Off mode: 0.10 W</li> <li>■ Left-on mode: 0.50 W</li> </ul>
Ambient temperature	<ul style="list-style-type: none"> <li>■ Minimum: 5 °C</li> <li>■ Maximum: 35 °C</li> </ul>
Length of the power cord	145 cm





## Thank you for buying a Bosch Home Appliance!

Register your new device on MyBosch now and profit directly from:

- **Expert tips & tricks for your appliance**
- **Warranty extension options**
- **Discounts for accessories & spare-parts**
- **Digital manual and all appliance data at hand**
- **Easy access to Bosch Home Appliances Service**

Free and easy registration – also on mobile phones:

**[www.bosch-home.com/welcome](http://www.bosch-home.com/welcome)**



## Looking for help? You'll find it here.

Expert advice for your Bosch home appliances, help with problems or a repair from Bosch experts.

Find out everything about the many ways Bosch can support you:

**[www.bosch-home.com/service](http://www.bosch-home.com/service)**

Contact data of all countries are listed in the attached service directory.

**BSH Hausgeräte GmbH**

Carl-Wery-Straße 34

81739 München, GERMANY

[www.bosch-home.com](http://www.bosch-home.com)

A Bosch Company



**9001840708** (030209)

en