

Before using for the first time, read the instruction manual and the safety information it contains.

## Setting up Home Connect

**Tip:** Connect your appliance to a mobile device. You can conveniently change all settings using the Home Connect app.

1. Install the Home Connect app on your mobile device and follow the instructions.



2. Scan the QR code with the Home Connect app.



## Overview of water hardness settings

You can find an overview of the water hardness values that can be selected here. A table of country-specific units can be found in the instruction manual.

| Hardness range | mmol/l    | Setting value |
|----------------|-----------|---------------|
| Soft           | 0 - 1.1   | 0 - 8         |
| Soft           | 1.2 - 1.4 | 9 - 10        |

|        |           |         |
|--------|-----------|---------|
| Medium | 1.5 - 1.8 | 11 - 12 |
| Medium | 1.9 - 2.1 | 13 - 15 |
| Medium | 2.2 - 2.9 | 16 - 20 |
| Hard   | 3.0 - 3.7 | 21 - 26 |
| Hard   | 3.8 - 5.4 | 27 - 38 |
| Hard   | 5.5 - 8.9 | 39 - 62 |

## Setting the water softening system

1. Press .
2. To open the basic settings, press for approx. 3 seconds.
3. Press repeatedly until the display shows "Water hardness".
4. Press or repeatedly until the right water hardness has been set.
5. To save the settings, press for approx. 3 seconds.

## Programmes

The programme data has been measured in the laboratory according to European standard EN 60436. The consumption figures depend on the programme and additional function selected.

The runtime will change if the rinse aid system is switched off or rinse aid needs to be added.

| Programme                | 1) Duration [h:min]                                  | 2) Energy [kWh] | 3) Water [l] |
|--------------------------|--|-----------------|--------------|
| Intensive 70°            | 1) 2:05 - 2:15<br>2) 1.300 - 1.400<br>3) 11.5 - 14.0 |                 |              |
| Auto<br>Auto 45-65°      | 1) 1:40 - 2:45<br>2) 0.900 - 1.500<br>3) 7.0 - 15.5  |                 |              |
| Eco<br>Eco 50°           | 1) 4:35<br>2) 0.730<br>3) 9.2                        |                 |              |
| Silence 50° <sup>1</sup> | 1) 4:00<br>2) 1.050<br>3) 11.0                       |                 |              |
| Glass 40°                | 1) 1:33 - 1:38<br>2) 0.800 - 0.850<br>3) 12.0 - 14.0 |                 |              |
| Express 65° - 1h         | 1) 1:00<br>2) 1.300<br>3) 10.5                       |                 |              |
| Express 45°              | 1) 0:29 <sup>2</sup><br>2) 0.800<br>3) 10.5          |                 |              |
| Favourite                | 1) 0:15 - 0:15<br>2) 0.050 - 0.050<br>3) 4.0 - 4.0   |                 |              |

<sup>1</sup> Suitable programme for running at night: it takes longer, but is extremely quiet.

<sup>2</sup> half standard load

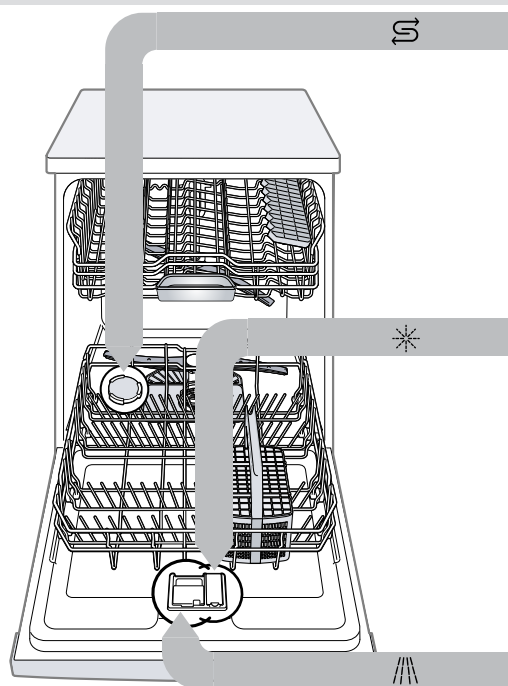

## Adding special salt

To avoid damage to the appliance, only add special salt to the dispenser for special salt just before the programme starts.

1. Unscrew the lid of the dispenser for special salt and remove.
2. On initial start-up: Fill the dispenser right up with water.

3. Add the special salt to the dispenser. The water in the dispenser is displaced and forced out. Never add detergent.

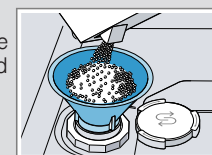

4. Place the lid back on the dispenser and turn to close.

## Adding rinse aid

1. Press the catch on the lid of the dispenser for rinse aid and lift .

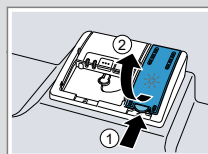

2. Add rinse aid up to the max mark.

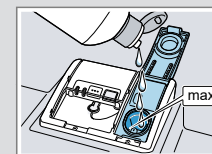

3. Close the lid of the dispenser for rinse aid.
  - ✓ The lid clicks into position.

## Adding detergent

1. Add the detergent to the dry detergent dispenser.

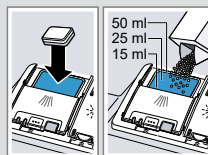

2. Close the lid of the detergent dispenser.
  - ✓ The lid clicks into position.

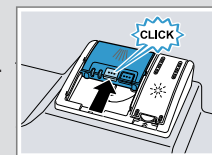

## How to use your appliance

1. Load the tableware. Only clean tableware that is suitable for dishwashers. Remove large remnants of food from the tableware. Check that the spray arms can rotate freely.
2. Add detergent.
3. Switch on the appliance .
4. Select the programme.
5. Start the programme Start.
6. Remove the tableware at the end of the programme.
7. To cancel the programme, press Reset 4 sec. for approx. 4 seconds. The programme is cancelled and ends after approx. 1 minute.



## Cleaning filters

1. After each wash check the filters for residue.
2. Turn the coarse filter anticlockwise ① and remove the filter system ②.

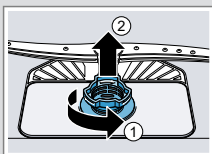

3. Pull down the micro filter to remove.

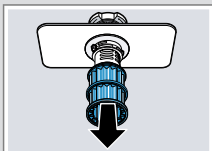

4. Press the locking catches ① together and lift the coarse filter out ②.

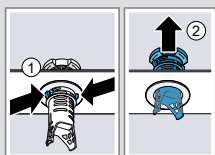

5. Clean the filter elements under running water.
6. Re-assemble the filter system.
7. Insert the filter system into the appliance and turn the coarse filter clockwise. Make sure that the arrow markings match up.

## Cleaning spray arms

1. Unscrew the upper spray arm ① and pull down to remove ②.

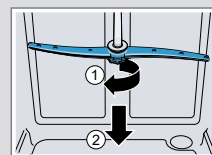

2. Pull up the lower spray arm to remove.

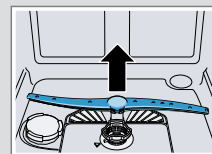

3. Check the outlet nozzles on the spray arms for blockages under running water and remove any foreign bodies.
4. Insert the lower spray arm.
  - ✓ The spray arm clicks into position.
5. Insert the upper spray arm and screw it firmly in place.

## Clean wastewater pump

1. Disconnect the appliance from the power supply.
2. Remove the filter system.
3. Scoop out any water.
4. Prise off the pump cover using a spoon and grip it by the crosspiece.

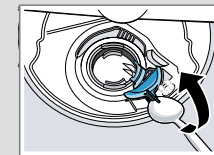

5. Lift the pump cover inwards at an angle and remove.
6. Remove any remnants of food and foreign bodies in the area of the impeller.
7. Insert the pump cover ① and press down ②.
  - ✓ The pump cover clicks into position.

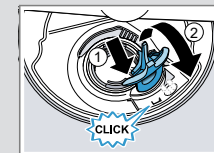

8. Install the filter system.

## Troubleshooting

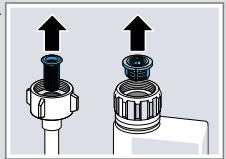
| Fault   | Cause and troubleshooting  |
|---|--|
| E:3200 or indicator for water supply lights up. | Supply hose is kinked. <ul style="list-style-type: none"> <li>▶ Install the supply hose without kinks.</li> </ul>  |
|   | Water tap is turned off. <ul style="list-style-type: none"> <li>▶ Turn on the water tap.</li> </ul>  |
|   | Water tap is jammed or furred up. <ul style="list-style-type: none"> <li>▶ Turn on the water tap.                             <ul style="list-style-type: none"> <li>The flow rate must be at least 10 l/min when the water supply is open.</li> </ul> </li> </ul>   |
|   | The filters in the water connection of the supply or AquaStop hose are blocked. <ol style="list-style-type: none"> <li>1. Switch off the appliance.</li> <li>2. Pull out the mains plug.</li> <li>3. Turn off the water tap.</li> <li>4. Unscrew the water connection.</li> <li>5. Remove the filter from the supply hose</li> </ol> |
|   |   |
|   | <ol style="list-style-type: none"> <li>6. Clean the filter.</li> <li>7. Re-insert the filter in the supply hose.</li> <li>8. Screw the water connection back on.</li> <li>9. Check the water connection for leaks.</li> <li>10. Restore the power supply.</li> <li>11. Switch the appliance on.</li> </ol>                           |

| Fault             | Cause and troubleshooting   |
|-------------------|---|
| E:9240 lights up. | Filters are soiled or blocked. <ul style="list-style-type: none"> <li>▶ Clean the filters.</li> </ul>   |
| E:6102 lights up. | Wastewater pump is blocked. <ul style="list-style-type: none"> <li>▶ Clean the wastewater pump.</li> </ul>  |
|                   | Cover of the wastewater pump is loose <ul style="list-style-type: none"> <li>▶ Secure the cover of the Wastewater pump so it clicks into position.</li> </ul>   |
|                   | Remnants of food on tableware. <ul style="list-style-type: none"> <li>Tableware is placed too close together or basket is overfilled.                             <ol style="list-style-type: none"> <li>1. Arrange tableware with sufficient space in between.                                     <ul style="list-style-type: none"> <li>The spray jets must reach the surfaces of the tableware.</li> </ul> </li> <li>2. Avoid points of contact.</li> </ol> </li> </ul> |
|                   | Spray arm rotation is blocked. <ul style="list-style-type: none"> <li>▶ Arrange tableware so that it does not obstruct spray arm rotation.</li> </ul>   |
|                   | Spray arm nozzles are blocked. <ul style="list-style-type: none"> <li>▶ Clean the Spray arms.</li> </ul>  |
|                   | Filters are soiled. <ul style="list-style-type: none"> <li>▶ Clean the filters.</li> </ul>  |
|                   | Filters are inserted incorrectly and/or not engaged. <ol style="list-style-type: none"> <li>1. Insert the filters properly.</li> <li>2. Engage the filters.</li> </ol>  |
|                   | Washing programme selected too weak. <ul style="list-style-type: none"> <li>▶ Select a more intensive washing programme.</li> <li>▶ Adjust the sensitivity of the sensors.</li> </ul>   |

| Fault   | Cause and troubleshooting   |
|---|---|
| Removable streaks are present on glasses, glassware with a metallic appearance and cutlery. | Amount of rinse aid to be dispensed is set too high. <ul style="list-style-type: none"> <li>▶ Set the rinse aid system to a lower setting.</li> </ul>   |
|   | No rinse aid has been added. <ul style="list-style-type: none"> <li>▶ Add rinse aid.</li> </ul>   |
| Rust spots on cutlery.  | Cutlery is not sufficiently rust-resistant. Knife blades are often more severely affected. <ul style="list-style-type: none"> <li>▶ Use rust-resistant tableware.</li> </ul>  |
|   | Cutlery may also rust if washed together with rusting items. <ul style="list-style-type: none"> <li>▶ Do not wash rusting items.</li> </ul>   |
| Detergent residue is present in the detergent dispenser or the tablet collecting tray.      | Spray arms were blocked by tableware so detergent was not rinsed out. <ul style="list-style-type: none"> <li>▶ Check that the spray arms are not blocked and can rotate freely.</li> </ul>  |
| All LEDs light up or flash or the rinse programme does not continue running.                | Electronics have detected a fault. <ul style="list-style-type: none"> <li>▶ Press the main switch button for approx. 4 seconds.                             <ul style="list-style-type: none"> <li>The appliance is reset and restarted.</li> </ul> </li> </ul> |