

9001800972

(040202)

642A_SK_86.5_GS_Tuerassi



- de** Montageanleitung
- sv** Installationsanvisningar
- no** Installasjonsveiledning

- fi** Asennusohjeet
- da** Installationsvejledning



- de** über den Kundendienst erhältlich
- sv** går att beställa via service
- no** fås hos kundeservice

- fi** saatavissa huoltopalvelusta
- da** Fås hos kundeservice

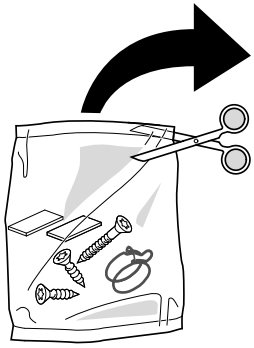

Ø4X36 Ø4X30

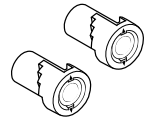

Ø4X15

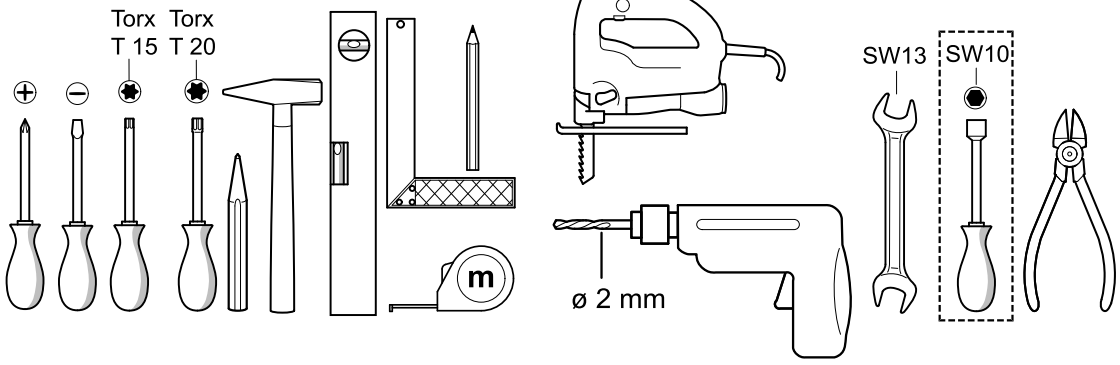
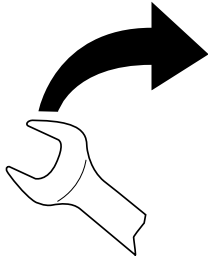
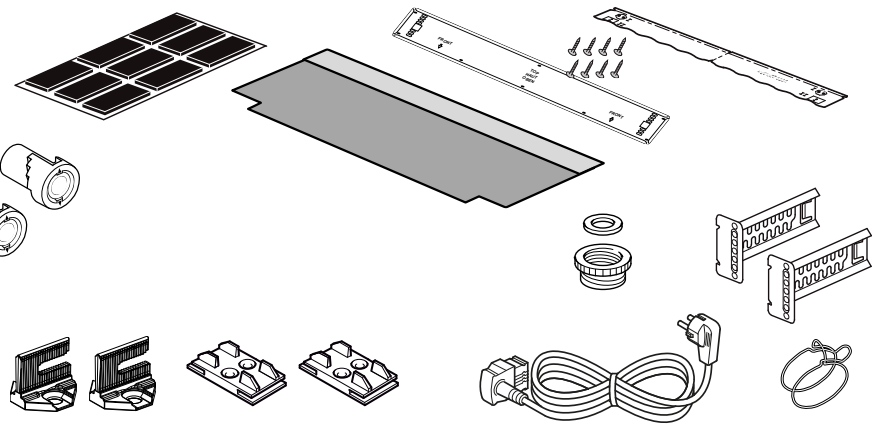
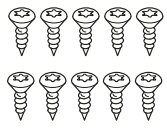

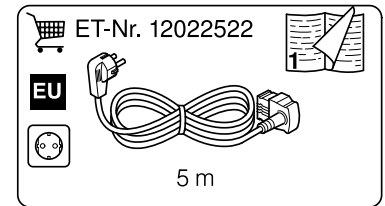
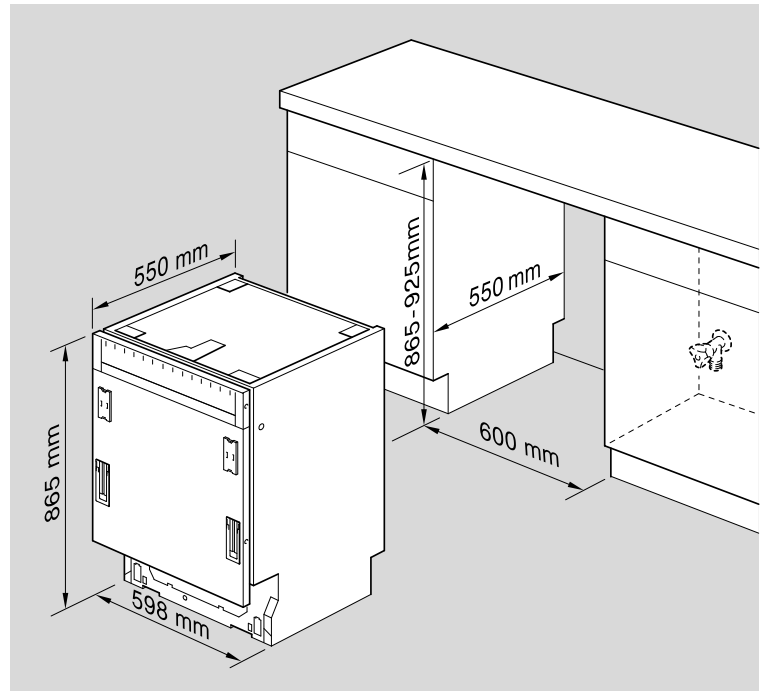
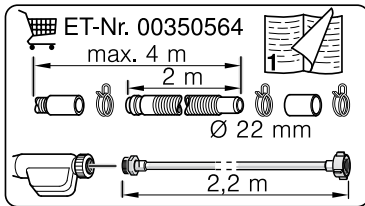
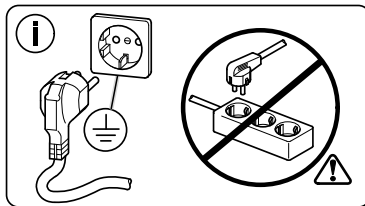
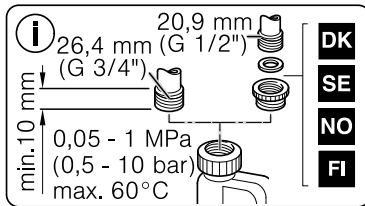
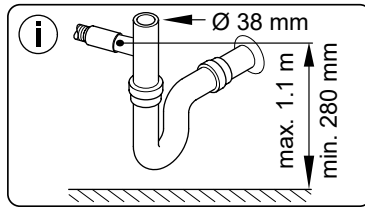

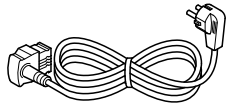

ET-Nr. 12022522

EU 5 m

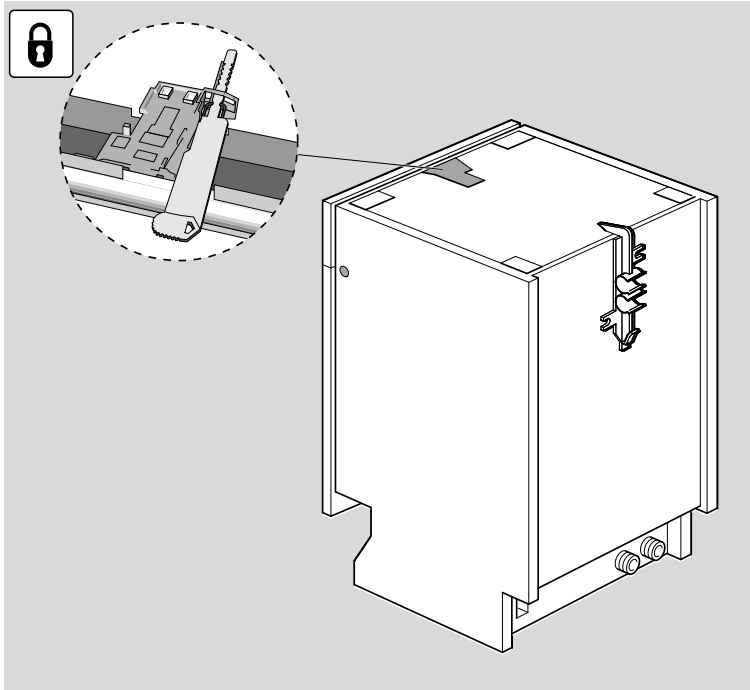
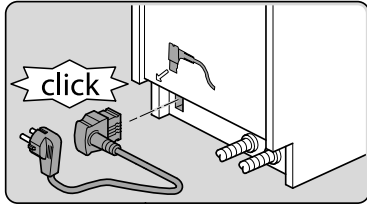
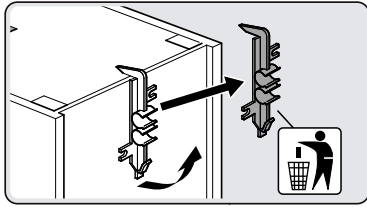

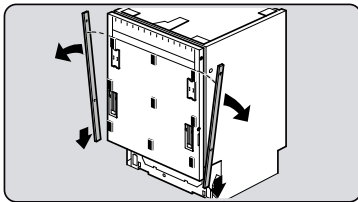
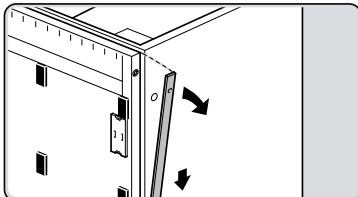
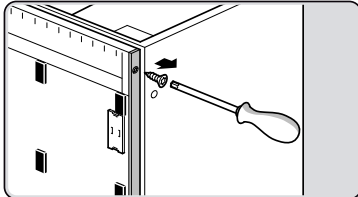
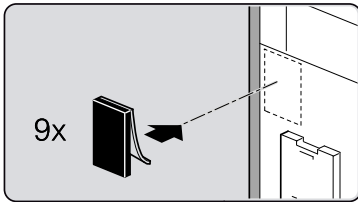
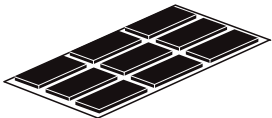

Torx
T 15

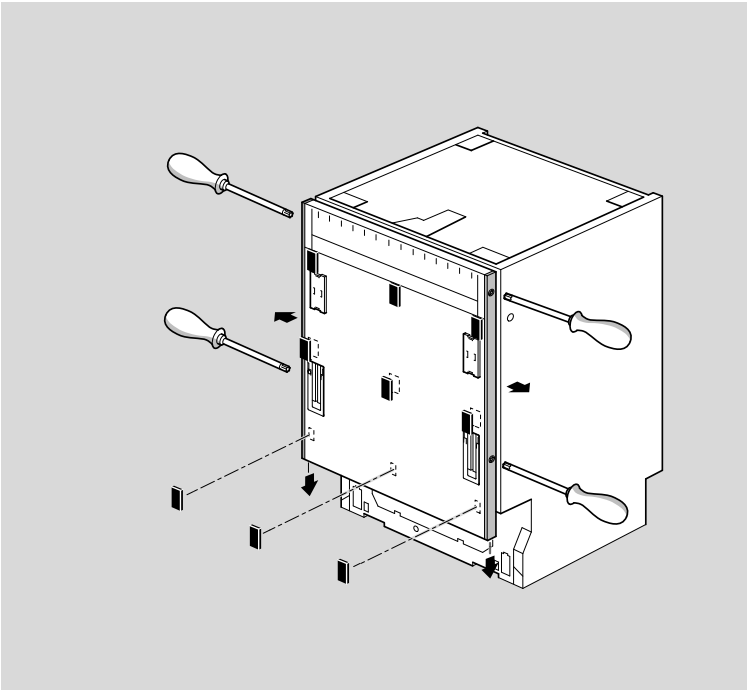

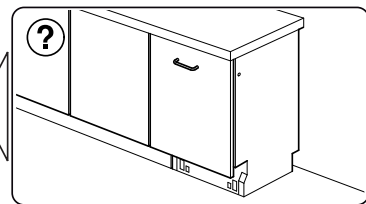
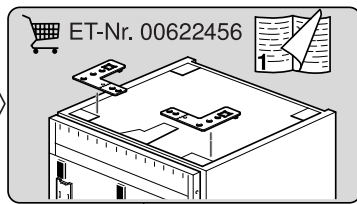
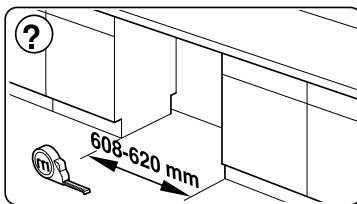
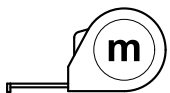
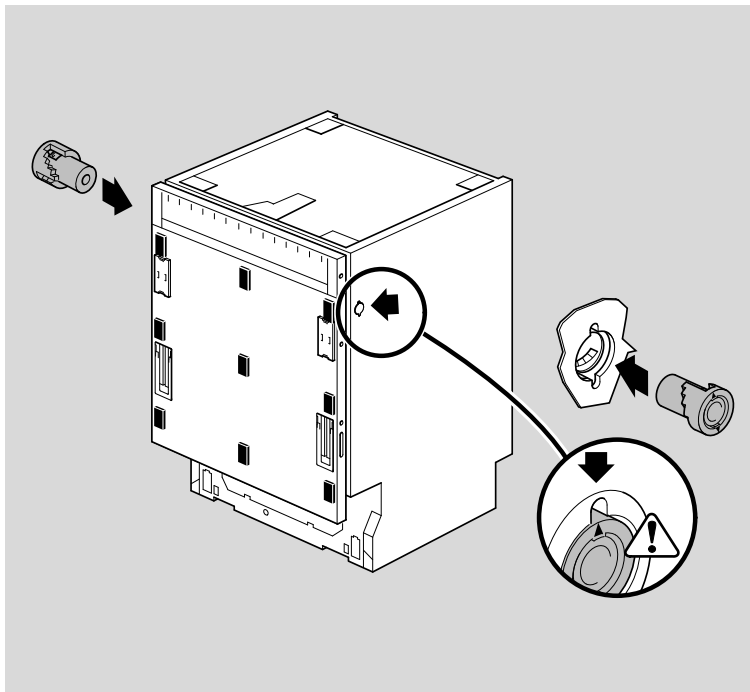
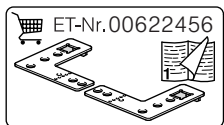
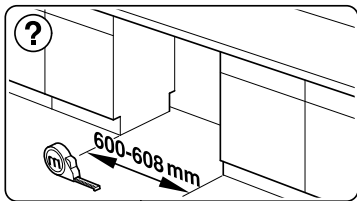
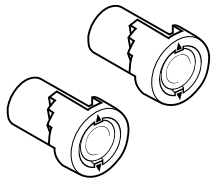

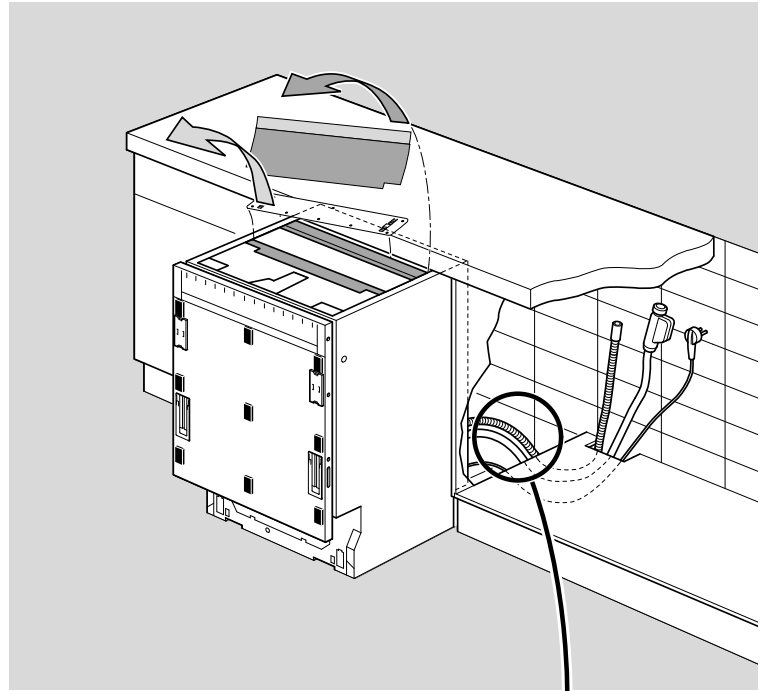
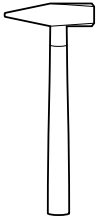
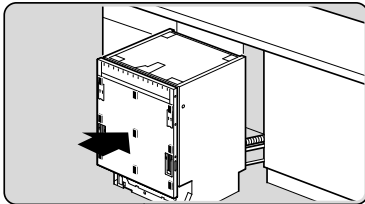
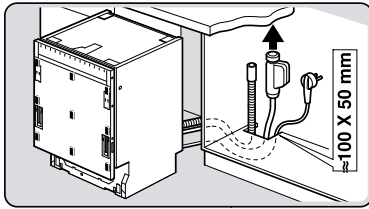
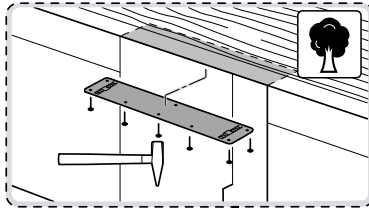
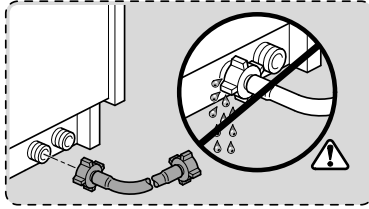
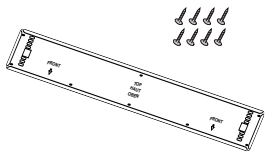

nicht einklemmen
do not pinch
ne pas coincer
No doblar

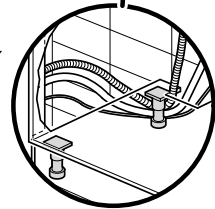

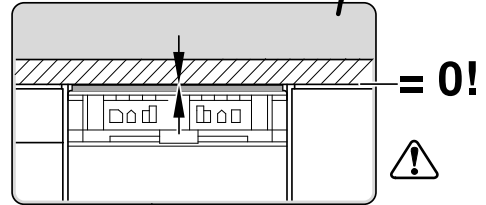
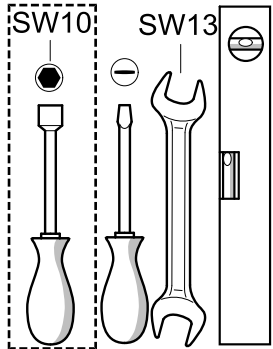
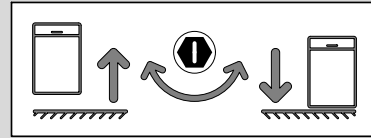
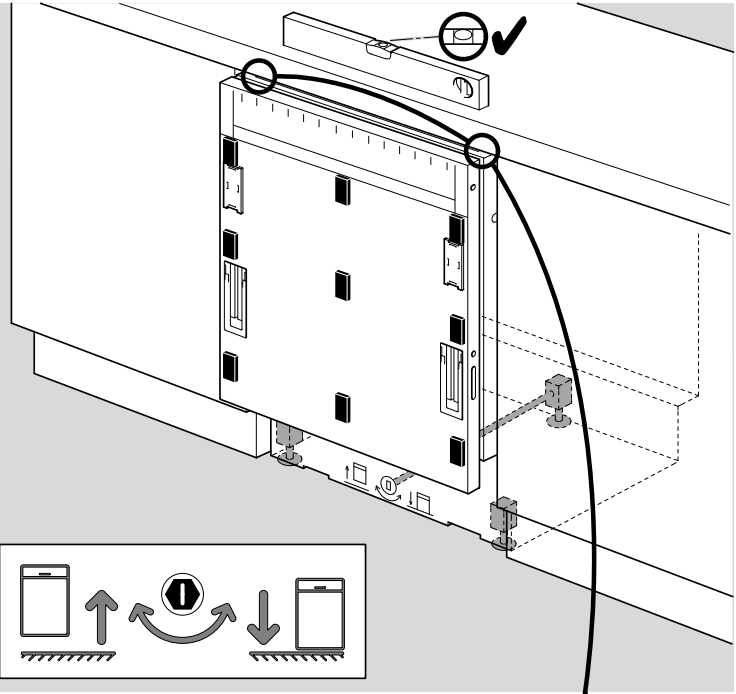
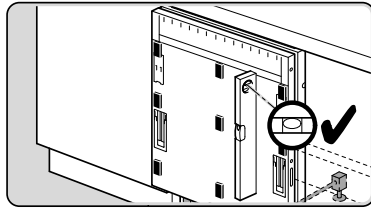
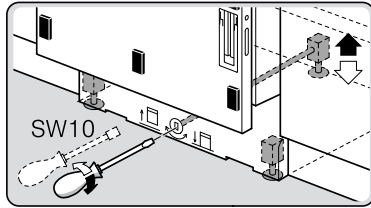
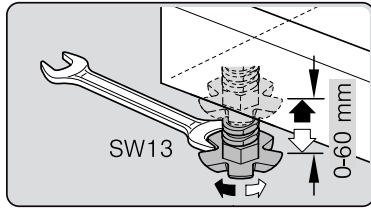

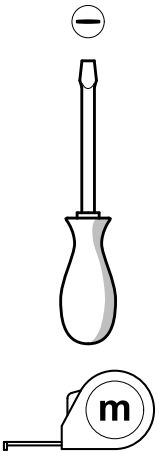
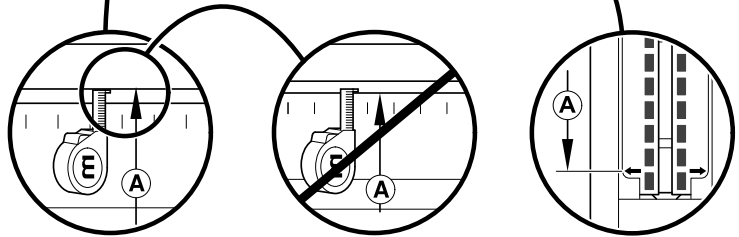
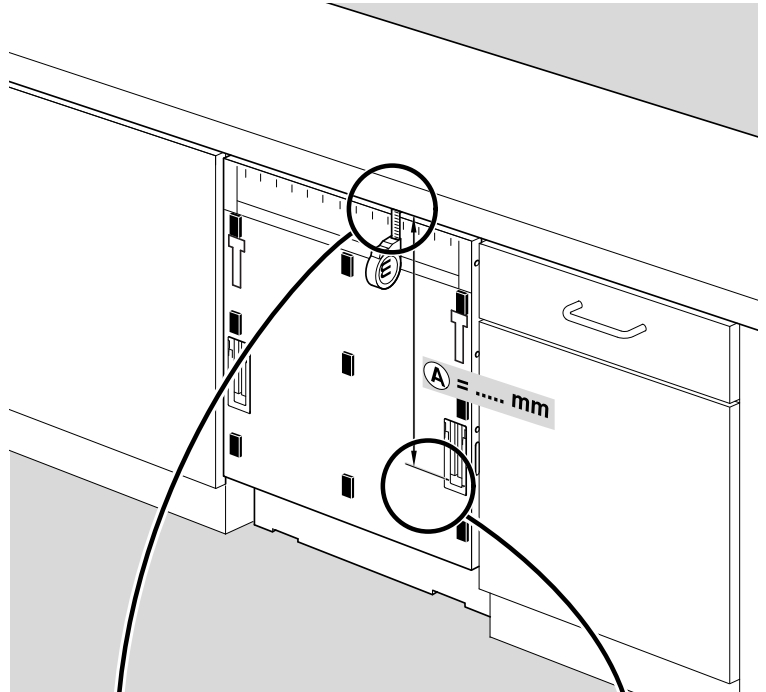
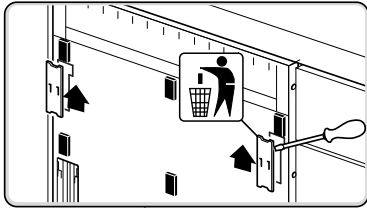

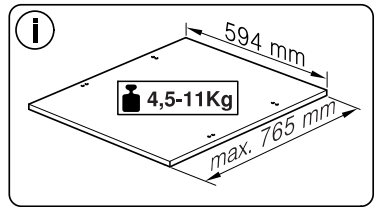
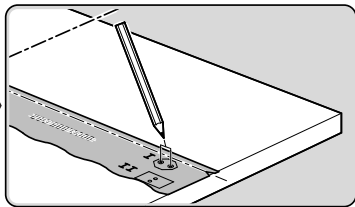
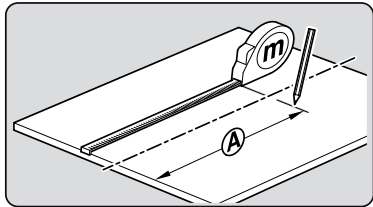
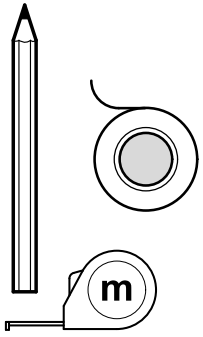
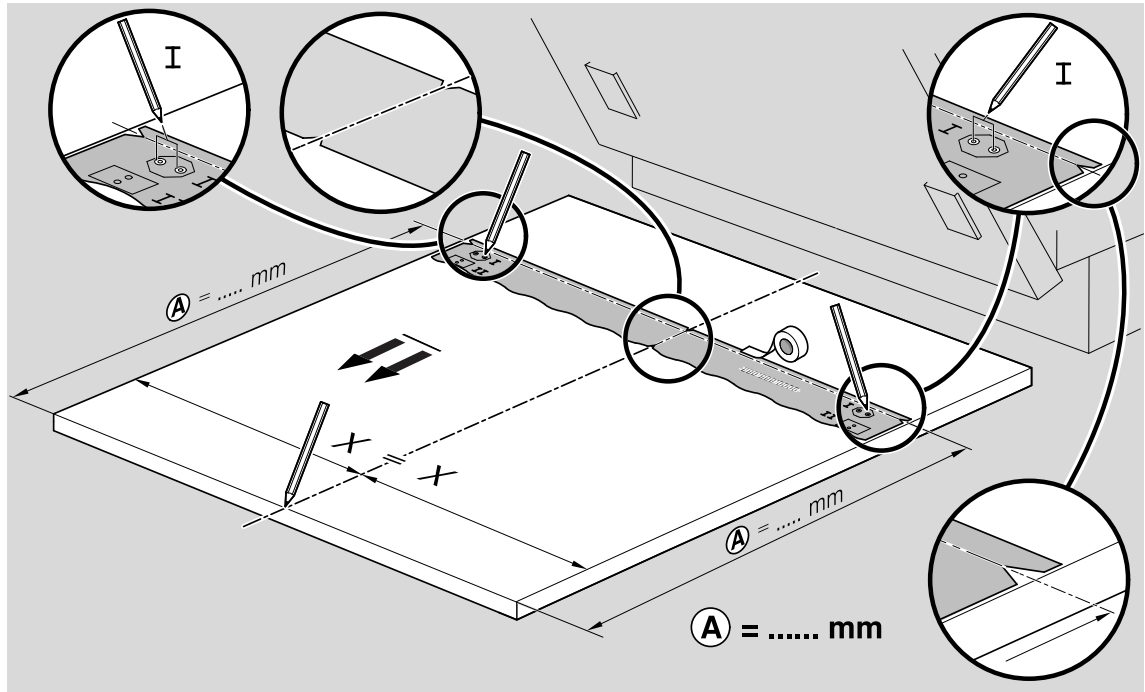
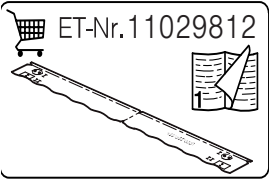
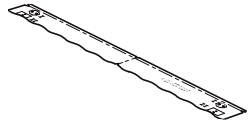

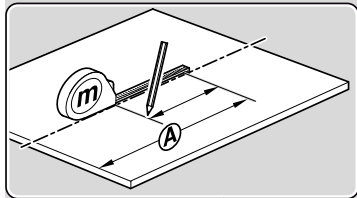
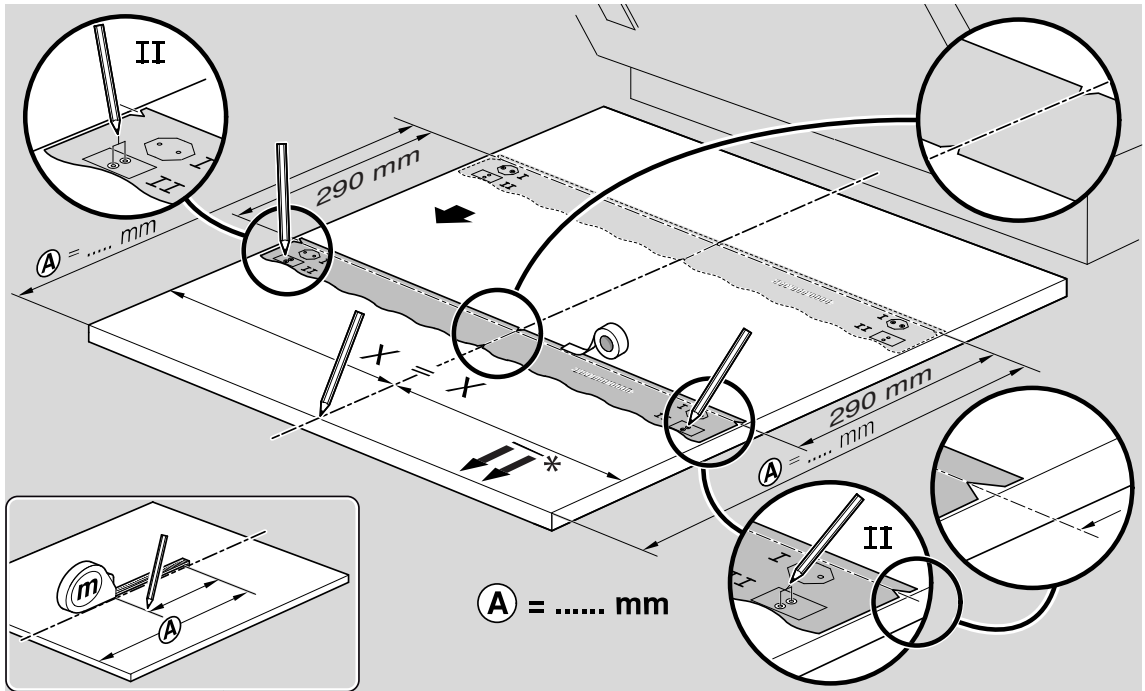

A = mm

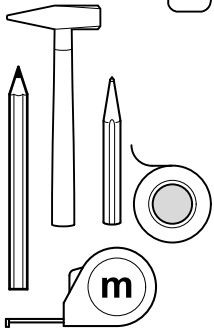
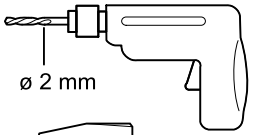
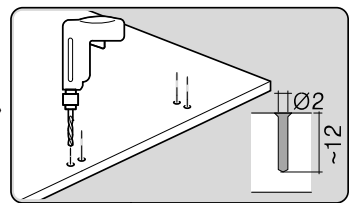
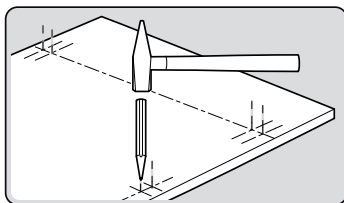
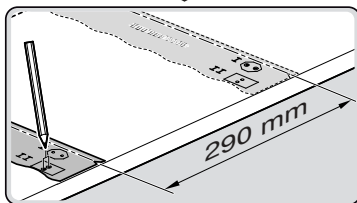

Ø4X15

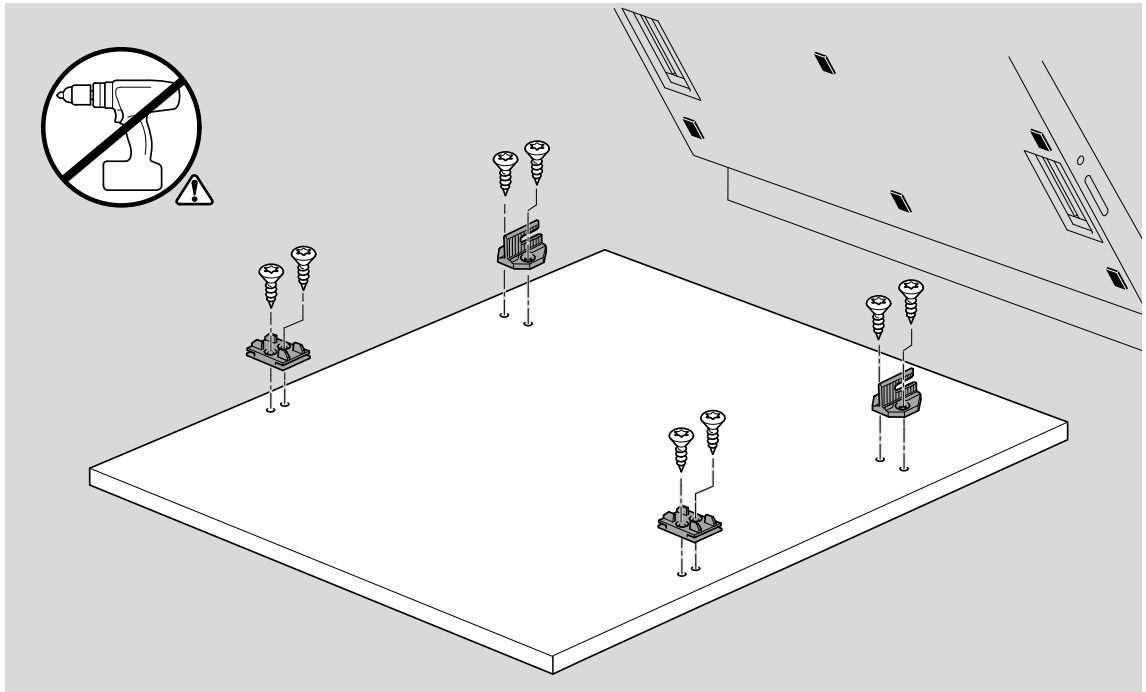
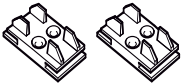
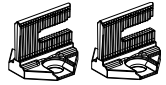

Torx
T 20

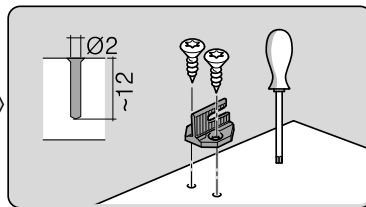
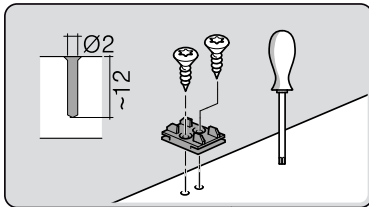
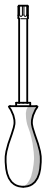

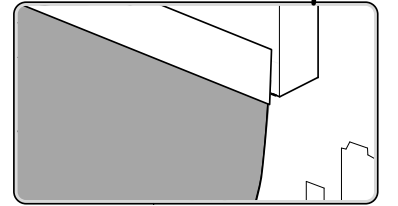
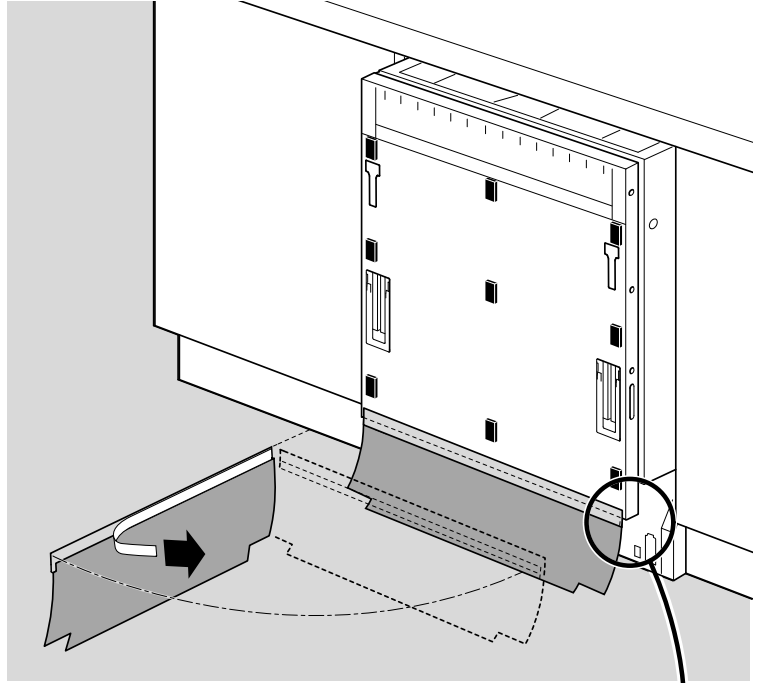
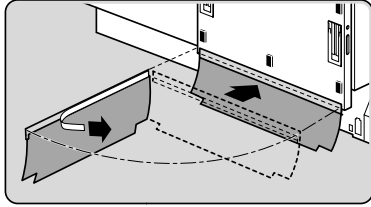
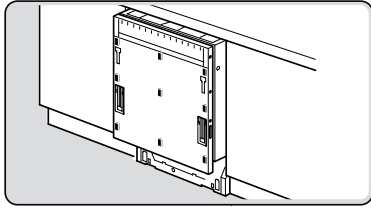
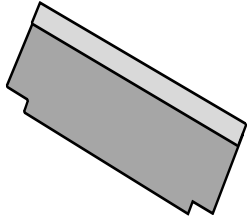

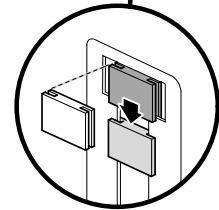
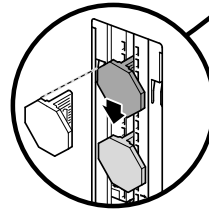
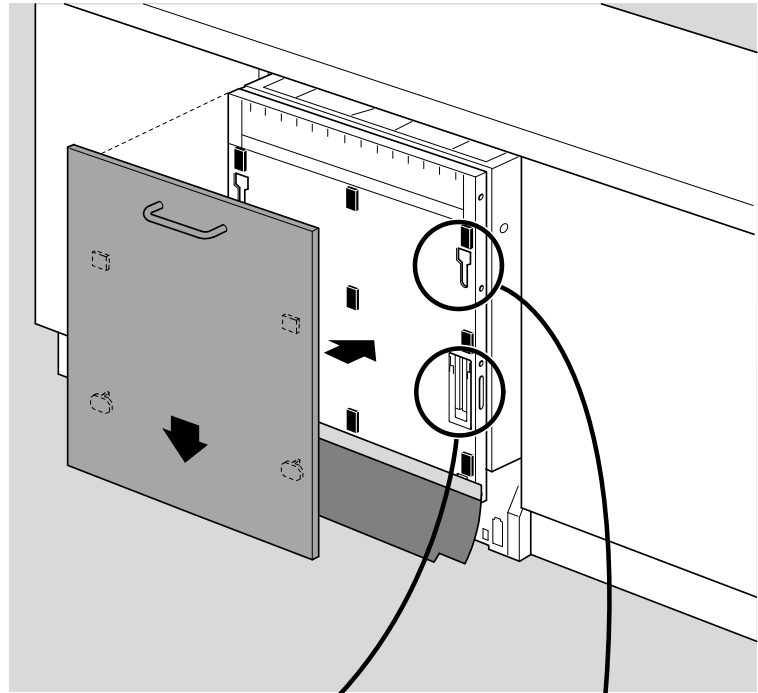
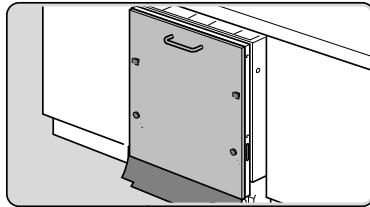
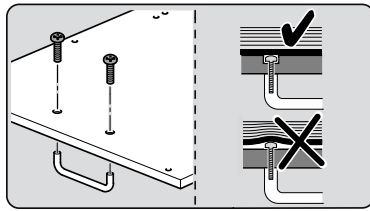

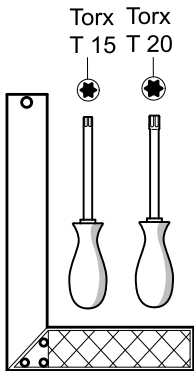
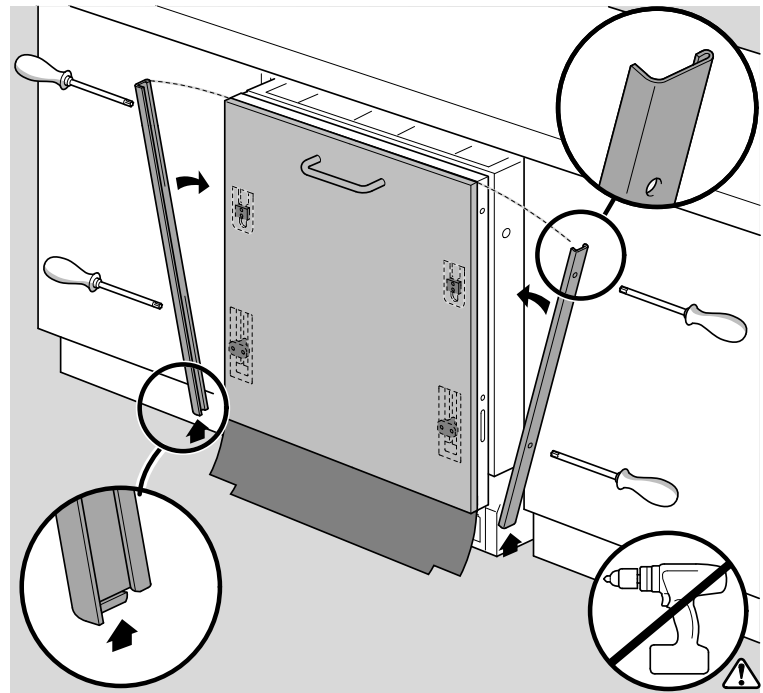
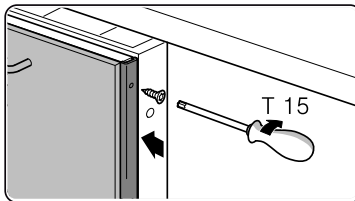
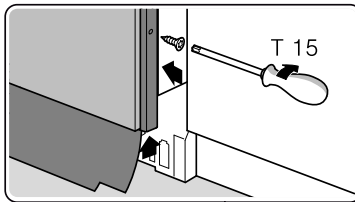
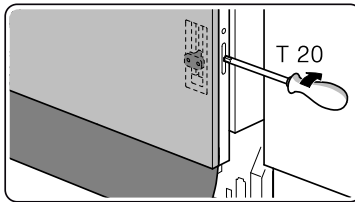
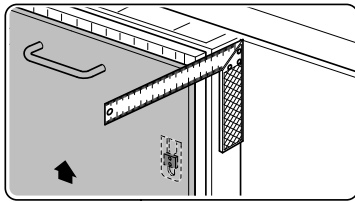

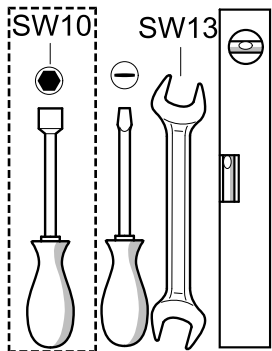
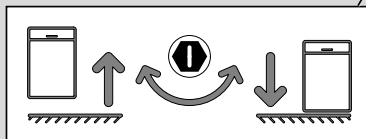
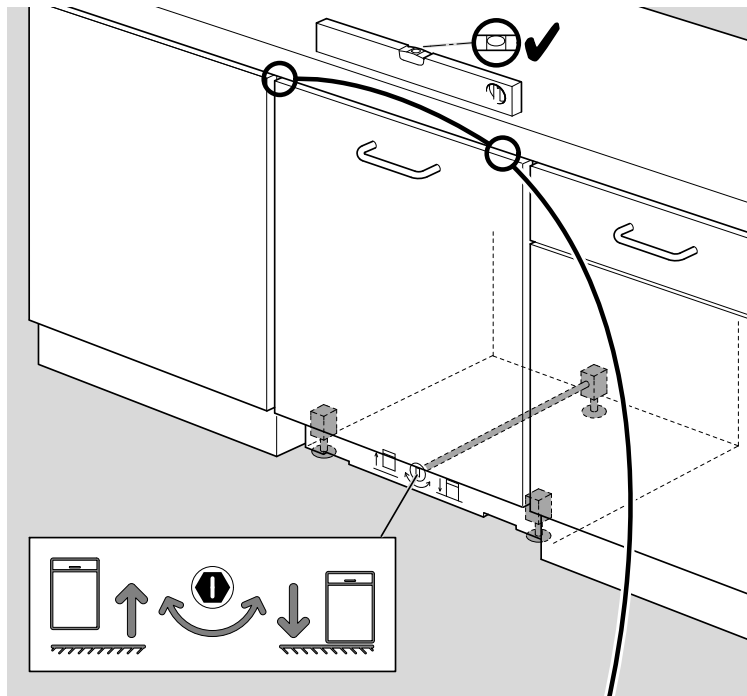
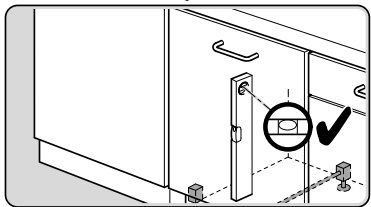
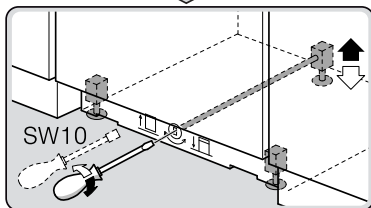
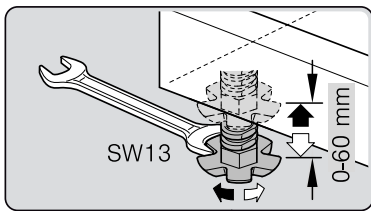

verspannen
brace
calar verticalement
Enrasar

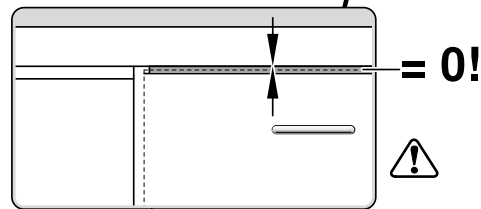

Ø4X30



Torx
T 20

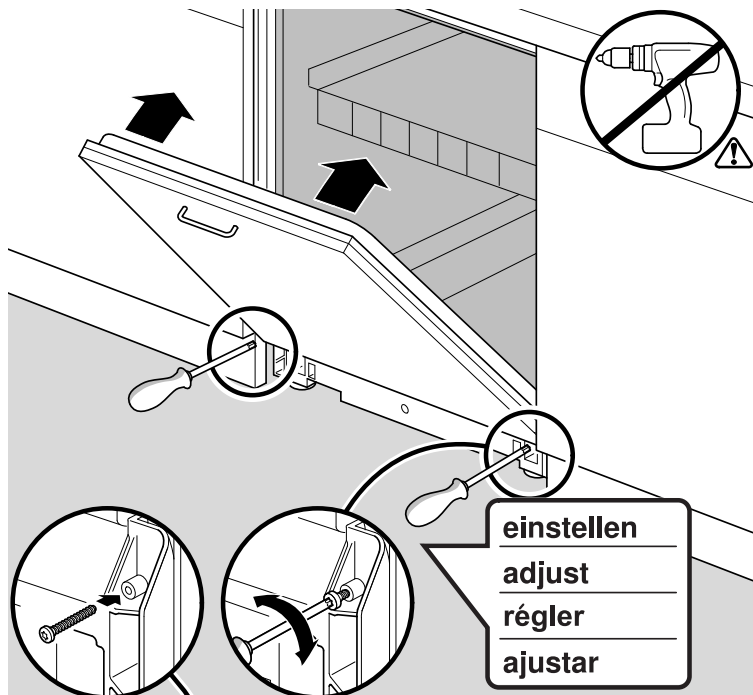
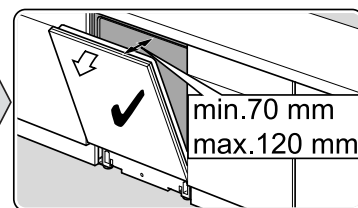
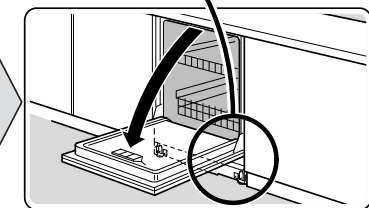
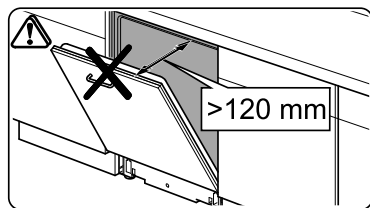
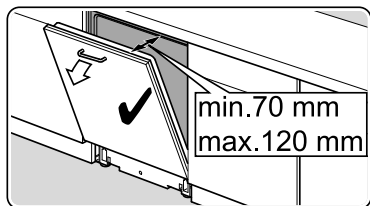

Ø4X36

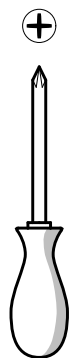
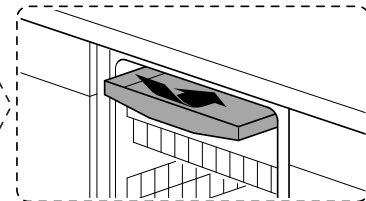
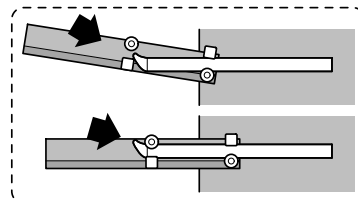
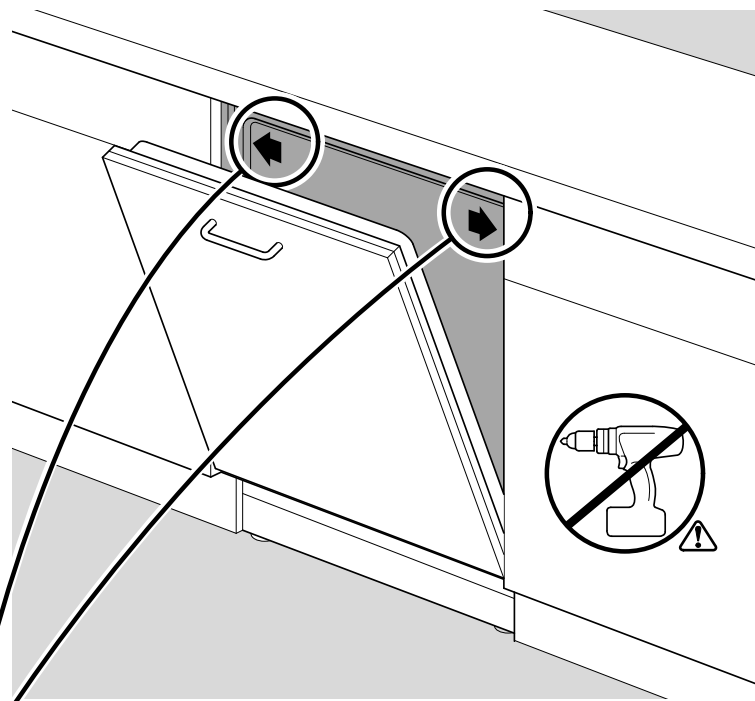
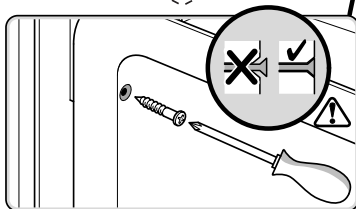
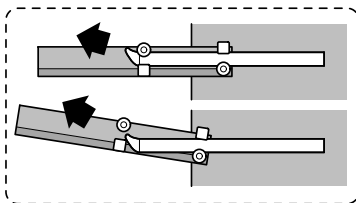
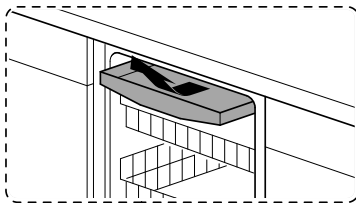
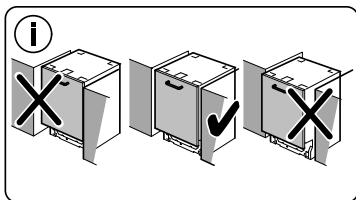
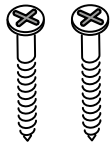

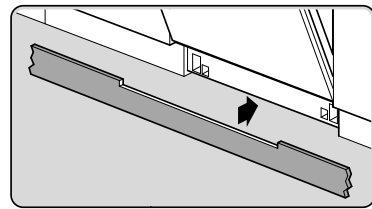
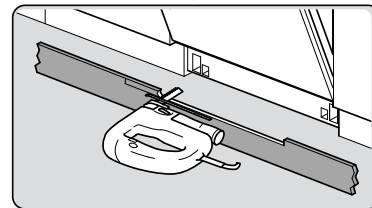
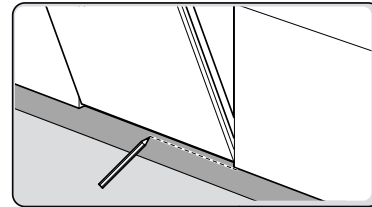
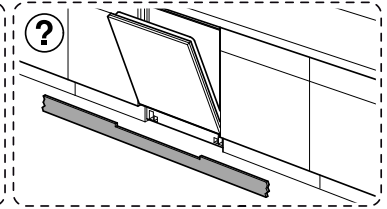
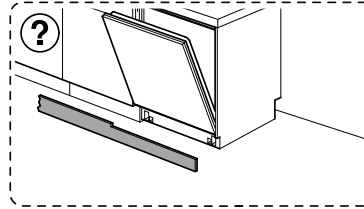
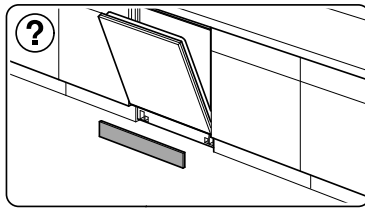
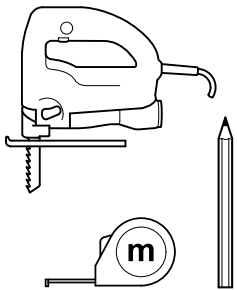

Ø4X15

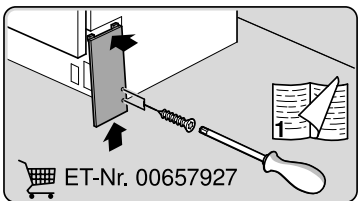
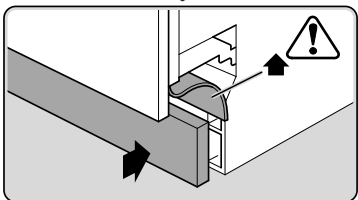
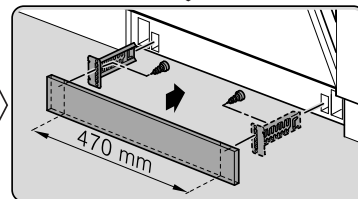
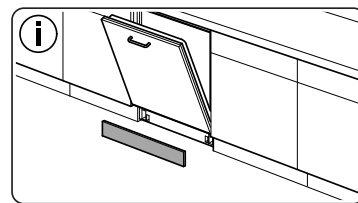
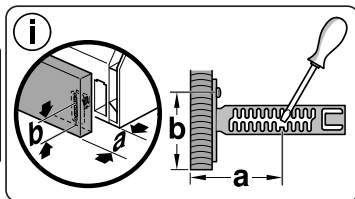
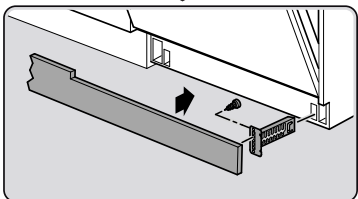
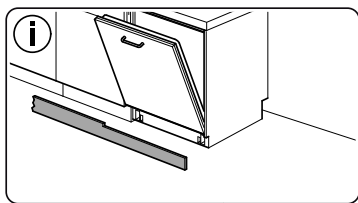
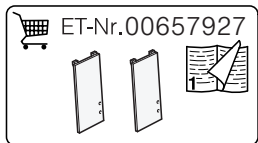
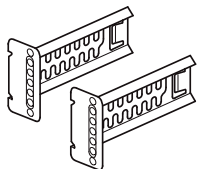

Torx
T 20

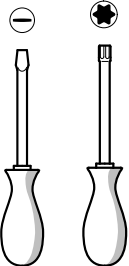

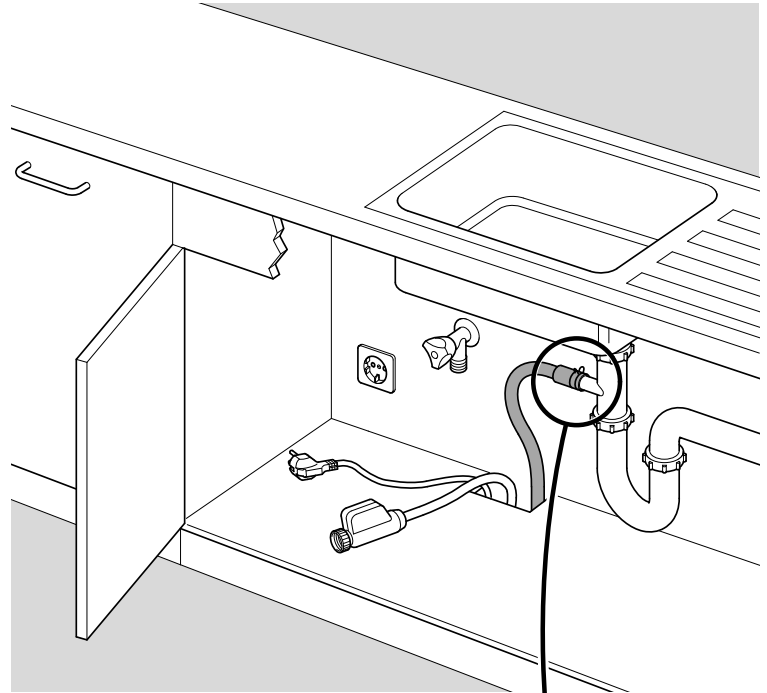
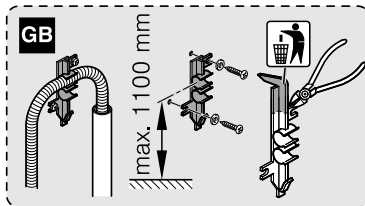
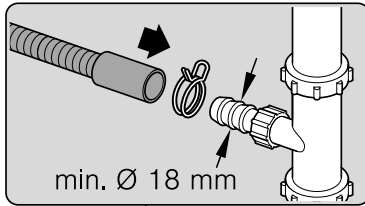
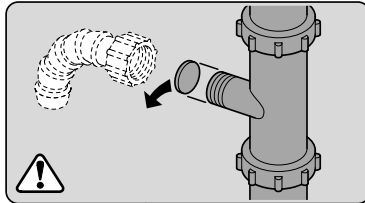
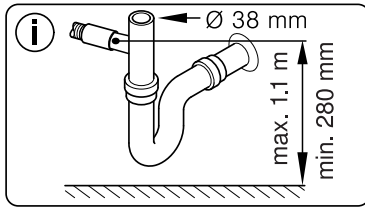
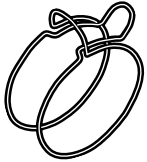

Dichtheit prüfen
Check for leaks
Verifiez l'étanchéité
Verificar la estanqueidad

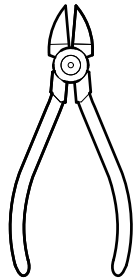
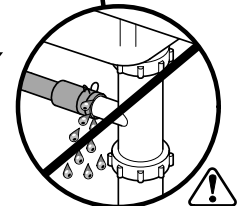

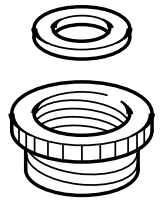

i

20,9 mm
(G 1/2")

0,05 - 1 MPa
(0,5 - 10 bar)
max. 60°C

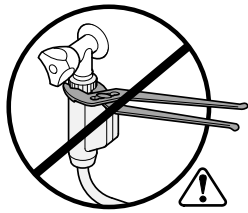

max. 10 Nm

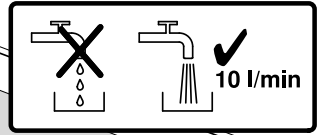
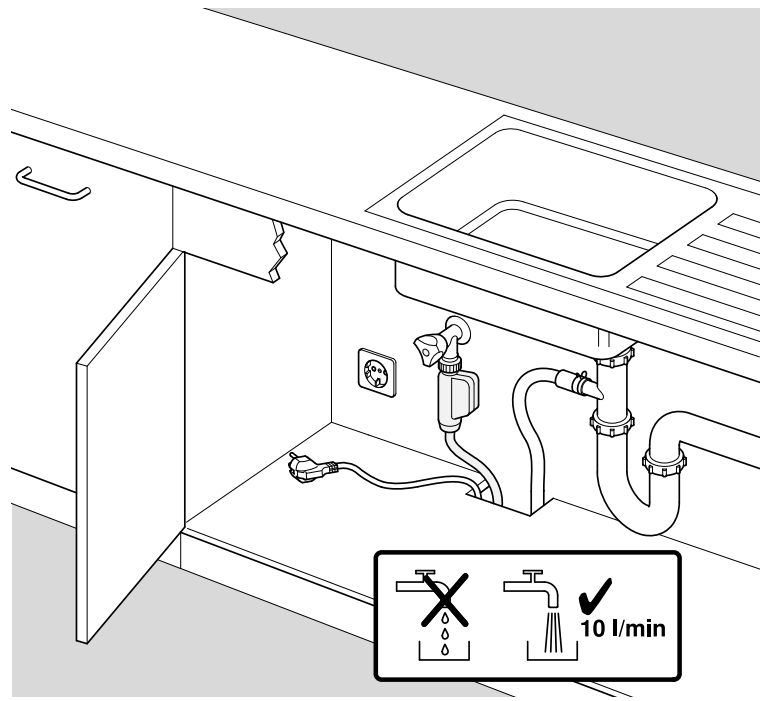

Dichtheit prüfen
Check for leaks
Verifiez l'étanchéité
Verificar la estanqueidad



