

9001800972

(030316) 642A\_SK\_86,5\_GS\_Türassi



- de** Montageanleitung
- sv** Installationsanvisningar
- no** Installasjonsveiledning

- fi** Asennusohjeet
- da** Installationsvejledning



- de** über den Kundendienst erhältlich
- sv** går att beställa via service
- no** fås hos kundeservice

- fi** saatavissa huoltopalvelusta
- da** Fås hos kundeservice

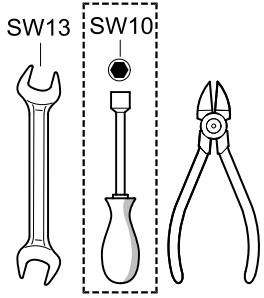
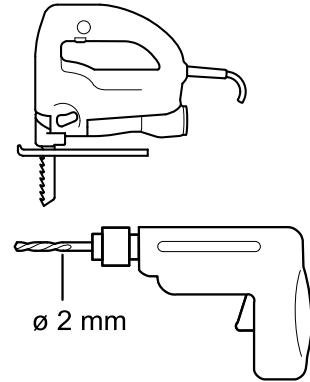
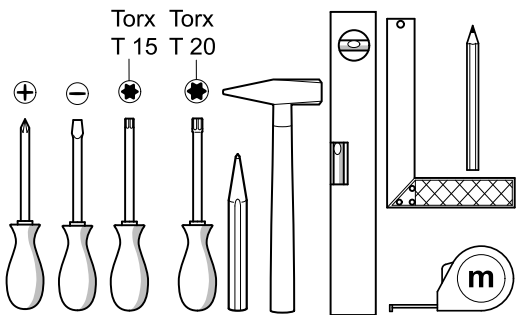
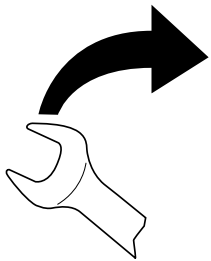
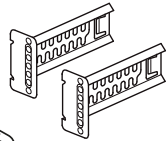
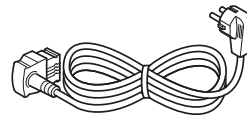
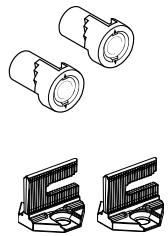
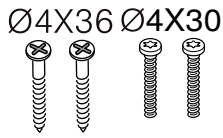
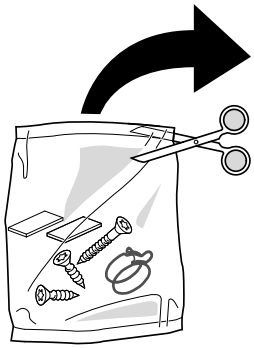

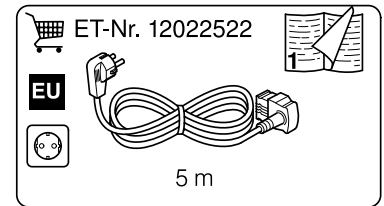
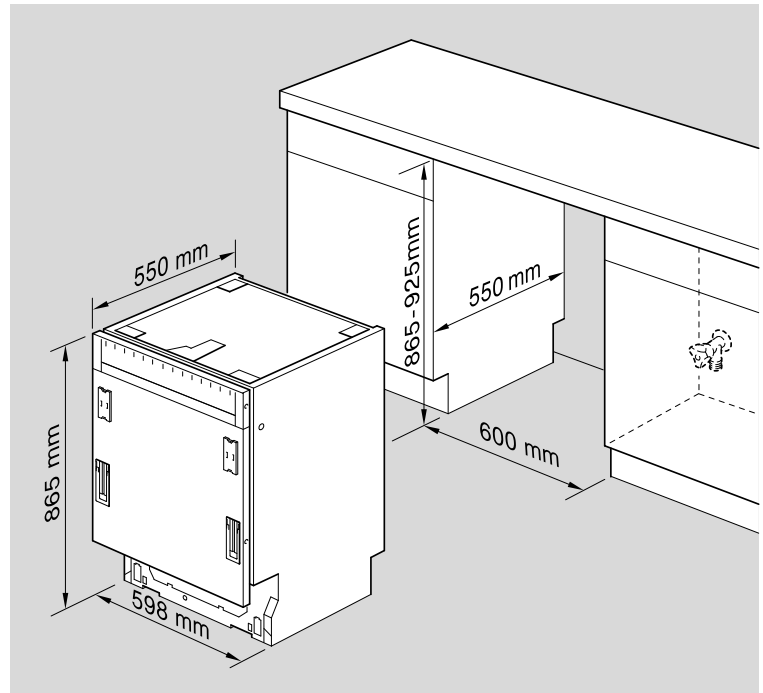
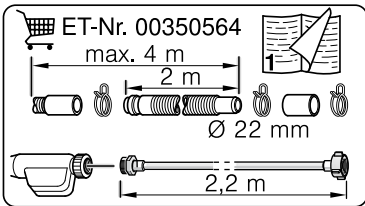
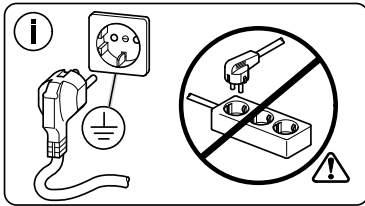
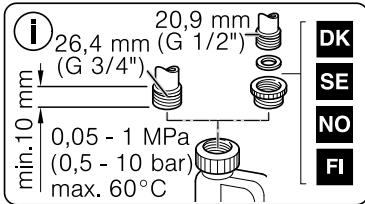
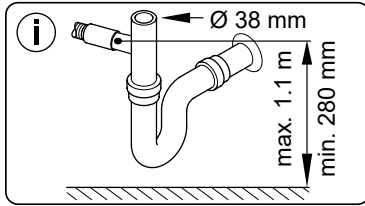

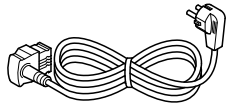

ET-Nr. 12022522

EU 5 m

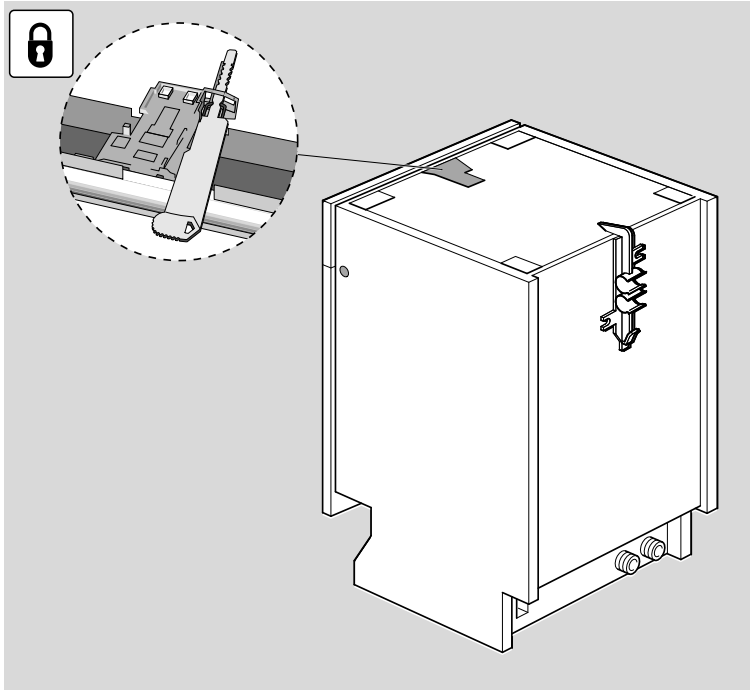
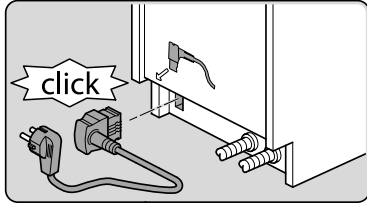
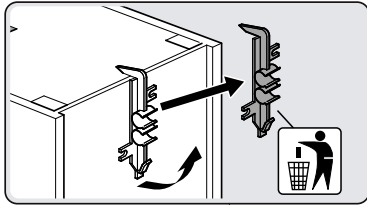

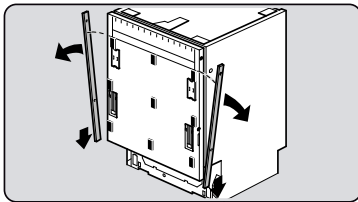
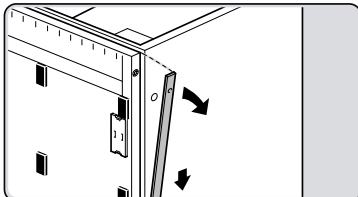
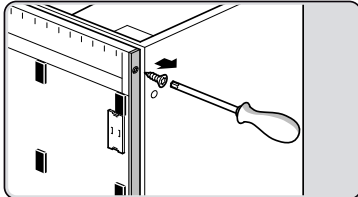
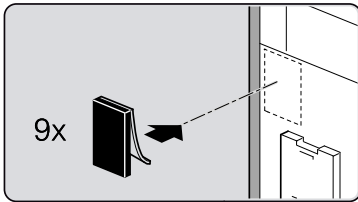
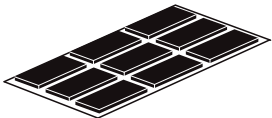

Torx  
T 15

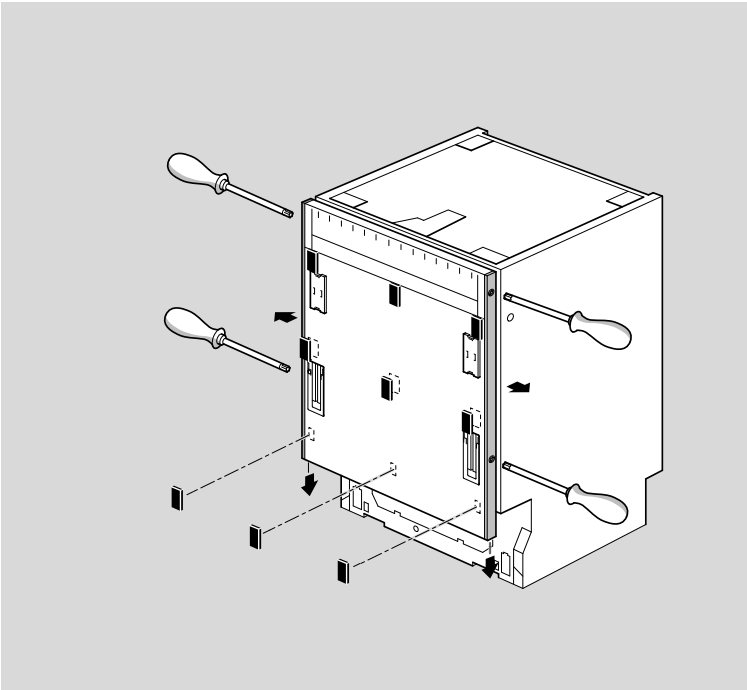

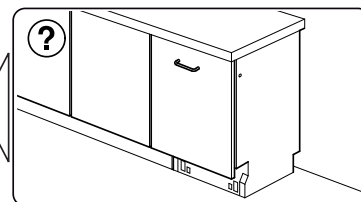
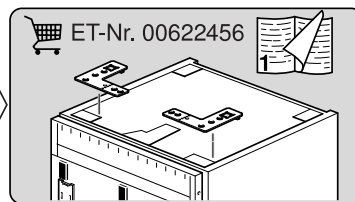
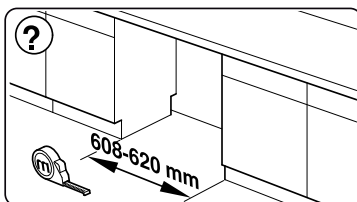
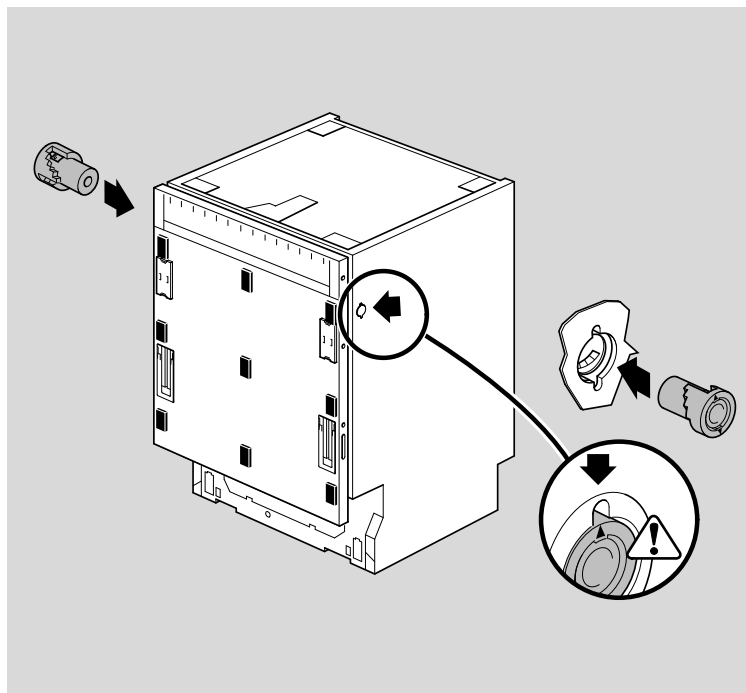
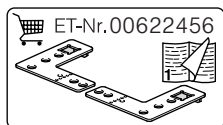
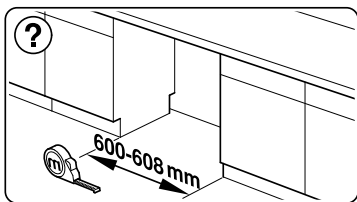
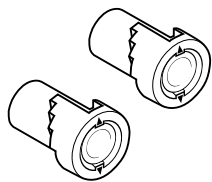

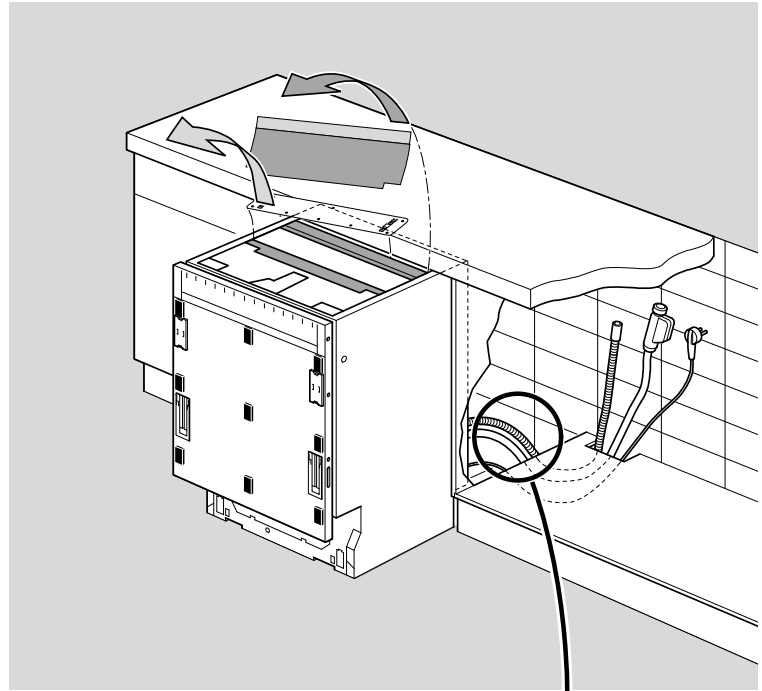
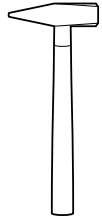
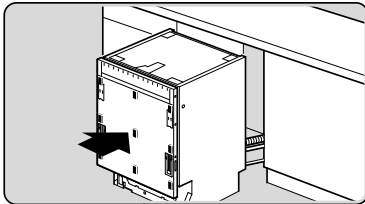
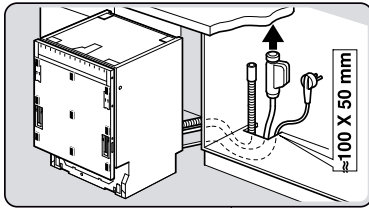
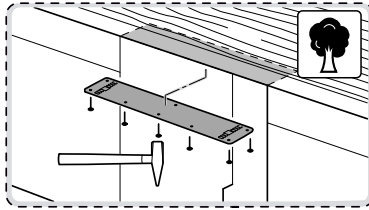
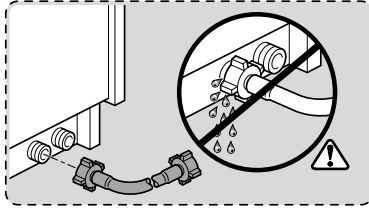
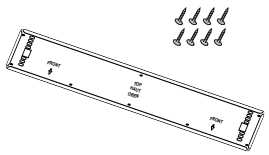

nicht einklemmen  
do not pinch  
ne pas coincer  
No doblar

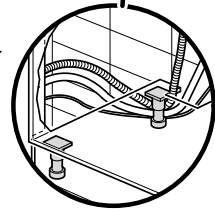

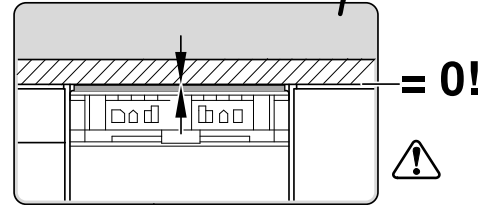
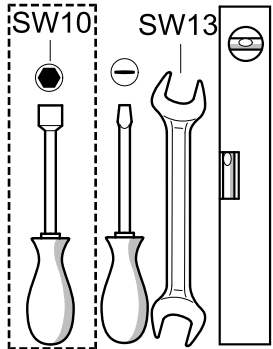
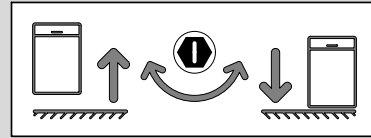
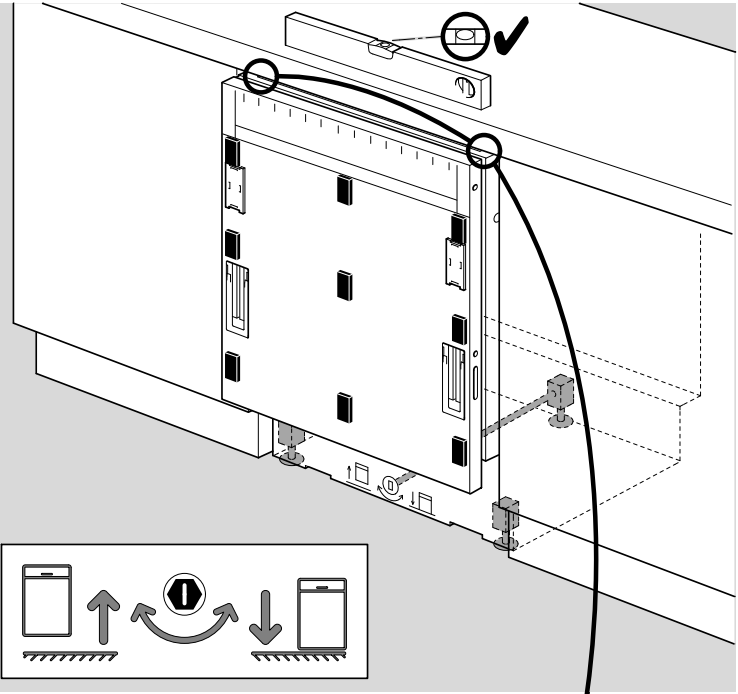
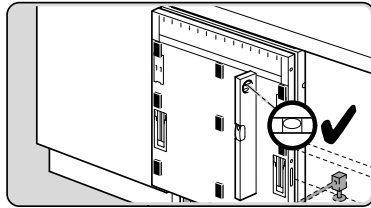
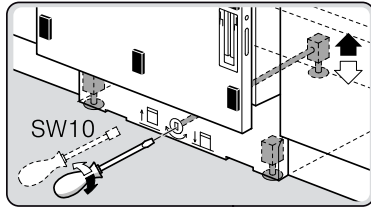
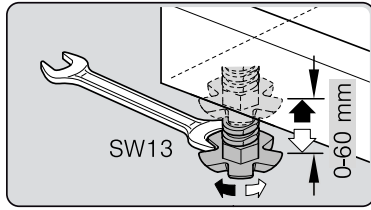



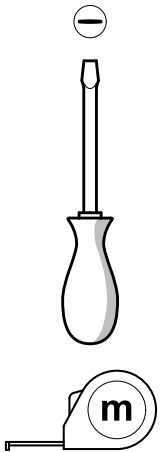
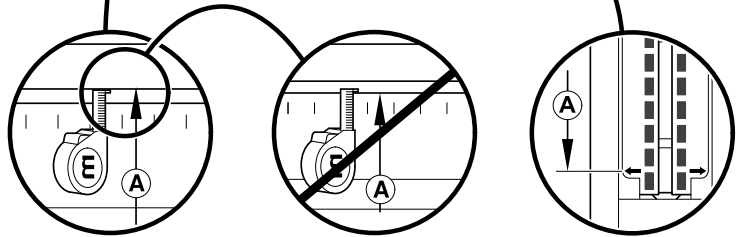
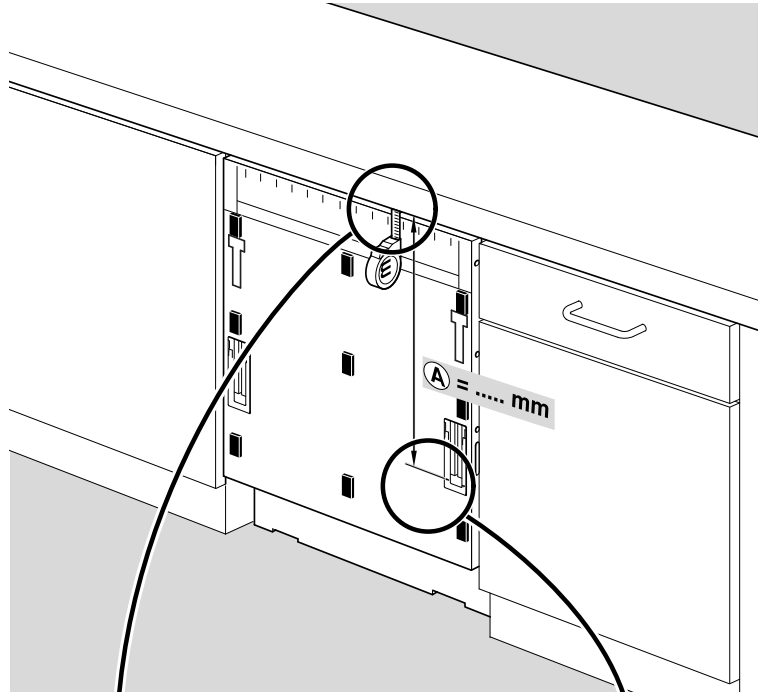
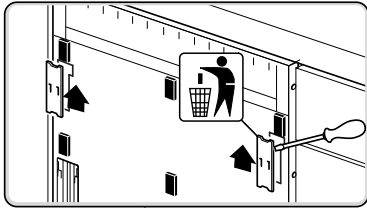

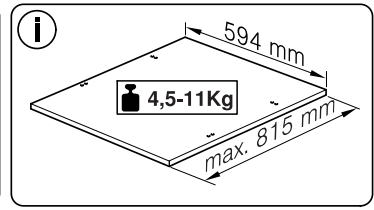
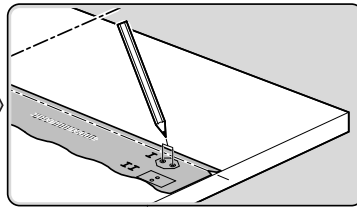
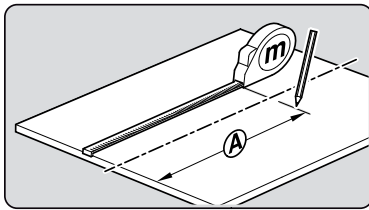
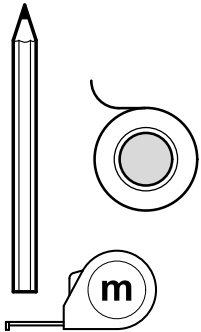
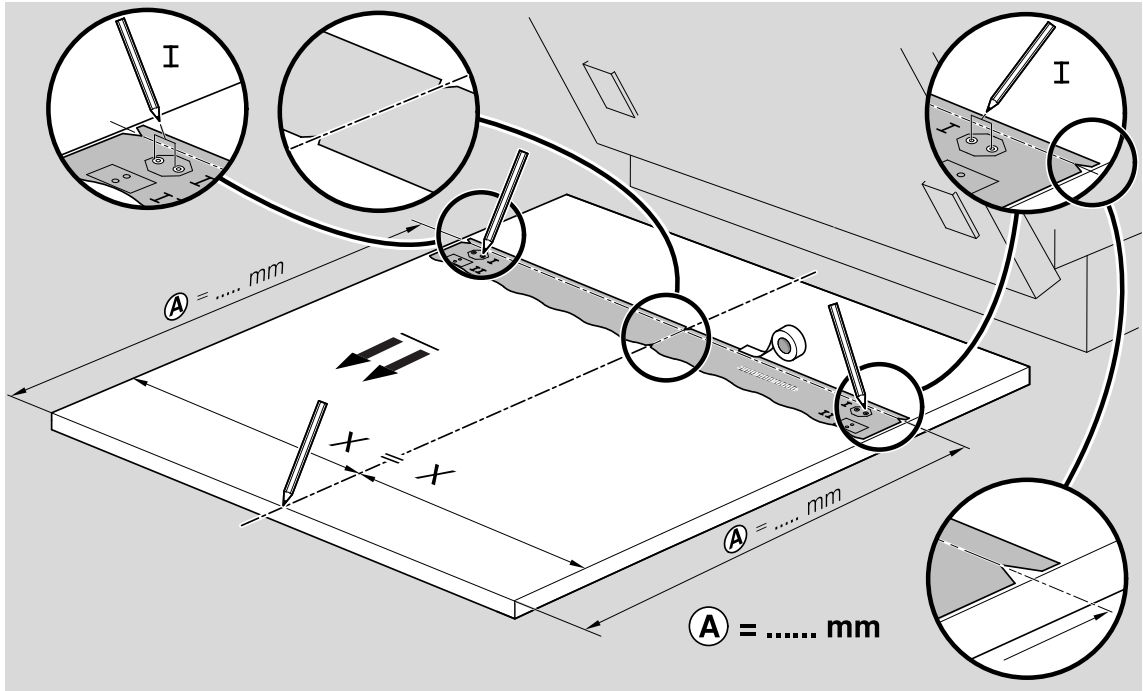
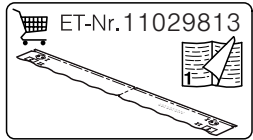
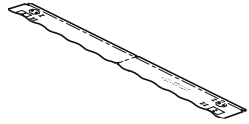

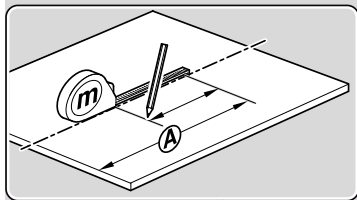
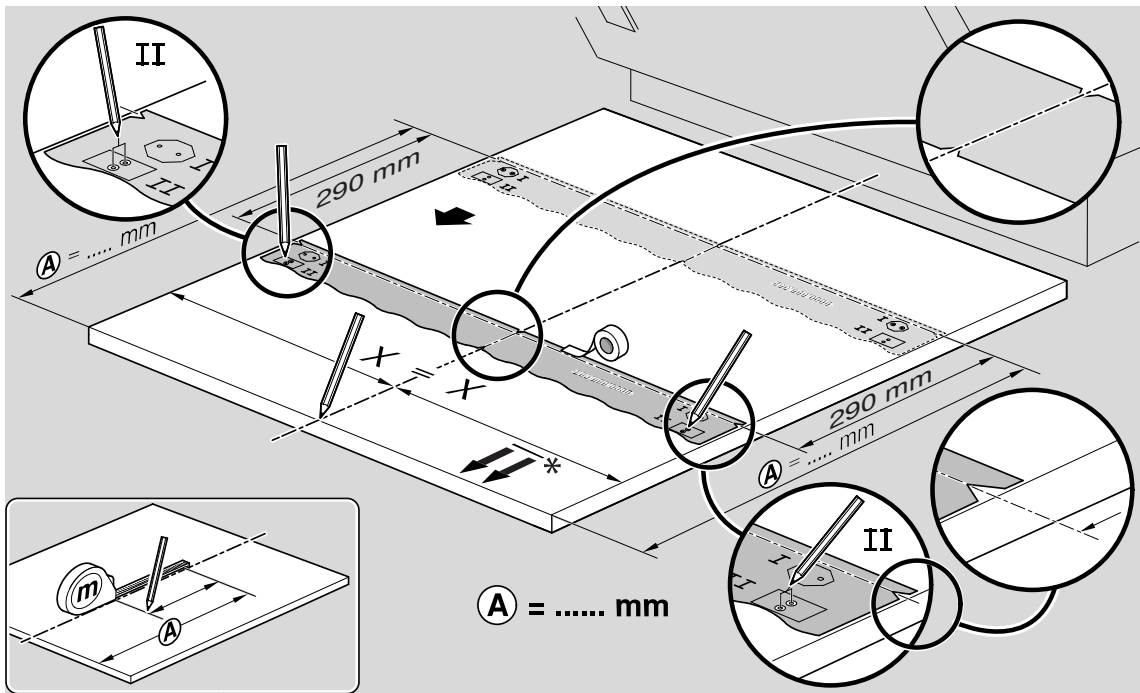
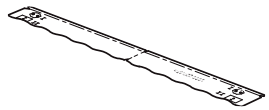

A = ..... mm

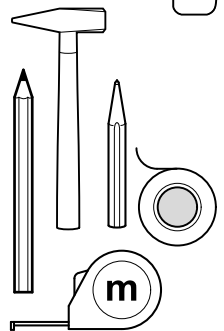
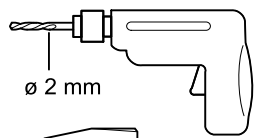
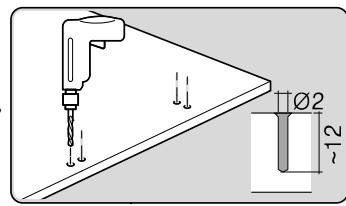
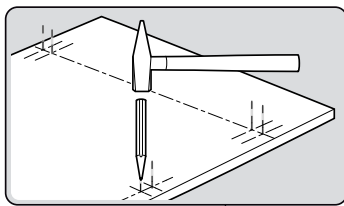
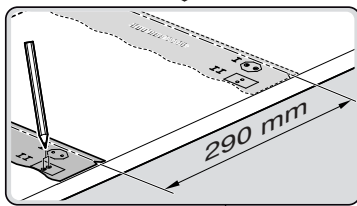

Ø4X15

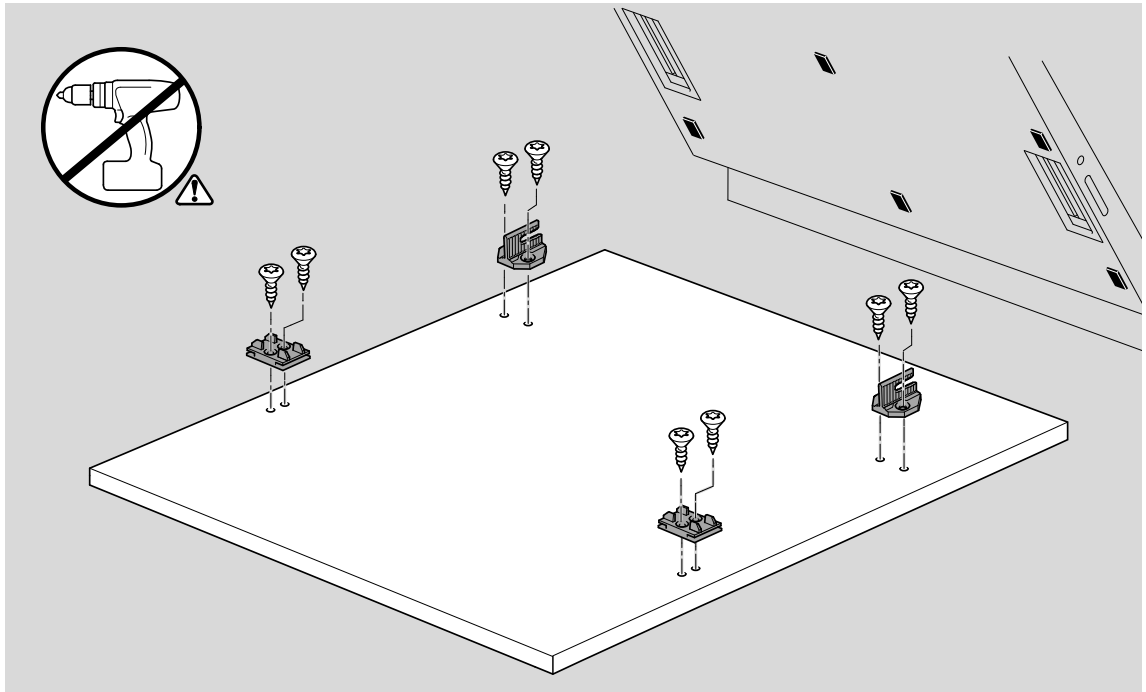
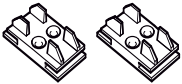
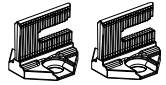

Torx  
T 20

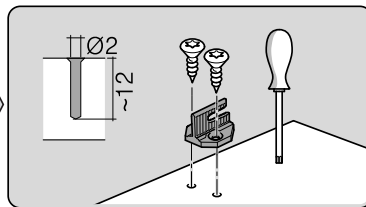
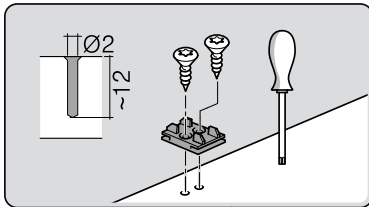

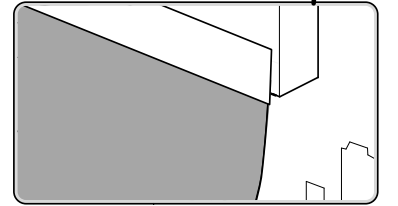
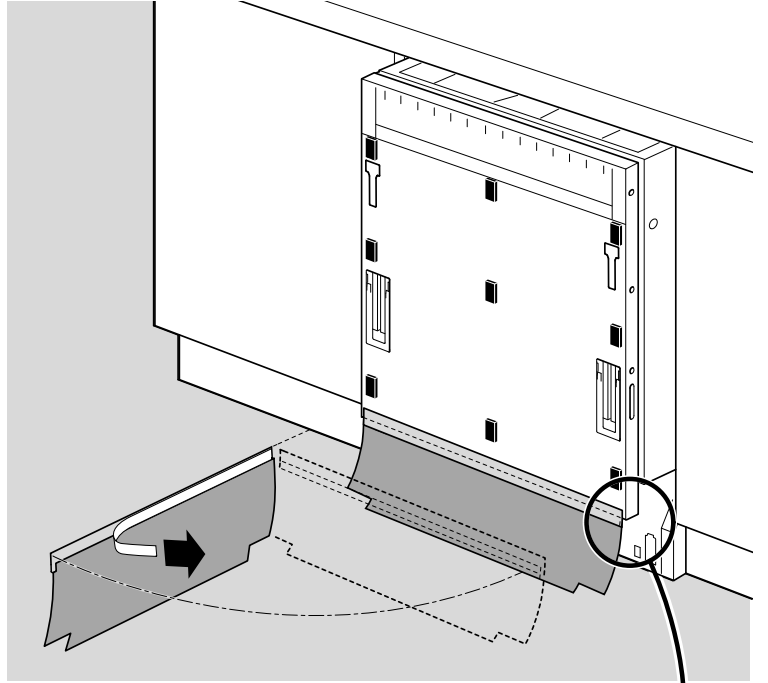
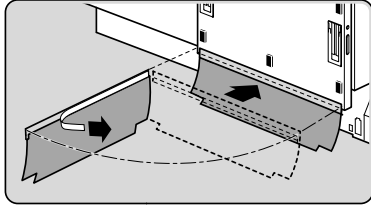
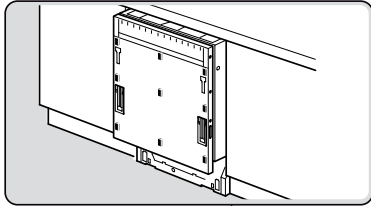
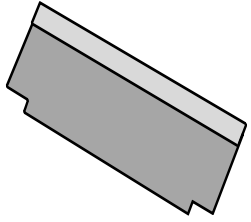

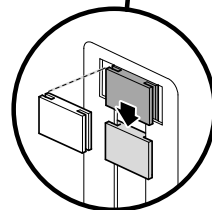
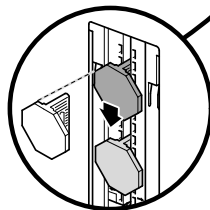
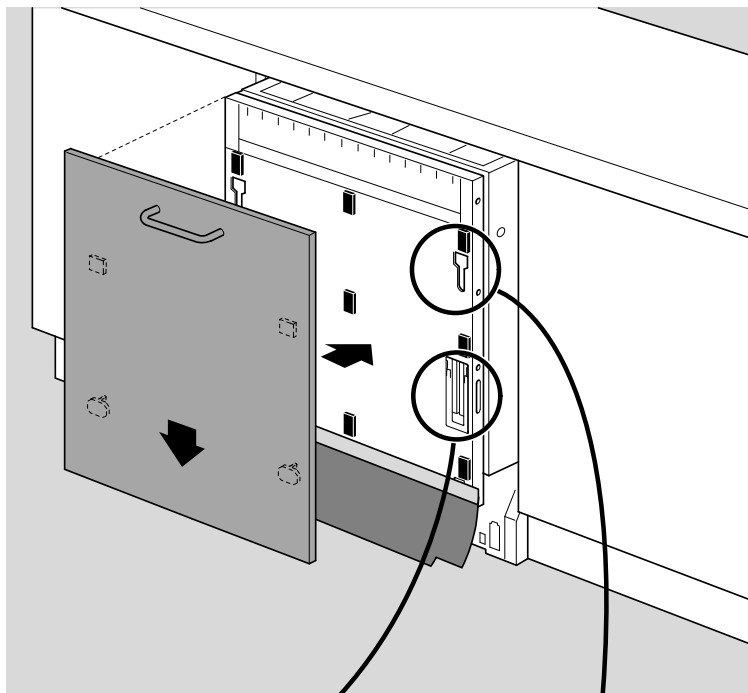
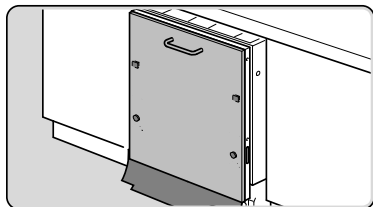
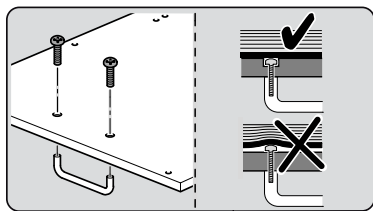

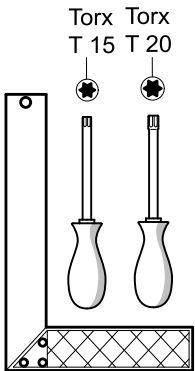
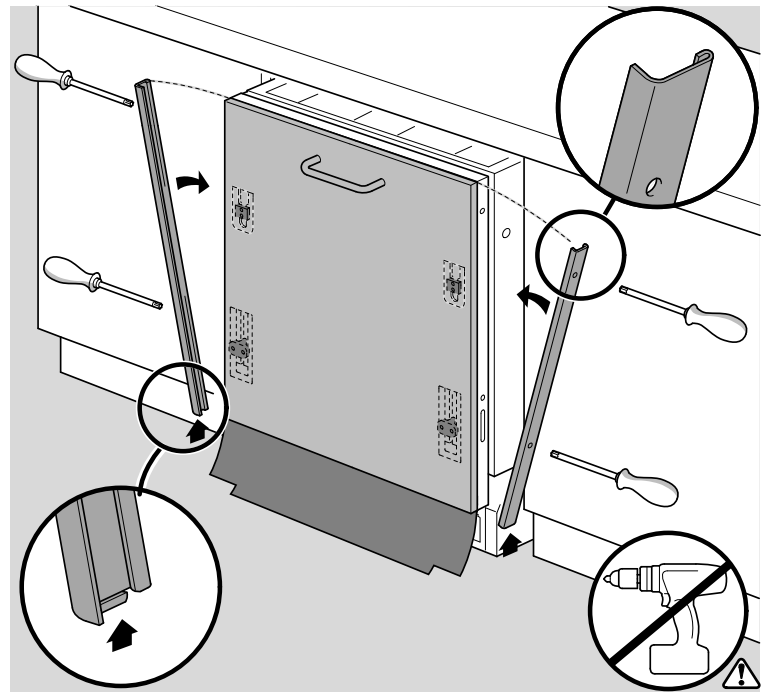
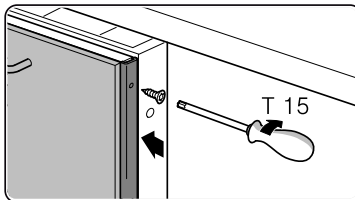
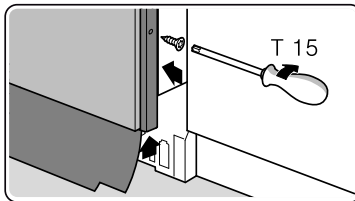
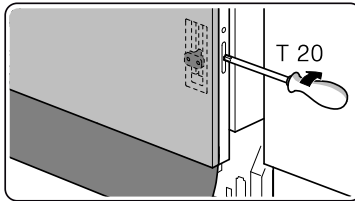
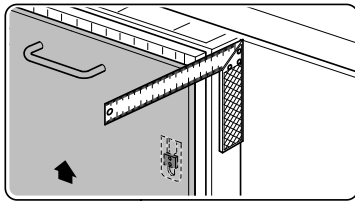

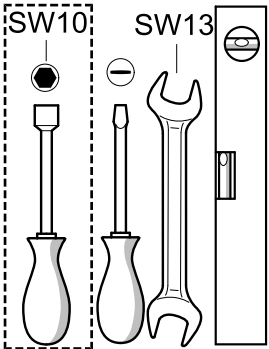
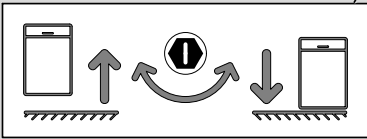
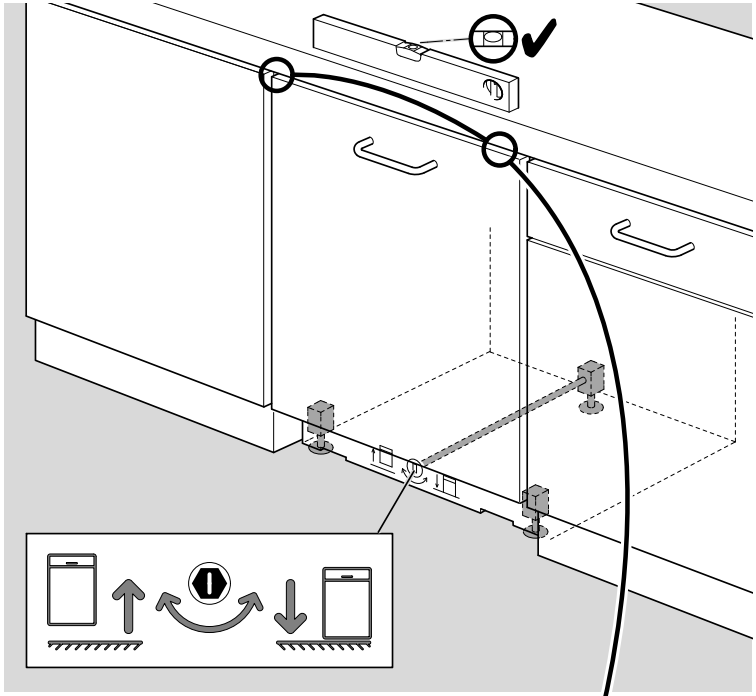
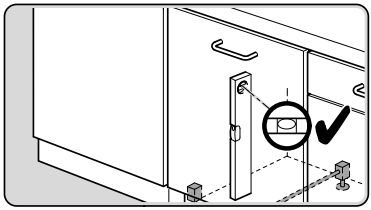
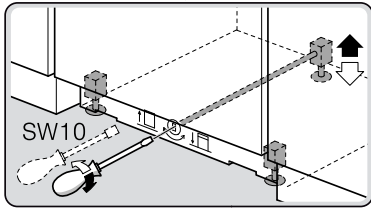
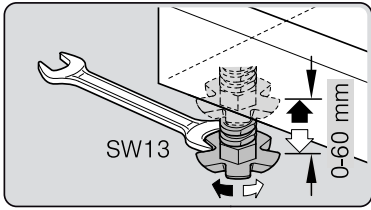

**verspannen**  
**brace**  
**calar verticalement**  
**Enrasar**

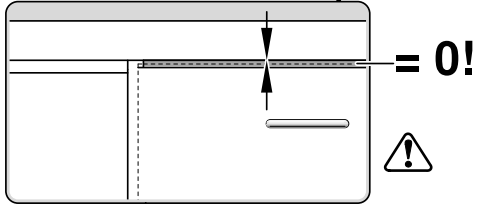



Ø4X30



Torx  
T 20

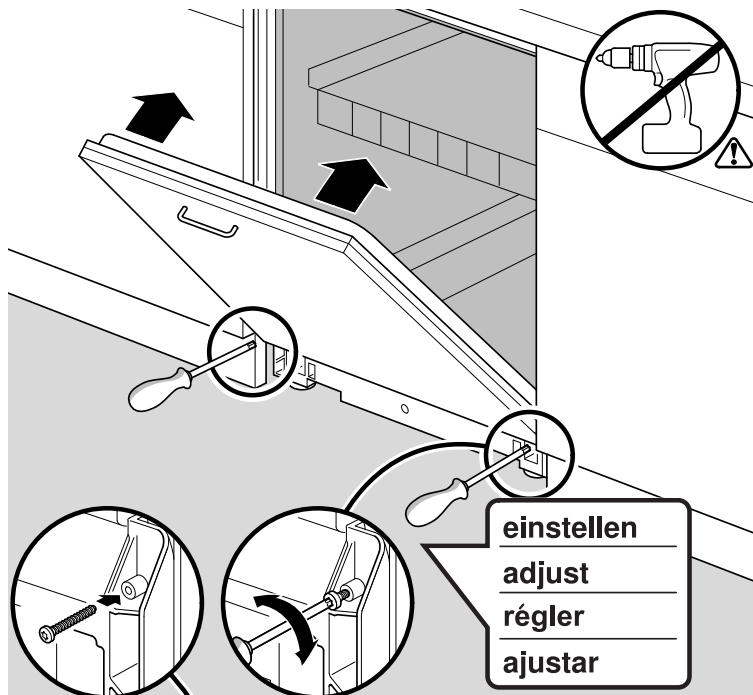
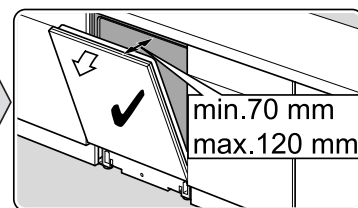
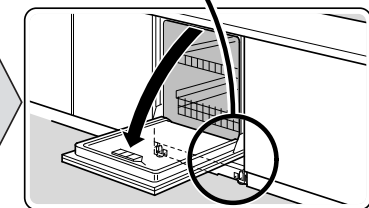
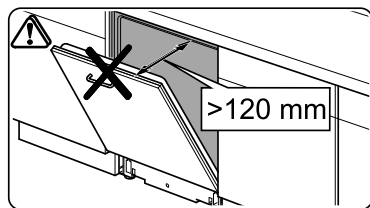
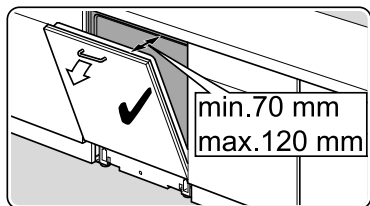

Ø4X36

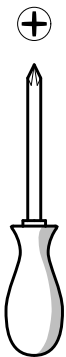
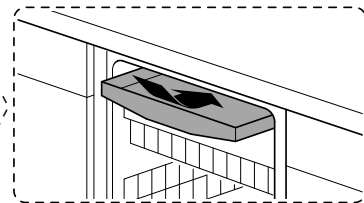
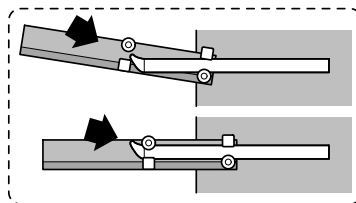
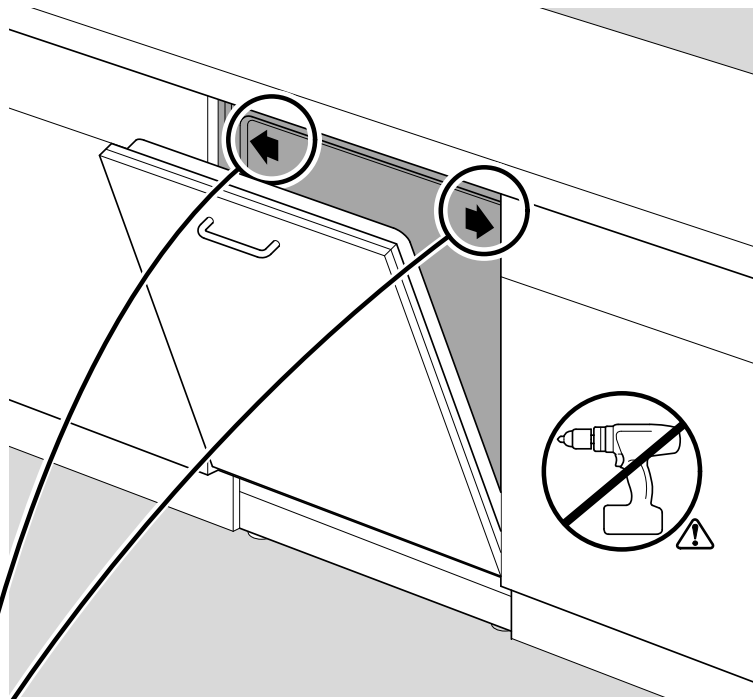
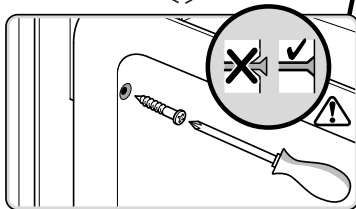
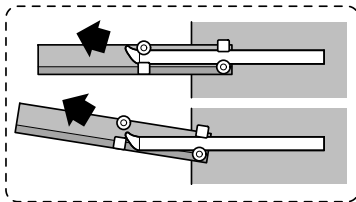
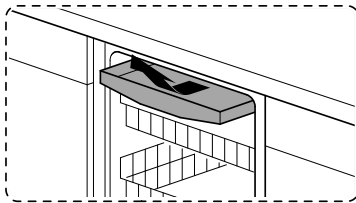
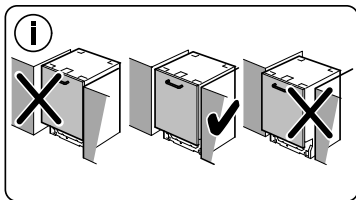
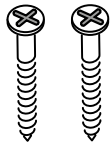

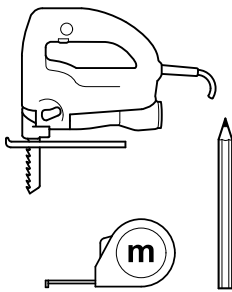
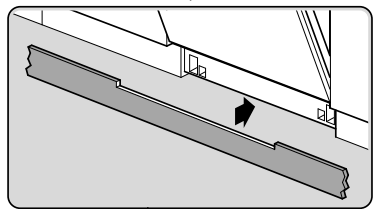
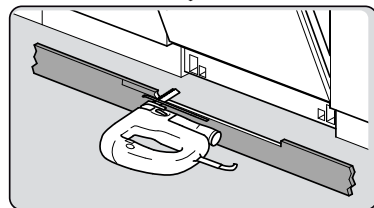
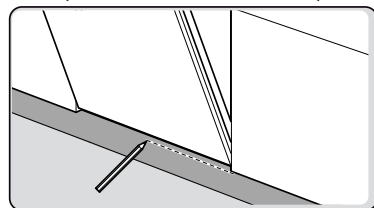
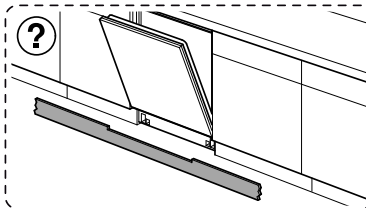
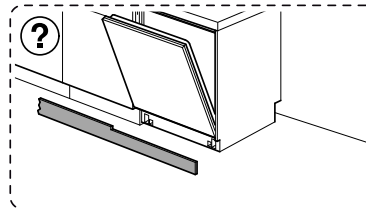
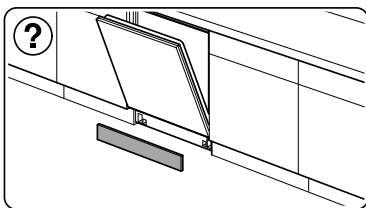

Ø4X15

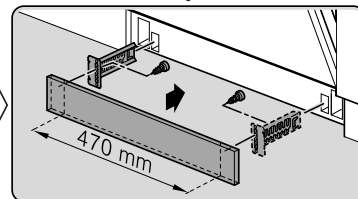
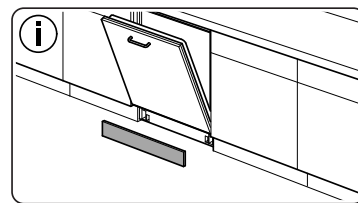
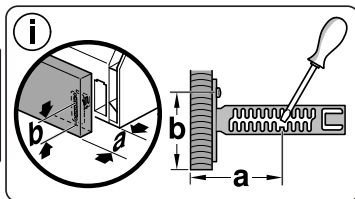
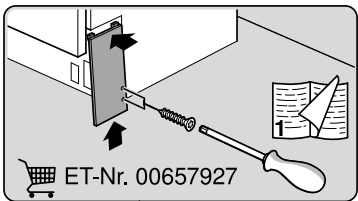
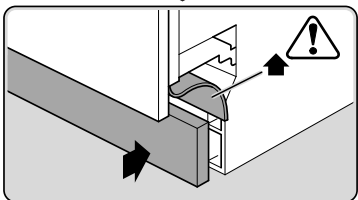
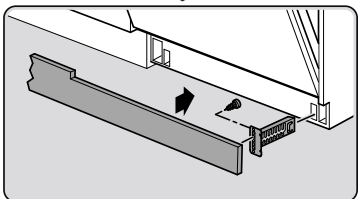
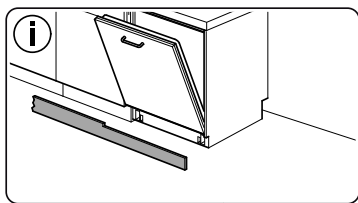
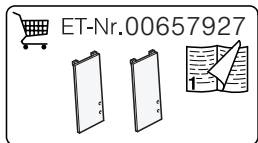
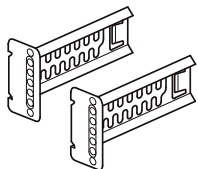

Torx  
T 20

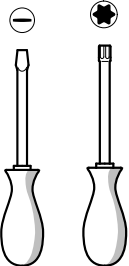

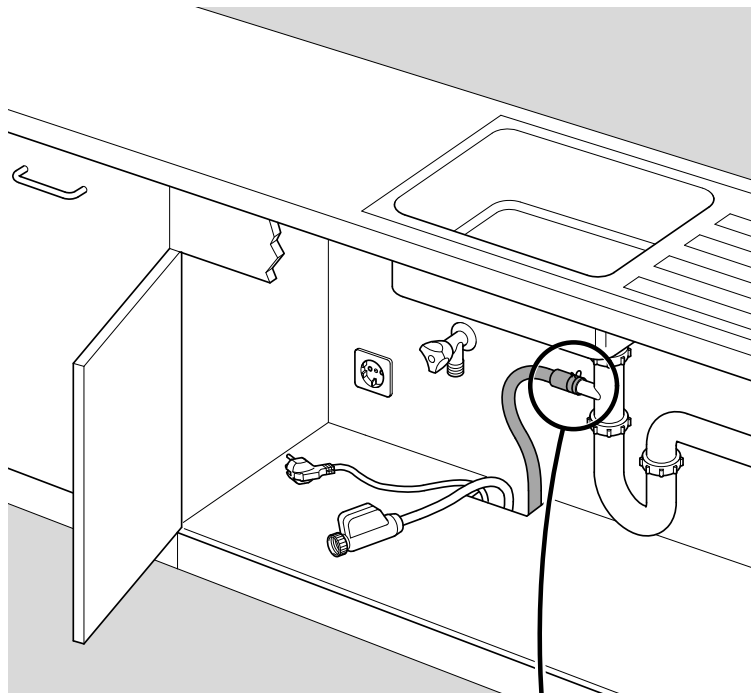
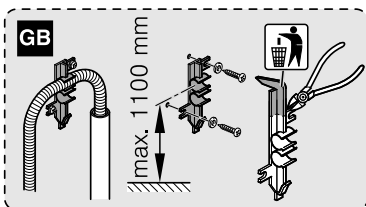
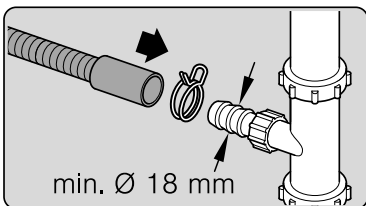
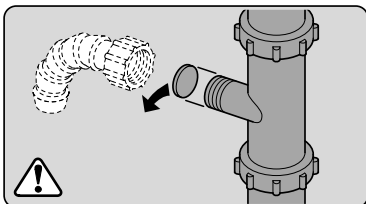
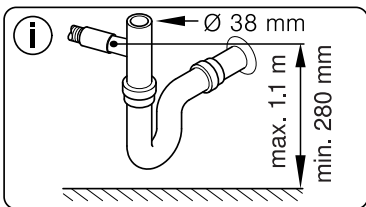

Dichtheit prüfen  
Check for leaks  
Verifiez l'étanchéité  
Verificar la estanqueidad

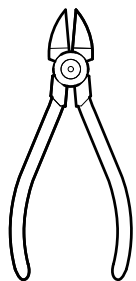
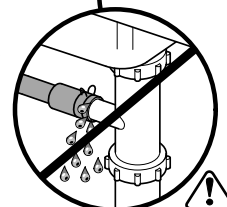

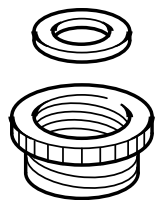

**i**

20,9 mm  
(G 1/2")

0,05 - 1 MPa  
(0,5 - 10 bar)  
max. 60°C

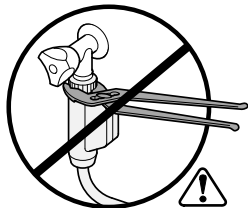

**max. 10 Nm**

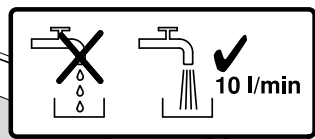
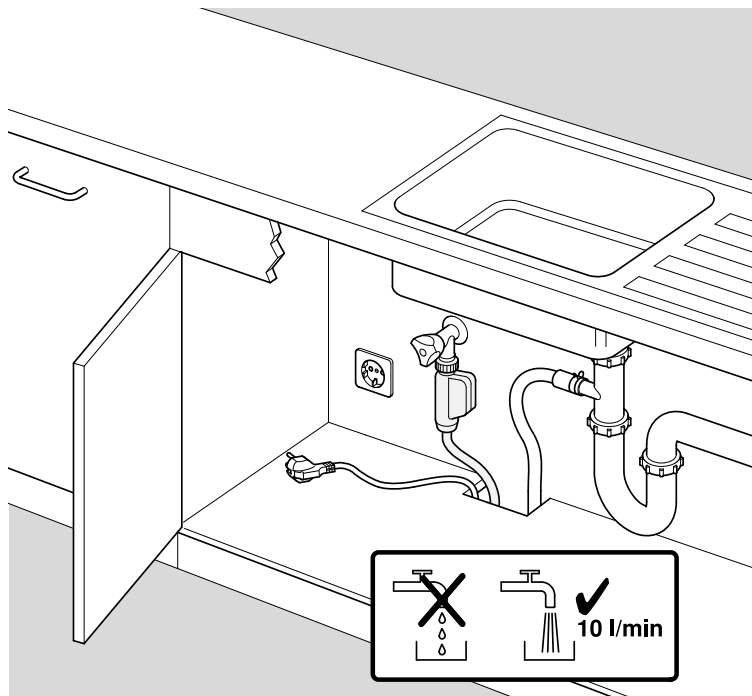

**Dichtheit prüfen**  
**Check for leaks**  
**Verifiez l'étanchéité**  
**Verificar la estanqueidad**



