

SIEMENS

BV830EN.1

Vacuum-sealing drawer



EN Information for Use

Siemens Home Appliances

Register your appliance on My Siemens and
discover exclusive services and offers.



Table of contents

1	Safety	2
2	Avoiding material damage	3
3	Environmental protection and saving energy	4
4	Familiarising yourself with your appliance	5
5	Accessories	6
6	Basic operation	6
7	Vacuum-sealing in the bag	6
8	Vacuum-sealing in the container	8
9	Drying	9
10	Cleaning and servicing	9
11	Troubleshooting	10
12	How it works	11
13	Disposal	13
14	Customer Service	14



1 Safety

Observe the following safety instructions.

1.1 General information

- Read this instruction manual carefully.
- Keep the instruction manual and the product information safe for future reference or for the next owner.
- Do not connect the appliance if it has been damaged in transit.

1.2 Intended use

This appliance is only intended to be fully fitted in a kitchen.

Only a licensed professional may connect appliances without plugs. Damage caused by incorrect connection is not covered under the warranty.

Only use this appliance:

- To vacuum-seal food in suitable vacuum-sealing bags or containers and to heat-seal film.
- in private households and in enclosed spaces in a domestic environment.
- up to an altitude of max. 4000 m above sea level.

1.3 Restriction on user group

This appliance may be used by children aged 8 or over and by people who have reduced physical, sensory or mental abilities or inadequate experience and/or knowledge, provided that they are supervised or have been instructed on how to use the appliance safely and have understood the resulting dangers.

Do not let children play with the appliance.

Children must not perform cleaning or user maintenance unless they are at least 15 years old and are being supervised.

Keep children under the age of 8 years away from the appliance and power cable.

1.4 Safe use

WARNING – Risk of burns!

The heat-sealing bar in the vacuum-sealing compartment becomes extremely hot if the appliance is used frequently and there are long heat-sealing times.

- ▶ Never touch the hot heat-sealing bar.
- ▶ Keep children at a safe distance.

WARNING – Risk of electric shock!

An ingress of moisture can cause an electric shock.

- ▶ Do not use steam- or high-pressure cleaners to clean the appliance.

If the appliance or the power cord is damaged, this is dangerous.

- ▶ Never operate a damaged appliance.
- ▶ Never pull on the power cord to unplug the appliance. Always unplug the appliance at the mains.
- ▶ If the appliance or the power cord is damaged, immediately unplug the power cord or switch off the fuse in the fuse box.
- ▶ Call customer services. → *Page 14*

Improper repairs are dangerous.

- ▶ Repairs to the appliance should only be carried out by trained specialist staff.
- ▶ Only use genuine spare parts when repairing the appliance.
- ▶ If the power cord of this appliance is damaged, it must be replaced by the manufacturer, the manufacturer's Customer Service or a similarly qualified person in order to prevent any risk.

⚠ WARNING – Risk of fire!

The heat-sealing bar in the vacuum-sealing compartment becomes extremely hot. Combustible vapours may ignite.

- ▶ Do not vacuum-seal any combustible liquids in the vacuum-sealing bag.
- ▶ Do not store any combustible materials and objects inside the appliance.

⚠ WARNING – Risk of injury!

The smallest cracks in the glass lid may result in it imploding when the vacuum is attached.

- ▶ Unplug the appliance from the mains or switch off the circuit breaker in the fuse box.
- ▶ Call after-sales service.

Any misuse of the vacuum-sealing drawer may lead to injury.

- ▶ Do not insert any hoses that are connected to the appliance into any body cavities.
- ▶ Do not vacuum-seal any living animals.

⚠ WARNING – Risk of harm to health!

During the vacuuming process, the vacuum-sealing compartment and the glass lid deform. The protective layer on the glass may be damaged and the glass lid may break.

- ▶ Screw-top jars, other hard containers, and non-deformable food that are vacuum-sealed in the compartment when the lid is closed must not come into contact with this lid.
- ▶ Hard containers and non-deformable food must not protrude over a maximum height of 80 mm.

⚠ WARNING – Risk of suffocation!

Children may put packaging material over their heads or wrap themselves up in it and suffocate.

- ▶ Keep packaging material away from children.
- ▶ Do not let children play with packaging material.

Children may breathe in or swallow small parts, causing them to suffocate.

- ▶ Keep small parts away from children.
- ▶ Do not let children play with small parts.

2 Avoiding material damage

ATTENTION!

Damage to the appliance may affect the safety considerably.

- ▶ Check the appliance for damage before each use.
- ▶ Check that the glass lid is intact.
- ▶ Never use a damaged appliance.
- ▶ Call after-sales service.

Using the appliance carelessly may cause damage to the appliance.

- ▶ Open and close the glass lid slowly.
- ▶ Do not place any objects on the glass lid.
- ▶ Do not use the appliance as a work surface or storage space.
- ▶ Do not let any objects fall onto the glass lid.
- ▶ Pull the drawer out completely during use.
- ▶ After use, close the drawer completely.

Foreign objects in the vacuum-sealing compartment damage the appliance.

- ▶ Before closing the glass lid, ensure that there is no debris in the vacuum-sealing compartment.

If the seal is sitting incorrectly or is damaged, this impairs the function of the appliance and may damage the appliance.

- ▶ Check that the seal is positioned correctly on the glass lid.

- ▶ The seal's contact surface must be clean and free from debris.
- ▶ Do not damage the seal with pointed or sharp objects.
- ▶ Never operate an appliance with a defective seal.
- ▶ If a seal is defective, contact after-sales service.

Using tools to open the glass lid damages the appliance.

- ▶ In the event of a power cut during the vacuum-sealing process, wait until the power supply is restored. The vacuum in the vacuum-sealing compartment is retained. Restart the vacuum-sealing process.

Escaping steam caused by boiling at excessive temperatures may lead to malfunctions.

- ▶ Only use bags that are suitable for vacuum-sealing food.
- ▶ Do not use any sales packages that have already been opened.
- ▶ Process the food that is to be vacuum-sealed at an output temperature of 1–8 °C.
- ▶ Do not vacuum-seal liquids in the vacuum-sealing bag at the highest level. Use vacuum-sealing level 2.
- ▶ Heat-seal the bag if you notice an intensified formation of bubbles.

3 Environmental protection and saving energy

3.1 Disposing of packaging

The packaging materials are environmentally compatible and can be recycled.

- ▶ Sort the individual components by type and dispose of them separately.

4 Familiarising yourself with your appliance

4.1 Function

During the vacuum-sealing process, air is pumped out of the vacuum-sealing compartment and the bag. This produces a high vacuum in the compartment. The higher the vacuum-sealing level, the less air remains in the compartment and the bag, and the higher the pressure difference to the environment.

Once the selected vacuum-sealing level has been reached, the heat-sealing bar is pressed against the silicone bar on the glass lid. During this, the bag is heat-sealed.

After a short cooling time, air flows back into the compartment, creating a loud noise. During this process, the bag suddenly contracts and encloses the food. The drawer's glass lid then opens.

4.2 Appliance

You can find an overview of the parts of your appliance here.

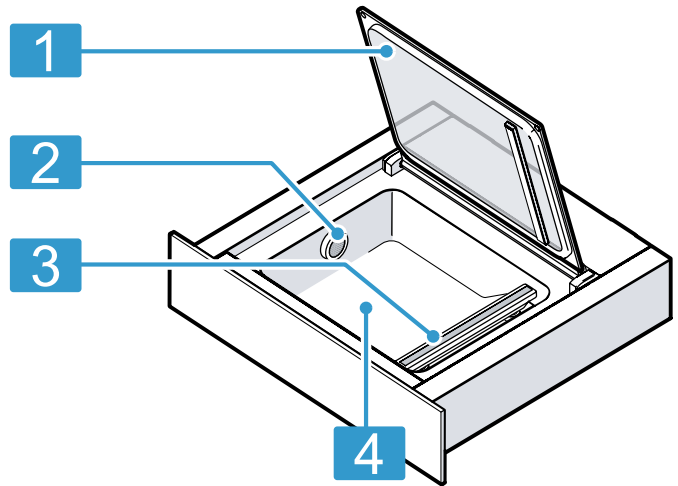

- | | |
|---|----------------------------|
| 1 | Glass lid |
| 2 | Air outlet |
| 3 | Heat-sealing bar |
| 4 | Vacuum-sealing compartment |

4.3 Controls

You can use the control panel to configure all functions of your appliance and to obtain information about the operating status.

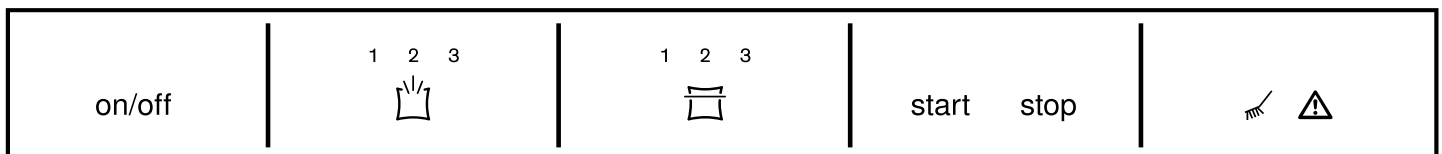

Sym- bol	Meaning	Explanation
on/off	Switching on Switching off	Switching on the appli- ance Switching off the appli- ance
	Vacuum-sealing level	Selecting the vacuum- sealing level
	Heat-sealing time	Selecting a heat-sealing time Heat-seal the vacuum- sealing bag early
start	Start	Starting the vacuum-seal- ing process
stop	Stop	Cancelling the vacuum- sealing process
	Dry	Drying the pump

Sym- bol	Meaning	Explanation
	Note	Referring to the fault table

4.4 Vacuum-sealing levels



The vacuum-sealing levels 1 to 3 achieve different degrees of vacuum.

When vacuum-sealing in the container, the degrees of vacuum are lower and therefore better suited for the particular food. When the external vacuum-sealing adaptor is attached, the vacuum-sealing drawer automatically detects which mode has just been activated.

Vacuum-sealing levels	1	2	3
Vacuum-sealing in the bag	80 %	95 %	99 %
Vacuum-sealing containers and bottles	50 %	75 %	90 %

5 Accessories

Use original accessories. These have been made especially for your appliance.

Accessories	Property	Use
External vacuum-sealing adapter		Vacuum-sealing containers or bottles.
Vacuum hose		Connect the external vacuum-sealing adapter to the vacuum-sealing container or the bottle adaptor.
Vacuum-sealing bag	180 x 280 mm (50 pcs) 240 x 350 mm (50 pcs)	

5.1 Other accessories

You can purchase other accessories from our after-sales service, specialist retailers or online. You will find a comprehensive range of products for your appliance in our brochures and online: www.siemens-home.bsh-group.com

Accessories vary from one appliance to another. When purchasing accessories, always quote the exact product number (E no.) of your appliance. You can find out which accessories are available for your appliance in our online shop or from our after-sales service.

Other accessories	Specialist retailer order number	After-sales service order number
Vacuum-sealing bag 180 x 280 mm (100 pcs)	HZ66D910	17000222
Vacuum-sealing bag 240 x 350 mm (100 pcs)	HZ66D920	17000223

6 Basic operation

6.1 Opening the appliance

1. Press on the centre of the drawer front.
 - ✓ The vacuum-sealing drawer pops out gently.
2. Reach in and pull out the vacuum-sealing drawer by the edge.

6.2 Closing the appliance

- ▶ Touch the middle of the vacuum-sealing drawer and push it back.

6.3 Switching on the appliance

- ▶ Press on/off.

6.4 Switching off the appliance

If you do not perform any actions on the appliance for 10 minutes, the appliance automatically switches off.

- ▶ Press on/off.

7 Vacuum-sealing in the bag

In the bag, vacuum-sealed food has a longer shelf life. You can therefore marinate the food or prepare for sous-vide cooking.

7.1 Suitable vacuum-sealing bags

Use suitable vacuum-sealing bags in order to achieve an optimum result.

Use the original vacuum-sealing bags that are enclosed with the appliance or can be ordered as accessories.

- These bags are suitable for a temperature range of $-40\text{ }^{\circ}\text{C}$ – $100\text{ }^{\circ}\text{C}$.
- The optimum heat-sealing time for these bags is level 2.
- The bags are suitable for use in the microwave. Pierce the bags before you heat them up in the microwave.

Only use bags that are suitable for vacuum-sealing food.

Commercially available products are different when it comes to the quality of the food, temperature resistance, material and surface. The heat-sealing time for the vacuum-sealing bag always depends on the material from which it is made.

- Thin-walled bag: Heat-sealing level 1
- Thicker material: Heat-sealing level 2 or higher

Use bags with a maximum width of 240 mm.

The length of the heat-sealing bar limits the size of the vacuum-sealing bag that can be used.

7.2 Filling the bag

Requirements

- The edge of the bag is clean and dry.
 - There is no food residue around the edge of the bag in the area around the seam.
1. Fold over the edge of the bag by approx. 3 cm.



2. Where possible, position the items of food in the vacuum-sealing bag next to each other.

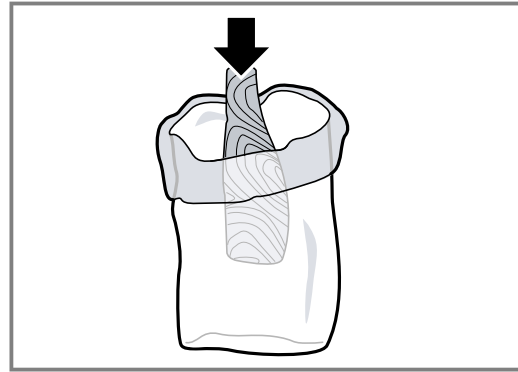

3. Fold the edge of the bag back.



Tip: To ensure that you can keep track of your bags and the food that is vacuum-sealed within them, make a note on the bag of the date of the vacuum-sealing along with the contents.

7.3 Vacuum-sealing in the bag

Requirement: The initial temperature of the food is ideally in the range of $1\text{--}8\text{ }^{\circ}\text{C}$.

1. Open the glass lid.
2. Place the vacuum-sealing bag in the compartment.
3. Make sure that the air outlet is not covered so that the pump can extract the air from the compartment.
4. To ensure that the heat-sealing seam is perfectly closed, make sure that the centre of the bag and the ends of the bag are lying flat on top of each other on the heat-sealing bar.
5. Make sure that the open end of the bag is protruding over the heat-sealing bar by approx. 3 cm but that it is not touching the lid seal.

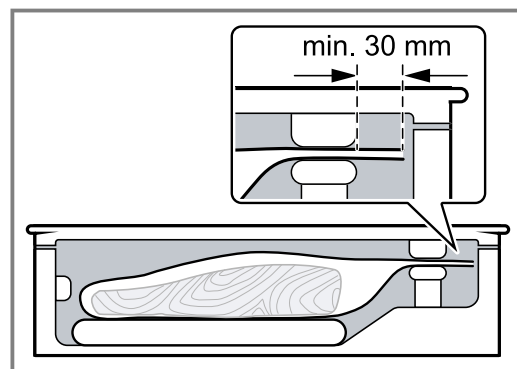

6. Elevate the bag if necessary using an item such as a chopping board to prevent the bag from sliding down.

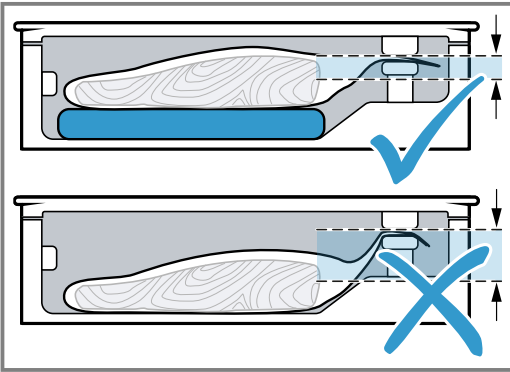

7. Touch to select the vacuum-sealing level.
 8. Touch to select the heat-sealing time.
 9. Tightly close the glass lid and hold it there for a few seconds.
 10. Touch to start the vacuum-sealing process.
 ✓ The vacuum-sealing process starts. The vacuum-sealing level indicators pulsate in blue one after the other until the selected value has been reached.
 ✓ The heat-sealing process starts. The vacuum-sealing level indicators pulsate in blue one after the other until the selected level has been reached.
 ✓ The vacuum-sealing process can take up to two minutes.
 ✓ At the end of the process, the compartment is ventilated. An audible signal sounds.
 11. Once the vacuum-sealing process is finished, open the glass lid.
 12. **WARNING – Risk of burns!**
 The heat-sealing bar in the vacuum-sealing compartment becomes extremely hot if the appliance is used frequently and there are long heat-sealing times.
 ▶ Never touch the hot heat-sealing bar.
 ▶ Keep children at a safe distance.
 Remove the heat-sealed vacuum-sealing bag from the compartment.
 13. After vacuum-sealing, check the heat-sealing seam on the bag.
 – Carefully pull the seam apart.

- If the seam does not stay together, select a higher heat-sealing level.
- If the seam is deformed, select a lower heat-sealing level or leave the appliance to cool down.

Note: If you vacuum-seal food in bags several times in succession, the heat-sealing bar becomes increasingly hotter. This may impair the quality of the heat-sealing seam. After several vacuum-sealing processes, select a lower heat-sealing time or leave the appliance to cool for approx. two minutes between the processes.

7.4 Early heat-sealing

Use this function if you only want to pack your delicate food in a bag so that it is air-tight, without the contents sitting too tightly against the bag.

1. To stop the vacuum-sealing process and heat-seal the bag early, touch .
- ✓ The appliance displays the vacuum-sealing level until it is reached.
- ✓ At the end of the process, the compartment is ventilated.
- ✓ An audible signal sounds.
2. Open the glass lid.
3. Remove the heat-sealed vacuum-sealing bag from the compartment.

Note: To heat-seal the bag, the vacuum-sealing drawer requires a specific degree of vacuum. If you touch first, the vacuum-sealing drawer pumps air out of the compartment until this degree has been reached. The bag is then heat-sealed.

7.5 Cancelling the vacuum-sealing process in the bag

1. To cancel the vacuum-sealing process early, touch .
- ✓ The appliance displays the vacuum-sealing level until it is reached.
- ✓ The bag is not heat-sealed.
- ✓ The lid opens slightly and the compartment is ventilated.
- ✓ An audible signal sounds.
2. Remove the vacuum-sealing bag from the compartment.

8 Vacuum-sealing in the container

In the container, vacuum-sealed food has a longer shelf life.



8.1 Vacuum-sealing in the container

Vacuum-seal the food in a suitable vacuum-sealing container in order to preserve the food for longer.

1. Open the glass lid.
2. Plug the vacuuming adaptor into the air outlet.

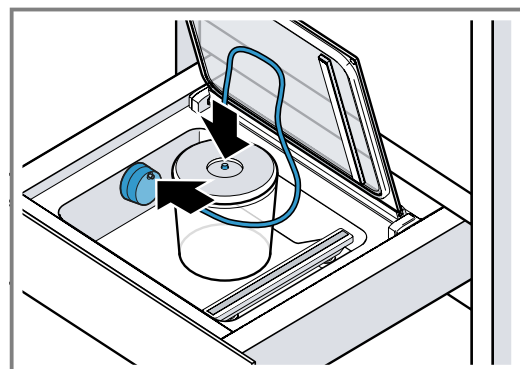
3. Secure the hose to the vacuuming adaptor and the vacuum-sealing container.



4. Touch  to select the vacuum-sealing level.
5. Touch  to start the vacuum-sealing process.
- ✓ The vacuum-sealing process starts. The vacuum-sealing level indicators pulsate in blue one after the other until the selected value has been reached.
- ✓ The vacuum-sealing process can take up to two minutes.
- ✓ The vacuum-sealing level that has been reached lights up and an audible signal sounds.
6. Detach the hose from the container and the external vacuuming adaptor.

Note: If larger bubbles form, cancel the vacuum-sealing process. → Page 9

8.2 Suitable vacuum-sealing containers

Use suitable vacuum-sealing containers in order to achieve an optimal result.

Only use containers that are suitable for vacuum-sealing food.

Commercially available products are different when it comes to the quality of the food and the material.

The vacuum hose attached to this appliance has an internal diameter of 3 mm.

You may need an adapter for your container so that the hose fits. These adaptors are often already included with the vacuum-sealing containers.



8.3 Cancelling the vacuum-sealing in the container

1. To cancel the vacuum-sealing process early, touch .
- ✓ The appliance displays the vacuum-sealing level until it is reached.
2. Detach the hose from the container and the external vacuuming adaptor.

9 Drying





When vacuum-sealing food, the smallest volume of water gets into the vacuum pump system.

This effect is exacerbated when you are vacuum-sealing liquids or extremely moist food. For this reason, the appliance comes with a drying function, which further removes any liquid that collects in the pump.

- If the  symbol lights up white, it is advisable to run a drying cycle. However, at this point, you can continue to use the appliance as normal if you wish.
- If the  symbol lights up red, you must run a drying cycle.

9.1 Starting drying

Note: You can close the vacuum-sealing drawer while drying is in progress.

1. Tightly close the glass lid and hold it there.
2. Touch .
- ✓ The drying starts and takes between 5 and 30 minutes.
- ✓ During the procedure,  pulsates in blue.
- ✓ At the end of the process, the compartment is ventilated and an audible signal sounds.
- ✓ You can now open the glass lid.
3. **Note:** Occasionally, a single drying procedure is not sufficient. If, after one drying procedure,  and  red light up, there is still moisture in the pump system.
Wait until  goes out.
4. Restart the drying process.

10 Cleaning and servicing

To keep your appliance working efficiently for a long time, it is important to clean and maintain it carefully.

10.1 Cleaning products

You can obtain suitable cleaning products from after-sales service or the online shop.

ATTENTION!

Unsuitable cleaning products may damage the surfaces of the appliance.

- ▶ Do not use harsh or abrasive detergents.
- ▶ Do not use cleaning products with a high alcohol content.
- ▶ Do not use hard scouring pads or cleaning sponges.
- ▶ Only use glass cleaners, glass scrapers or stainless steel care products if recommended in the cleaning instructions for the relevant part.
- ▶ Wash sponge cloths thoroughly before use.

10.2 Cleaning the appliance

WARNING – Risk of burns!

The heat-sealing bar in the vacuum-sealing compartment becomes extremely hot if the appliance is used frequently and there are long heat-sealing times.

- ▶ Never touch the hot heat-sealing bar.
- ▶ Keep children at a safe distance.

WARNING – Risk of electric shock!

An ingress of moisture can cause an electric shock.

- ▶ Do not use steam- or high-pressure cleaners to clean the appliance.

Requirements

- The appliance is switched off.
- Ensure that the heat-sealing bar in the vacuum-sealing compartment has cooled down.

1. Clean the appliance with a damp cloth and neutral cleaning agents, such as washing-up liquid and water.
During cleaning, ensure that no water or other liquid gets into the vacuum-sealing compartment or, in particular, into the vacuum pump's air outlet.
Never spray the inside or outside of the appliance with water.
2. Leave the appliance and accessory parts to fully dry after they have been cleaned.

10.3 Cleaning the glass front and glass lid

- ▶ Clean the glass front and the glass lid with glass cleaner and a soft cloth.
Do not use any abrasive sponges that may scratch or any glass scrapers.

10.4 Cleaning the stainless steel vacuum-sealing compartment

1. Always remove limescale, grease, starch or albumin stains immediately. Corrosion can form under such stains.
2. Clean with water and some washing-up liquid.
3. Dry with a soft cloth.

10.5 Cleaning the plastic control panel

- ▶ Clean the control panel using a soft cloth.
Do not use any abrasive sponges that may scratch or any glass scrapers.

10.6 Cleaning the heat-sealing bar

ATTENTION!

Cleaning in the dishwasher leads to damage.

- ▶ Never clean the appliance components in the dishwasher.
1. Remove the remaining film from the heat-sealing bar.
 2. Never use abrasive cleaning agents to clean the heat-sealing bar.
 3. Dry with a soft cloth.

10.7 Cleaning the accessories

ATTENTION!

Cleaning in the dishwasher leads to damage.

- ▶ Never clean the appliance components in the dishwasher.
1. Clean using a sponge cloth and hot soapy water in the direction of the finish.
 2. Dry with a soft cloth.

11 Troubleshooting

You can rectify minor faults on your appliance yourself. Read the troubleshooting information before contacting after-sales service. This will avoid unnecessary costs.

WARNING – Risk of injury!

Improper repairs are dangerous.

- ▶ Repairs to the appliance should only be carried out by trained specialist staff.
- ▶ If the appliance is defective, call Customer Service.

WARNING – Risk of electric shock!

Incorrect repairs are dangerous.

- ▶ Repairs to the appliance should only be carried out by trained specialist staff.
- ▶ Only use genuine spare parts when repairing the appliance.
- ▶ If the power cord of this appliance is damaged, it must be replaced by the manufacturer, the manufacturer's Customer Service or a similarly qualified person in order to prevent any risk.

11.1 Malfunctions

Fault	Cause and troubleshooting
The vacuum-sealing process will not start. start does not appear even though the lid is closed.	The door switch on the glass lid is missing or is not detected by the appliance. ▶ Call → "Customer Service", Page 14.
If you try to operate the appliance several times in succession, the vacuum-sealing process seems to run as normal but the bag is not heat-sealed.	The temperature protection switch for the heat-sealing transformer has tripped. <ol style="list-style-type: none"> 1. Allow the appliance to cool for at least 10 minutes. 2. Allow the appliance to cool for at least two minutes between vacuum-sealing operations. 3. Restart the vacuum-sealing process.
The vacuum-sealing process is taking longer and longer.	There is too much moisture in the pump system. ▶ Start the drying process. → "Starting drying", Page 9

Fault	Cause and troubleshooting
The vacuum-sealing process is taking longer and longer.	The pump system is extremely hot. <ol style="list-style-type: none"> 1. Allow the appliance to cool down. 2. Restart the vacuum-sealing process.
The bag is defective, which means that no vacuum remains in the vacuum-sealing bag.	Sharp parts of the food (such as bones) may poke holes in the bag. <ol style="list-style-type: none"> 1. Check the bag for damage. 2. Use a different bag. 3. Place sharp-edged food that is to be vacuum-sealed in a bag so that you do not damage the wall of the bag.
The heat-sealing seam is defective, which means that no vacuum remains in the vacuum-sealing bag.	The selected heat-sealing time is unsuitable for the film jacket. <ul style="list-style-type: none"> ▶ Select a different heat-sealing time. There is liquid, grease or crumbs or creases along the heat-sealed seam. <ol style="list-style-type: none"> 1. Make sure that the bag is dry, that it has no creases, and that it is positioned fully on the heat-sealing bar. 2. Use a different bag. 3. Fold over the edge of the bag by 3 cm before you fill it.
The lid cannot be opened.	A slight vacuum has formed and it is holding the lid closed. <ol style="list-style-type: none"> 1. Never use force to open the lid. 2. Initiate vacuum-sealing again and then cancel it immediately. 3. Unplug the appliance from the mains. 4. Start up the appliance again after 30 seconds. 5. Touch on/off for more than five seconds. <ul style="list-style-type: none"> ✓ The appliance is reset.

11.2 Information on display panel

Fault	Cause and troubleshooting
△ appears after a few seconds.	The glass lid has not been closed properly. <ol style="list-style-type: none"> 1. Open and close the glass lid again. 2. When doing so, lightly press on the glass lid for the first few seconds.
	The seal on the glass lid is not fitted properly or is defective. <ul style="list-style-type: none"> ▶ Check the seal.
	The seal on the glass lid has deformed. <ul style="list-style-type: none"> ▶ Gently press the seal to straighten it out.
	The lid on the external vacuum-sealing container has not been closed properly. <ol style="list-style-type: none"> 1. Check the position of the vacuum-sealing lid. 2. Only use suitable vacuum-sealing containers.
	The external vacuum-sealing connection is not positioned correctly on the vacuum-sealing compartment's air outlet. <ul style="list-style-type: none"> ▶ Check the position of the vacuum-sealing lid.
△ appears after the pump has been running for two minutes.	As the temperature rises, liquids begin to boil, meaning that the vacuum cannot be formed. <ol style="list-style-type: none"> 1. Only vacuum-seal cold liquids. 2. If the vacuum-sealing compartment is wet, wipe it dry. 3. Heat-seal the vacuum-sealing bag early if larger bubbles form. 4. Select a lower vacuum-sealing level.
🌀 and △ light up after the drying process.	One drying process alone was not sufficient. <ol style="list-style-type: none"> 1. Wait until △ no longer lights up. 2. Repeat the drying process. <p>→ "Starting drying", Page 9</p>

12 How it works

Here, you can find the ideal settings for various dishes as well as the best accessories and cookware. We have tailored these recommendations to your appliance.

12.1 Vacuum-sealing for sous-vide cooking

You can use your vacuum-sealing drawer to prepare food for sous-vide cooking. Sous-vide cooking is a method of cooking "under a vacuum" at low temperatures between 50–95 °C and in 100% steam or in a bain marie.

The vacuum-sealing drawer is used to heat-seal the food in a special air-tight, heat-resistant cooking bag.

⚠ WARNING – Risk of harm to health!

Sous-vide cooking is a method of cooking at low temperatures and, if the instructions for use and hygiene instructions are not adhered to, it may result adverse health effects.

- ▶ Only use high-quality, perfectly fresh food.
- ▶ Wash and disinfect your hands.
- ▶ Use disposable gloves, cooking tongs or grill tongs.
- ▶ Take extra care when preparing critical food, such as poultry, eggs and fish.
- ▶ Always thoroughly rinse and peel fruit and vegetables.
- ▶ Always keep work surfaces and chopping boards clean.
- ▶ Use different chopping boards for different types of food.
- ▶ Only interrupt the cold chain briefly to prepare the food.
- ▶ Store vacuum-sealed food in the refrigerator before you starting the cooking process.
- ▶ Once the food is cooked, consume it immediately. Do not store it after cooking – not even in the refrigerator. It is not suitable for reheating.

Notes

- Use the enclosed vacuum-sealing bags for sous-vide cooking. You can reorder the vacuum-sealing bags.
- Do not cook the food in the bag in which you bought it (e.g. portions of fish). These bags are not suitable for sous-vide cooking.
- Position the items of food in the bag next to each other and not on top of each other.

Vacuum-sealing for sous-vide cooking

1. In order to achieve an even heat transfer and therefore a perfect cooking result, use the highest vacuum-sealing level to vacuum-seal food.
2. Before cooking the food, check whether the vacuum in the bag is intact. To do this, refer to these points:
 - There is no air in the vacuum-sealing bag.
 - The heat-sealed seam is perfectly sealed.
 - There are no holes in the vacuum-sealing bag. Do not use a core temperature probe.
 - Pieces of meat or fish that have been vacuum-sealed together are not pressed directly against one another.
 - Vegetables and desserts are vacuum-sealed flat.
3. If the vacuum-sealing bag is not filled ideally, place the food into a new bag and vacuum-seal it again.

Note: To prevent gases escaping from the food, e. g. from vegetables, vacuum-seal the food no more than one day before the cooking process. The gases prevent the transfer of heat or cause the texture of the food to change, thus altering how it cooks, as a result of the vacuum pressure.

12.2 Fast marinating and flavouring

You can use your vacuum-sealing bag to quickly add flavour to or marinate food such as meat, fruit and vegetables.

Marinating your food in the traditional way usually takes a long time and is not particularly intensive. When you vacuum-seal in a bag, the food's cell pores open. The marinade that is added can be absorbed quickly. This produces a more intensive taste in a much shorter time.

12.3 Storing and transporting food

You can use the vacuum-sealing process to store your food for longer and can benefit from additional advantages.

- Due to the low-oxygen environment in the vacuum, freshly vacuum-sealed food remains edible for longer when it is stored correctly.
- The freezer burn is lower when the food has been frozen and vacuum-sealed.
- You can re-seal food, such as jams and sauces, in glass containers.
- The vacuum-sealing significantly increases the storage time.
- Store food such as cheese, fish or garlic without any unpleasant odours. The hermetic sealing that takes place during vacuum-sealing means that no unwanted odours can get out and the flavour cannot be absorbed by the other food.
- Sealed vacuum-sealing bags or vacuum-sealing containers are the ideal means of transport for liquid foods. They are easy to handle, leak-proof and space-saving.

ATTENTION!

Glass containers that are too tall may damage the appliance's glass lid.

- ▶ Do not use glass containers that are taller than 80 cm.

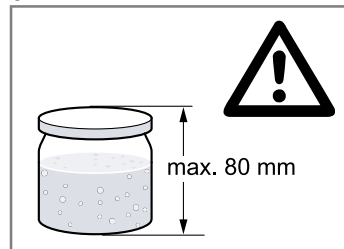

Notes

- Only use screw-top jars that are robust and intact.
- Only tighten the container by hand. The container is automatically sealed by the vacuum-sealing process.
- Not all jars or lids are suitable for being re-sealed under a vacuum. After vacuum-sealing, check whether there a vacuum has been formed. A lid that is curving inwards and can only be opened with a lot of force is an indication that the vacuuming process has worked. If the lid makes a clicking sound when it is pushed in and released and if it is easy to open, no vacuum has occurred. Repeat the vacuuming process or use more suitable screw-top jars.

12.4 Recommended settings

This section provides you with recommendations for the vacuum-sealing levels for different foods. Observe the specific information on the recommended vacuum-sealing levels and on preparing the food.

When stored appropriately, vacuum-sealed food remains fresh for significantly longer. Higher vacuum-sealing levels retain the quality, appearance and ingredients of the food.

Notes

- Only use fresh food.

- Check the quality of the food before vacuum-sealing it.
- Only vacuum-seal cold food – within a temperature range of 1–8 °C is best.
- Start at the lowest of the recommended vacuum-sealing levels.
- Check the quality of the food after you remove it from storage. Do not use any food that is of dubious quality.

Food that is stored at room temperature (20 °C to 23 °C)

Food	Vacuum-sealing level	Recommendation
Baked goods	1, 2, 3	
Dried baked items and biscuits	1	
Tea and coffee	1, 2, 3	Store in a dark place
Rice and pasta	2	Vacuum-seal in the container
Flour and semolina	1	
Nuts without shell	3	Store in a dark place
Dried fruits	3	
Crackers and crisps	1, 2	Vacuum-seal in the container

Fresh food that has been frozen (-18 °C to -16 °C) or stored in a refrigerator (3 °C to 7 °C)

Food	Vacuum-sealing level	Recommendation
Fish	3	
Poultry	3	
Meat	3	
Whole sausage	3	
Sliced sausage	3	
Hard cheese	3	
Soft cheese	2	Vacuum-seal in the container
Vegetables	2	Peel and blanch beforehand
Washed green salad	2	Vacuum-seal in the container
Herbs	1, 2	Vacuum-seal in the container
Fruit, hard	3	
Fruit, soft	2	Vacuum-seal in the container Pre-frosting recommended

13 Disposal

13.1 Disposing of old appliance

Valuable raw materials can be reused by recycling.

- Unplug the appliance from the mains.
- Cut through the power cord.
- Dispose of the appliance in an environmentally friendly manner.
Information about current disposal methods are available from your specialist dealer or local authority.



This appliance is labelled in accordance with European Directive 2012/19/EU concerning used electrical and electronic appliances (waste electrical and electronic equipment - WEEE).

The guideline determines the framework for the return and recycling of used appliances as applicable throughout the EU.

14 Customer Service

Detailed information on the warranty period and terms of warranty in your country is available from our after-sales service, your retailer or on our website.

If you contact Customer Service, you will require the product number (E-Nr.) and the production number (FD) of your appliance.

The contact details for Customer Service can be found in the enclosed Customer Service directory or on our website.

14.1 Product number (E-Nr.) and production number (FD)

You can find the product number (E-Nr.) and the production number (FD) on the appliance's rating plate.

You can see the rating plate with these numbers when you open the drawer.

Make a note of your appliance's details and the Customer Service telephone number to find them again quickly.



A series of horizontal lines for writing, starting with a solid line at the top and followed by multiple dashed lines.

EN Manufactured by BSH Hausgeräte GmbH under the trademark licence of Siemens AG

Valid within Great Britain:
Imported to Great Britain by
BSH Home Appliances Ltd.
Grand Union House
Old Wolverton Road
Wolverton, Milton Keynes
MK12 5PT
United Kingdom

BSH Hausgeräte GmbH
Carl-Wery-Straße 34
81739 München, GERMANY
siemens-home.bsh-group.com



9001790995

(040227)

en