



Register your
new device on
MyBosch now and
get free benefits:
[bosch-home.com/
welcome](https://bosch-home.com/welcome)



Microwave Oven

BE.7321.1

BE.7321.1M

[en] User manual and installation instructions

Table of contents

INFORMATION FOR USE

1	Safety	2
2	Preventing material damage	6
3	Environmental protection and saving energy	6
4	Familiarising yourself with your appliance	7
5	Accessories	8
6	Before using for the first time	9
7	Basic operation	9
8	Microwave	10
9	Microwave combi mode	11
10	Grill	12
11	Meals	13
12	Time-setting options	14
13	Childproof lock	16
14	Basic settings	16
15	Cleaning aid	17
16	Cleaning and servicing	17
17	Troubleshooting	19
18	Disposal	20
19	Customer Service	20
20	How it works	21
21	INSTALLATION INSTRUCTIONS	28
21.2	Safe installation	29

1 Safety

Observe the following safety instructions.

1.1 General information

- Read this instruction manual carefully.
- Keep the instruction manual and the product information safe for future reference or for the next owner.
- Do not connect the appliance if it has been damaged in transit.

1.2 Intended use

Only a licensed professional may connect appliances without plugs. Damage caused by incorrect connection is not covered under the warranty.

The appliance can only be used safely if it is correctly installed according to the safety instructions. The installer is responsible for ensuring that the appliance works perfectly at its installation location.

Only use this appliance:

- To prepare meals and drinks.
- Under supervision. Never leave the appliance unattended when cooking for short periods.
- For household use and similar applications, such as: In kitchens for employees in shops, offices and other commercial sectors; in agriculture; by customers in hotels and other residential facilities; in bed and breakfasts.
- up to an altitude of max. 4000 m above sea level.

This appliance complies with the standards EN 55011 and CISPR 11. It is a group 2, class B product. Group 2 means that microwaves are produced for the purpose of heating food. Class B means that the appliance is suitable for private households.

1.3 Restriction on user group

This appliance may be used by children aged 8 or over and by people who have reduced physical, sensory or mental abilities or inadequate experience and/or knowledge, provided that they are supervised or have been instructed on how to use the appliance safely and have understood the resulting dangers.

Do not let children play with the appliance. Children must not perform cleaning or user maintenance unless they are at least 15 years old and are being supervised.

Keep children under the age of 8 years away from the appliance and power cable.

1.4 Safe use

Always place accessories in the cooking compartment the right way round.

→ "Accessories", Page 8

⚠ WARNING – Risk of fire!

Combustible objects that are left in the cooking compartment may catch fire.

- ▶ Never store combustible objects in the cooking compartment.
- ▶ If smoke is emitted, the appliance must be switched off or the plug must be pulled out and the door must be held closed in order to stifle any flames.

Loose food remnants, fat and meat juices may catch fire.

- ▶ Before using the appliance, remove the worst of the food residues and remnants from the cooking compartment, heating elements and accessories.

⚠ WARNING – Risk of burns!

The appliance and its parts that can be touched become hot during use.

- ▶ Caution should be exercised here in order to avoid touching heating elements.
- ▶ Young children under 8 years of age must be kept away from the appliance.

Accessories and cookware get very hot.

- ▶ Always use oven gloves to remove accessories or cookware from the cooking compartment.

When the cooking compartment is hot, any alcoholic vapours inside may catch fire. The appliance door may spring open. Hot steam and jets of flame may escape.

- ▶ Only use small quantities of drinks with a high alcohol content in food.
- ▶ Do not heat spirits ($\geq 15\%$ vol.) when undiluted (e.g. for marinating or pouring over food).
- ▶ Open the appliance door carefully.

⚠ WARNING – Risk of scalding!

The accessible parts of the appliance become hot during operation.

- ▶ Never touch these hot parts.
- ▶ Keep children at a safe distance.

Hot steam may escape when you open the appliance door. Steam may not be visible, depending on the temperature.

- ▶ Open the appliance door carefully.
- ▶ Keep children at a safe distance.

If there is water in the cooking compartment when it is hot, this may create hot steam.

- ▶ Never pour water into the cooking compartment when the cooking compartment is hot.

⚠ WARNING – Risk of injury!

Scratched glass in the appliance door may develop into a crack.

- ▶ Do not use any harsh or abrasive cleaners or sharp metal scrapers to clean the glass on the appliance door, as they may scratch the surface.

The hinges on the appliance door move when the door is opened and closed, which could trap your fingers.

- ▶ Keep your hands away from the hinges.

⚠ WARNING – Risk of electric shock!

Improper repairs are dangerous.

- ▶ Repairs to the appliance should only be carried out by trained specialist staff.
- ▶ Only use genuine spare parts when repairing the appliance.
- ▶ If the power cord or the appliance power cable of this appliance is damaged, it must be replaced with a special power cord or special appliance power cable, which is available from the manufacturer or its Customer Service.

If the insulation of the power cord is damaged, this is dangerous.

- ▶ Never let the power cord come into contact with hot appliance parts or heat sources.
- ▶ Never let the power cord come into contact with sharp points or edges.
- ▶ Never kink, crush or modify the power cord.

An ingress of moisture can cause an electric shock.

- ▶ Do not use steam- or high-pressure cleaners to clean the appliance.

If the appliance or the power cord is damaged, this is dangerous.

- ▶ Never operate a damaged appliance.
- ▶ Never operate an appliance with a cracked or fractured surface.
- ▶ Never pull on the power cord to unplug the appliance. Always unplug the appliance at the mains.
- ▶ If the appliance or the power cord is damaged, immediately unplug the power cord or switch off the fuse in the fuse box.
- ▶ Call customer services. → *Page 20*

⚠ WARNING – Risk of suffocation!

Children may put packaging material over their heads or wrap themselves up in it and suffocate.

- ▶ Keep packaging material away from children.
- ▶ Do not let children play with packaging material.

Children may breathe in or swallow small parts, causing them to suffocate.

- ▶ Keep small parts away from children.
- ▶ Do not let children play with small parts.

1.5 Microwave

CAREFULLY READ THE IMPORTANT SAFETY INSTRUCTIONS AND KEEP THEM SAFE FOR FUTURE USE

⚠ WARNING – Risk of fire!

Using the appliance for anything other than its intended purpose is dangerous and may cause damage. For example, heated slippers and pillows filled with grain or cereal may catch fire, even several hours later.

- ▶ Never dry food or clothing with the appliance.
- ▶ Never heat up slippers, pillows filled with grain or cereal, sponges, damp cleaning cloths or similar with the appliance.
- ▶ The appliance must only be used to prepare food and drink.

Food and its packaging and containers may catch fire.

- ▶ Never heat food in heat-retaining packaging.
- ▶ Do not leave food unattended while it is heating in containers made of plastic, paper or other combustible materials.
- ▶ Never set the microwave power too high or the cooking time too long. Follow the instructions provided in this user manual.
- ▶ Never use the microwave to dry food.
- ▶ Never defrost or heat food with a low water content, such as bread, at too high a microwave power or for too long.

Cooking oil may catch fire.

- ▶ Never use the microwave to heat cooking oil on its own.

⚠ WARNING – Risk of explosion!

Liquids and other food may easily explode when in containers that have been tightly sealed.

- ▶ Never heat liquids or other food in containers that have been tightly sealed.

⚠ WARNING – Risk of burns!

Foods with peel or skin may burst or explode during heating, or even afterwards.

- ▶ Never cook eggs in their shell or heat hard-boiled eggs in their shell.
- ▶ Never cook shellfish or crustaceans.
- ▶ Always prick the yolk of eggs before microwaving.
- ▶ The skin of foods that have a peel or skin, such as apples, tomatoes, potatoes and sausages, may burst. Before heating, prick the peel or skin.

Heat is not distributed evenly through baby food.

- ▶ Never heat baby food in closed containers.
- ▶ Always remove the lid or teat.
- ▶ Stir or shake well after heating.
- ▶ Check the temperature before giving the food or drink to a child.

Heated food gives off heat. The cookware may become hot.

- ▶ Always use oven gloves to remove cookware or accessories from the cooking compartment.

Airtight packaging may burst when food is heated.

- ▶ Always follow the instructions on the packaging.
- ▶ Always use oven gloves to remove the dishes from the cooking compartment.

The accessible parts of the appliance become hot during operation.

- ▶ Never touch these hot parts.
- ▶ Keep children at a safe distance.

Using the appliance for anything other than its intended purpose is dangerous. This is because, for instance, overheated slippers, pillows filled with grain or cereal, sponges and damp cleaning cloths, etc., may cause burns to the skin.

- ▶ Never dry food or clothing with the appliance.
- ▶ Never heat up slippers, pillows filled with grain or cereal, sponges, damp cleaning cloths or similar with the appliance.
- ▶ The appliance must only be used to prepare food and drink.

⚠ WARNING – Risk of scalding!

There is a possibility of delayed boiling when a liquid is heated. This means that the liquid reaches the boiling temperature without the usual steam bubbles rising to the surface. Exercise caution even when only gently shaking the container. The hot liquid may suddenly boil over and splatter.

- ▶ Always place a spoon in the container when heating liquids. This prevents delayed boiling.

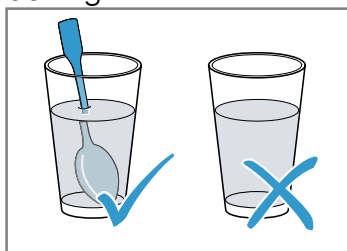

⚠ WARNING – Risk of injury!

Unsuitable cookware may crack. Porcelain or ceramic cookware can have small perforations in the handles and lid. These perforations conceal a cavity below. If moisture penetrates this cavity, it could cause the cookware to crack.

- ▶ Only use microwave-safe cookware.

Cookware and containers made from metal or cookware with metal edging may lead to sparks being formed during simple microwave operation. The appliance is damaged.

- ▶ Never use metal containers during microwave-only operation.
- ▶ Only use microwave-safe cookware or use the microwave in combination with a type of heating.

⚠ WARNING – Risk of electric shock!

The appliance uses a high voltage.

- ▶ Never remove the casing.

⚠ WARNING – Risk of serious harm to health!

Inadequate cleaning may destroy the surface of the appliance, reduce its service life, and lead to dangerous situations, such as escaping microwave energy.

- ▶ Clean the appliance on a regular basis, and remove any food residue immediately.
- ▶ Always keep the cooking compartment, door seal, door and door stop clean.
→ "Cleaning and servicing", Page 17

Never operate the appliance if the cooking compartment door or the door seal is damaged. Microwave energy may escape.

- ▶ Never use the appliance if the cooking compartment door, the door seal or the plastic door frame is damaged.
- ▶ Any repair work must only be carried out by customer service.

Microwave energy will escape from appliances that do not have any casing.

- ▶ Never remove the casing.
- ▶ For any maintenance or repair work, contact the customer service.

2 Preventing material damage

2.1 General

ATTENTION!

Alcoholic vapours may catch fire in the hot cooking compartment and cause permanent damage to the appliance. The appliance door may spring open due to an explosion and it may fall off. The door panels may shatter and fragment. Due to the resulting negative pressure, the cooking compartment may become considerably deformed inwards.

- ▶ Do not heat spirits ($\geq 15\%$ vol.) when undiluted (e.g. for marinating or pouring over food).

When the cooking compartment is hot, any water inside it will create steam. The change in temperature may cause damage.

- ▶ Never pour water into the cooking compartment when it is still hot.

The prolonged presence of moisture in the cooking compartment leads to corrosion.

- ▶ Always wipe away the condensation after cooking. Always allow the cooking compartment to cool down with the door closed after cooking at high temperatures.
- ▶ Do not keep moist food in the cooking compartment for a long time with the door closed.
- ▶ Do not store food in the cooking compartment.
- ▶ Take care not to trap anything in the appliance door.

If the seal is very dirty, the appliance door will no longer close properly during operation. This may damage the front of adjacent kitchen units.

- ▶ Keep the seal clean at all times.
- ▶ Never operate the appliance if the seal is damaged or missing.

Sitting or placing objects on the appliance door may damage it.

- ▶ Do not place, hang or support objects on the appliance door.

2.2 Microwave

Follow these instructions when using the microwave.

ATTENTION!

Metal touching the wall of the cooking compartment will cause sparks, which may damage the appliance or the inner door pane.

- ▶ Metal (e.g. a spoon in a glass) must be kept at least 2 cm from the cooking compartment walls and the inside of the door.

Placing aluminium containers in the appliance may cause sparks, which will damage the appliance.

- ▶ Do not use aluminium containers in the appliance. Operating the appliance without food in the cooking compartment may lead to overloading.
- ▶ Do not switch on the microwave unless there is food inside. The only exception to this rule is when performing a short cookware test.

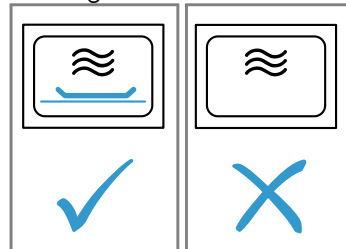

If you prepare several bags of microwave popcorn in immediate succession at a microwave power level that is too high, the cooking compartment may be damaged.

- ▶ Leave the appliance to cool down for several minutes between each use.
 - ▶ Never set a microwave power level that is too high.
 - ▶ Use a maximum microwave output of 600 watts.
 - ▶ Always place the popcorn bag on a glass plate.
- Using unsuitable cookware may result in damage.
- ▶ When using the grill or the microwave combined operation, only use cookware that can withstand high temperatures.

3 Environmental protection and saving energy

3.1 Disposing of packaging

The packaging materials are environmentally compatible and can be recycled.

- ▶ Sort the individual components by type and dispose of them separately.

3.2 Saving energy

If you follow these instructions, your appliance will use less power.

Open the appliance door as little as possible during operation.

- This will maintain the temperature in the cooking compartment and eliminate the need for the appliance to reheat.

Heat two cups of liquid at the same time.

- Heating several dishes at the same time requires less energy than heating dishes one after the other.

Switch off the display in the basic settings.

- The appliance saves energy in standby mode.

Notes

- In standby mode, the display automatically reduces the brightness to setting 1.
- The appliance requires:
 - A maximum of 0.5 W in standby mode with the display switched off

4 Familiarising yourself with your appliance

4.1 Control panel

You can use the control panel to configure all functions of your appliance and to obtain information about the operating status.

On certain models, specific details such as colour and shape may differ from those pictured.

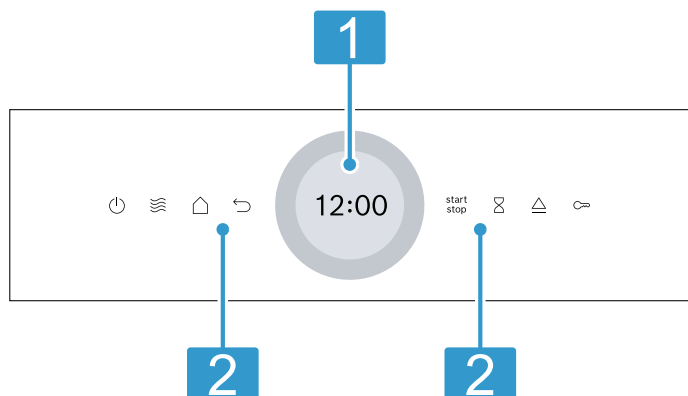

1 Display with setting ring

You can use the digital setting ring to set the appliance via the display. You will see the current setting values, options or relevant information.
→ "Touch display", Page 7

2 Touch fields

You can use the touch fields to directly set various functions.
→ "Touch fields", Page 7

4.2 Touch fields

Touch fields are touch-sensitive surfaces. To select a function, touch the relevant field.

Touch field	Function
	Switch the appliance on or off. → "Basic operation", Page 9
	Direct access to the microwave → "Microwave", Page 10
	Go back one setting.
	Start or pause operation. → "Basic operation", Page 9
	Select the timer.
	Activate or deactivate the child lock.
	Open the appliance door
	Open the "Operation modes" menu.

4.3 Touch display

The touch display shows the options you can choose from and the settings configured for the current function.

To select one of the points, touch the relevant text field.

Digital setting ring

Use the digital setting ring on the outside of the display to change the setting values.

When you reach the minimum or maximum value available, this value remains on the display. If required, use the setting ring to turn the value back again. Values can be set precisely using the setting ring by slowly moving your finger. With time settings, you can also directly select the point on the setting ring that corresponds to the required minutes or hours, e.g. press down for 30 minutes/seconds.

Settings area

The settings area is in the centre of the display. You can see current options and settings that have already been made in the settings area. The menu and other setting options are arranged horizontally. Selection lists for functions are arranged vertically. Swipe over the display to scroll in the settings area. To select a function, press the function on the display.

Possible symbols in the settings area

Symbol	Meaning
	Confirm the setting value.
	Reset the setting value.
	Change the setting value while the appliance is in operation.

4.4 Automatic door opener

If you press the automatic door-opener, the appliance door springs open. You can fully open the appliance door manually.

Notes

- In the event of a power failure, the automatic door-opening does not work. You can open the door manually.
- If you open the appliance door during operation, this pauses the operation.
- When you close the appliance door, the operation does not continue automatically. Start the operation.
- If the appliance is switched off for an extended period of time, the appliance door opens with a time delay when the door open button is pressed.

4.5 Types of heating and functions

To ensure that you always use the right type of heating to cook your food, we have explained the differences and applications below.

Name	Power/settings	Use
Microwave	90/180/360/600/"boost"	For defrosting, cooking and heating foods and liquids. → "Microwave", Page 10
Grill	Grill settings: <ul style="list-style-type: none"> ■ 1 = low ■ 2 = medium ■ 3 = high 	Grill flat items, such as sausages, or make toast. Gratin-ate food. → "Grill", Page 12
Microwave combined operation	90/180/360 W + grill settings 1/2/3	Bake bakes and gratins. The dishes are browned. → "Microwave combi mode", Page 11
Meals		There are preprogrammed settings for many dishes.
Cleaning		Select the cleaning function for the cooking compartment. → "Cleaning aid", Page 17
Basic settings		Adjust the basic settings. → "Basic settings", Page 16

4.6 Cooking compartment

The functions in the cooking compartment make your appliance easier to use.

Self-cleaning surfaces

The ceiling in the cooking compartment is self-cleaning. The self-cleaning surfaces are coated with a porous, matt ceramic layer and have a rough surface. When the appliance is in operation, the self-cleaning surfaces absorb splashes from roasting or grilling and break them down.

Interior lighting

When you open the appliance door, the interior lighting switches on. If the appliance door remains open for longer than approx. 15 minutes, the interior lighting switches off.

With most types of heating and functions, the interior lighting remains on while the appliance is in operation. The interior lighting switches off again when the operation stops.

Cooling fan

The cooling fan switches on and off as required. The hot air escapes through the ventilation slots above the appliance door.

ATTENTION!

Covering the ventilation slots will cause the appliance to overheat.



- ▶ Do not cover the ventilation slots.

To cool the cooking compartment more quickly after operation, the cooling fan continues to run for a certain period afterwards. If the appliance is running in microwave operation, the appliance remains cool, but the cooling fan still switches on. The cooling fan may continue to run even when microwave operation has ended.

4.7 Condensation

Condensation can occur in the cooking compartment and on the appliance door when cooking. Condensation is normal and does not adversely affect appliance operation. Wipe away the condensation after cooking.

4.8 Appliance door

You can open the appliance door using . If you open the appliance door during operation, the operation stops. If the appliance door is closed, you can continue operation with .

5 Accessories

Use original accessories. These have been made especially for your appliance.

The accessories supplied may differ depending on the appliance model.

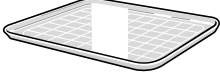
Accessories		Use
Wire rack		<ul style="list-style-type: none"> ■ The wire rack is unsuitable for maximum microwave output. ■ Wire rack for grilling and browning ■ Wire rack as a place for the cookware
Glass tray		<ul style="list-style-type: none"> ■ Splash guard when grilling directly on the wire rack ■ Place the wire rack in the glass tray ■ Suitable for use in the microwave



6 Before using for the first time

Configure the settings for initial start-up. Clean the appliance and accessories.

6.1 Initial use

You need to make settings for initial use before you can use your appliance.

Performing initial start-up

1. Press  to switch the appliance on.
 - ✓ The first setting appears.
2. To change the setting as required, press a value in the list or change the value using the setting ring. Possible settings:
 - Language
 - Time
3. Press  and switch to the next setting.
4. Work through the settings and make changes as required.
 - ✓ After the last setting, a message appears on the display confirming that configuration of the settings is complete.

6.2 Cleaning the appliance before using it for the first time

Clean the cooking compartment and accessories before using the appliance to prepare food for the first time.

1. Make sure that there is no leftover packaging, accessories or other objects in the cooking compartment.
2. Clean the smooth surfaces in the cooking compartment with a soft, damp cloth.
3. Close the appliance door.
4. Ventilate the room while the appliance is heating.
5. Set the grill to level 3.
6. Set the cooking time to 15 minutes.
7. Allow the appliance to cool down.
8. Once the cooking compartment has cooled down, clean the smooth surfaces with soapy water and a dish cloth.

6.3 Cleaning the accessories

- ▶ Clean the accessory thoroughly with soapy water and a soft dish cloth.

7 Basic operation

7.1 Switching on the appliance

- ▶ Press .
- ✓ The appliance is ready to use.



7.2 Switching off the appliance

- ▶ Press .
- ✓ The appliance stops any ongoing functions.
- ✓ The display shows the time for a few minutes.

7.3 Starting the appliance

- ▶ Press .

7.4 Pausing the operation

1. Open the appliance door or press .
- ✓ Operation is paused.
2. To continue operation, close the appliance door and press .
- ✓ Operation continues.

7.5 Cancelling the operation

- ▶ Press .
- ✓ The appliance stops any ongoing functions.

8 Microwave

You can use the microwave to cook, heat up or defrost food very quickly.

8.1 Microwave output settings

This is where you can find an overview of the different microwave output settings and recommendations on when to use them.

Microwave output in watts	Maximum cooking time in hours	Use
90 W	1:30	Defrost delicate foods.
180 W	1:30	Defrost food and continue cooking.
360 W	1:30	Cook meat and fish or heat delicate foods.
600 W	1:30	Heat and cook food.
boost	00:30	Heat liquids.

Notes

- To protect the appliance, the maximum microwave output "boost" is gradually reduced to 600 watts during the first few minutes. Maximum output is made available again after a cooling period.
- The microwave output settings do not correspond with the real power consumption of the appliance.

8.2 Microwave-safe cookware and accessories

To heat food evenly and avoid damaging your appliance, it is important to use the right cookware and accessories.

Note: Read the manufacturer's instructions before using any cookware in the microwave. If in doubt, carry out a cookware test.

→ "Testing cookware for microwave suitability", Page 10

Suitable for use in the microwave

Cookware and accessories	Reason
Cookware made from heat-resistant, microwave-safe material: <ul style="list-style-type: none"> ■ Glass ■ Glass ceramic ■ Porcelain ■ Temperature-resistant plastic ■ Fully glazed ceramic without cracks 	These materials allow microwaves to pass through. Microwaves do not damage heat-resistant cookware.
Metal cutlery	Note: You can use metal cutlery, e.g. place a spoon in a glass, to prevent delayed boiling.

ATTENTION!

Metal touching the wall of the cooking compartment will cause sparks, which may damage the appliance or the inner door pane.

- ▶ Metal (e.g. a spoon in a glass) must be kept at least 2 cm from the cooking compartment walls and the inside of the door.

Not microwave-safe

Cookware and accessories	Reason
Metal cookware	Metal does not allow microwaves to pass through. The food hardly heats up.
Cookware with gold or silver decoration	Microwaves can damage gold and silver decoration. Tip: You can only use this kind of cookware if the manufacturer guarantees that it is microwave-safe.

8.3 Testing cookware for microwave suitability

Test cookware to see whether it is suitable for microwave use. Testing cookware is the only time the appliance should be operated in microwave mode without any food inside.



WARNING – Risk of scalding!

The accessible parts of the appliance become hot during operation.

- ▶ Never touch these hot parts.
 - ▶ Keep children at a safe distance.
1. Place the empty cookware in the cooking compartment.
 2. Set the appliance to the maximum microwave power setting for 30 seconds to 1 minute.
 3. Start the operation.
 4. Check the cookware several times:
 - If the cookware is cold or warm to the touch, it is suitable for microwave use.

- If the cookware becomes hot or sparks are created, stop the cookware test. The cookware is not microwave-safe.

8.4 QuickStart

1. Press .
2. Use  to start the operation.
 - ✓ The preset microwave output is started for 1 minute.





Note: You can change the presetting for the microwave output in the basic settings. → *Page 16*

8.5 Setting the microwave

Note:

Note the correct way to operate the microwave:

- Follow the safety instructions. → *Page 4*
- Observe the instructions on how to prevent material damage. → *Page 6*
- Observe the information on microwave-safe cookware and accessories.

1. Press "Microwave" in the menu.
 - Or select the microwave directly using the touch field .
2. Press the microwave output in watts.
3. Use the setting ring to set the microwave output.
4. To confirm the microwave output, press ✓ on the display
5. Press  "Cooking time".
A cooking time must always be set to operate the microwave.
6. To change the preset cooking time, press the relevant time value, e.g. minute display "m" or second display "s".
 - ✓ The selected value is marked in blue.
7. Use the setting ring to set the cooking time.
If required, use  to reset the setting value.
8. To confirm the set cooking time, press ✓ on the display.
9. Press  to start the operation.
 - ✓ The microwave starts and the cooking time counts down. The display shows the performance reduction for the maximum microwave output "boost".
 - ✓ When the time has elapsed, a signal tone sounds. A notification appears on the display confirming that the operation has finished.
10. Once the cooking time has elapsed:
 - If required, you can select other settings and re-start the operation.

- When the food is ready, use  to switch the appliance off.

11. Dry the cooking compartment.

Tip: To ensure optimum use of your appliance, refer to the information in the recommended settings.



→ *"How it works", Page 21*

8.6 Changing the microwave output

You can change the microwave output setting during operation.



1. Press .
2. Press the set microwave output setting.
3. Use the setting ring to set the microwave output.
4. Press ✓.

8.7 Changing the cooking time



1. Press .
2. Press the set "Cooking time".
3. To change the preset cooking time, press the relevant time value, e.g. minute display "m" or second display "s".
 - ✓ The selected value is marked in blue.
4. Use the setting ring to set the cooking time.
If required, use  to reset the setting value.
5. Press ✓.

8.8 Extending the cooking time

Once the cooking time has elapsed, you can continue cooking the food.

1. Press "Add extra cooking time".
2. Set the required cooking time.
→ *"Setting the cooking time", Page 15*
You can reset the set cooking time using .
3. Press ✓.
4. Use  to start the operation.

8.9 Pausing the operation

1. Open the appliance door or press .
✓ Operation is paused.
2. To continue operation, close the appliance door and press .
✓ Operation continues.

8.10 Cancelling the operation

- ▶ Press .
- ✓ The appliance stops any ongoing functions.

9 Microwave combi mode

To reduce the cooking time or if you want to heat and brown foods at the same time, you can use the grill in combination with the microwave.

The following microwave output settings are available to choose from:

- 90 W
- 180 W
- 360 W

9.1 Setting added microwave

Requirement: The appliance is switched on.

1. Press "Grill".
2. Press "Level".
 - Use the setting ring to select the required grill setting.
 - Press ✓.
3. Press "Microwave function".

- Use the setting ring to select the required microwave output.
- Press ✓.
- ✓ A preset cooking time appears on the display.
- 4. If you want to change the preset cooking time, press "Cooking time".
 - Use the setting ring to select the required cooking time.
 - Press ✓.
- 5. If an end time is required, press "End".
 - Use the setting ring to select the required time.
 - Press ✓.
- 6. Use $\overset{\text{start}}{\text{stop}}$ to start the operation.
- ✓ An audible signal sounds once the cooking time has elapsed.

9.2 Changing the grill setting

You can change the grill setting during operation.

1. Press ^.
2. Press the set grill setting.
3. Use the setting ring to select the required grill setting.
4. Press ✓.

9.3 Changing the microwave output

You can change the microwave output setting during operation.

1. Press ^.
2. Press the set microwave output setting.
3. Use the setting ring to set the microwave output.
4. Press ✓.

9.4 Changing the cooking time

1. Press ^.
2. Press the set "Cooking time".
3. To change the preset cooking time, press the relevant time value, e.g. minute display "m" or second display "s".
 - ✓ The selected value is marked in blue.
4. Use the setting ring to set the cooking time. If required, use \odot to reset the setting value.
5. Press ✓.

9.5 Extending the cooking time

Once the cooking time has elapsed, you can continue cooking the food.

1. Press "Add extra cooking time".
2. Set the required cooking time.
 - "Setting the cooking time", Page 15
 - You can reset the set cooking time using \odot .
3. Press ✓.
4. Use $\overset{\text{start}}{\text{stop}}$ to start the operation.

9.6 Pausing the operation

1. Open the appliance door or press $\overset{\text{start}}{\text{stop}}$.
 - ✓ Operation is paused.
2. To continue operation, close the appliance door and press $\overset{\text{start}}{\text{stop}}$.
- ✓ Operation continues.

9.7 Cancelling the operation

- ▶ Press \odot .
- ✓ The appliance stops any ongoing functions.

10 Grill

You can brown or gratinate your food using the grill. You can use the grill on its own or in combination with the microwave.

10.1 Grill settings

The following grill settings are available.

Grill setting	Food
1 (low)	<ul style="list-style-type: none"> ■ Deep-dish bakes ■ Soufflés
2 (medium)	<ul style="list-style-type: none"> ■ Shallow bakes ■ Fish
3 (high)	<ul style="list-style-type: none"> ■ Sausages ■ Toast

10.2 Safety switch-off function

For your safety, the appliance has a safety shut-off function. The appliance is automatically switched off if it has been in operation for an extended period.

How long the appliance waits before switching itself off depends on the setting:

- Grill: 90 minutes

10.3 Setting the grill

Requirement: The appliance is switched on.

1. Press "Grill".
2. Press "Level".
3. Select the required grill setting.
4. Press ✓.
5. If a cooking time is required, set the cooking time.
 - Press "Cooking time".
 - Use the setting ring to select the required cooking time.
 - Press ✓.
6. If an end time is required, set the end time.
 - Press "End".
 - Use the setting ring to select the required end time.
 - Press ✓.
7. Use $\overset{\text{start}}{\text{stop}}$ to start the operation.
- ✓ An audible signal sounds once the cooking time has elapsed.

10.4 Changing the grill setting

You can change the grill setting during operation.

1. Press ^.
2. Press the set grill setting.

3. Use the setting ring to select the required grill setting.
4. Press ✓.

10.5 Changing the cooking time

1. Press ^.
2. Press the set "Cooking time".
3. To change the preset cooking time, press the relevant time value, e.g. minute display "m" or second display "s".
 - ✓ The selected value is marked in blue.
4. Use the setting ring to set the cooking time. If required, use ⌚ to reset the setting value.
5. Press ✓.

10.6 Extending the cooking time

Once the cooking time has elapsed, you can continue cooking the food.

1. Press "Add extra cooking time".
2. Set the required cooking time.
→ "Setting the cooking time", Page 15
You can reset the set cooking time using ⌚.
3. Press ✓.
4. Use $\overset{\text{start}}{\text{stop}}$ to start the operation.

10.7 Pausing the operation

1. Open the appliance door or press $\overset{\text{start}}{\text{stop}}$.
 - ✓ Operation is paused.
2. To continue operation, close the appliance door and press $\overset{\text{start}}{\text{stop}}$.
 - ✓ Operation continues.

10.8 Cancelling the operation

- ▶ Press ⏻.
- ✓ The appliance stops any ongoing functions.

11 Meals

The "Meals" operating mode helps you to use your appliance to prepare different meals by selecting the optimum settings automatically.

11.1 Tips on configuring the settings for dishes

Follow these tips to achieve optimal cooking results:

- Only use food that is in perfect condition.
- Take the food out of its packaging and weigh it. If you cannot set the exact weight on the appliance, round the weight up or down.
- Only use microwave-safe, heat-resistant cookware, e.g. made of glass or ceramic.
- Place the food in the cold cooking compartment.

Defrosting

- Freeze and store food flat and in portion-sized quantities at -18 °C.
- Place the frozen food on flat cookware, such as a glass or porcelain plate.
- Food may not be completely defrosted by the end of the programme. The food can nonetheless be further processed.
- To allow the temperature to equalise, leave the defrosted food to rest for another 10 to 30 minutes in the appliance after switching it off.
- Liquid is produced when defrosting meat or poultry. When turning, drain off any liquid. Do not reuse the liquid for other purposes or allow it to come into contact with other foods.
- After turning, remove any minced meat that has already defrosted.
- Whole poultry should be placed on the cookware breast-side down and poultry portions skin-side down.

Vegetables

- Fresh vegetables: Cut into pieces of equal size. Add one tablespoon of water per 100 g.

- Frozen vegetables: Only suitable for blanched, not pre-cooked vegetables. It is not suitable for frozen vegetables in cream sauce. Add 1 to 3 tablespoons of water. Do not add any water for spinach or red cabbage.

Potatoes

- Boiled potatoes: Cut into pieces of an equal size. Add two tablespoons of water and some salt per 100 g.
- Unpeeled boiled potatoes: Use potatoes of the same thickness. Wash them and prick the skin. Place the wet potatoes in a dish. Do not add water.
- Baked potatoes: Use potatoes of the same thickness. Wash, dry and prick the skin.

Rice

- Do not use brown rice or boil-in-the-bag rice.
- Add two to two-and-a-half times the amount of water to the rice.

Poultry

- Only use chicken portions at refrigerator temperature.
- Prick the skin here and there with a fork.
- Place the chicken portions on the wire rack, skin side up. Place the wire rack in the glass tray. This will catch any liquid that drips down.

Lasagne

- Best suited is frozen Lasagne with a maximum height of around 3 cm.
- Take lasagne out of the packaging and place in microwave-safe cookware.
- If you prepare frozen lasagne in portions of more than 700 g, place the cookware on a microwave-safe, upside down plate.

11.2 Setting a programme

Requirement: The appliance is switched on.



1. Press "Meals".
2. Select a programme.

3. Press the preset weight.
4. Use the control ring to set the required weight.
5. Use ✓ to confirm the weight.
6. If an end time is required, set the end time.
 - Press "End".
 - Set the required time.
 - Use ✓ to confirm the end time.
7. Place the food in the cooking compartment.
8. Close the appliance door.
9. Press .
 - ✓ An audible signal sounds once the cooking time has elapsed.



Note: For some programmes, the display provides instructions during preparation. Follow the information provided.

Extending the cooking time

Once the cooking time has elapsed, you can continue cooking the food.

1. Press "Add extra cooking time".
2. Set the required cooking time.
→ "Setting the cooking time", Page 15
You can reset the set cooking time using .
3. Press ✓.
4. Use  to start the operation.

Pausing the operation

1. Open the appliance door or press .
 - ✓ Operation is paused.
2. To continue operation, close the appliance door and press .
 - ✓ Operation continues.

Cancelling the operation

- ▶ Press .
- ✓ The appliance stops any ongoing functions.

11.3 Overview of dishes

Dish	Suitable food	Weight range in kg	Cookware/accessories
Defrost bread ¹	Bread, whole, round or long; sliced bread; sponge cake, yeast cake, fruit flan, cakes without icing, cream or gelatine	0.20-1	Shallow cookware without lid
Defrost meat ¹	Joints, flat pieces of meat, chicken, minced meat	0.20-2	Shallow cookware without lid
Defrost fish ¹	Whole fish, fish fillet, fish steak	0.10-1	Shallow cookware without lid
Fresh vegetables ²	e.g. cauliflower, broccoli, carrots, kohlrabi, leeks, peppers, courgettes	0.15-1	Covered cookware
Frozen vegetables ²	e.g. cauliflower, broccoli, carrots, kohlrabi, red cabbage, spinach	0.15-1	Covered cookware
Rice ²	Long-grain rice	0.05-0.3	Deep cookware with lid
Boiled potatoes ²	Potatoes with or without skin, potatoes cut into pieces of equal size	0.20-1	Covered cookware
Baked potatoes ¹	Potatoes with skin, 200-250 g each	0.20-1.5	Wire rack on glass tray
Lasagne, frozen	Lasagne or a similar frozen bake	0.30-1	Uncovered cookware
Chicken pieces, fresh	Chicken thigh, chicken drumstick, chicken leg	0.50-1	Wire rack on glass tray



¹ Observe the signals given when it is time to turn the food.

² Observe the signals given when it is time to stir the food.

12 Time-setting options

Your appliance offers time-setting options that you can use to set the cooking time, the end time and the timer.



Time-setting options	Use
Cooking time 	If you set a cooking time, the appliance stops heating automatically once this time has elapsed.

Time-setting options	Use
End 	For the cooking time, you can set the time at which you want the operation to end. The appliance starts up automatically so that the operation finishes at the required time.
Timer 	You can set the timer to run independently of the operation. It does not affect the appliance.

12.1 Setting the cooking time



You can use "boost" to set the cooking time for the operation up to 30 minutes. You can set a cooking time for all other settings of up to 90 minutes.

Requirement: An operating mode and level have been set.

1. Press "Cooking time".
2. To change the preset cooking time, press the relevant time value, e.g. minute display "m" or second display "s".
 - ✓ The selected value is marked in blue.
3. Use the setting ring to set the cooking time. If required, use  to reset the setting value.
4. Press .
5. Use  to start the operation.



Extending the cooking time

Once the cooking time has elapsed, you can continue cooking the food.

1. Press "Add extra cooking time".
2. Set the required cooking time.
→ "Setting the cooking time", Page 15
You can reset the set cooking time using .
3. Press .
4. Use  to start the operation.



Changing the cooking time

You can change the cooking time at any time.

1. Press "Cooking time".
2. To change the preset cooking time, press the relevant time value, e.g. minute display "m" or second display "s".
 - ✓ The selected value is marked in blue.
3. Use the setting ring to set the cooking time. If required, use  to reset the setting value.
4. Press .

Cancelling the cooking time

You can cancel the cooking time at any time.

1. Press the cooking time.
2. Reset the cooking time using .
For operating modes that always require a cooking time, the appliance resets the cooking time to the preset value.
3. Press .

12.2 Setting the end time



You can delay the time at which the cooking time for the operation is due to end by up to 24 hours.

Notes

- To achieve good cooking results, do not delay the time once the operation has already started.
- Food will spoil if you leave it in the cooking compartment for too long.



Requirements

- An operating mode and level have been set.
 - A cooking time has been set.
1. Press "End".
 2. To change the preset end time, press the relevant time value.
 - ✓ The selected value is marked in blue.
 3. Use the setting ring to set the end time.
 4. Press .



5. Press .
 - ✓ The display shows the start time. The appliance is in standby mode.
 - ✓ Once the start time has been reached, the appliance starts heating and the cooking time starts counting down.
 - ✓ When the cooking time has elapsed, a signal sounds. A message appears on the display confirming that the operation has finished.
6. Once the cooking time has elapsed, perform one of the following actions:
 - If required, you can select other settings and re-start the operation.
 - When the food is ready, use  to switch the appliance off.

Changing the end time

To achieve good cooking results, only change the set time before the operation starts and before the cooking time starts counting down.



1. Press "End".
2. Use the setting ring to set the end time. If required, use  to reset the setting value.
3. Press .

Cancelling the end time

1. Press "End".
2. Reset the setting value with .
3. Press .

12.3 Setting the timer

The timer runs independently during the operation. You can set the timer for a time up to 24 hours. The timer has its own signal so that you can tell whether it is the timer or a cooking time that has elapsed.

1. Press .
2. To set the timer, press the relevant time value on the display, e.g. minute display "m" or second display "s".
 - ✓ The selected value is marked in blue.
3. Set the timer using the setting ring.
 - ✓ If required, use  to reset the setting value.
4. To start the timer, press .
 - ✓ The timer counts down.
 - ✓ The timer remains visible on the display if the appliance is switched off.
 - ✓ When the appliance is switched on, the display shows the settings for the current operation. The timer is displayed in the status display.
 - ✓ Once the timer has elapsed, a signal sounds. A notification appears on the display confirming that the timer has finished.



Ending the timer

Requirement: A signal sounds.

- ▶ Press any field.
- ✓ The timer is switched off.

Changing the timer

You can change the timer at any time.

1. If the timer is running in the background, use  to select the timer beforehand.
2. Press .
3. Change the timer using the setting ring.

4. Press \triangleright to confirm.

Cancelling the timer

You can cancel the timer at any time.

1. If the timer is running in the background, use \otimes to select the timer beforehand.
2. Press || .
3. Reset the timer using $\text{\textcircled{C}}$.

13 Childproof lock

You can secure your appliance to prevent children from accidentally switching it on or changing the settings.

13.1 Activating the childproof lock

- ▶ Press and hold ∞ for approx. 4 seconds.
- ✓ The control elements are locked.

- ✓ If a timer duration has been set, this continues to count down. While the child lock is active, the timer duration cannot be changed. To end signal tones, e.g. once the timer duration has elapsed, press any button.

13.2 Deactivating the childproof lock

1. Turn the ring 360°.
2. Alternatively, press and hold the ∞ button for approx. 4 seconds.
3. The control elements are unlocked.

14 Basic settings

You can configure the basic settings for your appliance to meet your needs.

14.1 Overview of the basic settings

Here you can find an overview of the basic settings and factory settings. The basic settings depend on the features of your appliance.

Notes

- Changes to the language, button tone and display brightness settings take effect immediately. All other settings do not take effect until you save them.
- Your changes to the basic settings will be retained for some time even after a power cut.

Basic settings	Selection
Language	See selection on the appliance
Time	"Time" in 24-hour format

Display	Selection
Brightness	<ul style="list-style-type: none"> ■ Settings 1 to 8¹
Standby screen	<ul style="list-style-type: none"> ■ On (this setting increases energy consumption) ■ Clock displayed, for set time¹ ■ Off
Clock	<ul style="list-style-type: none"> ■ Digital¹ ■ Analog
Adjustment	<ul style="list-style-type: none"> ■ Align the display horizontally and vertically.

¹ Factory setting (may vary according to model)

Sound	Selection
Button tone	<ul style="list-style-type: none"> ■ On¹ ■ Off
Signal tone	<ul style="list-style-type: none"> ■ Very short ■ Short duration ■ Medium duration¹ ■ Long duration

¹ Factory setting (may vary according to model)

Appliance settings	Selection
Illumination	<ul style="list-style-type: none"> ■ On¹ ■ Off
Microwave output selection	<ul style="list-style-type: none"> ■ 90 W ■ 180 W ■ 360W ■ 600 W ■ boost

¹ Factory setting (may vary according to model)

Customisation	Selection
Brand logo	<ul style="list-style-type: none"> ■ Display¹ ■ Don't display
Operat. after switch-on	<ul style="list-style-type: none"> ■ Main menu¹ ■ Microwave ■ Meals ■ Grill
Elapsed cooking time	<ul style="list-style-type: none"> ■ Display¹ ■ Don't display
Childproof lock	<ul style="list-style-type: none"> ■ Available ■ Deactivated

¹ Factory setting (may vary according to model)

Factory settings	Selection
Factory settings	<ul style="list-style-type: none"> ▪ Restore ▪ Cancel
Appliance information	<ul style="list-style-type: none"> ▪ Displaying "Appliance information"

14.2 Changing the basic settings

Requirement: The appliance is switched on.

1. Press "Basic settings".
2. Press the required basic setting.
3. Change the required settings on the display.
4. Use  to return to the overview or go back to the main menu.

14.3 Changing the time

Requirement: The appliance is switched on.

1. Press "Basic settings".
2. Press the "Time" basic setting.
 - ✓ The display shows the set value.
3. Use the setting ring to set the hours.
4. Press the minutes.
5. Use the setting ring to set the minutes.
6. Press ✓.
7. Use  to return to the overview or go back to the main menu.

15 Cleaning aid

The cleaning aid is a quick alternative for occasionally cleaning the cooking compartment. The cleaning aid softens dirt by evaporating the soapy water. It is then easier to remove the dirt.

ATTENTION!

Incorrect cleaning may damage the appliance.

- ▶ Never pour liquid into the cooking compartment.

15.1 Setting the cleaning aid

Requirement: The appliance is switched on.

1. Press "Cleaning".
2. Follow the instructions on the display.
3. Press .
 - ✓ A signal tone sounds once the time has elapsed.
4. Follow the instructions on the display.

16 Cleaning and servicing

To keep your appliance working efficiently for a long time, it is important to clean and maintain it carefully.

16.1 Cleaning products

Only use suitable cleaning agents.

WARNING – Risk of electric shock!

An ingress of moisture can cause an electric shock.

- ▶ Do not use steam- or high-pressure cleaners to clean the appliance.

ATTENTION!

Unsuitable cleaning agents damage the surfaces of the appliance.

- ▶ Do not use harsh or abrasive cleaning products.
- ▶ Do not use cleaning products with a high alcohol content.
- ▶ Do not use hard scouring pads or cleaning sponges.
- ▶ Do not use any special cleaners for cleaning the appliance while it is hot.
- ▶ Only use glass cleaners, glass scrapers or stainless steel care products if recommended in the cleaning instructions for the relevant part.

Salt contained in new sponge cloths may damage surfaces.

- ▶ Wash new sponge cloths thoroughly before use.

You can find out which cleaning products are suitable for each surface or part of the appliance in the individual cleaning instructions.

16.2 Cleaning the appliance

Clean the appliance as specified. This will ensure that the different parts and surfaces of the appliance are not damaged by incorrect cleaning or unsuitable cleaning products.

WARNING – Risk of burns!

The appliance and its parts that can be touched become hot during use.

- ▶ Caution should be exercised here in order to avoid touching heating elements.
- ▶ Young children under 8 years of age must be kept away from the appliance.

WARNING – Risk of fire!

Loose food remnants, fat and meat juices may catch fire.

- ▶ Before using the appliance, remove the worst of the food residues and remnants from the cooking compartment, heating elements and accessories.

WARNING – Risk of injury!

Scratched glass in the appliance door may develop into a crack.

- ▶ Do not use any harsh or abrasive cleaners or sharp metal scrapers to clean the glass on the appliance door, as they may scratch the surface.

1. Read the information on cleaning products.
2. Observe the information on cleaning the appliance components or surfaces.
3. Unless otherwise specified:
 - Clean the components of the appliance with hot soapy water and a dish cloth.
 - Dry with a soft cloth.

16.3 Cleaning the cooking compartment

ATTENTION!

Incorrect cleaning may damage the cooking compartment.

- ▶ Do not use oven spray, abrasive materials or other aggressive oven cleaners.
- 1. Read the information on cleaning products.
- 2. Clean with hot soapy water or a vinegar solution.
- 3. To remove very heavy soiling use oven cleaner suitable for stainless steel surfaces.
Only use oven cleaner when the cooking compartment is cold.
Tip: To eliminate unpleasant odours, heat up a cup of water with a few drops of lemon juice for 1 to 2 minutes at maximum microwave power setting. Always place a spoon in the container to prevent delayed boiling.
- 4. Wipe out the cooking compartment with a soft cloth.
- 5. Leave the cooking compartment to dry with the door open.

16.4 Regenerating self-cleaning surfaces in the cooking compartment

The ceiling in the cooking compartment is self-cleaning. The self-cleaning surfaces are coated with a porous, matt ceramic layer and have a rough surface. When the grill function is in operation, the self-cleaning surfaces absorb splashes from roasting or grilling and break down the grease residues. If you are primarily using the microwave function, start the grill function at regular intervals to clean the ceiling.

ATTENTION!

Using oven cleaner on the self-cleaning surfaces damages the surfaces.

- ▶ Do not use oven cleaner on the self-cleaning surfaces. If oven cleaner does get onto these surfaces, dab it off immediately using water and a sponge cloth. Do not rub the surface and do not use abrasive cleaning aids.

Requirements

- The cooking compartment is empty.
- The appliance is switched on.
- 1. Press "Grill".
- 2. Press "Level".
- 3. Select the highest grill setting.
- 4. Press ✓.
- 5. Press "Cooking time".
- 6. Set the required cooking time.
The cleaning time depends on the amount of grease residues. Start with a duration of 20 minutes.
- 7. Press ✓.
- 8. Press $\overset{\text{start}}{\text{stop}}$ to start the operation.
Ventilate the room while the appliance is heating.
- ✓ Smoke can build up during operation. This is normal and reduces.
- ✓ An audible signal sounds once the cooking time has elapsed.
- 9. If smoke is still visible at the end of the duration, increase the duration.

16.5 Cleaning the accessories

1. Read the information on cleaning products.

2. Soften baked-on food remnants with a damp dish cloth and hot soapy water.
3. Clean the accessory with hot soapy water and a soft dish cloth or a scrubbing brush.
4. Clean the wire rack with stainless steel cleaner or in the dishwasher.
Use steel wool or oven cleaner to remove very heavy soiling.
5. Dry with a soft cloth.

16.6 Cleaning the door panels

ATTENTION!

Incorrect cleaning may damage the door panes.

- ▶ Do not use a glass scraper.
- 1. Read the information on cleaning products.
- 2. Clean the door panels with a soft dish cloth and glass cleaner.
Note: Shadows on the door panels, which look like streaks, are caused by reflections made by the interior lighting.
- 3. Dry with a soft cloth.

16.7 Cleaning the door seal

ATTENTION!

Incorrect cleaning may damage the door seal.

- ▶ Do not use metal scrapers or glass scrapers for cleaning.
- ▶ Do not use abrasive cleaning agents.
- 1. Read the information on cleaning products.
- 2. Clean the door seal with hot soapy water and a soft dish cloth.
- 3. Dry with a soft cloth.

16.8 Cleaning the front of the appliance

ATTENTION!

Incorrect cleaning may damage the front of the appliance.

- ▶ Do not use glass cleaner, metal scrapers or glass scrapers for cleaning.
- ▶ To prevent corrosion on stainless steel fronts, remove any limescale, grease, starch and albumin (e.g. egg white) stains immediately.
- ▶ On stainless steel surfaces, use special stainless steel cleaning products suitable for hot surfaces.
- 1. Read the information on cleaning products.
- 2. Clean the front of the appliance using hot soapy water and a dish cloth.
Note: Slight differences in colour on the front of the appliance are caused by the use of different materials, such as glass, plastic and metal.
- 3. For stainless steel appliance fronts, apply a thin layer of the stainless steel cleaning product with a soft cloth.
You can obtain the stainless steel cleaning products from the after-sales service or the online shop.
- 4. Dry with a soft cloth.

16.9 Cleaning the control panel

ATTENTION!

Incorrect cleaning may damage the control panel.

- ▶ Never wipe the control panel with a wet cloth.

1. Read the information on cleaning products.
2. Clean the control panel using a microfibre cloth or a soft, damp cloth.

3. Dry with a soft cloth.

17 Troubleshooting

You can rectify minor faults on your appliance yourself. Read the troubleshooting information before contacting after-sales service. This will avoid unnecessary costs.

WARNING – Risk of injury!

Improper repairs are dangerous.

- ▶ Repairs to the appliance should only be carried out by trained specialist staff.
- ▶ If the appliance is defective, call Customer Service.
→ "Customer Service", Page 20

WARNING – Risk of electric shock!

Improper repairs are dangerous.

- ▶ Repairs to the appliance should only be carried out by trained specialist staff.
- ▶ Only use genuine spare parts when repairing the appliance.
- ▶ If the power cord or the appliance power cable of this appliance is damaged, it must be replaced with a special power cord or special appliance power cable, which is available from the manufacturer or its Customer Service.

17.1 Malfunctions

Fault	Cause and troubleshooting
The appliance is not working.	The mains plug of the power cord is not plugged in. ▶ Connect the appliance to the power supply.
	The circuit breaker in the fuse box has tripped. ▶ Check the circuit breaker in the fuse box.
	There has been a power cut. ▶ Check whether the lighting in your room or other appliances are working.
	Malfunction 1. Switch off the fuse in the fuse box. 2. Switch the fuse back on after approx. 10 seconds. ✓ If the fault was a one-off, the message disappears. 3. If the message appears again, call the after-sales service. Please specify the exact error message when calling. → "Customer Service", Page 20
Microwave not working.	Door is not fully closed. ▶ Check whether food remains or foreign material are trapped in the door.
Food does not heat up.	Demo mode is activated in the basic settings. 1. Disconnect the appliance from power supply by briefly switching off the circuit breaker in the fuse box. 2. Go to the basic settings and deactivate Demo mode within the next 5 minutes. → Page 16
The interior lighting is not working.	Different causes are possible. ▶ Call → "Customer Service", Page 20.
Microwave mode is cancelled.	Malfunction 1. reset the appliance <ul style="list-style-type: none"> - Press and hold  button for at least 10 seconds. - Or switch off the fuse in the fuse box. Switch the fuse back on after approx. 10 seconds. ✓ If the fault was a one-off, the message disappears. 2. If the message appears again, call the after-sales service. Please specify the exact error message when calling. → "Customer Service", Page 20
Food takes longer than usual to heat up.	The microwave power setting is set too low. ▶ Set a higher microwave power setting.

Fault	Cause and troubleshooting
Food takes longer than usual to heat up.	A larger amount than usual has been placed in the appliance. <ul style="list-style-type: none"> ▶ Set a longer cooking time. You need double the time when you have double the amount.
	The food is colder than usual. <ul style="list-style-type: none"> ▶ Turn or stir the food from time to time during cooking.
Time not displayed when appliance switched off	Display switches itself off after a short time. No action required.

17.2 Information on display panel

Fault	Cause and troubleshooting
Message showing "D" or "E" appears in the display.	Malfunction <ol style="list-style-type: none"> 1. Reset appliance. <ul style="list-style-type: none"> - Either press and hold  for at least 6 seconds. - Or switch off the circuit breaker or fuse in the electrical panel. Switch the fuse back on after approx. 10 seconds. ✓ If the fault was a one-off, the message will disappear. 2. If the message appears again, call the after-sales service. Please specify the exact error message when calling. → "Customer Service", Page 20

18 Disposal

18.1 Disposing of old appliance

Valuable raw materials can be reused by recycling.

1. Unplug the appliance from the mains.
2. Cut through the power cord.
3. Dispose of the appliance in an environmentally friendly manner.
Information about current disposal methods are available from your specialist dealer or local authority.



This appliance is labelled in accordance with European Directive 2012/19/EU concerning used electrical and electronic appliances (waste electrical and electronic equipment - WEEE).
The guideline determines the framework for the return and recycling of used appliances as applicable throughout the EU.

19 Customer Service

Detailed information on the warranty period and terms of warranty in your country is available from our after-sales service, your retailer or on our website.

If you contact Customer Service, you will require the product number (E-Nr.) and the production number (FD) of your appliance.

The contact details for Customer Service can be found in the enclosed Customer Service directory or on our website.

This product contains light sources from energy efficiency class D. These light sources are available as a spare part and should only be replaced by trained specialist staff.

19.1 Product number (E-Nr.) and production number (FD)

You can find the product number (E-Nr.) and the production number (FD) on the appliance's rating plate. You will see the rating plate with these numbers if you open the appliance door.

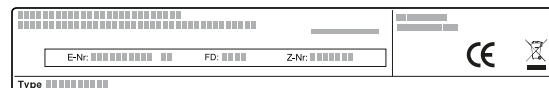

Make a note of your appliance's details and the Customer Service telephone number to find them again quickly.

20 How it works

Here, you can find the ideal settings for various dishes as well as the best accessories and cookware. We have tailored these recommendations to your appliance.

20.1 What is the best way to proceed?

In this section, you will find out the best way to proceed using step-by-step instructions to make optimal use of the recommended settings. You will get information on many meals, with details and tips on how to best use and set your appliance.

Tip

Cooking tips

- The recommended settings always apply to the cooking compartment when it is cold and empty.
- The times specified in the overviews are intended as a guide only. They will depend on the quality and composition of the food.

WARNING – Risk of burns!

Foods with peel or skin may burst or explode during heating, or even afterwards.

- ▶ Never cook eggs in their shell or heat hard-boiled eggs in their shell.
- ▶ Never cook shellfish or crustaceans.
- ▶ Always prick the yolk of eggs before microwaving.
- ▶ The skin of foods that have a peel or skin, such as apples, tomatoes, potatoes and sausages, may burst. Before heating, prick the peel or skin.

ATTENTION!

Acidic food may damage the grid

- ▶ Do not place acidic food, such as fruit or food with an acidic marinade directly on the pan support.

Defrosting with the microwave

Note:

Cooking tips

- Freeze the food flat.
- Use microwave-safe cookware without a lid.
- Place the cookware on the bottom of the cooking compartment.
- Turn or stir the food 2 to 3 times during this time. When turning, remove any liquid that escapes during defrosting.
- Liquid is produced when defrosting meat or poultry. When turning, drain off any liquid. Do not use this for other purposes or allow it to come into contact with other foods.
- After turning, remove any minced meat that has already defrosted.
- Separate any defrosted parts when turning.
- To allow the temperature to equalise, leave the defrosted food to rest for another 10 to 30 minutes in the appliance after switching it off.

Food	Weight	Microwave output	Cooking time
Whole pieces of meat, on the bone or boned ¹	800 g	1. 180 W 2. 90 W	1. 10 min 2. 15-20 mins
Whole pieces of meat, on the bone or boned ¹	1000 g	1. 180 W 2. 90 W	1. 15 min 2. 20 min

¹ Turn the food several times.

² Separate any defrosted parts when turning.

³ Carefully stir the food occasionally.

⁴ Remove all packaging.

⁵ Only defrost cakes without icing, whipped cream, gelatine or custard.

⁶ Separate the pieces of cake.

Note: Information for those allergic to nickel

In rare cases, small amounts of nickel may pass into the food.

1. Before using the appliance, remove all unnecessary cookware from the cooking compartment.
2. Select the desired food from the recommended settings.
3. Place the food in suitable cookware.
4. Place the cookware in the middle on the cooking compartment floor.
The food can then absorb the microwaves from all sides.
5. Use the recommended settings when configuring the appliance settings.
Set the shorter cooking time first. If necessary, increase the cooking time.
6. Use an oven cloth or oven gloves when taking hot cookware out of the cooking compartment.

20.2 Defrosting, heating and cooking with the microwave

Recommended settings for defrosting, heating and cooking with the microwave.

The cooking time depends on the cookware, as well as on the temperature, composition and quantity of the food. This is why temperature ranges are given in the tables. Begin with the lower temperature and, if necessary, use a higher setting the next time. If you use different quantities than those specified in the table, adhere to the rule of thumb: Double the amount = almost double the time, half the amount = half the time.

Food	Weight	Microwave output	Cooking time
Whole pieces of meat, on the bone or boned ¹	1500 g	1. 180 W 2. 90 W	1. 20 min 2. 25-30 mins
Meat in pieces or slices ^{1,2}	200 g	1. 180 W 2. 90 W	1. 5-8 mins 2. 5-10 mins
Meat in pieces or slices ^{1,2}	500 g	1. 180 W 2. 90 W	1. 9 min 2. 10-15 mins
Meat in pieces or slices ^{1,2}	800 g	1. 180 W 2. 90 W	1. 10 min 2. 10-15 mins
Minced meat, mixed ^{1,2}	200 g	90 W	8-10 mins
Minced meat, mixed ^{1,2}	500 g	1. 180 W 2. 90 W	1. 3 min 2. 10-12 mins
Minced meat, mixed ^{1,2}	1000 g	1. 180 W 2. 90 W	1. 10 min 2. 15-17 mins
Poultry or poultry portions ^{1,2}	600 g	1. 180 W 2. 90 W	1. 8 min 2. 12-15 mins
Poultry or poultry portions ^{1,2}	1200 g	1. 180 W 2. 90 W	1. 15-20 mins 2. 15-20 mins
Fish fillet, fish steak or fish slices ^{1,2}	400 g	1. 180 W 2. 90 W	1. 3 min 2. 10-15 mins
Whole fish ¹	300 g	1. 180 W 2. 90 W	1. 3 min 2. 10-12 mins
Whole fish ¹	600 g	1. 180 W 2. 90 W	1. 8 min 2. 13-15 mins
Vegetables, e.g. peas ³	300 g	180 W	10-15 mins
Fruit, e.g. raspberries ³	300 g	180 W	6-9 mins
Fruit, e.g. raspberries ³	500 g	1. 180 W 2. 90 W	1. 6-8 mins 2. 5-10 mins
Butter, defrosting ⁴	125 g	1. 180 W 2. 90 W	1. 1 min 2. 1-2 mins
Butter, defrosting ⁴	250 g	1. 180 W 2. 90 W	1. 1 min 2. 2-4 mins
Loaf of bread ¹	500 g	1. 180 W 2. 90 W	1. 5 min 2. 5-10 mins
Loaf of bread ¹	1000 g	1. 180 W 2. 90 W	1. 8 min 2. 9-10 mins
Cakes, plain, e.g. sponge cake ^{5,6}	500 g	90 W	8-10 mins
Cakes, plain, e.g. sponge cake ^{5,6}	750 g	1. 180 W 2. 90 W	1. 3-5 mins 2. 6 min
Cakes, moist, e.g. fruit flan, cheesecake ⁵	500 g	1. 180 W 2. 90 W	1. 3 min 2. 10-15 mins
Cakes, moist, e.g. fruit flan, cheesecake ⁵	750 g	1. 180 W 2. 90 W	1. 5 min 2. 10-15 mins

¹ Turn the food several times.

² Separate any defrosted parts when turning.

³ Carefully stir the food occasionally.

⁴ Remove all packaging.

⁵ Only defrost cakes without icing, whipped cream, gelatine or custard.

⁶ Separate the pieces of cake.

Heating up or cooking frozen food with the microwave

Observe the recommended settings for using the microwave to heat food.

Note:

Cooking tips

- Use microwave-safe cookware with a lid. You can also use a plate or a microwave cover to cover the dish. Take ready meals out of the packaging.

- Distribute the food flat in the cookware. Food which lies flat cooks more quickly than food which is piled high.
- Place the cookware on the bottom of the cooking compartment.
- The food transfers heat to the cookware. The cookware can become very hot. Use oven gloves.
- Turn or stir the food several times during cooking.
- After cooking, leave the food to rest for 2 to 5 minutes.
- The food will retain most of its natural flavor. Use salt and seasonings sparingly.
- Take lasagne out of the packaging and place in microwave-safe cookware.
- Best suited is frozen Lasagne with a maximum height of around 3 cm.
- To achieve best results, we recommend that you reheat food or ready meals at 600 watts. If the packaging specifies a higher microwave output setting, extend the time.

Food	Weight	Microwave output setting	Cooking time
Menu, plated meal, ready meal (2-3 components)	300-400 g	600 W	8-13 mins
Soup	400 g	600 W	8-12 mins
Stews	500 g	600 W	10-15 mins
Slices or pieces of meat in sauce, e.g. goulash	500 g	600 W	10-15 mins
Fish, e.g. fillet steaks ¹	400 g	600 W	10-15 mins
Bakes, e.g. lasagne, cannelloni (approx. 3 cm deep)	450 g	600 W	12-15 mins
Side dishes, e.g. rice, pasta ¹	250 g	600 W	3-7 mins
Side dishes, e.g. rice, pasta ¹	500 g	600 W	8-12 mins
Vegetables, e.g. peas, broccoli, carrots ¹	300 g	600 W	7-10 mins
Vegetables, e.g. peas, broccoli, carrots ¹	600 g	600 W	14-17 mins
Creamed spinach ²	450 g	600 W	9-12 mins

¹ Add a little liquid to the food.

² Cook the food without any additional water.

Tips on defrosting, heating and cooking with the microwave next time

Follow these tips for good results when defrosting, heating and cooking with the microwave.

Issue	Tip
Your food is too dry.	<ul style="list-style-type: none"> ▪ Reduce the cooking time or select a lower microwave power setting. ▪ Cover the food and add more liquid.

Issue	Tip
The time has elapsed but the food is not defrosted, hot or cooked.	Increase the cooking time. Large quantities and food which is piled high require longer times.
The time has elapsed but your food is not yet done on the inside, but is already overdone on the outside.	<ul style="list-style-type: none"> ▪ Stir occasionally. ▪ Reduce the microwave power setting and increase the cooking time.
After defrosting, the poultry or meat is defrosted on the outside but not defrosted in the middle.	<ul style="list-style-type: none"> ▪ Reduce the microwave power setting. ▪ Turn large pieces of frozen food several times.

20.3 Heating

With your appliance you can heat food.

Heating food in the microwave

Observe the recommended settings for using the microwave to heat food.

⚠ WARNING – Risk of scalding!

There is a possibility of delayed boiling when a liquid is heated. This means that the liquid reaches the boiling temperature without the usual steam bubbles rising to the surface. Exercise caution even when only gently shaking the container. The hot liquid may suddenly boil over and splatter.

- ▶ Always place a spoon in the container when heating liquids. This prevents delayed boiling.

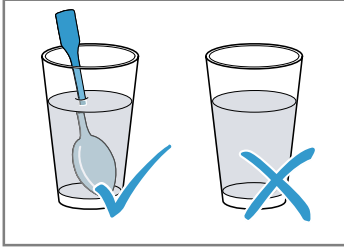

ATTENTION!

Metal touching the wall of the cooking compartment will cause sparks, which may damage the appliance or the inner door pane.

- ▶ Metal (e.g. a spoon in a glass) must be kept at least 2 cm from the cooking compartment walls and the inside of the door.

Note:

Cooking tips

- Use microwave-safe cookware with a lid. You can also use a plate or a microwave cover to cover the dish. Take ready meals out of the packaging.
- Place the cookware on the bottom of the cooking compartment.
- Turn or stir the food several times during cooking.
- After cooking, leave the food to rest for 2 to 5 minutes.
- The food transfers heat to the cookware. The cookware can become very hot. Use oven gloves.
- To achieve best results, we recommend that you re-heat food or ready meals at 600 watts. If the packaging specifies a higher microwave output setting, extend the time.

Food	Weight	Microwave output setting	Cooking time
Plated meal, chilled	1 portion	600 W	5-8 mins
Beverages ^{1, 2, 3}	125 ml	boost	40-50 secs
Beverages ^{1, 2, 3}	200 ml	boost	1-2 mins
Beverages ^{1, 2, 3}	500 ml	boost	2-3 mins
Baby food, e.g. baby bottles ^{4, 5, 3}	50 ml	600 W	Approx. 20-30 secs
Baby food, e.g. baby bottles ^{4, 5, 3}	100 ml	600 W	30-40 secs
Baby food, e.g. baby bottles ^{4, 5, 3}	200 ml	600 W	50-60 secs
Soup, 1 cup ⁶	175 g each	600 W	2-3 mins
Soup, 2 cups ⁶	175 g each	600 W	3-4 mins
Meat in sauce ⁷	500 g	600 W	7-10 mins
Stew ⁶	400 g	600 W	4-5 mins
Stew ⁶	800 g	600 W	7-8 mins
Vegetables, 1 portion ⁶	150 g	600 W	2-3 mins
Vegetables, 2 portions ⁶	300 g	600 W	3-4 mins

¹ Place a spoon in the glass.

² Do not overheat alcoholic drinks.

³ Always check the temperature.

⁴ Heat up baby food without the teat or lid.

⁵ Always shake the food well after heating.

⁶ Check the food occasionally.

⁷ Separate the slices of meat.

20.4 Cooking

With your appliance you can cook food.

Cooking with the microwave

Note:

Cooking tips

- Place the cookware on the bottom of the cooking compartment.
- Distribute the food flat in the cookware. Food which lies flat cooks more quickly than food which is piled high.

- Use microwave-safe cookware with a lid. You can also use a plate or a microwave cover to cover the dish. Take ready meals out of the packaging.
- The food will retain most of its natural flavor. Use salt and seasonings sparingly.
- After cooking, leave the food to rest for 2 to 5 minutes.
- The food transfers heat to the cookware. The cookware can become very hot. Use oven gloves.
- To achieve best results, we recommend that you reheat food or ready meals at 600 watts. If the packaging specifies a higher microwave output setting, extend the time.

Food	Weight	Microwave output setting	Cooking time
Whole chicken, fresh, without giblets ¹	1200 g	600 W	25 – 30 min.
Fish fillet, fresh ²	400 g	600 W	6 – 11 min.
Vegetables, fresh ^{3, 2, 4}	250 g	600 W	5 – 9 min.
Vegetables, fresh ^{3, 2, 4}	500 g	600 W	10 – 15 min.
Potatoes ^{3, 2, 4}	250 g	600 W	7 – 9 min.
Potatoes ^{3, 2, 4}	500 g	600 W	10 – 12 min.
Potatoes ^{3, 2, 4}	750 g	600 W	15 – 20 min.
Rice ^{5, 4}	125 g	1. 600 W 2. 180 W	1. 4 – 5 min. 1. 12 – 15 min.
Rice ^{5, 4}	250 g	1. 600 W 2. 180 W	1. 6 – 8 min. 1. 15 – 18 min.
Desserts, e.g. blancmange (instant) ⁴	500 ml	600 W	5 – 8 min.
Fruit compote ⁴	500 g	600 W	9 – 12 min.

¹ Turn the dish halfway through the cooking time.

² Add a little liquid to the food.

³ Cut into pieces of equal size.

⁴ Carefully stir the food occasionally.

⁵ Add double the amount of liquid.

Blancmange made from blancmange powder

WARNING – Risk of burns!

Heated food gives off heat. The cookware may become hot.

- ▶ Always use oven gloves to remove cookware or accessories from the cooking compartment.

1. Mix together one packet of blancmange powder with sugar and a little milk in a tall microwave-suitable bowl in accordance with the package instructions so that there are no lumps.

2. Add the rest of the milk and stir again.
3. Place the bowl into the cooking compartment and close the appliance door.
4. Set the appliance according to the recommended settings.
5. Only stir for the first time after 3 minutes. Then stir again every minute until it reaches the required consistency.
The cooking time depends on the temperature of the milk and the container that is used.

Microwave popcorn

WARNING – Risk of burns!

Airtight packaging may burst when food is heated.

- ▶ Always follow the instructions on the packaging.
- ▶ Always use oven gloves to remove the dishes from the cooking compartment.

ATTENTION!

If you prepare several bags of microwave popcorn in immediate succession at a microwave power level that is too high, the cooking compartment may be damaged.

- ▶ Leave the appliance to cool down for several minutes between each use.
- ▶ Never set a microwave power level that is too high.
- ▶ Use a maximum microwave output of 600 watts.

- ▶ Always place the popcorn bag on a glass plate.

Note:

Cooking tips

- Place the cookware on the bottom of the cooking compartment.
- Use shallow, heat-resistant glass ovenware. Do not use porcelain or deep plates.
- Place the popcorn bag onto the cookware with the labelled side facing downwards.
- Adjust the cooking time to the quantity.
- To prevent the popcorn from burning, after 1 minute 30 seconds, briefly take the popcorn bag out of the oven and shake it. Take care as the popcorn will be hot.

Food	Weight	Microwave output	Cooking time
Microwave popcorn ¹	1 bag, 100 g	600 W	2.5-3.5 mins

¹ Always place the popcorn bag on a glass plate. Follow the manufacturer's instructions.

20.5 Grilling

Grill food if you want it to be crispy.

Note:

Cooking tips

- Do not preheat.
- Use food to be grilled that is of a similar weight and thickness. This allows the food to be grilled to brown evenly and remain succulent and juicy.
- Place the food to be grilled directly on the wire rack. Place the wire rack in the glass tray. Any dripping fat and meat juices will be caught.
- Use grill tongs to turn the grilled items. If you pierce the meat with a fork, the juices will run out and it will become dry.
- Do not add salt until after the food has been grilled. Salt draws water from the meat.
- Dark meat, such as beef, browns more quickly than lighter-coloured meat, such as veal or pork. When grilling light-coloured meat or fish, these often only brown slightly on the surface, although they are cooked and juicy on the inside.
- The grill element switches on and off continuously. This is normal. The grill setting that you use determines how frequently this occurs.
- Smoke may be produced when grilling.

Food	Quantity	Weight	Grill setting	Cooking time
Neck steaks, approx. 2 cm thick	3-4	Approx. 220 g each	3 (high)	1st side: Approx. 15 mins 2nd side: Approx. 10-15 mins
Grilled sausages	4-6	Approx. 100 g each	3 (high)	1st side: Approx. 15-20 mins 2nd side: Approx. 10-15 mins
Fish steak ¹	2-3	Approx. 150 g each	3 (high)	1st side: Approx. 10 mins 2nd side: Approx. 15-20 mins

¹ Grease the wire rack with oil beforehand.

Food	Quantity	Weight	Grill setting	Cooking time
Fish, whole, e.g. trout ¹	2-3	Approx. 260 g each	3 (high)	1st side: Approx. 15 mins 2nd side: Approx. 10-15 mins
Toast (pretoast)	2-6 slices		3 (high)	1st side: Approx. 4-5 mins 2nd side: Approx. 2-3 mins
Toast with topping	2-6 slices		3 (high)	Depending on topping: 5-10 mins

¹ Grease the wire rack with oil beforehand.

20.6 Combining the grill and microwave

To reduce the cooking time, you can use the grill in combination with the microwave.

Combining the grill and microwave

Note:

Cooking tips

- Place the cookware onto the wire rack.
- For roasting, use a deep dish. If you cover the cookware when you cook your food, this will keep the cooking compartment cleaner.
- Arrange chicken, chicken portions and duck breast skin side up.
- Prick the skin here and there with a fork.
- For bakes and gratins, use large, flat cookware.
Food takes longer to cook in narrow, deep cookware and browns more on top.
- Leave bakes and gratins to stand for 5 minutes in the appliance after it has been switched off.
- Check whether the cookware fits in the cooking compartment. The cookware should not be too big.
- Leave the meat to sit for 5-10 minutes before carving.
This allows the meat juices to be distributed evenly so that they do not run out when the meat is carved.
- Always set the maximum cooking time.
Check the food after the shorter time specified.
- Take lasagne out of the packaging and place in microwave-safe cookware.
- If you are preparing frozen lasagne with an approx. height of 4-5cm, place the dish on an upturned, microwave-safe plate.

Food	Weight	Grill setting	Microwave output setting	Cooking time
Joint of pork, e.g. neck steak ¹	Approx. 750 g	1 (low)	360 W	35-40 mins
Meat loaf, max. 7 cm deep	Approx. 750 g	2 (medium)	360 W	20-25 mins
Chicken, halved ²	Approx. 1200 g	3 (high)	360 W	35-40 mins
Chicken pieces, e.g. chicken quarters ²	Approx. 800 g	2 (medium)	360 W	20-25 mins
Duck breast ²	Approx. 800 g	3 (high)	180 W	20-25 mins
Pasta bake (made from pre-cooked ingredients) ³	Approx. 1000 g	1 (low)	360 W	25-30 mins
Lasagne, frozen (approx. 3 cm deep)	350-450 g	3 (high)	360 W	12-15 mins
Lasagne, frozen (approx. 4-5 cm deep)	600-1000 g	3 (high)	360 W	25-30 mins

¹ Turn after 15 minutes.

² Do not turn the food.

³ Sprinkle cheese over the food.

Food	Weight	Grill setting	Microwave output setting	Cooking time
Potato gratin (made from raw potatoes), max. 3 cm deep	Approx. 1000 g	2 (medium)	360 W	25-30 mins
Fish, gratinated	Approx. 600 g	3 (high)	360 W	15 mins
Baked quark, max. 5 cm deep	Approx. 850 g	1 (low)	360 W	20-25 mins

¹ Turn after 15 minutes.

² Do not turn the food.

³ Sprinkle cheese over the food.

20.7 Test dishes

These overviews have been produced for test institutes to facilitate appliance testing in accordance with EN 60350-1:2013 or IEC 60350-1:2011 and EN 60705:2012, IEC 60705:2010.

Cooking with the microwave

Food	Microwave power setting in W	Cooking time in mins	Note:
Custard, 1000 g	1. 600 W 2. 180 W	1. 11-12 mins 2. 8-10 mins	Pyrex dish
Sponge, 475 g	600 W	7-9 mins	Pyrex dish, 22 cm diameter
Meat loaf, 900 g	600 W	20-25 mins	Pyrex dish, 28 cm diameter, long
Plated meal, chilled, 1 portion	600 W	5-6 mins	Microwaveable cover

Defrosting with the microwave

Food	Microwave power setting in W	Cooking time in mins	Note:
Meat, 500 g	1. 180 W 2. 90 W	1. 5-6 mins 2. 7-10 mins	Pyrex dish, 24 cm diameter

Cooking with the microwave and grill

Food	Microwave power setting in W	Cooking time in mins	Note:
Potato gratin, 1100 g	360 W + grill setting 2	25-35 mins	Round Pyrex dish, 22 cm diameter
Cakes	-		Not recommended

21 Installation instructions

Observe this information when installing the appliance.



21.1 Scope of delivery

After unpacking all parts, check for any damage in transit and completeness of the delivery.

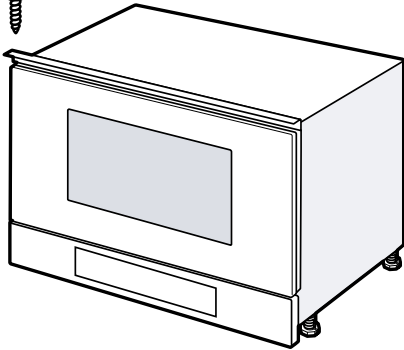

21.2 Safe installation

Follow these safety instructions when installing the appliance.

- The appliance can only be used safely if it is correctly installed according to the safety instructions. The installer is responsible for ensuring that the appliance works perfectly at its installation location.
- Check the appliance for damage after unpacking it. Do not connect the appliance if it has been damaged in transit.
- Before starting up the appliance, remove any packaging material and adhesive film from the cooking compartment and the door.
- Proceed in accordance with the installation sheets for installing accessories.
- Fitted units must be heat-resistant up to 95 °C, and adjacent unit fronts up to 70 °C.
- Do not install the appliance behind a decorative door or the door of a kitchen unit. There is a risk of overheating.
- Cut-out work on the units should be carried out before installing the appliance. Remove any shavings. Otherwise, the correct operation of electrical components may be adversely affected.
- Only a licensed professional may connect appliances without plugs. Damage caused by incorrect connection is not covered under the warranty.

WARNING – Risk of injury!

Parts that are accessible during installation may have sharp edges and may lead to cutting injuries.

- ▶ Wear protective gloves.

WARNING – Risk of fire!

It is dangerous to use an extended power cord and non-approved adapters.

- ▶ Do not use extension cables or multiple socket strips.
- ▶ Only use adapters and power cords approved by the manufacturer.
- ▶ If the power cord is too short and a longer one is not available, please contact an electrician to have the domestic installation adapted.

21.3 Fitted units

This appliance is only intended to be fully fitted in a kitchen. This appliance is not intended to be used as a tabletop appliance or within a cupboard. The installation cabinet must not have a back panel behind the appliance. The minimum installation height is 850 mm.

Ventilation slots and intakes must not be covered. The appliance must be securely fitted once it is installed and must not tip over.

21.4 Electrical connection

In order to safely connect the appliance to the electrical system, follow these instructions.

- The appliance corresponds to protection class I and must only be operated with a protective earth connection.
- The fuse protection must correspond to the power rating specified on the appliance's rating plate and to the local regulations.
- The appliance must be disconnected from the power supply whenever installation work is being carried out.
- The appliance must only be connected using the power cable provided.
- The power cable must be plugged in at the rear of the appliance. A 5 m power cable can be obtained from customer service.
- The power cable must only be replaced with a cable from the original manufacturer. This is available from customer service.

Connecting the appliance to the electricity supply

Note: The appliance must only be connected to a protective contact socket that has been correctly installed.

1. Insert the non-heating appliance plug of the power cable into the appliance. Check that the non-heating appliance plug is inserted properly.
2. Insert the mains plug of the appliance into a nearby socket.

When the appliance is installed, the mains plug of the power cable must be freely accessible. If free access to the mains plug is impossible, an all-pole isolating switch must be integrated into the permanent electrical installation in accordance with the installation regulations.

21.5 Installation in an upper cabinet

Observe the installation dimensions and the safety clearances in a tall unit.

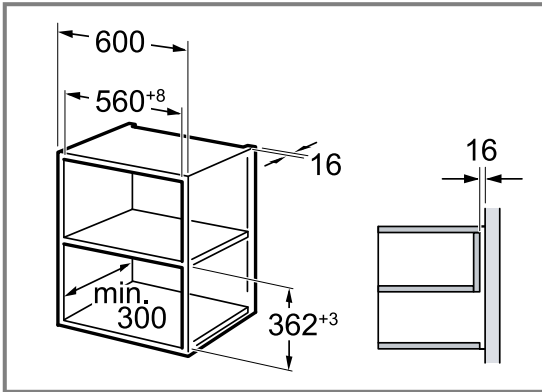

Do not fit the appliance too high up; it must be possible for accessories to be removed easily. Remove the feet.

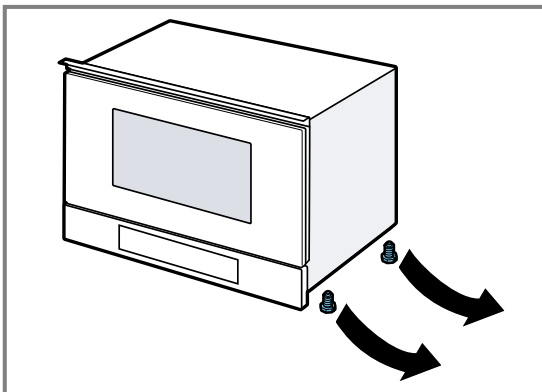

21.6 Installation in a tall unit

Observe the installation dimensions and the safety clearances in a tall unit.

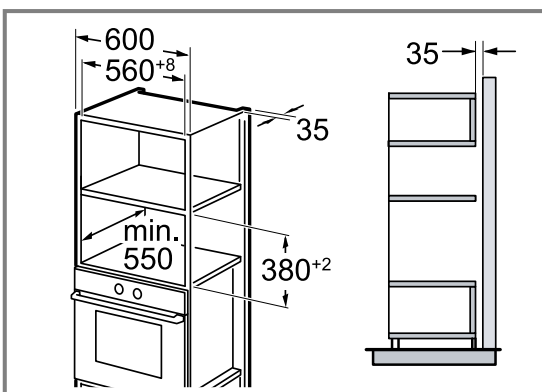

Do not fit the appliance too high up; it must be possible for accessories to be removed easily.

Fit the feet.

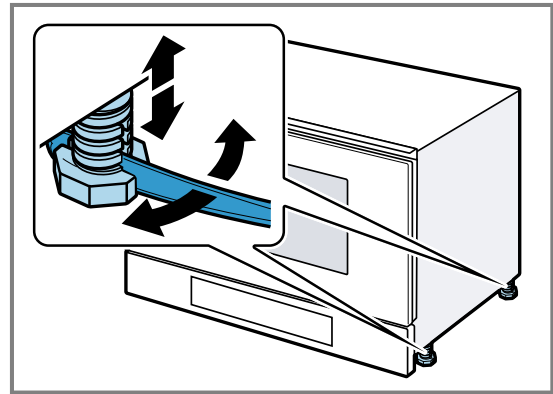

21.7 Installing the appliance

1. Push the appliance in fully.

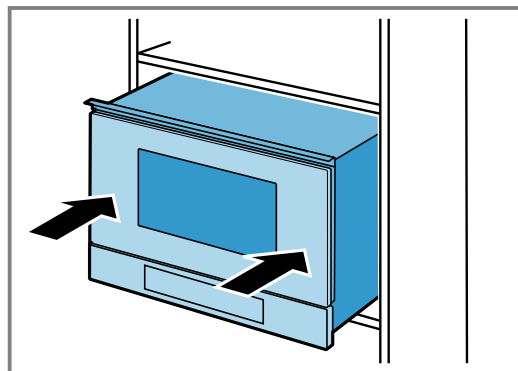

Do not kink or trap the connection cable, or route it over sharp edges.

2. Check the clearance to the adjacent appliances.

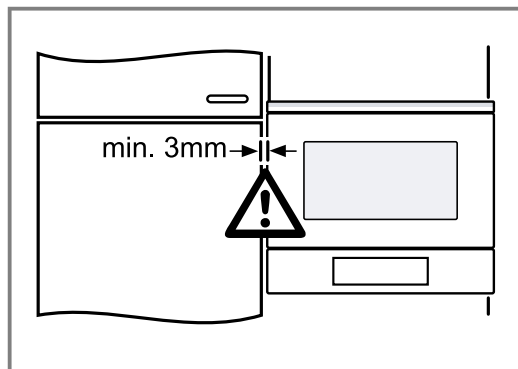

3. ATTENTION!

When opening the appliance door, the appliance may tilt forwards.

- ▶ Hold the appliance in position when opening the appliance door.

Open the appliance door slowly.

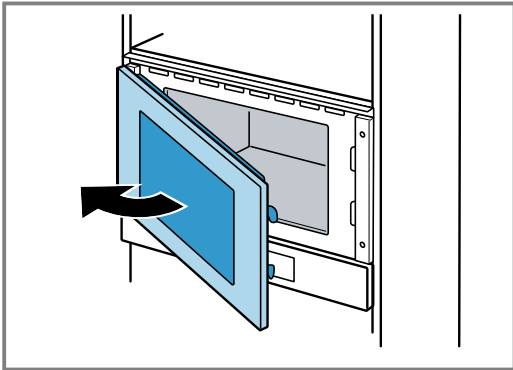

- 4.** Screw the appliance to the unit on the opposite side to the hinges.

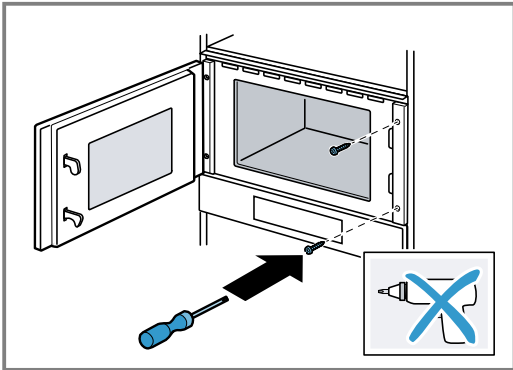

- 5.** Pre-drill the screw holes in the unit on the side with the hinges.

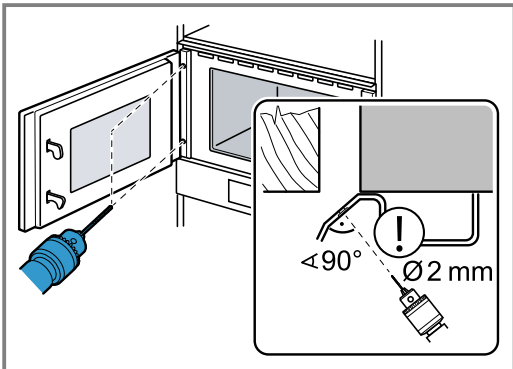

Cover the door hinges.
Use a wood drill with a 2 mm diameter.

- 6.** Remove any shavings from the cooking compartment.

- 7.** Screw the appliance to the unit on the side with the hinges.

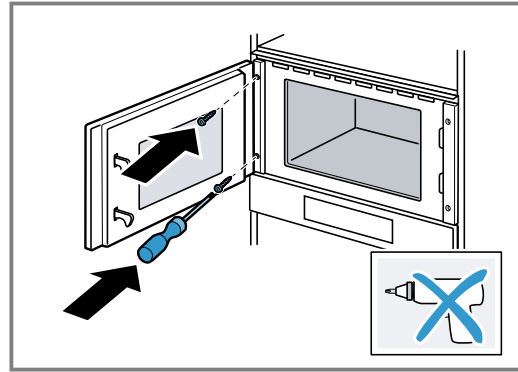

- 8.** Remove any packaging material and adhesive film from the cooking compartment and the door.

21.8 For handleless kitchens with vertical bar handle strips:

- 1.** Attach a suitable filling piece on both sides in order to cover any sharp edges and to guarantee safe installation.

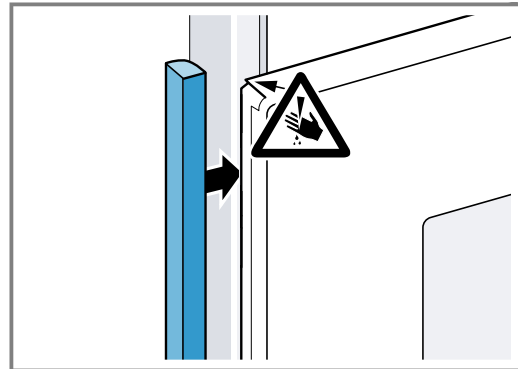

- 2.** Secure the filling piece to the unit.
3. Pre-drill the filling piece and the unit to establish a screw connection.

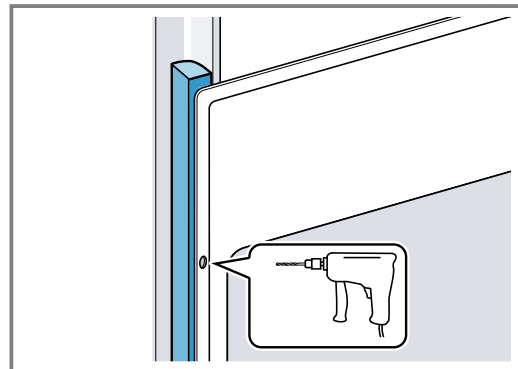

4. Secure the appliance using a suitable screw.

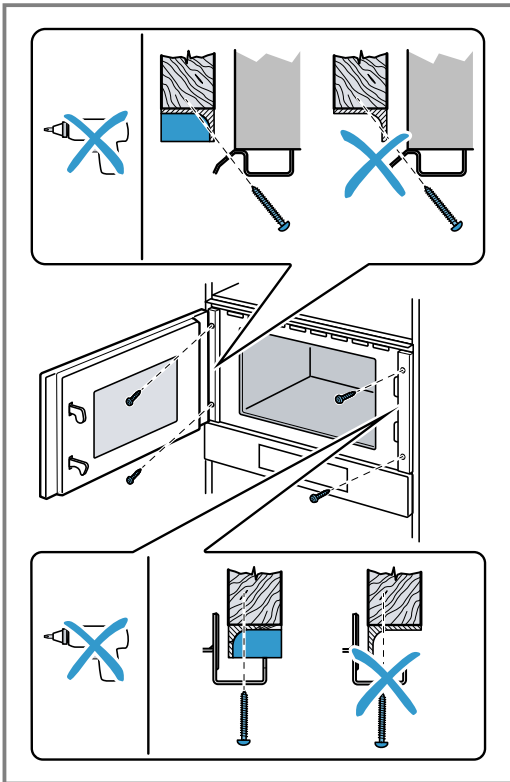

21.9 Removing the appliance

1. Disconnect the appliance from the power supply.
2. Undo the fastening screws.
3. Lift the appliance slightly and pull it out completely.



Thank you for buying a Bosch Home Appliance!

Register your new device on MyBosch now and profit directly from:

- **Expert tips & tricks for your appliance**
- **Warranty extension options**
- **Discounts for accessories & spare-parts**
- **Digital manual and all appliance data at hand**
- **Easy access to Bosch Home Appliances Service**

Free and easy registration – also on mobile phones:

www.bosch-home.com/welcome

BOSCH
HOME APPLIANCES
SERVICE

Looking for help? You'll find it here.

Expert advice for your Bosch home appliances, help with problems or a repair from Bosch experts.

Find out everything about the many ways Bosch can support you:

www.bosch-home.com/service

Contact data of all countries are listed in the attached service directory.

BSH Hausgeräte GmbH

Carl-Wery-Straße 34
81739 München, GERMANY
www.bosch-home.com

A Bosch Company



9001768151 (040409)

en

Valid within Great Britain:
Imported to Great Britain by
BSH Home Appliances Ltd.
Grand Union House
Old Wolverton Road
Wolverton, Milton Keynes
MK12 5PT
United Kingdom