

SIEMENS

WP41G0XZA

Tumble dryer



EN User manual and installation instructions



Further information and explanations are available online:



Table of contents

1 Safety	4	9 Accessories.....	27
1.1 General information.....	4	10 Laundry.....	27
1.2 Intended use.....	4	10.1 Preparing the laundry.....	27
1.3 Restriction on user group.....	4	11 Basic operation	28
1.4 Safe installation	5	11.1 Switching on the appliance... ..	28
1.5 Safe use	7	11.2 Setting a programme	28
1.6 Safe cleaning and maintenance.....	9	11.3 Adjusting the programme settings	28
2 Preventing material damage	11	11.4 Loading laundry.....	28
3 Environmental protection and saving energy.....	11	11.5 Starting the programme	28
3.1 Disposing of packaging	11	11.6 Adding laundry	28
3.2 Saving energy.....	11	11.7 Cancelling the programme... ..	29
3.3 Energy saving mode	12	11.8 Unloading the laundry	29
4 Installation and connection	12	11.9 Switching off the appliance... ..	29
4.1 Unpacking the appliance	12	11.10 Fluff filter.....	29
4.2 Contents of package.....	12	11.11 Condensation container	30
4.3 Requirements for the installation location	13	12 Dryness level.....	31
4.4 Water drain hose	13	12.1 Changing the dryness level... ..	32
4.5 Aligning the appliance.....	16	12.2 Adjusting the dryness level	32
4.6 Connecting the appliance to the electricity supply.....	16	13 Childproof lock.....	32
5 Familiarising yourself with your appliance.....	17	13.1 Activating the childproof lock.....	32
5.1 Appliance	17	13.2 Deactivating the childproof lock.....	32
5.2 Control panel.....	18	14 Basic settings.....	32
6 Display	19	14.1 Overview of the basic settings.....	32
7 Buttons	21	14.2 Changing the basic settings.....	33
8 Programmes	24	15 Cleaning and servicing	33
8.1 Automatic programmes.....	24	15.1 Base unit	33
8.2 Timed programmes.....	25	15.2 Moisture sensor.....	35

16 Troubleshooting.....	37
17 Transportation, storage and disposal	41
17.1 Disposing of old appliance ...	41
18 Customer Service.....	41
18.1 Product number (E-Nr.) and production number (FD).....	41
19 Consumption values.....	42
20 Technical data	43



1 Safety

Observe the following safety instructions.

1.1 General information



- Read this instruction manual carefully.
- Keep the instruction manual and the product information safe for future reference or for the next owner.
- Do not connect the appliance if it has been damaged in transit.

1.2 Intended use

Only use this appliance:

- for drying and freshening up fabrics that are washed with water and suitable for dryers.
- in private households and in enclosed spaces in a domestic environment.
- up to an altitude of max. 4000 m above sea level.

1.3 Restriction on user group

This appliance may be used by children aged 8 or over and by people who have reduced physical, sensory or mental abilities or inadequate experience and/or knowledge, provided that they are supervised or have been instructed on how to use the appliance safely and have understood the resulting dangers.

Do not let children play with the appliance.

Cleaning and user maintenance must not be performed by children unless they are being supervised.

Keep children under the age of 3 years and pets away from the appliance.

1.4 Safe installation

WARNING – Risk of electric shock!

Incorrect installation is dangerous.

- ▶ Connect and operate the appliance only in accordance with the specifications on the rating plate.
- ▶ Connect the appliance to a power supply with alternating current only via a properly installed socket with earthing.
- ▶ The protective conductor system of the domestic electrical installation must be properly installed. The installation must have a sufficiently large cross section.
- ▶ When using a residual current circuit breaker, only use a type with the  mark.
- ▶ Never equip the appliance with an external switching device, e.g. a timer or remote control.
- ▶ Never connect the appliance to a circuit that is regularly switched on and off by the energy supplier.
- ▶ When the appliance is installed, the mains plug of the power cord must be freely accessible. If free access is not possible, an all-pole isolating switch must be installed in the permanent electrical installation according to the installation regulations.
- ▶ When installing the appliance, check that the power cable is not trapped or damaged.

If the insulation of the power cord is damaged, this is dangerous.

- ▶ Never let the power cord come into contact with hot appliance parts or heat sources.
- ▶ Never let the power cord come into contact with sharp points or edges.
- ▶ Never kink, crush or modify the power cord.

WARNING – Risk of fire!

It is dangerous to use an extended power cord and non-approved adapters.

- ▶ Do not use extension cables or multiple socket strips.
- ▶ Only use adapters and power cords approved by the manufacturer.

- ▶ If the power cord is too short and a longer one is not available, please contact an electrician to have the domestic installation adapted.

⚠ WARNING – Risk of injury!

The heavy weight of the appliance may result in injury when lifted.

- ▶ Do not lift the appliance on your own.

If this appliance is not correctly installed in a washer-dryer stack, the installed appliance may fall.

- ▶ Only stack the dryer on a washing machine using the connection kit from the dryer manufacturer
→ *"Accessories", Page 27*. No other installation method is permitted.
- ▶ Do not install the appliance in a washer-dryer stack if the dryer manufacturer does not offer a suitable connection kit.
- ▶ Do not install appliances from different manufacturers and with varying depths and widths in a washer-dryer stack.
- ▶ Do not install a washer-dryer stack on a platform; the appliances may tip over.

⚠ WARNING – Risk of suffocation!

Children may put packaging material over their heads or wrap themselves up in it and suffocate.

- ▶ Keep packaging material away from children.
- ▶ Do not let children play with packaging material.

⚠ CAUTION – Risk of injury!

The appliance may vibrate or move when in use.

- ▶ Place the appliance on a clean, even, solid surface.
- ▶ Align the appliance using the appliance feet and a spirit level.

If hoses and power cords have been laid incorrectly, this causes a tripping hazard.

- ▶ Lay hoses and power cords in such a way that there is no risk of tripping.

If the appliance is moved by holding onto protruding components, such as the appliance door, the parts may break off.

- ▶ Do not move the appliance by holding onto protruding parts.

⚠ CAUTION – Risk of cutting!

Touching sharp edges on the appliance may lead to cuts.

- ▶ Do not touch the sharp edges on the appliance.
- ▶ Wear protective gloves when installing and transporting the appliance.

1.5 Safe use**⚠ WARNING – Risk of electric shock!**

If the appliance or the power cord is damaged, this is dangerous.

- ▶ Never operate a damaged appliance.
- ▶ Never pull on the power cord to unplug the appliance. Always unplug the appliance at the mains.
- ▶ If the appliance or the power cord is damaged, immediately unplug the power cord or switch off the fuse in the fuse box.
- ▶ Call customer services. → *Page 41*

An ingress of moisture can cause an electric shock.

- ▶ Only use the appliance in enclosed spaces.
- ▶ Never expose the appliance to intense heat or humidity.
- ▶ Do not use steam- or high-pressure cleaners, hoses or sprays to clean the appliance.

⚠ WARNING – Risk of harm to health!

Children can lock themselves in the appliance, thereby putting their lives at risk.

- ▶ Do not install the appliance behind a door as this may obstruct the appliance door or prevent it from opening.
- ▶ With redundant appliances, unplug the power cord. Then cut through the cord and damage the lock on the appliance door beyond repair so that the appliance door will no longer close.

⚠ WARNING – Risk of suffocation!

Children may breathe in or swallow small parts, causing them to suffocate.

- ▶ Keep small parts away from children.
- ▶ Do not let children play with small parts.

⚠ WARNING – Risk of explosion!

If there is coal dust or flour in the air around the appliance, this may cause an explosion.

- ▶ Keep the area around the appliance clean during operation.

⚠ WARNING – Risk of poisoning!

Condensation water from this appliance is not suitable for drinking and may be contaminated with fluff.

- ▶ Do not drink or reuse the condensation water from the appliance.

Detergents and care products may result in poisoning if consumed.

- ▶ If accidentally swallowed, seek medical advice.
- ▶ Keep detergents and care products out of the reach of children.

⚠ WARNING – Risk of explosion!

If there is any residual material left in the fluff filter, this may ignite during the drying process.

- ▶ Clean the fluff filter regularly.

Highly flammable objects such as lighters or matches may ignite during the drying process.

- ▶ Remove all highly flammable objects from any pockets in your laundry before the drying process.

Unwashed laundry that has come into contact with solvents, oil, wax, wax remover, paint, grease or stain remover may ignite when drying is in progress.

- ▶ Do not place laundry in this appliance to be dried if the laundry has not been washed first.
- ▶ Rinse the laundry thoroughly with warm water and detergent before drying it in the machine.
- ▶ Do not use the appliance if industrial chemicals have been used to clean the laundry beforehand.

⚠ WARNING – Risk of fire!

If drying is interrupted early, the laundry is not cooled sufficiently and may ignite.

- ▶ Do not interrupt the drying programme early.

- ▶ If drying is interrupted early, remove the laundry immediately and spread it out.

⚠ CAUTION – Risk of injury!

The covering plate may break if you stand on or climb onto the appliance.

- ▶ Do not stand on or climb onto the appliance.

The appliance may tip over if you sit on or lean against the open door.

- ▶ Do not sit on or lean against the appliance door.
- ▶ Do not place any objects on the appliance door.

Reaching into the drum while it is still turning may cause hand injuries.

- ▶ Wait for the drum to come to a complete stop before reaching inside.

⚠ CAUTION – Risk of burns!

The rear panel of the appliance becomes hot during operation.

- ▶ Do not touch the rear panel of the appliance when it is hot.
- ▶ Keep children away from the rear panel of the appliance when it is hot.
- ▶ Position the appliance with the rear panel close against a wall.

1.6 Safe cleaning and maintenance

⚠ WARNING – Risk of electric shock!

Improper repairs are dangerous.

- ▶ Never make any technical modifications to the appliance or its features.
- ▶ Repairs to the appliance should only be carried out by trained specialist staff.
- ▶ Only use genuine spare parts when repairing the appliance.
- ▶ If the power cord of this appliance is damaged, it must be replaced by the manufacturer, the manufacturer's Customer Service or a similarly qualified person in order to prevent any risk.

An ingress of moisture can cause an electric shock.

- ▶ Before cleaning, pull out the mains plug or switch off the fuse in the fuse box.

- ▶ Do not use steam- or high-pressure cleaners, hoses or sprays to clean the appliance.

⚠ WARNING – Risk of injury!

The use of non-original spare parts and non-original accessories is dangerous.

- ▶ Only use the manufacturer's original spare parts and original accessories.

⚠ WARNING – Risk of poisoning!

Poisonous fumes may be given off if you use cleaning agents that contain solvents.

- ▶ Do not use cleaning agents that contain solvents.

2 Preventing material damage

ATTENTION!

The functionality of the appliance may be impaired if you use the wrong quantity of fabric softener, detergent, care product or cleaning agent.

- ▶ Follow the dosage recommendations from the manufacturer.

Exceeding the maximum load capacity impairs the function of the appliance.

- ▶ Observe the maximum load capacity for each programme and do not exceed it.

→ "Programmes", Page 24

The function of the appliance may be impaired if the appliance overheats.

- ▶ Keep the ventilation opening on the appliance clear during operation.
- ▶ Make sure that the area is adequately ventilated.

Light objects such as hair and fluff may be sucked in from the ventilation opening on the appliance during operation and impair the function of the appliance.

- ▶ Keep the area around the appliance clean during operation.
- ▶ Keep light objects away from the appliance.

If you operate the appliance without a fluff guard (e.g. fluff filter, fluff collector, filter mat, etc., depending on appliance specifications), or if the fluff guard is incomplete or defective, this may result in damage to the appliance.

- ▶ Do not operate the appliance without a fluff guard, or with a fluff guard that is incomplete or defective.

Foam and foam rubber may deform or melt during the drying process.

- ▶ Do not dry laundry that contains foam or foam rubber.

Unsuitable cleaning products may damage the surfaces of the appliance.

- ▶ Do not use harsh or abrasive detergents.
- ▶ Do not use cleaning products with a high alcohol content.
- ▶ Do not use hard scouring pads or cleaning sponges.
- ▶ Clean the appliance with nothing but water and a soft, damp cloth.
- ▶ Remove all detergent residue, spray residue or other residues immediately if they come into contact with the appliance.

3 Environmental protection and saving energy

3.1 Disposing of packaging

The packaging materials are environmentally compatible and can be recycled.

- ▶ Sort the individual components by type and dispose of them separately.

3.2 Saving energy

If you follow these instructions, your appliance will use less power.

Operate the appliance in a well-ventilated room and keep the ventilation opening on the appliance clear.

- ✓ If air exchange is impeded, this extends the programme duration and increases energy consumption.

Spin the laundry in the washing machine before drying.

- ✓ Damper laundry extends the programme duration and increases energy consumption.

Observe the programme's maximum load capacity.

→ "Programmes", Page 24

- ✓ If the maximum load is exceeded, this extends the programme duration and increases energy consumption.

After drying, clean the fluff filter

→ Page 29.

- ✓ If the fluff filter is dirty, this reduces the air flow in the appliance, extends the programme duration and increases energy consumption.

Regularly clean the base unit

→ Page 34.

- ✓ If the heat exchanger is dirty, this extends the programme duration and increases energy consumption.

3.3 Energy saving mode

If you do not use the appliance for an extended period, it automatically switches to energy-saving mode. All displays go out and  **Start/Reload** flashes.

Energy-saving mode ends when you use the appliance again.

4 Installation and connection

4.1 Unpacking the appliance

ATTENTION!

Objects remaining in the drum that are not designed for operation with the appliance may cause material damage and damage to the appliance.

- ▶ Remove these objects, along with all supplied accessories, from the drum before starting the appliance.

1. Remove any packaging and protective covers completely from the appliance.

→ "Disposing of packaging", Page 11

2. Check the appliance for visible damage.
3. Open the door.
4. Remove any accessories from the drum.
5. Close the door.

4.2 Contents of package

After unpacking all parts, check for any damage in transit and completeness of the delivery.

ATTENTION!

If the appliance is operated with incomplete or defective accessories, the appliance may not be able to operate properly, or this may result in material damage or damage to the appliance.

- ▶ Do not operate the appliance with incomplete or defective accessories.

- ▶ Replace the accessories in question before operating the appliance.
→ "Accessories", Page 27

The delivery consists of the following:

- Tumble dryer
- Accompanying documents
- Water drain hose with connection adapter, fixing material and elbow.
→ "Water drain hose", Page 13

4.3 Requirements for the installation location

ATTENTION!

If the appliance is tilted at an angle greater than 40°, residual water may leak out of the appliance and cause material damage.

- ▶ Tilt the appliance carefully.
- ▶ Transport the appliance in an upright position.

If residual water in the appliance freezes, this may cause damage to the appliance.

- ▶ Do not install or operate this appliance anywhere that is liable to experience frost or outdoors.

Installation location	Requirements
On the floor	Place the appliance on a clean, level and firm surface. Align the appliance → Page 16.

Installation location	Requirements
-----------------------	--------------

In a washer-dryer stack

Only use the original connection set from the dryer manufacturer when setting up this appliance in a washer-dryer stack.

- Connection kit
→ Page 27

This appliance must only be stacked on a washing machine from the same manufacturer.

The depth and width of this appliance must correspond with the dimensions of the washing machine.

Do not place the washer-dryer stack on a platform.

Against a wall

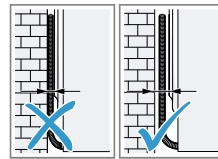

Do not trap the hoses and power cord between the wall and the appliance.

4.4 Water drain hose

Condensation that forms in the appliance as it dries the laundry is collected by default in the condensation

en Installation and connection

container. Use the water drain hose to drain away excess condensation directly into the waste water system.

Note

- Operate this appliance using the water outlet hose provided.
→ *"Connecting the water drain hose", Page 14*
If you connect the water outlet hose, you do not have to regularly empty the condensation container.
→ *"Emptying the condensation container", Page 31*

Connecting the water drain hose

If you do not want to regularly empty the appliance's condensation container, connect the water outlet hose.

ATTENTION!

When operating the appliance without the condensation hose or water drain hose being connected properly, liquid may leak out of the connecting piece.

- ▶ Before operating the appliance, connect the condensation hose or water drain hose properly to the connecting piece.

Requirements

- The appliance and the accessory have been unpacked.
→ *"Unpacking the appliance", Page 12*
- The appliance is installed at the installation location.
→ *"Requirements for the installation location", Page 13*

1. Pull out the condensation hose from the connecting piece.

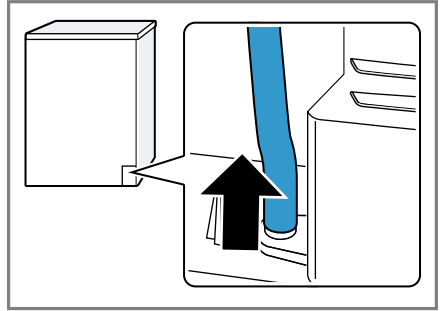

The condensation hose is connected to the connecting piece at the factory.

Note: When removing the condensation hose, liquid may leak out of the connecting piece.

2. Push the condensation hose into the holder.

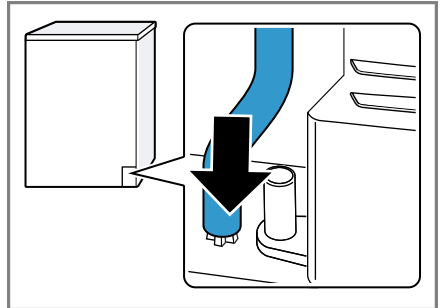

3. Push the water drain hose as far as it will go into the connecting piece.

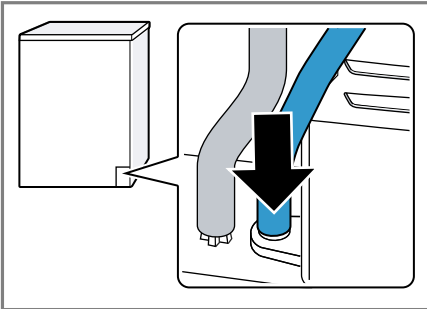

4. Insert the water drain hose into the hose guide.

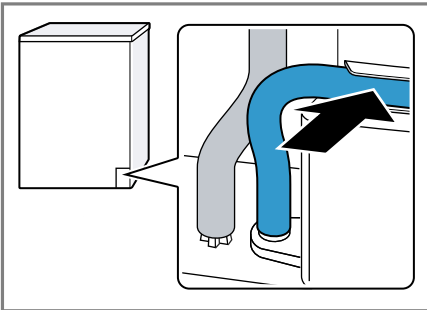

Ensure that you do not bend the water drain hose.

5. Empty the condensation container.
→ "Emptying the condensation container", Page 31
6. Insert the condensation container.
→ "Inserting the condensation container", Page 31
7. Connect the appliance to the water outlet.
→ "Water outlet connection types", Page 15

Tip: To collect condensation in the condensation container again (e.g. if you change where the appliance is located), carry out these steps in reverse order.

Water outlet connection types

ATTENTION!

In the event of a blocked or covered outlet, accumulated wastewater can flow back into the appliance.

- ▶ Before operating the appliance, ensure that the wastewater drains away quickly and eliminate any blockages.

Drainage into a siphon.

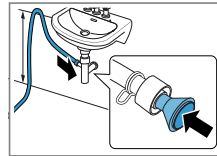

Secure the connection point with a (12-22 mm) hose clamp. Secure the water outlet hose with a hose guide at a height of at least 80 cm and no more than 100 cm.

Note: You can use the Y-distributor → Page 27 to connect the water drain hose of an additional appliance, such as a washing machine, to the same siphon outlet.

Drainage into a wash basin.

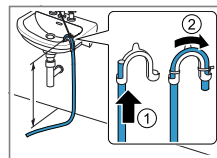

Push the water drain hose fully through the elbow and secure it using fixing material. Secure the elbow at a height of no more than 100 cm.

Drainage into a gully.

Push the water drain hose fully through the el-

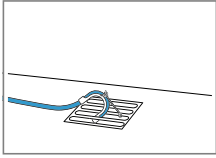

bow and secure it using fixing material. Secure the elbow to the gully.

4.5 Aligning the appliance

In order to reduce vibrations and noises, align the appliance correctly.

- ▶ To align the appliance, turn the appliance feet. Check that the appliance is level using a spirit level.

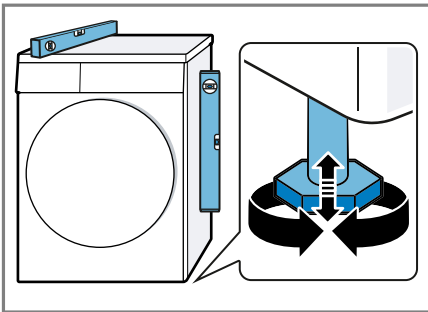

All appliance feet must stand firmly on the ground.

4.6 Connecting the appliance to the electricity supply

1. Insert the mains plug of the appliance's power cable in a socket nearby.

The connection details of the appliance can be found under Technical data → *Page 43*.

2. Check the mains plug is inserted properly.

5 Familiarising yourself with your appliance

5.1 Appliance

You can find an overview of the parts of your appliance here.



On certain models, specific details such as the colour and shape may differ from those pictured.

1	Ventilation opening	4	Door
2	Maintenance flap on the base unit → <i>Page 33</i>	5	Condensation container → <i>Page 30</i>
3	Fluff filter → <i>Page 29</i>	6	Control panel → <i>Page 18</i>

5.2 Control panel

You can use the control panel to configure all functions of your appliance and to obtain information about the operating status.

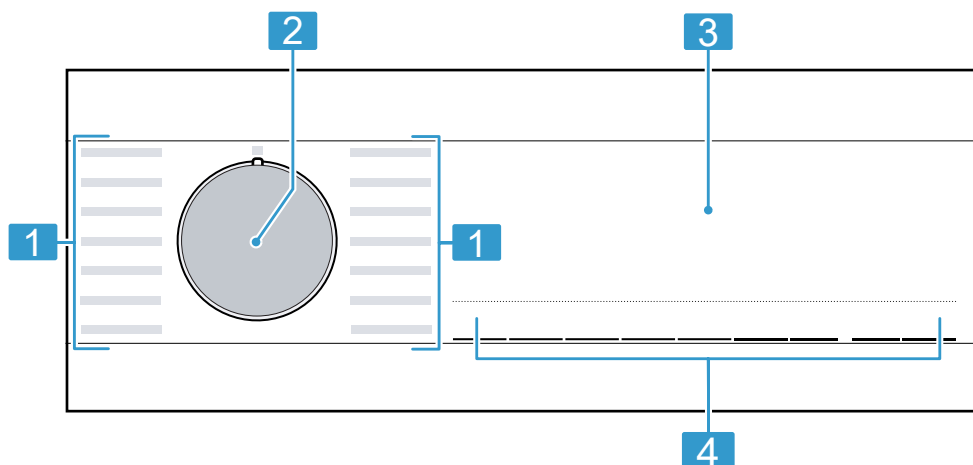

1 Programmes → *Page 24*

2 Programme selector
→ *Page 28*

3 Display → *Page 19*

4 Buttons → *Page 21*













6 Display

The display shows the current settings, options or relevant information.







Display	Description
0:40 ¹	Expected programme duration or programme time remaining in hours and minutes.
1:25	The timed programme is set. → "Timed programmes", Page 25
9.0 ¹	Recommendation for the maximum load capacity for the selected program in kg.
+ 0:45 ¹	Program end time → "Buttons", Page 23
	<ul style="list-style-type: none"> ■ Lights up: The childproof lock is activated. ■ Flashes: The childproof lock is activated and the appliance has been operated. → "Deactivating the childproof lock", Page 32
	Start, cancel or pause <ul style="list-style-type: none"> ■ Lights up: The programme is running and can be cancelled or paused. ■ Flashes: The programme can be started or continued.
	The dryness level is activated. → "Buttons", Page 22
	The dryness level is activated. → "Buttons", Page 22









¹ Example



Display	Description
 *	The dryness level is activated. → "Buttons", Page 21
+1 +2 +3	The adjusted dryness level is activated. → "Dryness level", Page 31
	The crease-reduction function is activated. → "Buttons", Page 22
	Gentle drying is activated for delicate fabrics. → "Buttons", Page 22
 4.5 kg	Half load is activated. → "Buttons", Page 23
	Quiet drying with no signal tones is activated. → "Buttons", Page 23
	Empty and insert the condensation container. → "Emptying the condensation container", Page 31
	Clean the fluff filter. → "Cleaning the fluff filter", Page 29 Clean the base unit. → "Base unit", Page 33
Hot	The cooling process cools the laundry for a few minutes while the drum is rotating, in order to avoid damage to the laundry. The cooling process can be cancelled by opening the door. Note: Do not change the set programme.
	Programme status: Drying
	Programme status: Iron dry dryness level
	Programme status: Cupboard Dry dryness level
	Programme status: Crease-reduction function
	Programme status: Pause
End	Programme status: Programme end
¹ Example	

7 Buttons

Below is an overview of the buttons and their setting options.

Button	Selection	Description
 Start/Reload	<ul style="list-style-type: none"> ■ Start ■ Cancel ■ Pause 	Start, cancel or pause the programme.
 3 s	<ul style="list-style-type: none"> ■ Activate ■ Deactivate 	<p>Activate or deactivate the childproof lock.</p> <p>Disable the control panel to prevent unwanted or accidental operation.</p> <p>If the childproof lock is activated and the appliance has been switched off, the childproof lock remains activated.</p> <p>→ <i>"Childproof lock", Page 32</i></p>
 Cupboard dry plus	<ul style="list-style-type: none"> ■  Cupboard dry plus ■ +1 ■ +2 ■ +3 	<ul style="list-style-type: none"> ■ Selecting  Cupboard dry plus activates the dryness level. The dryness level defines how damp or dry the laundry is after the programme ends. → <i>"Dryness level", Page 31</i> ■ The dryness level can be adjusted by selecting +1, +2 or +3. → <i>"Adjusting the dryness level", Page 32</i>

Button	Selection	Description
 Cupboard dry	<ul style="list-style-type: none"> ■  Cupboard dry ■ +1 ■ +2 ■ +3 	<ul style="list-style-type: none"> ■ Selecting  Cupboard dry activates the dryness level. The dryness level defines how damp or dry the laundry is after the programme ends. → "Dryness level", Page 31 ■ The dryness level can be adjusted by selecting +1, +2 or +3. → "Adjusting the dryness level", Page 32
 Iron dry	<ul style="list-style-type: none"> ■  Iron dry ■ +1 ■ +2 ■ +3 	<ul style="list-style-type: none"> ■ Selecting  Iron dry activates the dryness level. The dryness level defines how damp or dry the laundry is after the programme ends. → "Dryness level", Page 31 ■ The dryness level can be adjusted by selecting +1, +2 or +3. → "Adjusting the dryness level", Page 32
 Anticrease	<ul style="list-style-type: none"> ■ Activate ■ Deactivate 	<p>Activate or deactivate the crease-reduction function. Once the programme has ended, the drum moves the laundry at regular intervals for 120 minutes to prevent creasing.</p>
 Gentle	<ul style="list-style-type: none"> ■ Activate ■ Deactivate 	<p>Activate or deactivate gentle drying. The temperature is reduced for delicate fabrics, e.g. polyacrylic or elastane. The programme duration is extended.</p>

Button	Selection	Description
 Ready in	<ul style="list-style-type: none"> ■ Programme end time ■ Programme duration 	<ul style="list-style-type: none"> ■ Set the programme end time. The programme duration is already included in the set number of hours. Once the programme has started, the programme duration is displayed. ■ Set the programme duration for timed programmes. → <i>"Timed programmes", Page 25</i>
 Signal	<ul style="list-style-type: none"> ■ Activate ■ Deactivate 	Activate or deactivate operating signals and information signals.
 Half Load	<ul style="list-style-type: none"> ■ Activate ■ Deactivate 	Dry individual items of laundry or small loads of laundry.

8 Programmes

You can dry your fabrics using either an automatic programme or a timed programme.











8.1 Automatic programmes



Automatic programmes are programmes in which humidity sensors measure the residual moisture in the laundry during the drying cycle. The programme only ends once the set dryness level is reached.

Each automatic programme has a dryness level → *Page 31*. The dryness level defines how dry or damp the laundry is after the programme ends.

Tips

- Select the dryness level according to the type of fabric or the desired drying result.
→ *"Dryness level", Page 31*
- The laundry's care labels provide you with additional information about programme selection.



Programme	Description	Max. load (kg)
Cottons 	Dry hard-wearing, heat-resistant fabrics made of cotton or linen.	9.0
Cottons eco   	Dry hard-wearing, heat-resistant fabrics made of cotton or linen. Energy-saving programme.	9.0
Easy-care 	Dry items made of synthetic materials or blended fabrics.	3.5
Mix 	Dry items made of cotton and synthetics.	3.0
 Duvet/Blanket	Dry clothing, pillows, quilts or bedspreads filled with synthetic fibres. Note: Dry large items of laundry, blankets or pillows individually.	2.5
Lingerie 	Dry delicate underwear made of lace, Ly-cra, satin or blended fabrics.	2.0
 Hygiene	Dry hard-wearing, heat-resistant fabrics made of cotton or linen. Note: Particularly suitable for strict hygiene requirements.	4.0
 Outdoor	Dry weatherproof and outdoor clothing with a membrane coating and water-repellent fabrics.	1.5

Programme	Description	Max. load (kg)
 Shirts 15'	Suitable for shirts and blouses made of cotton, linen, synthetics or blended fabrics. Note: For optimal drying results, dry a maximum of 5 shirts or 5 blouses at the same time. Once the laundry is dry, iron it or hang it up. The residual moisture is then distributed evenly.	1.5
 Rapid 40'	Dry items made of synthetics and light cotton.	2.0
 Towels	Dry hard-wearing, heat-resistant towels and dressing gowns made of cotton or linen.	6.0

8.2 Timed programmes

Timed programmes are programmes with a defined or adjustable programme duration. The programme ends once this time has elapsed, even if the laundry is still not dry, for example. Timed programmes are suitable for drying individual items of laundry or thin fabrics.

Tip: The laundry's care labels provide you with additional information about programme selection.

Programme	Description	Max. load (kg)
 Wool finish	Dry machine-washable items made of wool or containing wool. Note: The laundry becomes fluffier but not dry. Remove laundry once the programme has ended and allow it to dry.	0.5
Time program cold 	Fluff/loosen all fabric types except for wool and silk. This programme is suitable for fluffing dry laundry only. Also suitable for freshening up or airing dry clothing that has hardly been worn. Note: This programme is suitable for drying using the wool basket.	3.0

Programme	Description	Max. load (kg)
 Time program warm	<p>Dry all types of fabric except for wool and silk.</p> <p>Suitable for pre-dried or slightly damp laundry and for drying off multi-layered, thick laundry.</p> <p>Note: This programme is suitable for drying using the wool basket.</p> <p>If you are using the wool basket, you can also dry fabrics made from wool using this programme.</p>	3.0

9 Accessories

Use original accessories. These have been made especially for your appliance.

Note: Some accessories are available in other colours. Contact → "Customer Service", Page 41.

	Use	Order number
Connection kit	To save space, stack the appliance on a suitable washing machine of the same width and depth and that is from the same manufacturer.	WZ1141X
Wool basket	Dry or air individual woollen items, sports shoes and soft toys.	WZ20600
Y-distributor	Connect the water drain hose of an additional appliance to the same siphon outlet.	15000490
Water drain hose	Drain away excess condensation directly into the waste water system, without having to regularly empty the condensation container.	WZ20160

10 Laundry

10.1 Preparing the laundry

ATTENTION!

Objects remaining in the laundry may damage the laundry and the drum.

- ▶ Remove all items from any pockets in your laundry before using the appliance.

Note

The appliance and fabrics are protected when you prepare your laundry.

- Brush off sand and soil
- Sort the laundry according to colour and textiles and observe the care labels
- Close all zips, hook and loop fasteners, hooks and eyes
- Remove curtain fittings and lead strips
- Load the laundry unfolded into the drum
- Spin the laundry before drying

- Dry woollen items, sports shoes and soft toys in the wool basket

11 Basic operation

11.1 Switching on the appliance

Requirement: The appliance has been correctly installed and connected.

→ *"Installation and connection", Page 12*

- ▶ Turn the programme selector to a programme.

Note: The lighting for the drum goes out automatically.

11.2 Setting a programme

1. Turn the programme selector and set the required programme.
→ *"Programmes", Page 24*
2. If required, adjust the programme settings. → *Page 28*

11.3 Adjusting the programme settings

Depending on the programme and programme progress, you can adjust or activate/deactivate the settings.

Requirement: A programme is set.
→ *"Setting a programme", Page 28*

- ▶ Adjust the programme settings.
→ *"Buttons", Page 21*

Note: The programme settings are not saved permanently for the programme.

11.4 Loading laundry

Note: To prevent creasing, note the maximum load for the programmes.
→ *"Programmes", Page 24*

Requirements

- The laundry is prepared and sorted.
→ *"Laundry", Page 27*
- The drum is empty.

1. Open the door.
2. Place the laundry in the drum.
3. Close the door.
Ensure that there is no laundry trapped in the door.

11.5 Starting the programme

Requirement: A programme is set.
→ *"Setting a programme", Page 28*

- ▶ Press **▷** **Start/Reload**.
- ✓ The display shows the programme duration or the programme end time.
- ✓ After the programme has ended, the display shows: "End".

Note: If "Hot" appears, the appliance cools the laundry.
When "Hot" goes out, the laundry has cooled down.

11.6 Adding laundry

After the programme starts, you can remove or add laundry at any time.

1. Press **▷** **Start/Reload**.
The cooling process starts automatically after approximately 30 seconds and cools down the laundry while the drum is rotating. If you want to avoid or cancel the cooling process, open the door.
→ *"Display", Page 20*
2. Open the door.
3. Add or remove laundry.
4. Close the door.

5. Press  **Start/Reload**.

11.7 Cancelling the programme

1. Press  **Start/Reload**.
2. Open the door.
3. Remove the laundry. → *Page 29*

11.8 Unloading the laundry

1. Open the door.
2. Remove the laundry from the drum.

11.9 Switching off the appliance

- ▶ Turn the programme selector to .

11.10 Fluff filter

During drying, fluff from the laundry is collected in the fluff filter. The fluff filter protects the appliance from fluff.

Cleaning the fluff filter

If the drying programme has finished or the display shows a notification while the appliance is in operation, clean the fluff filter.

Note: If you do not clean the appliance as described, the appliance's functionality may be impaired.

Requirements

- The display shows the following after drying: "End"
- or the display shows the following during operation: .

1. Open the door.

2. Remove the fluff from the door.

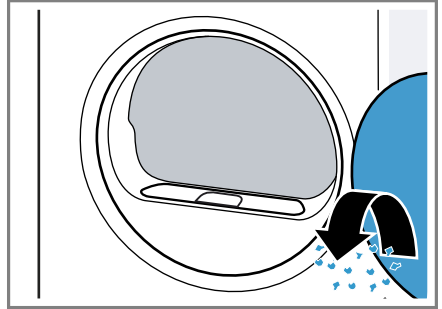

3. Remove the fluff filter.

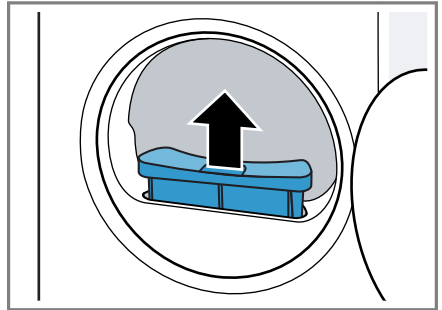

4. Remove the fluff from the recess.

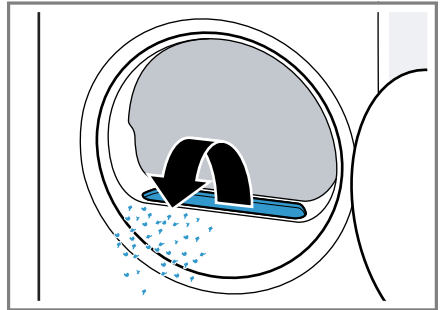

Ensure that no fluff falls into the air channel.

en Basic operation

5. Open the fluff filter.

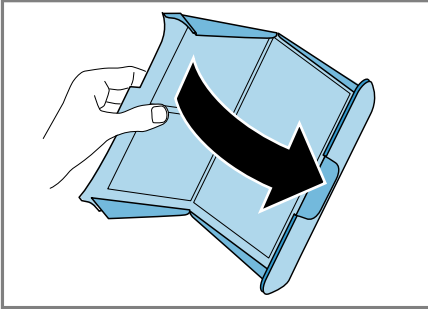

6. Remove the fluff.

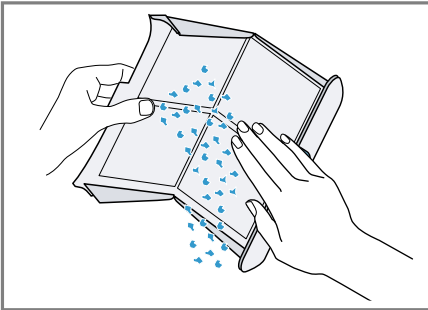

7. Clean the fluff filter thoroughly under warm, running water and then dry it off.

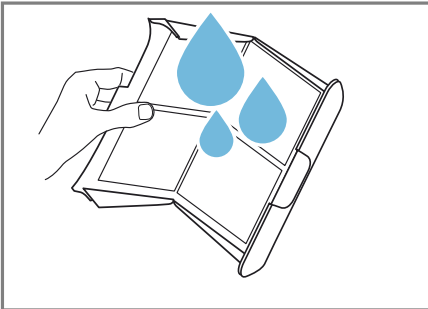

8. Close the fluff filter.

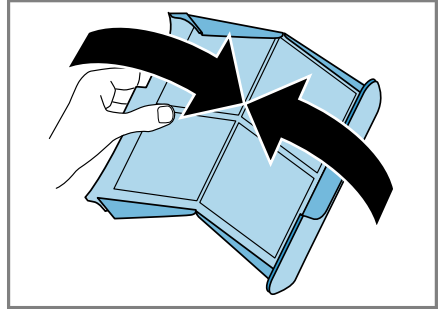

9. Insert the fluff filter.

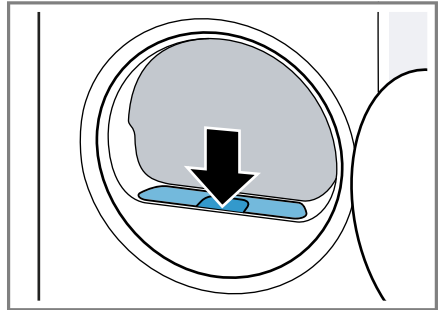

10. Close the door.

11.11 Condensation container

Condensation that forms in the appliance as it dries the laundry is collected by default in the condensation container.

Note: Operate this appliance using the water outlet hose provided.
→ "Connecting the water drain hose", Page 14

If you connect the water outlet hose, you do not have to regularly empty the condensation container.
→ "Emptying the condensation container", Page 31

Emptying the condensation container

If the drying programme has finished or the display shows a notification while the appliance is in operation, empty the condensation container.

Requirements

- The display shows the following after drying: "End"
 - or the display shows the following during operation: 
1. Pull out the condensation container, keeping it level.

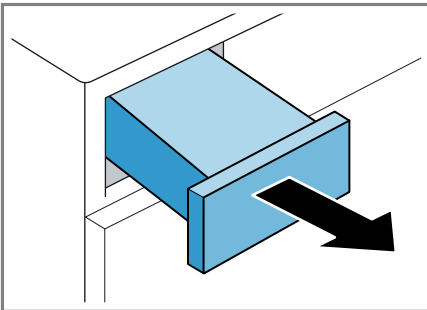

2. Empty the condensation container.

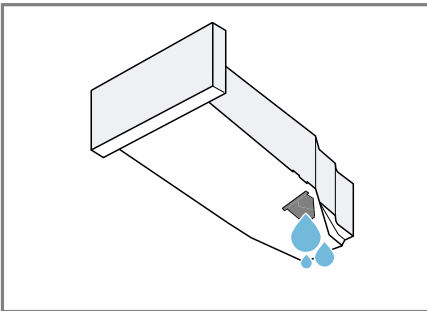

Make sure that you insert the condensation container before operating the appliance.

→ "Inserting the condensation container", Page 31

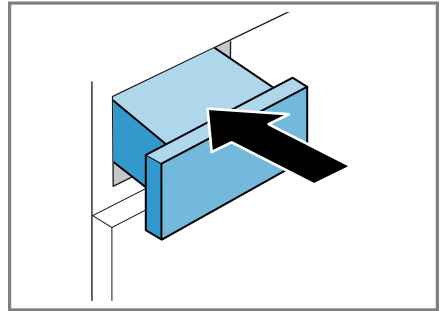

Inserting the condensation container

- ▶ Push the condensation container in as far as it will go.



12 Dryness level

Each automatic programme has a specified dryness level. The dryness level defines how dry or damp your laundry is after the programme ends.

Dryness level	Description
 * Cupboard dry plus	For multi-layered, thick laundry that does not dry readily.
 Cupboard dry	For normal, single-layered laundry.
 Iron dry	For normal, single-layered laundry. The laundry is still slightly damp after the programme ends. To prevent creasing after drying, iron the laundry or hang it up.

12.1 Changing the dryness level

For some automatic programmes, you can change the dryness level so that your laundry will be drier or more damp.

1. Set an automatic programme.
→ Page 24
- ✓ The display shows the specified dryness level.
2. Press **Cupboard dry**, **Cupboard dry plus** or **Iron dry**.
- ✓ The display shows **+**, **+** or **+**.

12.2 Adjusting the dryness level

If the laundry feels too damp after it has been dried to a particular dryness level, you can adjust the dryness level.

1. Set an automatic programme.
→ Page 24
- ✓ The display shows the specified dryness level.
2. Press **Cupboard dry**, **Cupboard dry plus** or **Iron dry**.
3. Press the set drying target again to adjust the dryness level.
- ✓ The display shows "+1", "+2" or "+3".

13 Childproof lock

Secure your appliance against being operated unintentionally using the controls.

13.1 Activating the childproof lock

- ▶ Press on both **3 s** buttons for approx. three seconds.
- ✓ The display shows **☞**.

- ✓ The control elements are locked.
- ✓ The childproof lock remains active even after the appliance has been switched off and in the event of a power cut.

13.2 Deactivating the childproof lock

Requirement: To deactivate the childproof lock, the appliance must be switched on.

- ▶ Press on both **3 s** buttons for approx. three seconds.
So that the programme currently running is not cancelled, the programme selector must be set to the initial programme.
- ✓ **☞** goes out on the display.

14 Basic settings

You can configure the basic settings for your appliance to meet your needs.

14.1 Overview of the basic settings

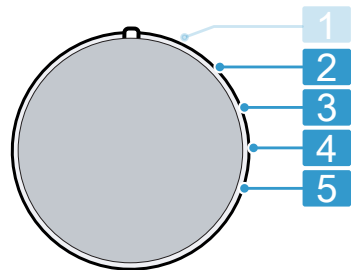

Programme selector with programme positions

2 Set the volume of the signal at the end of the programme: 0 (off) to 4 (very loud)

3 Set the volume of the signal tone emitted when the buttons are pressed: 0 (off) to 4 (very loud)



4 Set the minimum installation protection of the appliance to 10 A (LO) or 13 A (HI).

Note: The values for the energy label were determined with a minimum installation protection of 13 A. If the installation protection is changed to 10 A, the programme duration and energy consumption will be increased.

→ "Consumption values",
Page 42

5 Display the number of started programmes.

14.2 Changing the basic settings

1. Set the programme selector to position 1. → Page 32
2. Press  **Iron Dry** and, at the same time, turn the programme selector to position 2.
- ✓ The display shows the current value.
3. Use the programme selector to select the required basic setting.
→ Page 32
4. To change the value, press  **Ready in**.
5. To save the changes, switch off the appliance.

15 Cleaning and servicing

To keep your appliance working efficiently for a long time, it is important to clean and maintain it carefully.

15.1 Base unit

The base unit is the accessible area at the bottom of the appliance in which you will find the heat exchanger.

Opening the base unit

Requirements

- The appliance has cooled down for 30 minutes.
 - The appliance door is closed.
1. Open the maintenance flap.

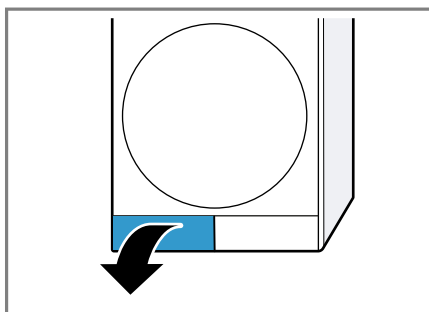

If you place a cloth beneath the maintenance flap, you can collect the remaining water from the base unit.

en Cleaning and servicing

2. Open the lever for the heat exchanger cover.

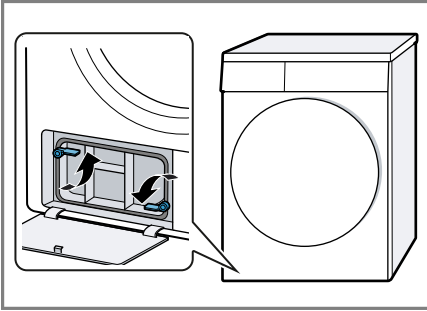

3. Pull out the heat exchanger cover by the handle.

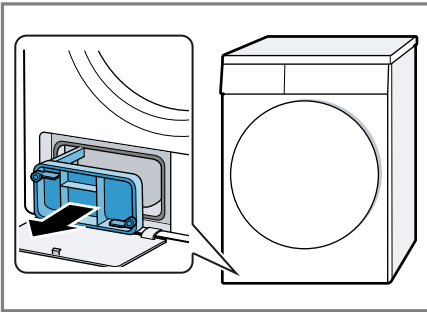

Cleaning the base unit

You can remove any visible dirt in the base unit.

ATTENTION!

Heavy or sharp objects may damage the heat exchanger.

- ▶ Do not use hard, sharp or rough objects for cleaning.

1. Open the base unit → Page 33.

2. Clean the heat exchanger cover under running water and dry it.

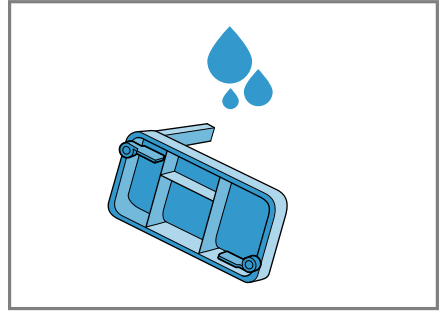

Make sure that you remove all dirt from the seal.

3. Pull out the heat exchanger horizontally.

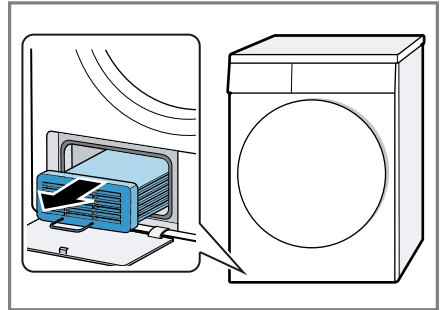

4. Clean the heat exchanger from all sides under running water and dry it.

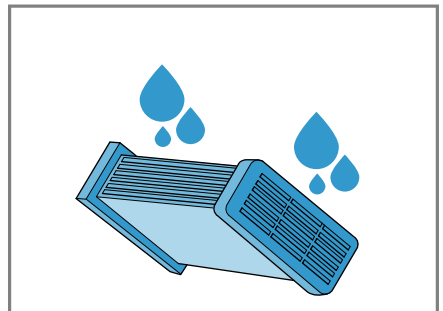

5. Clean the opening with a soft, damp cloth.

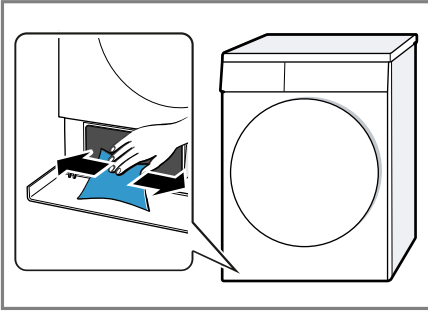

6. Slide the heat exchanger in horizontally as far as it will go.

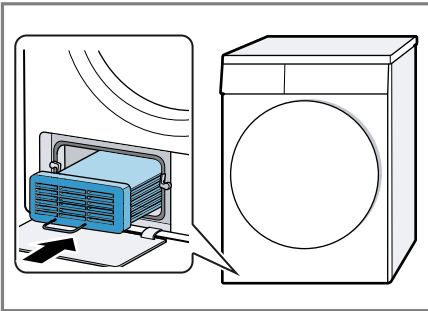

Ensure that the heat exchanger is inserted with its handle pointing downwards.

7. Close the base unit → *Page 35*.

Closing the base unit

Requirement: The base unit is open.
→ "Opening the base unit", *Page 33*

1. Insert the heat exchanger cover by the handle.

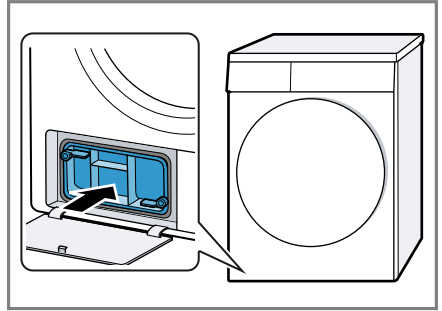

2. Close the lever for the heat exchanger.

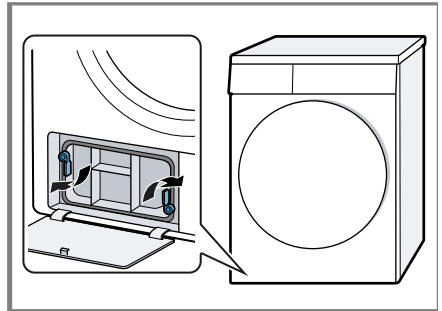

3. Close the maintenance flap.

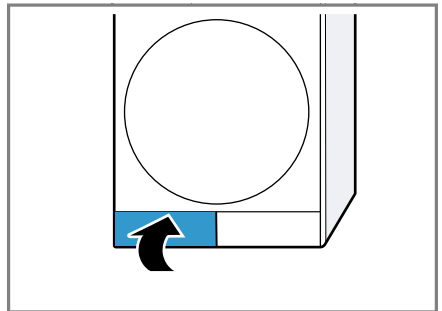

15.2 Moisture sensor

The moisture sensor in this appliance measures how damp the laundry is during the drying cycle. The appli-

en Cleaning and servicing

ance changes the duration of the automatic programme depending on the residual moisture in the laundry.

Cleaning the moisture sensor

Over time, residue from limescale, detergents and care products can build up on the moisture sensor. Clean the moisture sensor regularly.

ATTENTION!

Hard or rough objects may damage the moisture sensor.

- ▶ Do not use hard or rough objects, abrasive cleaning products or steel wool for cleaning.

Note: If you do not clean the appliance as described, the appliance's functionality may be impaired.

1. Open the door.
2. Clean the moisture sensor with a sponge.

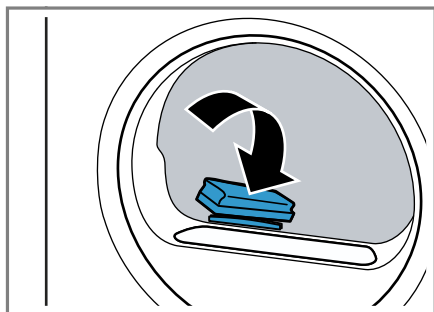

16 Troubleshooting



You can rectify minor faults on your appliance yourself. Read the troubleshooting information before contacting after-sales service. This will avoid unnecessary costs.

 **WARNING**

Risk of electric shock!

Incorrect repairs are dangerous.

- ▶ Repairs to the appliance should only be carried out by trained specialist staff.
- ▶ Only use genuine spare parts when repairing the appliance.
- ▶ If the power cord of this appliance is damaged, it must be replaced by the manufacturer, the manufacturer's Customer Service or a similarly qualified person in order to prevent any risk.

Fault	Cause and troubleshooting
"Hot" and the drum rotates.	<p>Cooling process active.</p> <ol style="list-style-type: none"> 1. Not a fault. 2. Do not change the programme during the cooling process. <p>Note: The cooling process takes up to 10 minutes. You can continue to operate the appliance.</p>
Humming noise.	<p>Compressor active.</p> <ul style="list-style-type: none"> ▶ Not a fault – normal operating noise.
The display goes out and  Start/Reload flashes.	<p>Energy-saving mode is active</p> <ul style="list-style-type: none"> ▶ Press any button. ✓ The display lights up again.
	<p>Fluff filter is soiled.</p> <ul style="list-style-type: none"> ▶ → "Cleaning the fluff filter", Page 29
The appliance is not working.	<p>The mains plug of the power cord is not plugged in.</p> <ul style="list-style-type: none"> ▶ Connect the appliance to the power supply. <hr/> <p>The circuit breaker in the fuse box has tripped.</p> <ul style="list-style-type: none"> ▶ Check the circuit breaker in the fuse box. <hr/> <p>There has been a power cut.</p> <ul style="list-style-type: none"> ▶ Check whether the lighting in your room or other appliances are working.
Appliance paused, but the drum is rotating.	<p>Cooling process active.</p> <ul style="list-style-type: none"> ▶ Not a fault – no action required.
Creasing.	<p>The load is too large.</p> <ul style="list-style-type: none"> ▶ Observe the maximum load capacity of the → "Programmes", Page 24.

Fault	Cause and troubleshooting
Creasing.	<p>The laundry lies in the drum for too long after drying.</p> <ol style="list-style-type: none"> 1. Remove the laundry from the drum as soon as the drying programme has finished. 2. Spread the items of laundry for cooling. <hr/> <p>Unsuitable programme for the type of fabric.</p> <ul style="list-style-type: none"> ▶ Set the suitable programme for the type of fabric. → <i>"Programmes"</i>, Page 24
	<p>Easy-Care fabrics are dried for too long.</p> <ul style="list-style-type: none"> ▶ → <i>"Changing the dryness level"</i>, Page 32. ▶ → <i>"Adjusting the dryness level"</i>, Page 32.
	<p>Crease-reduction function not activated.</p> <ul style="list-style-type: none"> ▶ Activate the crease-reduction function. → <i>"Buttons"</i>, Page 22
 and programme terminated.	<p>Condensation tank filled.</p> <ol style="list-style-type: none"> 1. → <i>"Emptying the condensation container"</i>, Page 31. 2. → <i>"Inserting the condensation container"</i>, Page 31. 3. → <i>"Starting the programme"</i>, Page 28.
	<p>Water drain hose is caught or jammed.</p> <ol style="list-style-type: none"> 1. Ensure that the water drain hose is not kinked or trapped. 2. Route the water drain hose without kinks.
	<p>Water drain hose is not connected correctly.</p> <ul style="list-style-type: none"> ▶ Ensure that the water drain hose is connected correctly. → <i>"Connecting the water drain hose"</i>, Page 14
	<p>Water drain hose is blocked.</p> <ul style="list-style-type: none"> ▶ Rinse the water drain hose with tap water.
	<p>Foreign object is located in the base unit</p> <ol style="list-style-type: none"> 1. → <i>"Opening the base unit"</i>, Page 33. 2. Remove the foreign objects that are present. 3. → <i>"Closing the base unit"</i>, Page 35.
<p>Condensation in the condensation tank even though the water drain hose is connected.</p>	<p>The remaining volume of condensation may remain in the condensation container.</p> <ul style="list-style-type: none"> ▶ Not a fault – no action required. <hr/> <p>Water drain hose is not connected correctly.</p> <ul style="list-style-type: none"> ▶ Ensure that the water drain hose is connected correctly. → <i>"Connecting the water drain hose"</i>, Page 14

Fault	Cause and troubleshooting
The programme does not start.	<p>Childproof lock is activated.</p> <ul style="list-style-type: none"> ▶ Deactivate childproof lock. → <i>"Deactivating the childproof lock", Page 32</i> <hr/> <p>▶ Start/Reload has not been pressed.</p> <ul style="list-style-type: none"> ▶ Press ▶ Start/Reload. <hr/> <p>Door is not closed.</p> <hr/> <p>No programme set.</p> <ol style="list-style-type: none"> 1. → <i>"Setting a programme", Page 28.</i> 2. → <i>"Starting the programme", Page 28.</i>
The length of the programme changes during the drying cycle.	<p>The programme operation is optimised electronically. This may change the programme duration.</p> <ul style="list-style-type: none"> ▶ Not a fault – no action required.
Pumping noise.	<p>Condensation pump active.</p> <ul style="list-style-type: none"> ▶ Not a fault – normal operating noise.
Buzzing noise.	<p>Compressor ventilation active.</p> <ul style="list-style-type: none"> ▶ Not a fault – normal operating noise.
The drying time is too long.	<p>Fluff filter is soiled.</p> <ul style="list-style-type: none"> ▶ → <i>"Cleaning the fluff filter", Page 29</i> <hr/> <p>The ambient temperature is greater than 30 °C.</p> <ul style="list-style-type: none"> ▶ Ensure that the ambient temperature is below 30 °C. <hr/> <p>The ambient temperature is lower than 15 °C.</p> <ul style="list-style-type: none"> ▶ Ensure that the ambient temperature is above 15 °C. <hr/> <p>Insufficient air circulation at the appliance's installation location.</p> <ul style="list-style-type: none"> ▶ Ventilate the appliance's installation location. <hr/> <p>The appliance's ventilation opening is blocked.</p> <ul style="list-style-type: none"> ▶ Ensure that the ventilation opening of the appliance is kept clear. <hr/> <p>Heat exchanger is soiled.</p> <ol style="list-style-type: none"> 1. Opening the base unit. → <i>"Opening the base unit", Page 33.</i> 2. Cleaning the heat exchanger. → <i>"Cleaning the base unit", Page 34.</i> 3. Closing the base unit. → <i>"Closing the base unit", Page 35.</i>
Water is leaking from the appliance.	<p>Appliance is not correctly aligned.</p> <ul style="list-style-type: none"> ▶ → <i>"Aligning the appliance", Page 16</i>

Fault	Cause and troubleshooting
Water is leaking from the appliance.	Water drain hose is not connected correctly. <ul style="list-style-type: none"> ▶ Ensure that the water drain hose is connected correctly. → <i>"Connecting the water drain hose", Page 14</i>
The laundry is too damp.	Unsuitable programme for the type of fabric. <ul style="list-style-type: none"> ▶ Set a timed programme for the subsequent drying. → <i>"Programmes", Page 24</i>
	There has been a power cut. <ul style="list-style-type: none"> ▶ Check whether the lighting in your room or other appliances are working.
	The load is too large. <ul style="list-style-type: none"> ▶ Observe the maximum load capacity of the → <i>"Programmes", Page 24.</i>
	After the end of the programme, warm laundry feels damper than it actually is. <ol style="list-style-type: none"> 1. Remove the laundry from the drum as soon as the drying programme has finished. 2. Spread the items of laundry for cooling.
	Unsuitable dryness level set. <ul style="list-style-type: none"> ▶ → <i>"Changing the dryness level", Page 32.</i>
	Drying target not adjusted. <ul style="list-style-type: none"> ▶ → <i>"Adjusting the dryness level", Page 32.</i>
	Load too small. <ul style="list-style-type: none"> ▶ Set a timed programme for the subsequent drying. → <i>"Programmes", Page 24</i>
	Moisture sensor dirty. <ul style="list-style-type: none"> ▶ → <i>"Cleaning the moisture sensor", Page 36.</i>
	The drying process is interrupted and the condensation tank has been filled. <ol style="list-style-type: none"> 1. → <i>"Emptying the condensation container", Page 31.</i> 2. → <i>"Inserting the condensation container", Page 31.</i> 3. → <i>"Starting the programme", Page 28.</i>

17 Transportation, storage and disposal

17.1 Disposing of old appliance

Valuable raw materials can be re-used by recycling.

WARNING

Risk of harm to health!

Children can lock themselves in the appliance, thereby putting their lives at risk.

- ▶ Do not install the appliance behind a door as this may obstruct the appliance door or prevent it from opening.
- ▶ With redundant appliances, unplug the power cord. Then cut through the cord and damage the lock on the appliance door beyond repair so that the appliance door will no longer close.

1. Unplug the appliance from the mains.
2. Cut through the power cord.
3. Dispose of the appliance in an environmentally friendly manner.

Information about current disposal methods are available from your specialist dealer or local authority.



This appliance is labelled in accordance with European Directive 2012/19/EU concerning used electrical and electronic appliances (waste electrical and electronic equipment - WEEE). The guideline determines the framework for the return and recycling

of used appliances as applicable throughout the EU.

18 Customer Service

Detailed information on the warranty period and terms of warranty in your country is available from our after-sales service, your retailer or on our website.

If you contact Customer Service, you will require the product number (E-Nr.) and the production number (FD) of your appliance.

The contact details for Customer Service can be found in the enclosed Customer Service directory or on our website.

18.1 Product number (E-Nr.) and production number (FD)

You can find the product number (E-Nr.) and the production number (FD) on the appliance's rating plate.

Depending on the model, the rating plate is located:

- On the inside of the door.
- On the inside of the maintenance flap.
- On the rear of the appliance.

Make a note of your appliance's details and the Customer Service telephone number to find them again quickly.



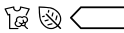











19 Consumption values

The **Cottons eco**  programme (denoted by the arrow symbol) is suitable for drying cotton laundry with a normal dampness level, and is the most efficient programme for drying damp cotton laundry in terms of combined energy consumption. The consumption values for this programme that are declared on the energy label refer to a moisture content of 60% of the laundry and a minimum installation protection of 13 A when it is delivered.















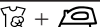

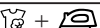

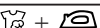

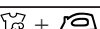
The values specified for other programmes are indicative only and were determined in accordance with the applicable standard EN61121.

The actual values may deviate from the indicated values depending on the type of fabric, composition of laundry to be dried, residual moisture in the fabric, set degree of dryness, amount of laundry being loaded, environmental conditions and the activation of additional functions.

The expected programme duration/"Ready in" time that is shown on the appliance display when selecting the programme is based on the spin speed in the washing machine of 1000 rpm when the appliance is delivered.

Programme	Final moisture level (%)	Load (kg)	Spin speed (rpm)	Initial moisture level (%)	Programme duration (h:min) ¹	Energy consumption (kWh/cycle) ¹
Cottons  +  Cupboard dry	-1.5	9.0	1400	50	02:50 / 02:35	4.88 / 4.78
Cottons  +  Cupboard dry	-1.5	4.5	1400	50	01:42 / 01:29	2.73 / 2.68
Cottons  +  Cupboard dry	-1.5	9.0	1000	60	03:13 / 02:57	5.62 / 5.55
Cottons  +  Cupboard dry	-1.5	4.5	1000	60	01:56 / 01:42	3.15 / 3.10
Cottons  +  Cupboard dry	-1.5	9.0	800	70	03:37 / 03:20	6.36 / 6.32
Cottons  +  Cupboard dry	-1.5	4.5	800	70	02:10 / 01:56	3.56 / 3.53
Cottons eco 	0.0	9.0	1400	50	02:44 / 02:29	4.70 / 4.63
Cottons eco 	0.0	4.5	1400	50	01:34 / 01:24	2.59 / 2.57

¹ Consumption value for a minimum installation protection of 10 A/Consumption value for a minimum installation protection of 13 A

Programme		Final moisture level (%)	Load (kg)	Spin speed (rpm)	Initial moisture level (%)	Programme duration (h:min) ¹	Energy consumption (kWh/cycle) ¹
Cottons eco		0.0	9.0	1000	60	03:07 / 02:52	5.45 / 5.40
Cottons eco		0.0	4.5	1000	60	01:48 / 01:37	3.00 / 2.98
Cottons eco		0.0	9.0	800	70	03:31 / 03:15	6.21 / 6.17
Cottons eco		0.0	4.5	800	70	02:02 / 01:50	3.42 / 3.39
Cottons dry	 + 	12.0	9.0	1400	50	01:59 / 01:50	3.51 / 3.46
Cottons dry	 + 	12.0	4.5	1400	50	01:07 / 00:53	1.86 / 1.82
Cottons dry	 + 	12.0	9.0	1000	60	02:24 / 02:13	4.27 / 4.25
Cottons dry	 + 	12.0	4.5	1000	60	01:21 / 01:06	2.28 / 2.26
Cottons dry	 + 	12.0	9.0	800	70	02:48 / 02:36	5.02 / 5.03
Cottons dry	 + 	12.0	4.5	800	70	01:35 / 01:20	2.71 / 2.69
Easy-care board dry	 + 	2.0	3.5	800	40	00:52 / 00:44	1.45 / 1.42
Easy-care board dry	 + 	2.0	3.5	600	50	01:02 / 00:53	1.66 / 1.74

¹ Consumption value for a minimum installation protection of 10 A/Consumption value for a minimum installation protection of 13 A

20 Technical data

Appliance height	84.2 cm
Appliance width	59.8 cm
Appliance depth	61.3 cm

¹ Setting the higher value results in the appliance having a higher nominal power.

Appliance depth with door closed	64.8 cm
Appliance depth with door open	109.6 cm
Weight	42.3 kg

¹ Setting the higher value results in the appliance having a higher nominal power.

en Technical data

Maximum load	9.0 kg
Mains voltage	220-240 V, 50 Hz
⇒ Minimum installation protection	13/10 A ¹
Nominal power	2800/2100 W
Power consumption	■ Off mode: 0.15 W ■ Left-on mode: 0.50 W
Ambient temperature	■ Minimum: 5 °C ■ Maximum: 35 °C
Length of the power cord	145 cm

¹ Setting the higher value results in the appliance having a higher nominal power.

EN Manufactured by BSH Hausgeräte GmbH under the trademark licence of Siemens AG

BSH Hausgeräte GmbH
Carl-Wery-Straße 34
81739 München, GERMANY
siemens-home.bsh-group.com



9001620294

(040216)

en