

SIEMENS

Oven

CM878G4.6B

en User manual and installation instructions



Register your product on My Siemens and discover exclusive services and offers.
siemens-home.bsh-group.com/welcome

The future moving in.

Siemens Home Appliances

Table of contents

USER MANUAL

1	Safety	2
2	Preventing material damage	6
3	Environmental protection and saving energy	7
4	Familiarising yourself with your appliance	9
5	Operating modes	10
6	Accessories.....	12
7	Before using for the first time	13
8	Basic operation	14
9	Rapid heating	15
10	Time-setting options.....	15
11	Microwave	16
12	Meat probe.....	19
13	Dishes	20
14	Childproof lock.....	22
15	Sabbath mode	22
16	Home Connect	23
17	Basic settings.....	24
18	Cleaning and servicing.....	25
19	Self-cleaning.....	27
20	Cleaning assistance.....	28
21	Drying	29
22	Appliance door	29
23	Rails	31
24	Troubleshooting.....	32
25	Disposal.....	34
26	Customer Service.....	34
27	Declaration of Conformity	34
28	How it works.....	35
29	INSTALLATION INSTRUCTIONS	43
29.1	General installation instructions.....	43



1 Safety

Observe the following safety instructions.

1.1 General information

- Read this instruction manual carefully.
- Keep the instruction manual and the product information safe for future reference or for the next owner.
- Do not connect the appliance if it has been damaged in transit.

1.2 Intended use

This appliance is designed only to be built into kitchen units. Read the special installation instructions.

Only a licensed professional may connect appliances without plugs. Damage caused by incorrect connection is not covered under the warranty.

Only use this appliance:

- To prepare meals and drinks.
- For household use and similar applications, such as: In kitchens for employees in shops, offices and other commercial sectors; in agriculture; by customers in hotels and other residential facilities; in bed and breakfasts.
- Up to an altitude of max. 4000 m above sea level.

This appliance complies with the standards EN 55011 and CISPR 11. It is a group 2, class B product. Group 2 means that microwaves are produced for the purpose of heating food. Class B means that the appliance is suitable for private households.

1.3 Restriction on user group

This appliance may be used by children aged 8 or over and by people who have reduced physical, sensory or mental abilities or inadequate experience and/or knowledge, provided that they are supervised or have been instructed on how to use the appliance safely and have understood the resulting dangers.

Children must not play with the appliance. Children must not perform cleaning or user maintenance unless they are at least 15 years old and are being supervised.

Keep children under the age of 8 years away from the appliance and power cable.

1.4 Safe use

Always place accessories in the cooking compartment the right way round.

→ "Accessories", Page 12

⚠ WARNING – Risk of fire!

Combustible objects that are left in the cooking compartment may catch fire.

- ▶ Never store combustible objects in the cooking compartment.
- ▶ If smoke is emitted, the appliance must be switched off or the plug must be pulled out and the door must be held closed in order to stifle any flames.

Loose food remnants, fat and meat juices may catch fire.

- ▶ Before using the appliance, remove the worst of the food residues and remnants from the cooking compartment, heating elements and accessories.

Opening the appliance door creates a draught. Greaseproof paper may come into contact with the heating element and catch fire.

- ▶ Never place greaseproof paper loosely over accessories when preheating the appliance and while cooking.
- ▶ Always cut greaseproof paper to size and use a plate or baking tin to hold it down.

⚠ WARNING – Risk of burns!

The appliance and its parts that can be touched become hot during use.

- ▶ Caution should be exercised here in order to avoid touching heating elements.
- ▶ Young children under 8 years of age must be kept away from the appliance.

Accessories and cookware get very hot.

- ▶ Always use oven gloves to remove accessories or cookware from the cooking compartment.

When the cooking compartment is hot, any alcoholic vapours inside may catch fire.

- ▶ Only use small quantities of drinks with a high alcohol content in food.
- ▶ Open the appliance door carefully.

⚠ WARNING – Risk of scalding!

The accessible parts of the appliance become hot during operation.

- ▶ Never touch these hot parts.
- ▶ Keep children at a safe distance.

Hot steam may escape when you open the appliance door. Steam may not be visible, depending on the temperature.

- ▶ Open the appliance door carefully.
- ▶ Keep children at a safe distance.

If there is water in the cooking compartment when it is hot, this may create hot steam.

- ▶ Never pour water into the cooking compartment when the cooking compartment is hot.

⚠ WARNING – Risk of injury!

Scratched glass in the appliance door may develop into a crack.

- ▶ Do not use any harsh or abrasive cleaners or sharp metal scrapers to clean the glass on the oven door, as they may scratch the surface.

The hinges on the appliance door move when the door is opened and closed, which could trap your fingers.

- ▶ Keep your hands away from the hinges. Components inside the appliance door may have sharp edges.
- ▶ Wear protective gloves.

⚠ WARNING – Risk of electric shock!

Incorrect repairs are dangerous.

- ▶ Repairs to the appliance should only be carried out by trained specialist staff.
- ▶ Only use genuine spare parts when repairing the appliance.
- ▶ If the power cord of this appliance is damaged, it must be replaced by the manufacturer, the manufacturer's Customer Service or a similarly qualified person in order to prevent any risk.

If the insulation of the power cord is damaged, this is dangerous.

- ▶ Never let the power cord come into contact with hot appliance parts or heat sources.
- ▶ Never let the power cord come into contact with sharp points or edges.
- ▶ Never kink, crush or modify the power cord.

An ingress of moisture can cause an electric shock.

- ▶ Do not use steam- or high-pressure cleaners to clean the appliance.

If the appliance or the power cord is damaged, this is dangerous.

- ▶ Never operate a damaged appliance.
- ▶ Never operate an appliance with a cracked or fractured surface.
- ▶ Never pull on the power cord to unplug the appliance. Always unplug the appliance at the mains.
- ▶ If the appliance or the power cord is damaged, immediately unplug the power cord or switch off the fuse in the fuse box.
- ▶ Call customer services. → *Page 34*

⚠ WARNING – Danger: Magnetism!

Permanent magnets are used in the control panel or in the controls. These may affect electronic implants, e.g. heart pacemakers or insulin pumps.

- ▶ Wearers of electronic implants must stay at least 10 cm away from the control panel.

⚠ WARNING – Risk of suffocation!

Children may put packaging material over their heads or wrap themselves up in it and suffocate.

- ▶ Keep packaging material away from children.
- ▶ Do not let children play with packaging material.

Children may breathe in or swallow small parts, causing them to suffocate.

- ▶ Keep small parts away from children.
- ▶ Do not let children play with small parts.

1.5 Microwave

CAREFULLY READ THE IMPORTANT SAFETY INSTRUCTIONS AND KEEP THEM SAFE FOR FUTURE USE

⚠ WARNING – Risk of fire!

Using the appliance for anything other than its intended purpose is dangerous and may cause damage. For example, heated slippers and pillows filled with grain or cereal may catch fire, even several hours later.

- ▶ Never dry food or clothing with the appliance.
- ▶ Never heat up slippers, pillows filled with grain or cereal, sponges, damp cleaning cloths or similar with the appliance.
- ▶ The appliance must only be used to prepare food and drink.

Food and its packaging and containers may catch fire.

- ▶ Never heat food in heat-retaining packaging.
- ▶ Do not leave food unattended while it is heating in containers made of plastic, paper or other combustible materials.
- ▶ Never set the microwave power too high or the cooking time too long. Follow the instructions provided in this user manual.
- ▶ Never use the microwave to dry food.
- ▶ Never defrost or heat food with a low water content, such as bread, at too high a microwave power or for too long.

Cooking oil may catch fire.

- ▶ Never use the microwave to heat cooking oil on its own.

⚠ WARNING – Risk of explosion!

Liquids and other food may easily explode when in containers that have been tightly sealed.

- ▶ Never heat liquids or other food in containers that have been tightly sealed.

⚠ WARNING – Risk of burns!

Foods with peel or skin may burst or explode during heating, or even afterwards.

- ▶ Never cook eggs in their shell or heat hard-boiled eggs in their shell.
- ▶ Never cook shellfish or crustaceans.
- ▶ Always prick the yolk of eggs before microwaving.
- ▶ The skin of foods that have a peel or skin, such as apples, tomatoes, potatoes and sausages, may burst. Before heating, prick the peel or skin.

Heat is not distributed evenly through baby food.

- ▶ Never heat baby food in closed containers.
- ▶ Always remove the lid or teat.
- ▶ Stir or shake well after heating.
- ▶ Check the temperature before giving the food or drink to a child.

Heated food gives off heat. The cookware may become hot.

- ▶ Always use oven gloves to remove cookware or accessories from the cooking compartment.

Airtight packaging may burst when food is heated.

- ▶ Always follow the instructions on the packaging.
 - ▶ Always use oven gloves to remove the dishes from the cooking compartment.
- The accessible parts of the appliance become hot during operation.

- ▶ Never touch these hot parts.
- ▶ Keep children at a safe distance.

At the highest settings in microwave only mode, the drying function will automatically switch on an additional heating element to heat the cooking compartment.

- ▶ Never touch the inside surfaces of the cooking compartment or the heating elements while they are hot.
- ▶ Keep children at a safe distance.

Using the appliance for anything other than its intended purpose is dangerous. This is because, for instance, overheated slippers, pillows filled with grain or cereal, sponges and damp cleaning cloths, etc., may cause burns to the skin.

- ▶ Never dry food or clothing with the appliance.
- ▶ Never heat up slippers, pillows filled with grain or cereal, sponges, damp cleaning cloths or similar with the appliance.
- ▶ The appliance must only be used to prepare food and drink.

⚠ WARNING – Risk of scalding!

There is a possibility of delayed boiling when a liquid is heated. This means that the liquid reaches the boiling temperature without the usual steam bubbles rising to the surface. Exercise caution even when only gently shaking the container. The hot liquid may suddenly boil over and splatter.

- ▶ Always place a spoon in the container when heating liquids. This prevents delayed boiling.

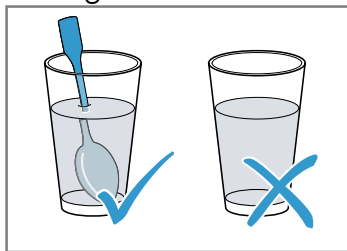

⚠ WARNING – Risk of injury!

Unsuitable cookware may crack. Porcelain or ceramic cookware can have small perforations in the handles and lid. These perforations conceal a cavity below. If moisture penetrates this cavity, it could cause the cookware to crack.

- ▶ Only use microwave-safe cookware. Cookware and containers made from metal or cookware with metal edging may lead to sparks being formed during simple microwave operation. The appliance is damaged.
- ▶ Never use metal containers during microwave-only operation.
- ▶ Only use microwave-safe cookware or use the microwave in combination with a type of heating.

⚠ WARNING – Risk of electric shock!

The appliance uses a high voltage.

- ▶ Never remove the casing.

⚠ WARNING – Risk of serious harm to health!

Inadequate cleaning may destroy the surface of the appliance, reduce its service life, and lead to dangerous situations, such as escaping microwave energy.

- ▶ Clean the appliance on a regular basis, and remove any food residue immediately.
- ▶ Always keep the cooking compartment, door seal, door and door stop clean.

→ "Cleaning and servicing", Page 25

Never operate the appliance if the cooking compartment door or the door seal is damaged. Microwave energy may escape.

- ▶ Never use the appliance if the cooking compartment door, the door seal or the plastic door frame is damaged.
- ▶ Any repair work must only be carried out by the after-sales service.

Microwave energy will escape from appliances that do not have any casing.

- ▶ Never remove the casing.
- ▶ Contact our after-sales service if maintenance or repair work is needed.

1.6 Meat probe

⚠ WARNING – Risk of electric shock!

Using the wrong meat probe could damage the insulation.

- ▶ Only use the meat probe for this specific appliance.

1.7 Cleaning function

⚠ WARNING – Risk of fire!

Loose food remnants, fat and meat juices may catch fire when the cleaning function is in progress.

- ▶ Before you start the cleaning function, always remove coarse dirt from the cooking compartment.
- ▶ Never clean accessories at the same time. The outside of the appliance gets very hot when the cleaning function is in progress.
- ▶ Never hang combustible objects, e.g. tea towels, on the door handle.
- ▶ Leave the front of the appliance clear.
- ▶ Keep children at a safe distance.

If the door seal is damaged, a large amount of heat is generated around the door.

- ▶ Do not scrub or remove the seal.
- ▶ Never operate the appliance if the seal is damaged or missing.

⚠ WARNING – Risk of serious harm to health!

The appliance gets very hot when the cleaning function is in progress. The non-stick coating on baking trays and tins is destroyed and noxious gases are released.

- ▶ Never clean non-stick baking trays or baking tins using the cleaning function.
- ▶ Never clean accessories at the same time.

⚠ WARNING – Risk of harm to health!

The cleaning function heats up the cooking compartment to a very high temperature so that food left over from roasting, grilling and baking will burn off. This process releases vapours, which can irritate mucous membranes.

- ▶ Keep the kitchen well ventilated while the cleaning function is running.
- ▶ Do not remain in the room for long periods.
- ▶ Keep children and pets away.

⚠ WARNING – Risk of burns!

The cooking compartment gets very hot when the cleaning function is in progress.

- ▶ Never open the appliance door.
- ▶ Allow the appliance to cool down.
- ▶ Keep children at a safe distance.

⚠ The outside of the appliance gets very hot when the cleaning function is in progress.

- ▶ Never touch the appliance door.
- ▶ Allow the appliance to cool down.
- ▶ Keep children at a safe distance.

2 Preventing material damage

2.1 General

ATTENTION!

Objects on the cooking compartment floor at over 50 °C will cause heat to build up. The baking and roasting times will no longer be correct and the enamel will be damaged.

- ▶ Do not place any accessories, greaseproof paper or foil of any kind on the cooking compartment floor.
- ▶ Only place cookware on the cooking compartment floor if a temperature above 50 °C has been set.

Using silicone moulds or any film, covers or accessories that contain silicone could damage the baking sensor. Damage may occur even if the baking sensor is not active.

- ▶ Do not use silicone moulds or any film, covers or accessories that contain silicone.
- ▶ Never place objects made of silicone in the cooking compartment.

When the cooking compartment is hot, any water inside it will create steam. The change in temperature may cause damage.

- ▶ Never pour water into the cooking compartment when it is still hot.
- ▶ Never place cookware containing water on the cooking compartment floor.

The prolonged presence of moisture in the cooking compartment leads to corrosion.

- ▶ Allow the cooking compartment to dry after use.
- ▶ Do not keep moist food in the cooking compartment for a long time with the door closed.
- ▶ Do not store food in the cooking compartment.

Leaving the appliance to cool down with the door open will damage the front of neighbouring kitchen units over time.

- ▶ Always allow the cooking compartment to cool down with the door closed after cooking at high temperatures.
- ▶ Take care not to trap anything in the appliance door.
- ▶ Only leave the cooking compartment to dry with the door open if a lot of moisture was produced during operation.

Fruit juice dripping from the baking tray leaves stains that cannot be removed.

- ▶ When baking very juicy fruit flans, do not pack too much on the baking tray.
- ▶ If possible, use the deeper universal pan.

Using oven cleaner in a hot cooking compartment damages the enamel.

- ▶ Never use oven cleaner in the cooking compartment when it is still warm.
- ▶ Remove all food remnants from the cooking compartment and the appliance door before you next heat up the appliance.

If the seal is very dirty, the appliance door will no longer close properly during operation. This may damage the front of adjacent kitchen units.

- ▶ Keep the seal clean at all times.
- ▶ Never operate the appliance if the seal is damaged or missing.

Sitting or placing objects on the appliance door may damage it.

- ▶ Do not place or hang objects on the appliance door.
- ▶ Do not place cookware or accessories on the appliance door.

With certain models, accessories may scratch the door pane when closing the appliance door.

- ▶ Always push accessories fully into the cooking compartment.

2.2 Microwave

Follow these instructions when using the microwave.

ATTENTION!

Metal touching the wall of the cooking compartment will cause sparks, which may damage the appliance or the inner door pane.

- ▶ Metal (e.g. a spoon in a glass) must be kept at least 2 cm from the cooking compartment walls and the inside of the door.

Using accessories directly on top of one another causes sparks.

- ▶ Do not combine the wire rack with the universal pan.

- ▶ Always place accessories on different levels.

The universal pan and baking tray are not suitable for use with microwave-only mode. Using either of these may create sparks, which will damage the cooking compartment.

- ▶ Place accessories on the wire rack supplied.

Placing aluminium containers in the appliance may cause sparks, which will damage the appliance.

- ▶ Do not use aluminium containers in the appliance.

Operating the appliance without food in the cooking compartment may lead to overloading.

- ▶ Do not switch on the microwave unless there is food inside. The only exception to this rule is when performing a short cookware test.

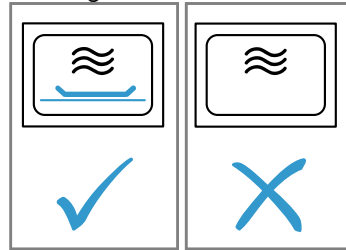

If you prepare microwave popcorn at a microwave power level that is too high, the door pane may crack due to overloading.

- ▶ Never set a microwave power level that is too high.
- ▶ Use a maximum microwave output of 600 watts.
- ▶ Always place the popcorn bag on a glass plate.

3 Environmental protection and saving energy

3.1 Disposing of packaging

The packaging materials are environmentally compatible and can be recycled.

- ▶ Sort the individual components by type and dispose of them separately.

3.2 Saving energy

If you follow these instructions, your appliance will use less power.

Only preheat the appliance if the recipe or the recommended settings tell you to do so.

- Not preheating the appliance can reduce the energy used by up to 20%.

Use dark-coloured, black-coated or enamelled baking tins.

- These types of baking tin absorb the heat particularly well.

Open the appliance door as little as possible during operation.

- This will maintain the temperature in the cooking compartment and eliminate the need for the appliance to reheat.

When baking multiple dishes, do so in succession or in parallel.

- The cooking compartment is heated after baking the first dish. This reduces the baking time for the second cake.

en Environmental protection and saving energy

If the cooking time is relatively long, you can switch the appliance off 10 minutes before the cooking time ends.

- There will be enough residual heat to finish cooking the dish.

Remove any accessories that are not being used from the cooking compartment.

- Accessories that are not being used do not need to be heated.

Allow frozen food to defrost before cooking.

- This will save the energy that would otherwise be required to defrost it.

4 Familiarising yourself with your appliance

4.1 Control panel

You can use the control panel to configure all functions of your appliance and to obtain information about the operating status.

Note: On certain models, specific details such as colour and shape may differ from those pictured.

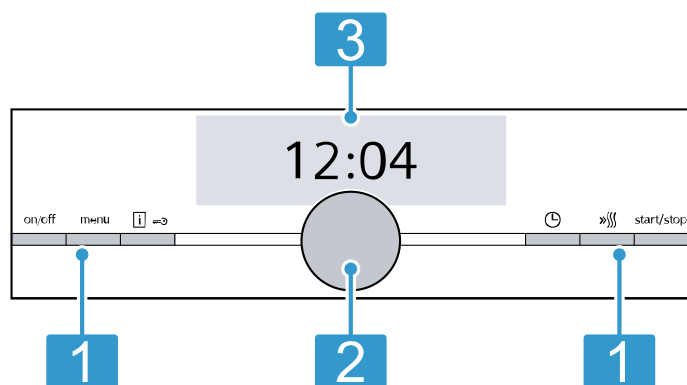

1 Buttons

The buttons on the left- and right-hand side of the control panel have a pressure point. Press a button to execute its function. On appliances without a stainless steel front, the buttons are also touch fields.

2 Rotary selector

You can turn the rotary selector without limits clockwise or anti-clockwise. Touch fields are touch-sensitive surfaces. To select a function, simply press lightly on the relevant field.

3 Touch display

You can see the current selection options in the touch displays. To select a function, press directly on the corresponding field. The text fields change depending on the selection.

4.2 Buttons

Use the buttons on the left- and right-hand side of the control panel to switch your device or the operating mode on and off.

Button	Function	Use
on/off	On/off	Switch the appliance on or off.
menu	Menu	Open the operating mode menu
i ↻	Information	Display notifications Activate and deactivate the childproof lock
i ↻	Childproof lock	Activate and deactivate the childproof lock
L	Time-setting options	Press briefly: Start or pause operation. Press and hold for approx. three seconds: Cancel operation.
»»»	Rapid heat-up	Switch rapid heat-up on and off
start/stop	Start/stop	Start, pause or cancel the operation

4.3 Rotary selector

Use the rotary selector to change the setting values that are shown in the display.

If you have reached the minimum or maximum value for setting values, e.g. the temperature, this value remains in the display. If required, use the rotary selector to turn the value back again.

For lists, e.g. the types of heating, the first value starts again after the last value.

4.4 Display

The display shows the current setting values.

The value that you can change in the display is highlighted in colour.

Status bar

The status bar is at the top of the display.

The time and set time functions are shown in the status bar.

Progress line

The line is shown in the display below the highlighted value.

The progress line shows you how much the appliance has already heated up or how much time has elapsed. The line is filled from left to right.

The heating line does not appear when using the microwave.

Countdown

You can view the countdown time or the cooking time for the previous operation in the top right in the status bar.

If you have set a cooking time and the cooking time is deleted, the countdown time takes over from the time that has already elapsed from the cooking time. You can therefore always check how long the operation has already been running.

The heating line does not appear when using the microwave.

Temperature display

The heating-up control and the residual heat indicator show you the temperature in the cooking compartment. Due to thermal inertia, the temperature that is displayed may differ slightly from the actual temperature inside the cooking compartment. You can use the  button to check the current temperature.

- Heating-up control

After the operation starts, the heating-up indicator displays the rising temperature in the cooking compartment. When you are preheating the appliance, the optimal time to place your food in the cooking compartment is as soon as all the bars are filled. For set levels, e.g. for grill settings, the heating-up indicator is not displayed.

- Residual heat indicator

When the appliance is switched off, the display shows the residual heat in the cooking compartment. The residual heat indicator goes out at approx. 60 °C.

4.5 Cooking compartment

The functions in the cooking compartment make your appliance easier to use.

Shelf supports

The rails in the cooking compartment enable you to place accessories at different heights.

→ "Accessories", Page 12

Your appliance has three shelf positions. The shelf positions are numbered from bottom to top.

The rails are equipped with pull-out rails on one or more levels, depending on the appliance type.

You can remove the rails, e.g. for cleaning.
→ "Rails", Page 31

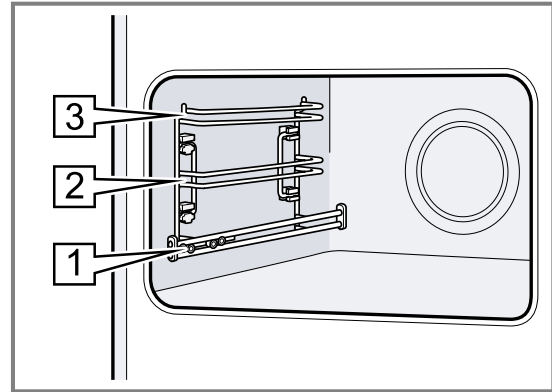

Lighting

One or more oven lights illuminate the cooking compartment.

When you open the appliance door, the light in the cooking compartment switches on. If the appliance door remains open for longer than 15 minutes, the light switches off again.

For most operating modes, the lighting is switched on during operation. The lighting switches off again when the operation ends.

Cooling fan

The cooling fan switches on and off depending on the appliance's temperature. The hot air escapes above the door.

ATTENTION!

Do not cover the ventilation slot above the appliance door. The appliance overheats.

- ▶ Ensure that the ventilation slots are unobstructed.

To ensure that the appliance cools down more quickly after operation, the cooling fan continues to run for a certain period afterwards.

Appliance door

If you open the appliance door during operation, the operation stops. When you close the appliance door, the operation continues automatically.

In microwave mode, when you close the appliance door, you have to press **start/stop** to continue.

5 Operating modes

This is where you can find an overview of your appliance's operating modes and main functions.

Press menu to open the menu.

Operating mode	Use
Types of heating	Select finely tuned types of heating for the optimal preparation of your food.
Meals	Use programmed, recommended settings for various meals. → "Dishes", Page 20
Microwave	Cook, heat or defrost quicker with the microwave. → "Microwave", Page 16

Operating mode	Use
Microwave combination	To reduce the cooking time, switch on the microwave for a type of heating. → "Microwave combination", Page 18
Self-cleaning	The self-cleaning function cleans your oven automatically. → "Self-cleaning", Page 27
Basic settings	Adjust the basic settings. Basic settings → Page 24
Home Connect	Connect the oven to a mobile end device and remotely control it. → "Home Connect", Page 23















5.1 Types of heating

To ensure that you always use the right type of heating to cook your food, we explain the differences and applications below.

The symbols for each type of heating help you to remember them.

When you select a type of heating, the appliance suggests a suitable temperature or setting. You can use these values or change them within the specified range.

For temperature settings above 275 °C and grill setting 3, the appliance reduces the temperature to approx. 275 °C or grill setting 1 after approx. 40 minutes.

Symbol	Types of heating	Temperature range	What it's used for and how it works Possible additional options
	4D hot air	30–275 °C	Bake and roast on one or more levels. The fan distributes the heat from the ring-shaped heating element in the back wall evenly around the cooking compartment.
	Top/bottom heating	30–300 °C	Traditionally bake or roast on one level. This type of heating is ideal for cakes with moist toppings. The heat is emitted evenly from above and below.
	Hot air eco	30–275 °C	Cook selected dishes gently on one level without preheating. The fan distributes the heat from the ring-shaped heating element in the back wall evenly around the cooking compartment. The food is cooked in phases using residual heat. This type of heating is most effective between 125 and 275 °C. Always keep the appliance door closed when cooking. This type of heating is used to determine the energy consumption in air recirculation mode and the energy efficiency class.
	Top/bottom heating eco	30–300 °C	Gently cook selected dishes. Heat is emitted from above and below. This heating function is most effective between 150 and 250 °C. This type of heating is used to measure the energy consumption in the conventional mode.
	Circulated air grilling	30–300 °C	Roast poultry, whole fish or larger pieces of meat. The grill element and the fan switch on and off alternately. The fan circulates the hot air around the food.
	Grill, large area	Grill settings: 1 = low 2 = medium 3 = high	Grill flat items such as steak and sausages, or make toast. Gratinated food. The entire area below the grill element becomes hot.
	Grill, small area	Grill settings: 1 = low 2 = medium 3 = high	Grill small quantities, such as steak, sausages or toast. Gratinated small quantities of food. The central area below the grill element becomes hot.
	Pizza setting	30–275 °C	Cook pizza or dishes that require a lot of heat from below. The bottom heating element and the ring-shaped heating element in the back wall heat the cooking compartment.
	Intensive heat	30–300 °C	Prepare dishes with a crispy base. The heat is emitted from above and more intensively from below.
	Slow cooking	70–120 °C	Slowly and gently cook seared, tender pieces of meat in uncovered cookware. The heat is emitted evenly from above and below at a low temperature.
	Bottom heating	30–250 °C	Final baking or cooking food in a bain marie. Heat is emitted from below.
	Drying	30–150 °C	Dry herbs, fruit or vegetables.
	Keeping food warm	60–100 °C	Keep cooked food warm.
	Plate warming	30–70 °C	Plate warming.
	CoolStart function	30–275 °C	For quickly preparing frozen products at position 1. The temperature depends on the manufacturer's instructions. Use the highest temperature specified on the packaging. The cooking time is as specified, or shorter. Preheating is not useful.

5.2 Microwave power settings

This is where you can find an overview of the different microwave power settings and when to use them. The microwave power settings are levels and do not always correspond to the exact wattage that the appliance uses.

Microwave power in watts	Maximum cooking time in hours	Use
90 W	1:30	Defrost delicate foods.
180 W	1:30	Defrost food and continue cooking.
360 W	1:30	Cook fish and meat. Heat up delicate foods.
600 W	1:30	Heat and cook food.
Max.	0:30	Heat liquids.

Notes

- The maximum microwave power setting is not designed for heating food. To protect the appliance, the maximum power of the microwave is gradually reduced to 600 watts during the first few minutes. Full power is made available again after a cooling period.

- To prevent condensation, the appliance automatically switches on a heating element at the maximum microwave output of 600 watts and max. The cooking compartment and the accessories become hot. The cooking result is not affected by this.

6 Accessories

Use original accessories. These have been made especially for your appliance.

Note: Accessories may become deformed if they get hot. Deformation has no effect on function. As the accessory cools down, it will regain its original shape.

The accessories supplied may differ depending on the appliance model.

Accessories

Wire rack

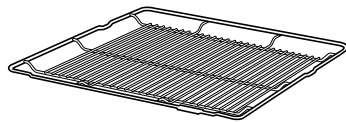

Universal pan

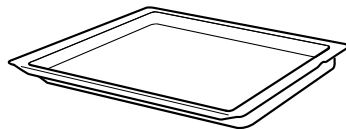

Use

- Cake tins
 - Ovenproof dishes
 - Cookware
 - Meat, e.g. roasting joints or steak
 - Frozen meals
-
- Moist cakes
 - Baked items
 - Bread
 - Large roasts
 - Frozen meals
 - Catch dripping liquids, e.g. fat when grilling food on the wire rack.

6.1 Information on accessories

Some accessories are only suitable for certain types of heating.

Microwave accessories

The wire rack that is supplied is only suitable for operation solely using the microwave.

Baking trays, e.g. the universal pan or the baking tray, may create sparks and are not suitable.

Observe the information about the microwave.

→ "Cookware and accessories with microwave",

Page 16

6.2 Locking function

The locking function prevents the accessories from tilting when they are pulled out.

You can pull out the accessories approximately halfway without them tipping. The accessories must be inserted into the cooking compartment correctly for the tilt protection to work properly.

6.3 Sliding accessories into the cooking compartment

Always slide the accessory into the cooking compartment the right way round. This is the only way to ensure that accessories can be pulled out approximately halfway without tipping.

1. Turn the accessories so that the notch  is at the rear and is facing downwards.

2. Insert the accessory between the two guide rods for a shelf position.

Wire rack Push the wire rack in with the curvature  pointing downwards. The word "microwave" must be at the front at the appliance door.

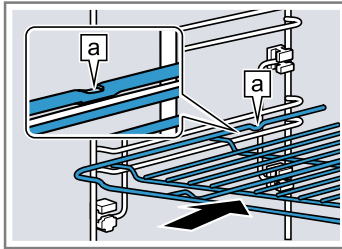

Baking tray Slide the tray in with the sloping edge  towards the appliance door.
E.g. universal pan or baking tray

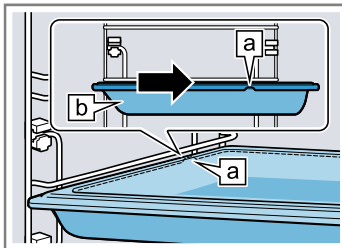

3. To place the accessory at shelf positions with pull-out rails, pull out the pull-out rails.

Wire rack or baking tray

Position the accessory so that its edge is behind the lug  on the pull-out rail.

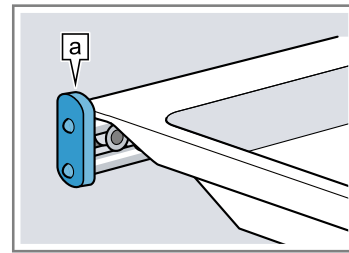

Note: The pull-out rails lock in place when they are fully pulled out. Gently push the pull-out rails back into the cooking compartment.

4. Push the accessory all the way in, making sure that it does not touch the appliance door.

Note: Take any accessories that you will not be using out of the cooking compartment while the appliance is in operation.

6.4 Other accessories

You can purchase other accessories from our after-sales service, specialist retailers or online. You will find a comprehensive range of products for your appliance in our brochures and online: www.siemens-home.bsh-group.com Accessories vary from one appliance to another. When purchasing accessories, always quote the exact product number (E no.) of your appliance. You can find out which accessories are available for your appliance in our online shop or from our after-sales service.

7 Before using for the first time

Configure the settings for initial start-up. Clean the appliance and accessories.

7.1 Carrying out the initial configuration

When the appliance is connected to the electricity supply for the first time or following a lengthy power cut, you must configure the settings before you can use it. It may take a few seconds for the settings to appear on the display.

Note: You can also enter the settings using the Home Connect assistant. In this case, press  to go to the last point in the initial configuration. If your appliance is connected, follow the instructions in the app.



Setting the language

1. Use the rotary selector to select the required language.
 2. Press .
- ✓ The next setting appears.

Setting the time

1. Turn the rotary selector to set the current time.
 2. Press .
- ✓ The next setting appears.

Setting the date

1. Use the rotary selector to set the current day.
 2. Press .
 3. Use the rotary selector to set the current month.
 4. Press .
 5. Use the rotary selector to set the current year.
 6. Press .
- ✓ The next setting appears.

7.2 Cleaning the appliance before using it for the first time

Before using the appliance to cook food for the first time, you must clean the cooking compartment and accessories.

1. Remove the product information and the accessories from the cooking compartment. Remove any leftover packaging, such as polystyrene pellets, and any adhesive tape either in or on the appliance.
2. Wipe the smooth surfaces in the cooking compartment with a soft, damp cloth.
3. Press on/off to switch the appliance on.
4. Apply the following settings:

Type of heating

4D hot air 

Temperature	Maximum
Cooking time	1 hour

→ "Basic operation", Page 14

5. Press start/stop to start the operation.
 - Ventilate the kitchen while the appliance is heating.

6. When the cooking time has elapsed, press on/off to switch the appliance off.
7. Once the appliance has cooled down, clean the smooth surfaces in the cooking compartment with a detergent solution and a dish cloth.
8. Clean the accessories thoroughly using a detergent solution and a dish cloth or soft brush.

8 Basic operation

8.1 Switching on the appliance

- ▶ Press on/off to switch the appliance on.
 - The on/off button lights up blue.
- ✓ The Siemens logo appears in the display. A type of heating and a temperature are then displayed.

8.2 Switching off the appliance

Switch your appliance off when you are not using it. The appliance will switch itself off automatically if it is not used for a certain period of time.

- ▶ Press on/off to switch the appliance off.
 - The light above the on/off button goes out.
- ✓ The appliance switches off. Any functions currently in progress are cancelled.
- ✓ The time or residual heat indicator appears in the display.

8.3 Starting operation

You must start each cooking operation.

ATTENTION!

If there is water on the cooking compartment floor when operating the appliance at temperatures above 120 °C, this will damage the enamel.

- ▶ Do not use the appliance if there is water on the cooking compartment floor.
- ▶ Wipe away any water on the cooking compartment floor before operation.
- ▶ Press start/stop to start the operation.
- ✓ The settings, the run time and the heat-up line appear on the display.

8.4 Pausing or cancelling operation

You can briefly pause the operation and then continue. If you cancel the operation completely, the settings are reset.

1. To pause the operation briefly:
 - Briefly press start/stop.
 - To continue the operation, press start/stop.
2. To cancel the operation, press on/off.
- ✓ The operation stops and all of the settings are reset.

8.5 Setting an operating mode

Requirement: The appliance must be switched on.

1. Press menu.
 - The operating modes menu opens.
2. Press the operating mode that you require.
 - Various options are available depending on the operating mode.

3. The selection can be changed using the rotary selector.
 - Change any further settings depending on the selection.
4. Press start/stop to start.

8.6 Setting the type of heating and the temperature

When you switch on the appliance, the types of heating operating mode is set automatically.

1. Turn the rotary selector to select the required type of heating.
2. Press the temperature.
3. Use the rotary selector to set the temperature.
4. Press start/stop to start the operation.
 - ✓ The appliance starts heating.
 - ✓ The set type of heating, temperature and cooking time/appliance run time are shown in the display.
5. When the food is ready, press on/off to switch the appliance off.

Tip: The most suitable type of heating for your food can be found in the type of heating description.

Note: You can also set a cooking time and an operation end time on the appliance.

→ "Time-setting options", Page 15

Changing the type of heating

When you change the type of heating, the other settings are also reset.

1. Press start/stop to pause operation.
2. Press the type of heating.
3. Turn the rotary selector to select the required type of heating.
 - ✓ The corresponding recommended temperature appears on the display.

Changing the temperature

Once the operation has started, you can change the temperature directly.

- ▶ Use the rotary selector to change the temperature.
- ✓ The temperature is applied immediately.

8.7 Displaying information



In most cases, you can call up information about the function that you have just started. The appliance automatically displays certain information, e.g. to ask you to do/confirm something or to issue a warning.

- ▶ Press .
- ✓ When available, information is displayed for a few seconds.

9 Rapid heating

To save time, you can shorten the preheating time for set temperatures of 100 °C and higher.



You can use rapid heating for this type of heating:

- 4D hot air 
- Top/bottom heating 
- Intensive heat 

9.1 Setting rapid heating

To ensure an even cooking result, do not place the food in the cooking compartment until rapid heating has come to an end.

Note: Do not set a cooking time until rapid heating has come to an end.

1. Set a suitable type of heating and a temperature of at least 100 °C.
2. Press .
 - ✓ The  symbol appears on the left of the display next to the temperature.
 - ✓ The progress line begins to fill up.
3. When rapid heating has come to an end, a signal tone sounds. The  symbol disappears from the display.
4. Place the food in the cooking compartment.

Cancelling rapid heating



- ▶ Press .
- ✓ The  symbol disappears from the display.

10 Time-setting options

Your appliance has different time-setting options, with which you can control its operation.



10.1 Overview of the time-setting options

You can set a cooking time and an operation end time on the appliance. The timer runs independently of the appliance during the operation.

Time-setting option	Use
Timer 	You can set the timer to run independently of the appliance during operation. It does not affect the appliance.
Cooking time 	If you set a cooking time, the appliance will stop heating automatically once this time has elapsed.
End time 	Along with the cooking time (duration), you can set the time at which you want cooking to end. The appliance starts up automatically so that it finishes cooking at the required time.

10.2 Setting the timer



The timer runs independently during the operation. The timer can be set when the appliance is switched on or off, up to 24 hours. The timer has its own audible signal so that you can tell whether it is the timer or a cooking time that has elapsed.

1. Press .
 - ✓ The field for the timer opens.
2. Use the rotary selector to set the timer duration.
 - ✓ The timer starts automatically after a few seconds.
 - ✓ The  symbol and the time counting down are displayed on the left in the status bar.
 - ✓ The timer counts down.
 - ✓ When the timer duration has elapsed, a note appears on the display and an audible signal sounds.
3. Once the timer duration has elapsed:
 - Press  to silence the audible signal manually.

- To set another timer, press  and use the rotary selector to set the duration.



Changing the timer

You can change the timer duration at any time.

1. Press .
2. Use the rotary selector to change the timer duration.
3. Press  to confirm.

Cancelling the timer

You can cancel the timer duration at any time.

1. Press .
2. Use the rotary selector to reset the timer duration to zero.
3. Press  to confirm.



10.3 Setting the cooking time

You can set a cooking time for operation of up to 23 hours 59 minutes.

Requirement: The type of heating and a temperature or setting have been set.

1. Press .
- ✓ The time-setting options menu opens.
2. Use the rotary selector to set the cooking time.

Rotation direction	Default value
Left	10 minutes
Right	30 minutes

- The cooking time can be set in one-minute increments up to one hour, and then in five-minute increments. The end time is calculated automatically.
3. Press **start/stop** to start the operation.
 - ✓ The appliance starts to heat and the time starts to count down.
 - ✓ Once the cooking time has elapsed, an audible signal sounds. "Finished" appears in the status bar.
 4. Once the cooking time has elapsed:
 - Press  to silence the audible signal manually.
 - To set another cooking time, press  and use the rotary selector to set the cooking time.

- To continue without setting a cooking time, press start/stop.
- When the food is ready, press on/off to switch the appliance off.

Changing the cooking time

You can change the cooking time at any time.

1. Press \ominus .
2. Use the rotary selector to change the cooking time.
3. Then press start/stop twice.

Cancelling the cooking time

You can cancel the cooking operation time at any time.

1. Press \ominus .
2. Use the rotary selector to reset the cooking time to zero.
3. - To continue without setting a cooking time, press start/stop.

The type of heating and temperature settings are shown in the display.

10.4 Setting the end time

You can delay the time at which cooking is due to finish by up to 23 hours and 59 minutes.

Notes

- In order to achieve good cooking results, do not delay the end time once the appliance is operating.
- Food will spoil if you leave it in the cooking compartment for too long.

Requirements

- The type of heating and a temperature or setting have been set.
- A cooking time is set.

1. Press \ominus .
2. Press \rightarrow .

3. To set a later end time, turn the rotary selector.
4. Press start/stop to start the operation.
 - ✓ The status bar shows a notification when the operation starts. The appliance is in standby mode.
 - ✓ Once the start time has been reached, the appliance starts heating and the cooking time starts counting down in the status bar.
 - ✓ Once the cooking time has elapsed, an audible signal sounds. A notification appears in the status bar.
5. Once the cooking time has elapsed:
 - Press \ominus to silence the audible signal manually.
 - To set another cooking time, press \ominus and use the rotary selector to set the cooking time.
 - To continue without setting a cooking time, press start/stop.
 - When the food is ready, press on/off to switch the appliance off.

Cancelling the end time

The set end time can only be changed when the oven is in standby mode.

1. Press \ominus .
 - ✓ The time-setting options menu opens.
2. Press \rightarrow .
3. Use the rotary selector to reset the end time to zero.
 - ✓ The appliance starts to heat and the time starts to count down.

Changing the end time

The set end time can only be changed when the oven is in standby mode

1. Press \ominus .
 - ✓ The time-setting options menu opens.
2. Press " \rightarrow end".
3. Turn the rotary selector to change the end time.
4. Press start/stop to resume operation.

11 Microwave

You can use the microwave to cook, heat up, bake or defrost food very quickly. The microwave can be used on its own or in combination with a type of heating.

11.1 Cookware and accessories with microwave

To heat food evenly and avoid damaging your appliance, it is important to only use the right cookware and accessories.

Follow the cookware manufacturer's instructions. Unless otherwise specified, place the cookware and accessory on level 1.

Microwave-safe

Cookware and accessories	Information
Cookware made from heat-resistant, microwave-safe material: <ul style="list-style-type: none"> ■ Glass ■ Glass ceramic ■ Porcelain ■ Temperature-resistant plastic ■ Fully glazed ceramic without cracks 	These materials allow microwaves to pass through and are not damaged.

Cookware and accessories	Information
Serving dishes	You do not need to transfer your food. Note: Only use cookware with decorative gold or silver trim if the manufacturer guarantees its suitability for microwave use.
Supplied wire rack	Only the wire rack that is supplied is suitable for operation solely using the microwave. Note: Baking trays, e.g. the universal pan or the baking tray, may create sparks and are not suitable.

Not microwave-safe

Note: Observe the specifications for preventing material damage.

→ "Microwave", Page 7

Cookware and accessories	Information
Metal cookware and bakeware	Microwaves cannot pass through metal. The food is barely heated or not heated at all. Note: Metal may create sparks in pure microwave operation.

Cookware and accessories with MicroCombi

By combining the microwave and a type of heating, metal cookware and accessories are also possible.

Cookware and accessories	Information
Metal cookware and bakeware	Metal can be used with MicroCombi. Note: Metal must be kept at least 2 cm from the cooking compartment walls and the inside of the door.
Accessories supplied: ■ Wire rack ■ Universal pan	The supplied accessory is suitable for MicroCombi. No sparks are created.

Testing cookware for microwave suitability

If you are unsure whether your cookware is suitable for use in the microwave, carry out a cookware test.

ATTENTION!

Operating the appliance without food in the cooking compartment may lead to overloading.

- ▶ Do not switch on the microwave unless there is food inside. The only exception to this rule is when performing a short cookware test.

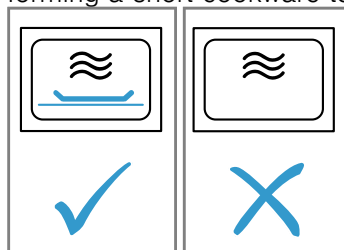

⚠ WARNING – Risk of burns!

The accessible parts of the appliance become hot during operation.

- ▶ Never touch these hot parts.
- ▶ Keep children at a safe distance.

1. Place the empty cookware in the cooking compartment.
2. Set the appliance to run for 30 seconds to 1 minute at maximum power.
3. Start the operation.
4. Check the cookware several times:
 - If the cookware remains cold or warm to the touch, it is suitable for microwave use.
 - If the cookware becomes hot or sparks are created, stop the cookware test. The cookware is not microwave-safe.

11.2 Configuring the microwave settings

Notes

- Note the correct way to operate the microwave:
 - → "Safety", Page 2
 - → "Preventing material damage", Page 6
 - → "Cookware and accessories with microwave", Page 16
- To prevent condensation, when the microwave output is 600 watts (max), the appliance automatically switches on a heating element. The cooking compartment and the accessories become hot. The cooking result is not affected by this. You can switch off this drying function in the basic settings.
→ "Basic settings", Page 24

⚠ WARNING – Risk of burns!

At the highest settings in microwave only mode, the drying function will automatically switch on an additional heating element to heat the cooking compartment.

- ▶ Never touch the inside surfaces of the cooking compartment or the heating elements while they are hot.
- ▶ Keep children at a safe distance.

1. Press menu.
2. Select the "Microwave" in the operating modes menu.
3. Press the required microwave output setting.
4. Use the rotary selector to set the cooking time.
5. Press start/stop to start the operation.

- ✓ The microwave starts and the cooking time counts down.
- ✓ Once the cooking time has elapsed, an audible signal sounds. The time shown in the display is zero.
- 6. Once the cooking time has elapsed:
 - Press **start/stop** to silence the audible signal manually.
 - If necessary, set the microwave output setting and cooking time again.
 - When the food is ready, press **on/off** to switch the appliance off.
- 7. If you have switched off the drying function for the microwave in the basic settings, dry the cooking compartment.
→ "Drying", Page 29

Note: If you open the appliance door during operation, the operation stops. When you close the appliance door, you must press **start/stop** to continue. If you have changed the basic setting, make sure that the microwave does not resume operation without food inside.

→ "Basic settings", Page 24

Changing the microwave output setting

If you change the microwave output setting, the cooking time is reset.

1. Press **start/stop** to pause operation.
The current microwave output is colour coded.
2. Press the required microwave output setting.
3. Press **start/stop** to resume operation.

Changing the cooking time

After the microwave starts operating, you can change the cooking time directly.

- ▶ Use the rotary selector to change the cooking time.
- ✓ The change is applied immediately.





11.3 Microwave combination

To reduce the cooking time, you can use certain types of heating in combination with microwave mode.

The possible microwave output settings are:

- 90 watts
- 180 watts
- 360 watts

The possible types of heating are:

- 4D hot air 
- Top/bottom heating 
- Circulated air grilling 
- Grill, large area 
- Grill, small area 

Setting the microwave combination

Note:

Note the correct way to operate the microwave:

- → "Safety", Page 2

- → "Preventing material damage", Page 6
-
- → "Cookware and accessories with microwave", Page 16
- 1. Press menu.
- 2. Select "Microwave combination" in the operating modes menu.
- ✓ "Type of heating", "Temperature", "Microwave output setting" and "Cooking time" recommendations are displayed.
- 3. Press the required function.
- 4. Set the desired value with the rotary selector.
- 5. Press **start/stop** to start the operation.
- ✓ The appliance starts to heat and the time starts to count down.
- ✓ Once the cooking time has elapsed, an audible signal sounds. A notification appears in the status bar.
- 6. Once the cooking time has elapsed:
 - Press **start/stop** to silence the audible signal manually.
 - If necessary, set another combination.
 - When the food is ready, press **on/off** to switch the appliance off.

Changing the temperature

Once the MicroCombi operation has started, you can change the temperature directly.

1. Press the temperature.
2. Use the rotary selector to change the temperature.
- ✓ The change is applied immediately.

Changing the cooking time

Once the MicroCombi operation has started, you can change the cooking time at any time.

1. Press "Cooking time".
2. Use the rotary selector to change the cooking time.
- ✓ The change is applied immediately.

Changing the microwave output setting

Once the MicroCombi operation has started, you can change the microwave output setting directly.

1. Press the microwave output setting.
2. Use the rotary selector to adjust the microwave output setting.
- ✓ The change is applied immediately.

Changing the type of heating

If you change the type of heating, the temperature also changes and the cooking time is reset.

1. Press **start/stop** to pause operation.
2. Press the types of heating.
3. Use the rotary selector to change the type of heating.
4. Press **start/stop** to resume operation.







12 Meat probe

Cook with precision by inserting the meat probe into the food and setting a core temperature on the appliance. Once the set core temperature has been reached in the food, the appliance automatically stops heating.

12.1 Suitable types of heating with the meat probe

Only certain types of heating are suitable for use with the roasting sensor.

Once you have placed the roasting sensor in the cooking compartment, the following types of heating are available for you to select.

- 4D hot air 
- Top/bottom heating 
- Hot air eco 
- Top/bottom heating eco 
- Circulated air grilling 
- Pizza setting 
- Intensive heat 

12.2 Inserting the meat thermometer

Use the meat probe supplied or order a suitable meat probe from our after-sales service.

WARNING – Risk of electric shock!

Using the wrong meat probe could damage the insulation.

- ▶ Only use the meat probe for this specific appliance.

ATTENTION!

Otherwise the meat probe may be damaged.

- ▶ Do not trap the cable of the meat probe.
- ▶ Do not use cookware with a lid.
- ▶ To prevent the meat probe from being damaged by excessive heat, there must be a gap of a few centimetres between the grill element and the meat probe. The meat may expand during the cooking process.

If, during operation with the microwave, the tip of the meat probe is not fully inside the food, sparks will be created.

- ▶ Insert the meat probe fully into the food.

1. Insert the meat probe into the food.
The meat probe has three measuring points. Ensure that at least the middle measuring point is inserted in the food.

Thin pieces of meat	Insert the meat probe into the thickest part of the meat from the side.
---------------------	---

Thick pieces of meat

Insert the meat probe diagonally into the meat from above, pushing it in as far as possible.

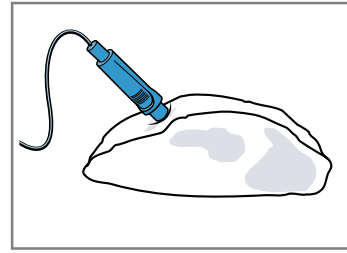

Poultry

Insert the meat probe into the thickest part of the breast, pushing it in as far as possible. The meat probe can be inserted horizontally or vertically depending on the size and shape of the poultry.

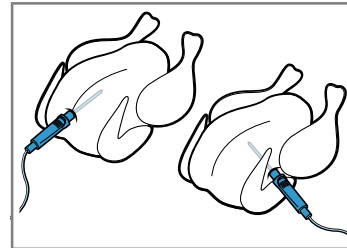

Turn the poultry and place it on the wire rack breast-side down.

2. Place the food with the meat probe into the cooking compartment.
3. Plug the meat probe into the socket on the left-hand side of the cooking compartment.

Notes

- If you remove the meat probe while the food is cooking, all the settings will be reset.
- Do not remove the meat probe when turning the food. Once you have turned the food, check that the meat probe is correctly positioned in the food.

12.3 Setting the meat thermometer

The roasting sensor measures the temperature inside the food between 30 °C and 99 °C.

Requirements

- The food with the roasting sensor is in the cooking compartment.
 - The roasting sensor is inserted in the cooking compartment.
1. In the operating modes menu, select "Types of heating", "Microwave combination" or "Dishes".
 2. Press the core temperature  in the various menus. In the "Dishes" operating modes menu, set the core temperature under "Adjust".
 3. Use the rotary selector to set the core temperature. Set the cooking compartment temperature at least 10 °C higher than the core temperature. Do not set the cooking compartment temperature to higher than 250 °C.
 4. Press start/stop to start the operation.
 - ✓ The appliance starts heating.
 - ✓ The time, the operation duration and the settings are shown in the display.

- ✓ The required temperature and core temperature are in the centre and to the right of the display. The current temperature or core temperature is shown on the progress line under the focused value. Press  to display the exact core temperature.
- ✓ Once the dish is ready, a signal sounds. The appliance stops heating. A notification appears on the display.

5. ⚠ WARNING – Risk of burns!

The cooking compartment, accessories and meat probe become very hot.

- ▶ Always use oven gloves to remove hot accessories and the meat probe from the cooking compartment.

When the core temperature is reached:

- Press on/off to switch the appliance off.
- Remove the roasting sensor from the socket in the cooking compartment.
- Remove the roasting sensor from the food and take it out of the cooking compartment.

Changing the temperature

Once the operation has started, you can change the temperature directly.

1. Use the rotary selector to change the temperature.
- ✓ The temperature is applied immediately.
2. To change the core temperature, press  and use the rotary selector to change the value.
- ✓ The core temperature is applied immediately.

Changing the temperature for dishes

Once the operation has started, you can change the temperature.

1. Press start/stop.
2. Press "Adjust".

3. Use the rotary selector to set the cooking compartment temperature.
 4. Press the core temperature .
 5. Use the rotary selector to adjust the core temperature.
 6. Press start/stop.
- ✓ The operation continues.

Changing the type of heating

When you change the type of heating, the other settings are also reset.

1. Press start/stop to pause operation.
 2. Press the type of heating.
 3. Turn the rotary selector to select the required type of heating.
- ✓ The corresponding recommended temperature appears on the display.

12.4 Core temperatures of different foods

Here you can find the suggested core temperatures of various different foods.

These suggestions depend on the quality and the size/shape of the food. Do not use frozen food.

Food	Core temperature in °C
Poultry	75
Pork	75
Beef, rare	50
Beef, medium	60
Beef, well done	70
Lamb	70
Heating food, reheating	65–75

13 Dishes

The "Dishes" operating mode helps you to use your appliance to prepare different meals by selecting the optimum settings automatically.

13.1 Cookware

The cooking result depends on the composition of the meat and the size of cookware.

You should therefore use heat-resistant cookware that is suitable for temperatures up to 300 °C. Glass or glass ceramic cookware is best. The joint should cover approx. two thirds of the cookware base.

Cookware made from the following material is not suitable:

- Bright, shiny aluminium
- Unglazed clay
- Plastic or plastic handles

Note: For some dishes, the appliance switches on the microwave. A notification appears in the display stating that you should use cookware that is suitable for microwave use.

→ "Cookware and accessories with microwave", Page 16

13.2 Settings for the dishes

To make the dishes perfectly, the appliance uses different settings.

Note: The cooking result depends on the quality and composition of the food. Use fresh and, ideally, chilled food. Use frozen food straight from the freezer.

Tips and information about the settings

If you set a dish, the display shows relevant information for this dish, e.g.:

- Suitable shelf position
- Suitable accessory or cookware
- Added liquid
- Time for turning or stirring

When this time is reached, a signal sounds.

To call up the information, press "Tip" or . Some notes are displayed automatically.

Programmes

The ideal type of heating, temperature and cooking time are preset for programmes.

In order to obtain an optimal cooking result, you must also set the weight. Unless otherwise indicated, set the total weight for your dish. You can set the weight only in the intended range.

Recommended settings

For the recommended settings, the optimum type of heating is preset. The display shows the type of heating.

You can adjust the preset temperature and the cooking time.

Meat probe

You can use the meat probe for several dishes.

If the meat probe is plugged in, only the dishes that are possible with the meat probe are available for selection. For each dish, you receive recommended settings for type of heating, temperature and core temperature. You can adjust the temperature and the core temperature.

→ "Meat probe", Page 19

Baking sensor

The appliance automatically bakes some dishes with the baking sensor.

 appears on the display. You do not have to implement any further settings.

Observe the information for the baking sensor.

→ "Dishes with baking sensor", Page 21

Microwave dishes

The appliance activates the microwave automatically for certain dishes. This significantly reduces the cooking time.

Take note of the information for the microwave.

→ "Microwave", Page 16

13.3 Overview of the dishes

You can find out which individual dishes are available to you on the appliance when you call up the operating mode.

The dishes are sorted by categories and food.

Category	Foods
Cakes, bread	Cakes Small baked items Biscuits Bread, bread rolls Savoury cakes, pizza, quiche
Bakes, soufflés	Fresh lasagne Soufflés in individual molds Fruit crumble Yorkshire pudding
Frozen products	Pizza Bread rolls Bakes Potato products Poultry, fish
Poultry	Chicken Duck, goose Turkey

Category	Foods
Meat	Pork Beef Lamb Meat dishes
Fish	Fish
Side dishes, vegetables	Vegetables Potatoes Rice Cereals
Defrosting food	Bread, bread rolls Cakes Meat, poultry Fish

13.4 Dishes with baking sensor

If you select a dish that is suitable for the baking sensor, the appliance regulates the baking process completely automatically.

The baking sensor in the cooking compartment and the appliance regulates the settings automatically.

The appliance automatically bakes the following dishes with the baking sensor.

Category	Food/dishes
Cakes, bread	Cakes <ul style="list-style-type: none"> ■ Cakes in tins ■ Cakes on a baking tray ■ Pies/tarts Small baked items <ul style="list-style-type: none"> ■ Puff pastry ■ Muffins ■ Leavened cake Bread, bread rolls <ul style="list-style-type: none"> ■ Bread rolls ■ Bread ■ Flatbread Savoury cakes, pizza, quiche <ul style="list-style-type: none"> ■ Savoury cakes, quiche ■ Pizza ■ Tarte flambée

Suitable baking tins

For an optimal baking result, use dark-coloured metal baking tins.

ATTENTION!

Using silicone moulds or any film, covers or accessories that contain silicone could damage the baking sensor. Damage may occur even if the baking sensor is not active.

- ▶ Do not use silicone moulds or any film, covers or accessories that contain silicone.
- ▶ Never place objects made of silicone in the cooking compartment.

13.5 Adjusting the dish

Note: Once it has started, you can no longer change or interrupt the dish or the settings.

Requirement: To start the operation, the cooking compartment must be cooled down.

1. Press menu.

2. In the operating modes menu, select "Dishes".
 - ✓ The first dish is suggested.
 3. Use the rotary selector to select the required category.
 4. Press "Continue".
 5. Use the rotary selector to select the required food.
 6. Press "Continue".
 7. Use the rotary selector to set the required dish.
 8. Press "Continue".
 9. Adjust the settings if required.
 - For some dishes, you can change the temperature, the cooking time or the end time by pressing "Adjust".
 - For some dishes, you can set the weight directly using the rotary selector.
 10. For information about the accessory and shelf position, press "Tip".
 11. Press start/stop to start the operation.
 - ✓ The appliance starts to heat and the time starts to count down. The heating line does not appear.
 - ✓ Once the dish is ready, a signal sounds. The appliance stops heating.
 12. Once the cooking time has elapsed:
 - Press start/stop to silence the audible signal manually.
 - For some dishes, you can extend the cooking time if necessary.
- "Adding extra cooking time", Page 22

- When the dish is ready, press on/off to switch the appliance off.

Adding extra cooking time

For some dishes, the appliance allows you to extend the cooking time once the set cooking time has elapsed. You can do this as often as required.

1. If you do not want to extend the cooking time, press "End" and then to switch the appliance off.
2. To extend the cooking time, press "Continue cooking".
 - ✓ A cooking time appears on the display.
3. If necessary, use the rotary selector to change the cooking time.
4. Press start/stop to start the operation.
 - ✓ The appliance starts to heat and the time starts to count down.
 - ✓ Once the cooking time has elapsed, an audible signal sounds. The appliance stops heating. The notification for extending the cooking time appears again.
5. Once the cooking time has elapsed:
 - Press start/stop to silence the audible signal manually.
 - If you want to extend the cooking time again, press "Continue cooking".
 - When the dish is ready, press "End" and use on/off to switch the appliance off.



14 Childproof lock

You can secure your appliance to prevent children from accidentally switching it on or changing the settings.

14.1 Activating and deactivating the childproof lock

You can activate and deactivate the childproof lock regardless of whether the appliance is switched on or off.

1. Press and hold  for approx. four seconds to activate the childproof lock.

- ✓ A confirmation notification appears on the display.
- ✓ The  appears in the status bar when the appliance is switched on or off.
- 2. Press and hold  for approx. four seconds to deactivate the childproof lock.
- ✓ A confirmation notification appears on the display.

15 Sabbath mode

You can set a cooking time of up to 74 hours using Sabbath mode. You can use top/bottom heating to keep food warm between 85 °C and 140 °C during this time without having to switch the appliance on or off.



15.1 Starting Sabbath mode

Notes

- If you open the appliance door during operation, the appliance stops heating. When you close the appliance door, the appliance continues to heat again.
- Once it has started, you can no longer change or interrupt Sabbath mode.

Requirement: Sabbath mode is activated in the basic settings.

→ "Basic settings", Page 24

1. Use the rotary selector to set the Sabbath mode type of heating .
2. Press the temperature.
 - The temperature is preset to 85 °C.
3. Use the rotary selector to set the desired temperature.
4. Press .
 - The time is preset to 25 hours.
5. Use the rotary selector to set the cooking time.
 - The end time cannot be delayed.
6. Press start/stop to start the operation.
 - ✓ The appliance starts to heat and the time starts to count down.

- Once the cooking time has elapsed, an audible signal sounds. A note appears on the display confirming that the operation has finished. The appliance stops heating up and responds again as usual outside of Sabbath mode.

- Press on/off to switch the appliance off. The appliance automatically switches off after approx. 10 to 20 minutes.

16 Home Connect

This appliance is network-capable. Connecting your appliance to a mobile device lets you control its functions via the Home Connect app, adjust its basic settings and monitor its operating status.

The Home Connect services are not available in every country. The availability of the Home Connect function depends on the availability of Home Connect services in your country. You can find information about this at: www.home-connect.com.

The Home Connect app guides you through the entire login process. Follow the instructions in the Home Connect app to configure the settings.

Tips

- Please consult the documents supplied by Home Connect.
- Please also follow the instructions in the Home Connect app.

Notes

- Please note the safety precautions in this instruction manual and make sure that they are also observed when operating the appliance via the Home Connect app.
→ "Safety", Page 2
- Operating the appliance on the appliance itself always takes priority. During this time it is not possible to operate the appliance using the Home Connect app.
- In networked standby mode, the appliance requires a maximum of 2 W.

16.1 Setting up Home Connect

Requirements

- The appliance is connected to the power supply and is switched on.
 - You have a mobile device with a current version of the iOS or Android operating system, e.g. a smartphone.
 - The mobile device and the appliance are within range of your home network's Wi-Fi signal.
1. Download the Home Connect app.



2. Open the Home Connect app and scan the following QR code.



3. Follow the instructions in the Home Connect app.

16.2 Home Connect Settings

You can adjust the settings and network settings for Home Connect by going to your appliance's basic settings. Which settings the display shows will depend on whether Home Connect has been set up and whether the appliance is connected to your home network.

Basic setting	Possible settings	Explanation
Wi-Fi	Switch on Switch off	If Wi-Fi is activated, you can use Home Connect. In networked standby mode, the appliance requires a maximum of 2 W.
Network	Connect to network Disconnect from network	If you disconnect the appliance from the network, all network information will be deleted. This setting is useful if you have new login details for the router.
Connect to app	-	This setting initiates the connection between the Home Connect app and the appliance.
Remote control	On Off	When this function is deactivated, all you can do is view the appliance's operating status in the app. When this function is activated, you can remotely start and control the appliance.
Appliance information ⓘ	-	The display shows information about the network or the appliance.

16.3 Operating the appliance with the Home Connect app

When the Remote start function is activated, you can use the Home Connect app to remotely configure the appliance's settings and start it.

Note: Some operating modes can only be started on the oven itself.

Requirements

- The appliance must be switched on.
- The appliance must be connected to your home network and to the Home Connect app.
- To configure the appliance's settings using the Home Connect app, "Remote control" must be switched on in the basic settings. When the Remote start function is deactivated, only the appliance's operating statuses are displayed in the Home Connect app.

1. Tap menu.
2. Tap "Remote start".
- ✓ The display will show .
3. Configure a setting in the Home Connect app and send it to the appliance.

Notes

- If you open the appliance door within 15 minutes of activating the Remote start function or of the set program ending, the Remote start function will be deactivated.
- When you start the oven using the controls on the appliance itself, the Remote start function is activated automatically. You can use the Home Connect app to adjust the settings or start a new program.

16.4 Software update

Your appliance's software can be updated using the software update function, e.g. for the purposes of optimisation, troubleshooting or security updates. To do this, you must be a registered Home Connect user, have installed the app on your mobile device and be connected to the Home Connect server. As soon as a software update is available, you will be informed via the Home Connect app and will be able to start the software update via the app. Once the update

has been successfully downloaded, you can start installing it via the Home Connect app if you are in your WLAN home network (Wi-Fi). The Home Connect app will inform you once installation is successful.

Notes

- You can continue to use your appliance as normal while updates are downloading. Depending on your personal settings in the app, software updates can also be set to download automatically.
- We recommend that you install security updates as soon as possible.

16.5 Remote diagnostics

Customer Service can use Remote Diagnostics to access your appliance if you contact them, have your appliance connected to the Home Connect server and if Remote Diagnostics is available in the country in which you are using the appliance.

Tip: For further information and details about the availability of Remote Diagnostics in your country, please visit the service/support section of your local website: www.home-connect.com

16.6 Data protection

Please see the information on data protection. The first time your appliance is registered on a home network connected to the Internet, your appliance will transmit the following types of data to the Home Connect server (initial registration):

- Unique appliance identification (consisting of appliance codes as well as the MAC address of the Wi-Fi communication module installed).
- Security certificate of the Wi-Fi communication module (to ensure a secure data connection).
- The current software and hardware version of your appliance.
- Status of any previous reset to factory settings.

This initial registration prepares the Home Connect functions for use and is only required when you want to use the Home Connect functions for the first time.

Note: Please note that the Home Connect functions can only be utilised with the Home Connect app. Information on data protection can be retrieved in the Home Connect app.

17 Basic settings

You can configure the appliance to meet your needs.

17.1 Overview of the basic settings

Here you can find an overview of the basic settings and factory settings. The basic settings depend on the features of your appliance.

Basic setting	Selection
Language	See selection on the appliance.
Clock	Clock in 24-hour format.
Date – day	Sets the current day

¹ Factory setting (may vary according to model)

Basic setting	Selection
Date – month	Sets the current month
Date – year	Sets the current year
Signal tone	Short cooking time Medium cooking time ¹ Long cooking time
Volume	Five levels
Button tone	Switched on Switched off ¹
Display brightness	5 settings

¹ Factory setting (may vary according to model)

Basic setting	Selection
Clock display	off Digital + date ¹ Analogue
Lighting	Off during operation On during operation ¹
Auto resume (only applicable for the Microwave operating mode)	Do not resume microwave automatically ¹ When closing the door
Childproof lock	Keylock only ¹ Door lock + keylock
After switch-on	Main menu Types of heating ¹ Microwave Microwave combination Dishes
Warning: Baking tray in MW	Display ¹ Do not display
Night-time dimming	Switched off ¹ Switched on
Brand logo	Display ¹ Do not display
Dry microwave	Switched on ¹ Switched on ¹
Fan run-on	Recommended ¹ Minimum

¹ Factory setting (may vary according to model)

Basic setting	Selection
Telescopic rails	Retrofitted ¹ Not retrofitted
Sabbath mode	Switched on Switched off ¹
Home Connect	Home Connect Settings → "Home Connect", Page 23
Factory setting	Reset

¹ Factory setting (may vary according to model)

17.2 Changing the basic settings

1. Press on/off.
2. Press menu.
 - ✓ The operating modes menu opens.
3. Select the "Settings" operating mode.
 - ✓ The first basic setting appears.
4. Press √ to switch between the different settings.
5. Use the rotary selector to change the basic setting.
6. Press menu.
 - ✓ The display shows the changes "Save" or "Discard".
7. Press the required change.

Note: Your changes to the basic settings will be retained even after a power failure.

Discarding changes to the basic settings

1. Press menu.
2. Press "Discard".
 - ✓ All your changes are discarded and not saved.

18 Cleaning and servicing

To keep your appliance working efficiently for a long time, it is important to clean and maintain it carefully.

18.1 Cleaning products

In order to avoid damaging the various oven surfaces on the appliance, do not use unsuitable cleaning products.

WARNING – Risk of electric shock!

An ingress of moisture can cause an electric shock.

- ▶ Do not use steam- or high-pressure cleaners to clean the appliance.

Suitable cleaning agents

Only use cleaning agents that are suitable for the different surfaces on your appliance.

ATTENTION!

Unsuitable cleaning products may damage the surfaces of the appliance.

- ▶ Do not use harsh or abrasive cleaning products.
- ▶ Do not use cleaning products with a high alcohol content.
- ▶ Do not use hard scouring pads or cleaning sponges.
- ▶ Do not use any special cleaners for cleaning the appliance while it is hot.

Using oven cleaner in a hot cooking compartment damages the enamel.

- ▶ Never use oven cleaner in the cooking compartment when it is still warm.
- ▶ Remove all food remnants from the cooking compartment and the appliance door before you next heat up the appliance.

New sponge cloths contain residues from production.

- ▶ Wash new sponge cloths thoroughly before use.

Follow the instructions on cleaning the appliance.
→ "Cleaning the appliance", Page 27

Appliance front

Surface	Suitable cleaning agents	Information
Stainless steel	<ul style="list-style-type: none"> ▪ Hot soapy water ▪ Special stainless steel cleaning products suitable for hot surfaces 	To prevent corrosion, remove any limescale, grease, starch or albumin (e.g. egg white) stains on stainless steel fronts immediately. Apply a thin layer of the stainless steel cleaning product with a soft cloth.
Plastic or painted surfaces E.g. control panel	<ul style="list-style-type: none"> ▪ Hot soapy water 	Do not use glass cleaner or a glass scraper. To avoid permanent stains, remove any descaling agent that gets onto the surface immediately.

Appliance door

Area	Suitable cleaning agents	Information
Door panels	<ul style="list-style-type: none"> ▪ Hot soapy water 	Do not use a glass scraper or a stainless steel wool. Tip: Remove the door panels in order to clean them thoroughly. → "Appliance door", Page 29
Door cover	<ul style="list-style-type: none"> ▪ Made of stainless steel: Stainless steel cleaner ▪ Made of plastic: Hot soapy water 	Do not use glass cleaner or a glass scraper. Do not use stainless steel care products. Tip: Remove the door cover for thorough cleaning. → "Appliance door", Page 29
Stainless steel interior door frame	Stainless steel cleaner	Discolouration can be removed using stainless steel cleaner. Do not use stainless steel care products.
Door handle	<ul style="list-style-type: none"> ▪ Hot soapy water 	To avoid permanent stains, remove any descaling agent that gets onto the surface immediately.
Door seal	<ul style="list-style-type: none"> ▪ Hot soapy water 	Do not remove or scrub.

Cooking compartment

Area	Suitable cleaning agents	Information
Enamel surfaces	<ul style="list-style-type: none"> ▪ Hot soapy water ▪ Vinegar water ▪ Oven cleaner 	Soak any heavily soiled areas and use a brush or steel wool. Leave the appliance door open to dry the cooking compartment after cleaning it. Notes <ul style="list-style-type: none"> ▪ It is best to use the cleaning function. → "Self-cleaning", Page 27 ▪ Enamel burns at very high temperatures, causing minor discolouration. The functionality of your appliance is not affected by this. ▪ The edges of thin trays cannot be completely enamelled and may be rough. This does not impair corrosion protection. ▪ Food residues will leave a white coating on the enamel surfaces. The coating does not pose a health risk. The functionality of your appliance is not affected by this. You can remove residues with lemon juice.
Glass cover for the oven light	<ul style="list-style-type: none"> ▪ Hot soapy water 	Use oven cleaner to remove very heavy soiling.
Rails	<ul style="list-style-type: none"> ▪ Hot soapy water 	Soak any heavily soiled areas and use a brush or steel wool. Note: To clean thoroughly, detach the rails. → "Rails", Page 31
Pull-out system	<ul style="list-style-type: none"> ▪ Hot soapy water 	Use a brush to remove very heavy soiling. Clean the pull-out rails while they are pushed in so that you do not remove the lubricant. Do not clean in the dishwasher. Note: To clean thoroughly, detach the pull-out system. → "Rails", Page 31

Area	Suitable cleaning agents	Information
Accessories	<ul style="list-style-type: none"> ■ Hot soapy water ■ Oven cleaner 	Soak any heavily soiled areas and use a brush or steel wool. Enamelled accessories are dishwasher-safe.
Meat probe	<ul style="list-style-type: none"> ■ Hot soapy water 	Use a brush to remove heavy soiling. Do not clean in the dishwasher.

18.2 Cleaning the appliance

In order to avoid damaging the appliance, you must clean your appliance only as specified, and with suitable cleaning products.

WARNING – Risk of burns!

The appliance and its parts that can be touched become hot during use.

- ▶ Caution should be exercised here in order to avoid touching heating elements.
- ▶ Young children under 8 years of age must be kept away from the appliance.

WARNING – Risk of fire!

Loose food remnants, fat and meat juices may catch fire.

- ▶ Before using the appliance, remove the worst of the food residues and remnants from the cooking compartment, heating elements and accessories.

Requirement: Read the information on cleaning products.

→ "Cleaning products", Page 25

1. Clean the appliance using hot soapy water and a dish cloth.
 - For some surfaces, you can use alternative cleaning agents.
 - "Suitable cleaning agents", Page 25
2. Dry with a soft cloth.

19 Self-cleaning

With the self-cleaning cleaning function, the cooking compartment is cleaned virtually automatically. Use the "Self-cleaning" to clean the cooking compartment every two to three months. You can use the "Self-cleaning" more often, if required. The "Self-cleaning" requires approx. 2.5–4.7 kilowatt hours.

19.1 Preparing the appliance for the cleaning function

To achieve a good cleaning result and prevent damage, prepare the appliance carefully.

WARNING – Risk of fire!

Combustible objects that are left in the cooking compartment may catch fire.

- ▶ Never store combustible objects in the cooking compartment.
- ▶ If smoke is emitted, the appliance must be switched off or the plug must be pulled out and the door must be held closed in order to stifle any flames.

Loose food remnants, fat and meat juices may catch fire when the cleaning function is in progress.

- ▶ Before you start the cleaning function, always remove coarse dirt from the cooking compartment.
- ▶ Never clean accessories at the same time.

The outside of the appliance gets very hot when the cleaning function is in progress.

- ▶ Never hang combustible objects, e.g. tea towels, on the door handle.
- ▶ Leave the front of the appliance clear.
- ▶ Keep children at a safe distance.

If the door seal is damaged, a large amount of heat is generated around the door.

- ▶ Do not scrub or remove the seal.
- ▶ Never operate the appliance if the seal is damaged or missing.

1. Remove accessories and cookware from the cooking compartment.
 - You can also clean the shelf supports along with the pull-out rails.
2. Remove coarse dirt from the cooking compartment and from the rails.
3. Use a detergent solution and a soft cloth to clean the surfaces at the edges of the cooking compartment around the door seal.
 - Do not remove or scrub the door seal.
 - Use oven cleaner to remove stubborn dirt from the inner door pane.
4. Remove any objects from the cooking compartment. The cooking compartment must be empty except for the rails.

19.2 Setting the self-cleaning function

Ventilate the kitchen while the cleaning function is running.

WARNING – Risk of harm to health!

The cleaning function heats up the cooking compartment to a very high temperature so that food left over from roasting, grilling and baking will burn off. This process releases vapours, which can irritate mucous membranes.

- ▶ Keep the kitchen well ventilated while the cleaning function is running.
- ▶ Do not remain in the room for long periods.
- ▶ Keep children and pets away.

WARNING – Risk of burns!

The cooking compartment gets very hot when the cleaning function is in progress.

- ▶ Never open the appliance door.
- ▶ Allow the appliance to cool down.
- ▶ Keep children at a safe distance.

-  The outside of the appliance gets very hot when the cleaning function is in progress.
- ▶ Never touch the appliance door.
 - ▶ Allow the appliance to cool down.
 - ▶ Keep children at a safe distance.

Requirement: → "Preparing the appliance for the cleaning function", Page 27.

1. Press menu.
2. Select "Self-cleaning" in the operating mode menu.
3. Use the rotary selector to set the cleaning setting.

Cleaning setting	Cleaning level	Duration in hours
1	Light	Approx. 1:15
2	Medium	Approx. 1:30
3	High	Approx. 2:00

Select a higher cleaning setting for heavier or older soiling.

The duration cannot be changed.

4. Press start/stop.
- ✓ A notification stating that you should carry out the necessary preparatory work for the cleaning function appears in the display.
5. Press start/stop to start.
- ✓ The cleaning function starts and the duration counts down. The heating line does not appear.
 - ✓ For your safety, the appliance door locks once a certain temperature is reached in the cooking compartment.

- ✓ When the cleaning function ends, a signal sounds and the duration is at zero in the display.
6. Press on/off to switch the appliance off. When the appliance has cooled down sufficiently, the appliance door is unlocked and goes out.
 7. → "Preparing the appliance for use following the cleaning function", Page 28.

19.3 Preparing the appliance for use following the cleaning function

1. Allow the appliance to cool down.
2. Wipe off any ash that has been left behind in the cooking compartment, on the rails and around the appliance door with a damp cloth.
3. Slide the pull-out rails in and out several times. While the cleaning function is running, the rails may become discoloured. This discolouration does not compromise the functionality of the appliance.
4. Remove white residues with lemon juice.

Note: White residues on the enamel surfaces may be caused by heavy soiling. These food residues are harmless. The deposits do not compromise the functionality of the appliance.

Note: While the cleaning function is running, the frame on the inside of the appliance door becomes discoloured. This discolouration does not compromise the functionality of the appliance. Use stainless steel cleaner to remove the discolouration.

20 Cleaning assistance

The cleaning assistance is a quick alternative for occasionally cleaning the cooking compartment. The cleaning assistance softens dirt by vaporising the soapy water. It is then easier to remove dirt.

20.1 Setting the cleaning aid

WARNING – Risk of scalding!

If there is water in the cooking compartment when it is hot, this may create hot steam.

- ▶ Never pour water into the cooking compartment when the cooking compartment is hot.

Requirement: The cooking compartment has cooled down completely.

1. Remove the accessories from the cooking compartment.
2. Mix 0.4 litres water with a drop of washing-up liquid and pour into the centre of the cooking compartment floor.
Do not use distilled water.
3. Press on/off.
- ✓ A type of heating and a temperature appears.
4. Use the rotary selector to set the bottom heat type of heating.
5. Press the temperature.
6. Use the rotary selector to set the temperature to 80 °C.
7. Press .

8. Use the rotary selector to set the time to four minutes.
9. Press start/stop to start.
- ✓ The appliance starts to heat and the time starts to count down.
- ✓ Once the time has elapsed, an audible signal sounds. A message appears in the status bar.
10. Use on/off to switch the appliance off and leave the cooking compartment to cool for approx. 20 minutes.

20.2 Wiping down the cooking compartment

ATTENTION!

The prolonged presence of moisture in the cooking compartment leads to corrosion.

- ▶ After using the cleaning assistance, wipe the cooking compartment and allow it to dry completely.

Requirement: The cooking compartment must have cooled down.

1. Open the appliance door and remove the remaining water with an absorbent sponge cloth.
2. Clean the smooth surfaces in the cooking compartment with a dish cloth or a soft brush. Remove stubborn food remnants using a stainless steel scouring pad.

- Remove limescale with a cloth soaked in vinegar. Then wipe with clean water and rub dry with a soft cloth (including under the door seal).

- In order to dry the cooking compartment, leave the appliance door open in the detent position (approx. 30°) for approx. one hour.

21 Drying

To prevent residual moisture, dry the cooking compartment following operation.

ATTENTION!

If there is water on the cooking compartment floor when operating the appliance at temperatures above 120 °C, this will damage the enamel.

- ▶ Do not use the appliance if there is water on the cooking compartment floor.
- ▶ Wipe away any water on the cooking compartment floor before operation.

21.1 Drying the cooking compartment

You can dry the cooking compartment by hand or use the drying function.

- Allow the appliance to cool down.
- Remove dirt from the cooking compartment.
- Wipe away the water in the cooking compartment.
- Dry the cooking compartment.
 - Leave the appliance door open for one hour to dry the cooking compartment by hand.

- In order to use the drying function, set the drying function.

→ "Setting the drying process", Page 29

Setting the drying process

- Allow the appliance to cool down.
- Remove coarse dirt from the cooking compartment and wipe away moisture from the cooking compartment floor.
- Press menu.
- In the operating mode menu, press the drying operating mode.

The duration is set to 10:00 min. and cannot be changed.
- Press *start/stop* to start the drying function.
- ✓ The appliance starts to dry and the duration counts down.
 - Once the duration has elapsed:
 - A message appears in the display.
 - Press *start/stop* to silence the audible signal before it is due to end.
 - Press *on/off* to switch the appliance off.

22 Appliance door

To clean the appliance door thoroughly, you can disassemble the appliance door.

22.1 Removing the door cover

The stainless steel inlay in the door cover may discolor. Remove the door cover in order to clean it and the stainless steel inlay, or to remove the door panes.

- Open the appliance door slightly.
- Press down on the left- and right-hand sides of the door cover.
- Remove the door cover and carefully close the appliance door.

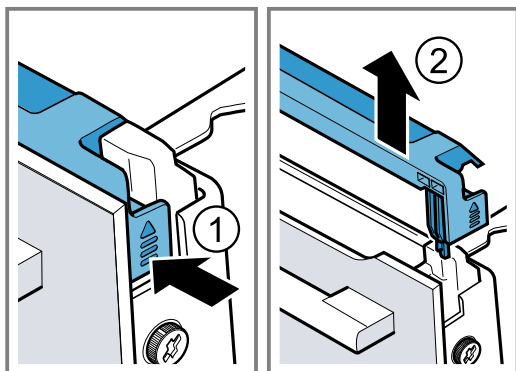

22.2 Removing the door panes

⚠ WARNING – Risk of injury!

Scratched glass in the appliance door may develop into a crack.

- ▶ Do not use any harsh or abrasive cleaners or sharp metal scrapers to clean the glass on the oven door, as they may scratch the surface.

The hinges on the appliance door move when the door is opened and closed, which could trap your fingers.

- ▶ Keep your hands away from the hinges. Components inside the appliance door may have sharp edges.

- ▶ Wear protective gloves.

Requirement: The door cover has been removed.

- Undo and remove the screws on the left and right of the appliance door.
- Place a folded-up tea towel in the appliance door.

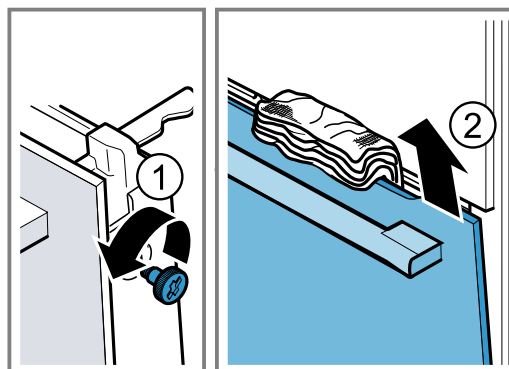

3. Close the appliance door.
4. Pull the front pane up and out.
5. Place the front pane down on a flat surface with the door handle facing down.
6. Press the intermediate pane against the appliance with one hand while pushing the left- and right-hand retainers **a** upwards. Do not detach the retainers **a**.

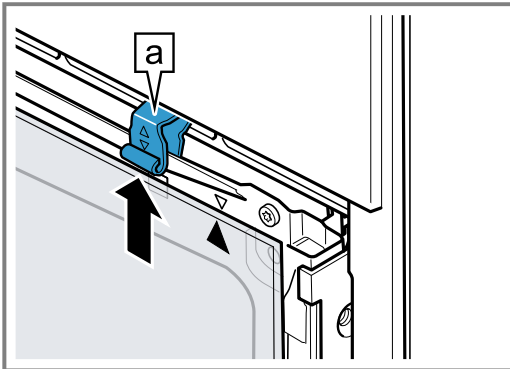

7. Remove the intermediate pane.
8. **⚠ WARNING – Risk of serious harm to health!**
If the screws are undone, the safety of the appliance can no longer be guaranteed. Microwave energy may escape.
▶ Never undo the screws.
Never unscrew the four black screws on the frame.

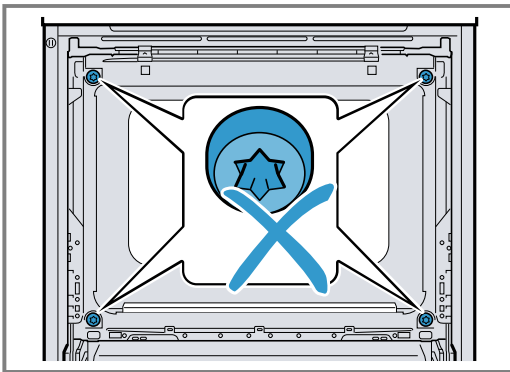

22.3 Fitting the door panes

- ⚠ WARNING – Risk of injury!**
The hinges on the appliance door move when the door is opened and closed, which could trap your fingers.
▶ Keep your hands away from the hinges.
Components inside the appliance door may have sharp edges.
▶ Wear protective gloves.

1. Turn the intermediate pane until the arrow **a** is in the top right.

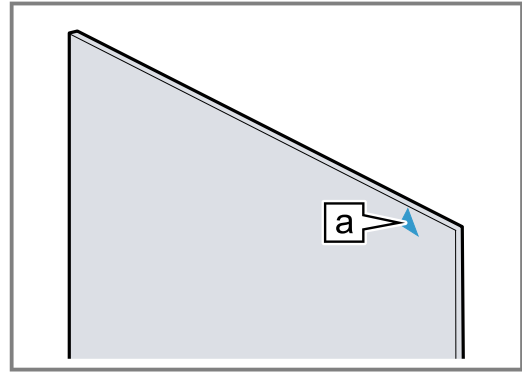

2. Insert the intermediate pane into the retainer **a** at the bottom ① and push it in firmly at the top.
3. Push the left- and right-hand retainer **a** downwards until the intermediate pane is clamped ②.

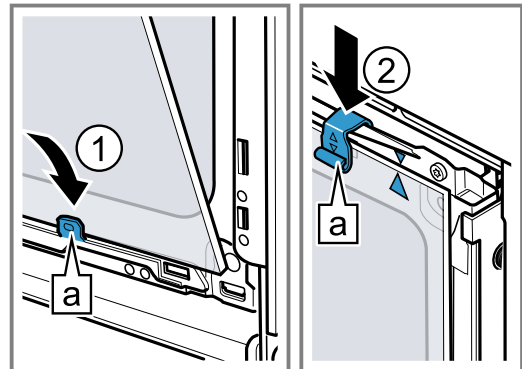

4. Attach the front pane downwards into the left- and right-hand retainers **a** ①.
5. Push the front pane to the appliance until the left- and right-hand hook **a** is opposite the support **b** ②.

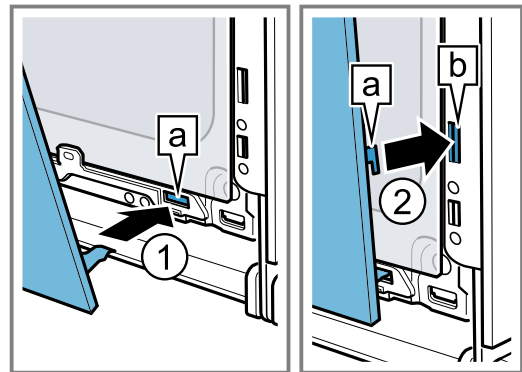

6. Push the front pane in at the bottom ① until you hear it click into place.
7. Open the appliance door slightly and remove the tea towel.
8. Screw both screws back in on the left and right of the appliance door.

9. Put the door cover in position and push down on it ② until you hear it click into place.

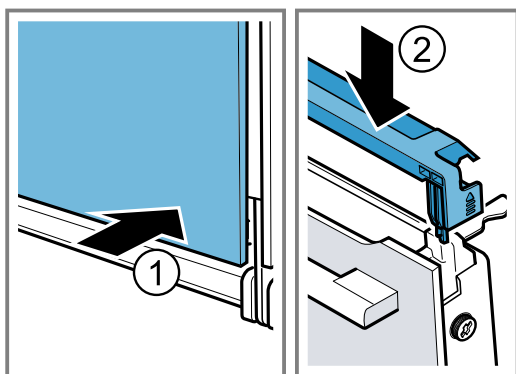

10. Close the appliance door.

Note: Do not use the cooking compartment again until the door panes have been correctly fitted.

23 Rails

To thoroughly clean the rails and the cooking compartment, or to replace the rails, you can remove the rails.

23.1 Detaching the rails

⚠ WARNING – Risk of burns!

The shelf supports get very hot

- ▶ Never touch the shelf supports when hot.
- ▶ Always allow the appliance to cool down.
- ▶ Keep children at a safe distance.

1. Pull out the pull-out forwards.
2. Lift the rail forwards slightly ① and detach it ②.
3. Swivel the entire rail outwards ③ and unhook it at the rear ④.

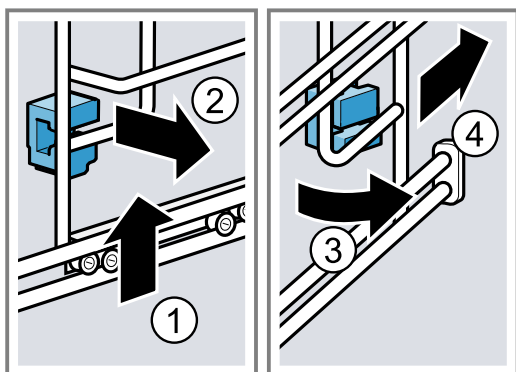

23.2 Fitting the retainers

The retainers may fall out when you detach the rails.

Note:

The retainers at the front differ from those at the rear.

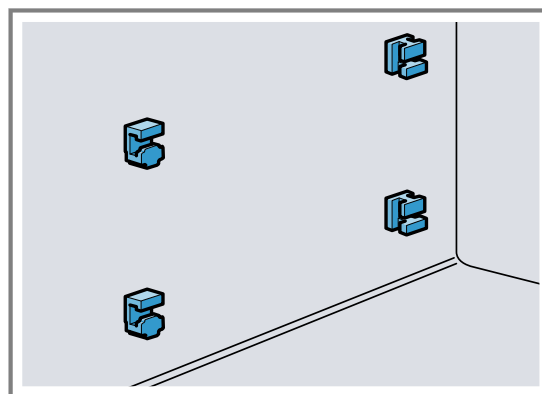

1. Hook the front retainers with the hook into the round hole at the top and set them at a slight angle ①.
2. Hook the front retainers in at the bottom and straighten them ②.

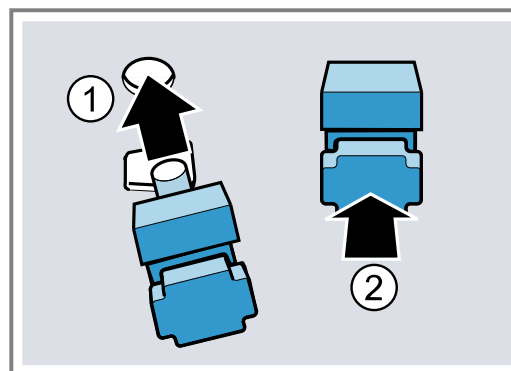

- Hook the rear retainers with the hook into the top hole ① and push them into the bottom hole ②.

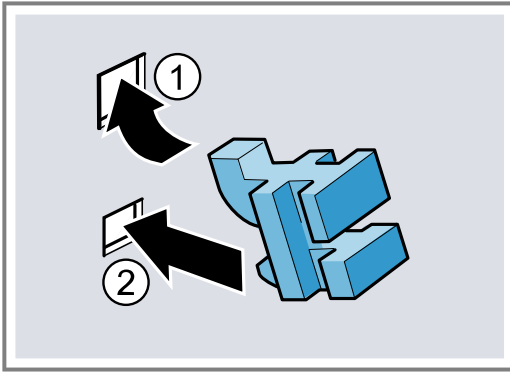

- The rails only fit on the right or left.
- For both pull-out rails, ensure that you can pull them forwards and out.

- Set the rear rail at an angle, hooking it into the retainers at the top and bottom ①.
- Pull the rail forwards ②.
- Hook in the rail at the front ③ and press it down ④.

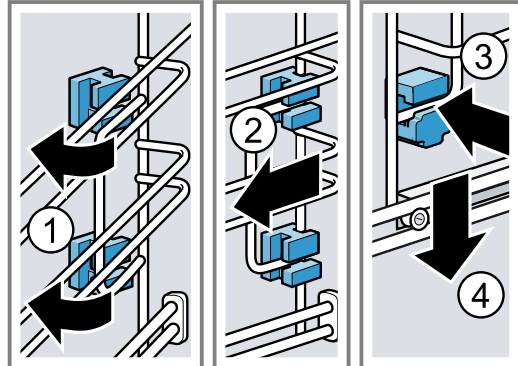

- Push the pull-outs in completely.

23.3 Attaching the rails

Notes

- When hanging the rails, ensure that the pull-out is at the bottom.

24 Troubleshooting

You can rectify minor faults on your appliance yourself. Read the troubleshooting information before contacting after-sales service. This will avoid unnecessary costs.

⚠ WARNING – Risk of injury!

Improper repairs are dangerous.

- Repairs to the appliance should only be carried out by trained specialist staff.
- If the appliance is defective, call Customer Service.



⚠ WARNING – Risk of electric shock!

Incorrect repairs are dangerous.

- Repairs to the appliance should only be carried out by trained specialist staff.
- Only use genuine spare parts when repairing the appliance.
- If the power cord of this appliance is damaged, it must be replaced by the manufacturer, the manufacturer's Customer Service or a similarly qualified person in order to prevent any risk.

24.1 Malfunctions

Fault	Cause and troubleshooting
The appliance is not working.	The circuit breaker is faulty. <ul style="list-style-type: none"> Check the circuit breaker in the fuse box. There has been a power cut. <ul style="list-style-type: none"> Check whether the lighting in your kitchen or other appliances are working.
"Sprache Deutsch" appears in the display.	There has been a power cut. <ul style="list-style-type: none"> Implement the settings for the initial configuration. <ul style="list-style-type: none"> → "Carrying out the initial configuration", Page 13
The operation does not start or is interrupted.	Malfunction <ul style="list-style-type: none"> Call the after-sales service. <ul style="list-style-type: none"> → "Customer Service", Page 34 Different causes are possible. <ul style="list-style-type: none"> Check any notifications that appear in the display. <ul style="list-style-type: none"> → "Displaying information", Page 14
Appliance does not heat up and "Demo mode is switched on" appears in the display.	Device is in demo mode. <ol style="list-style-type: none"> Briefly disconnect the appliance from the power supply by switching the circuit breaker in the fuse box off and back on again. Switch off demo mode within three minutes in the <ul style="list-style-type: none"> → "Basic settings", Page 24.

Fault	Cause and troubleshooting
Appliance does not heat up and "Demo mode is switched on" appears in the display.	There has been a power cut. <ul style="list-style-type: none"> ▶ Open and close the appliance door once after a power failure. ✓ The appliance is checked and is ready to use.
The appliance does not start and "Cooking compartment too hot" appears in the display.	The cooking compartment is too hot for the selected dish or type of heating. <ul style="list-style-type: none"> ▶ Allow the cooking compartment to cool down and start again.
The time is not displayed when the appliance is switched off.	Basic setting has been changed. <ul style="list-style-type: none"> ▶ Change the basic setting for the time display. → "Basic settings", Page 24
Appliance door cannot be opened.	The cleaning function locks the appliance door;  lights up in the display. <ul style="list-style-type: none"> ▶ Allow the appliance to cool down until  goes out in the display. The childproof lock locks the appliance door. <ul style="list-style-type: none"> ▶ Use the  button to deactivate the childproof lock. → "Childproof lock", Page 22 You can switch off the lock in the basic settings. → "Basic settings", Page 24
HomeConnect is not working correctly.	Different causes are possible. <ul style="list-style-type: none"> ▶ Go to www.home-connect.com.
During simple microwave operation, the cooking compartment becomes hot.	The drying function is switched on.
The interior lighting does not work.	The LED light is defective. <p>Note: Do not remove the glass cover.</p> <ul style="list-style-type: none"> ▶ Call the after-sales service. → "Customer Service", Page 34
Maximum operating time reached.	To prevent an unwanted permanent operation, the appliance automatically stops heating after several hours if the settings are unchanged. A message appears in the display. The point at which the maximum operating time is reached is determined by the corresponding settings for an operating mode. <ol style="list-style-type: none"> 1. To continue operation, switch off the appliance with on/off first. 2. Then use on/off to switch on the appliance and set the required operation. <p>Tip: To prevent the appliance from switching off when you do not want it to, set a cooking time.</p>
A message with "D" or "E" appears in the display, e.g. D0111 or E0111.	The electronics have detected a fault. <ol style="list-style-type: none"> 1. Switch the appliance off and on again. <ul style="list-style-type: none"> ✓ If the fault was a one-off, the message disappears. 2. If the message appears again, call the after-sales service. Please specify the exact error message when calling. → "Customer Service", Page 34
The cooking result is not satisfactory.	Settings were unsuitable. Setting values, e.g. temperature or cooking time, depend on the recipe, quantity and food. <ul style="list-style-type: none"> ▶ Next time, set lower or higher values. <p>Tip: A lot of information about the food preparation and corresponding setting values can be found on our website www.siemens-home.bsh-group.com.</p>

25 Disposal

Find out here how to dispose of old appliances correctly.

25.1 Disposing of old appliance

Valuable raw materials can be reused by recycling.

1. Unplug the appliance from the mains.
2. Cut through the power cord.
3. Dispose of the appliance in an environmentally friendly manner.

Information about current disposal methods are available from your specialist dealer or local authority.



This appliance is labelled in accordance with European Directive 2012/19/EU concerning used electrical and electronic appliances (waste electrical and electronic equipment - WEEE).

The guideline determines the framework for the return and recycling of used appliances as applicable throughout the EU.

26 Customer Service

If you have any queries on use, are unable to rectify faults on the appliance yourself or if your appliance needs to be repaired, contact Customer Service. Function-relevant genuine spare parts according to the corresponding Ecodesign Order can be obtained from Customer Service for a period of at least 10 years from the date on which your appliance was placed on the market within the European Economic Area.

Note: Under the terms of the manufacturer's warranty the use of Customer Service is free of charge.

Detailed information on the warranty period and terms of warranty in your country is available from our after-sales service, your retailer or on our website.

If you contact Customer Service, you will require the product number (E-Nr.) and the production number (FD) of your appliance.

The contact details for Customer Service can be found in the enclosed Customer Service directory or on our website.

This product contains light sources from energy efficiency class G. These light sources are available as a spare part and should only be replaced by trained specialist staff.

26.1 Product number (E-Nr.) and production number (FD)

You can find the product number (E-Nr.) and the production number (FD) on the appliance's rating plate. You will see the rating plate with these numbers if you open the appliance door.

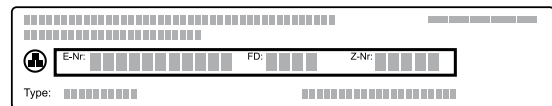

Make a note of your appliance's details and the Customer Service telephone number to find them again quickly.

27 Declaration of Conformity

BSH Hausgeräte GmbH hereby declares that the appliance with Home Connect functionality conforms to the basic requirements and other relevant provisions of Directive 2014/53/EU.

A detailed RED Declaration of Conformity can be found online at www.siemens-home.bsh-group.com among the additional documents on the product page for your appliance.



Hereby, BSH Hausgeräte GmbH declares that the appliance with Home Connect functionality is in compliance with relevant statutory requirements.

A detailed Declaration of Conformity can be found online at www.siemens-home.bsh-group.com/uk/ among the additional documents on the product page for your appliance.



Only applies to Great Britain

2.4 GHz band (2400–2483.5 MHz): Max. 100 mW
5 GHz band (5150–5350 MHz + 5470–5725 MHz):
Max. 100 mW

	BE	BG	CZ	DK	DE	EE	IE	EL	ES
	FR	HR	IT	CY	LI	LV	LT	LU	HU
	MT	NL	AT	PL	PT	RO	SI	SK	FI
	SE	NO	CH	TR	IS	UK (NI)			

5 GHz WLAN (Wi-Fi): For indoor use only.

AL	BA	MD	ME	MK	RS	UK	UA
----	----	----	----	----	----	----	----

5 GHz WLAN (Wi-Fi): For indoor use only.

28 How it works

Here, you can find the ideal settings for various types of food as well as the best accessories and cookware. We have perfectly tailored these recommendations to your appliance.

28.1 General cooking tips

Please take note of the following information when cooking all types of food.

- The temperature and cooking time depend on the amount of food and the recipe. Settings ranges are specified for this reason. Try using the lower values to start with.
- The setting values apply to food placed in the cooking compartment while the cooking compartment is still cold. Do not place accessories into the cooking compartment until it has finished preheating.
- Remove any accessories that are not being used from the cooking compartment.

28.2 Baking tips

- Dark-coloured metal baking tins are most suitable for baking cakes, bread and other baked goods.
- Use wide, shallow cookware for bakes and gratins. Food takes longer to cook in deep, narrow cookware and it browns more on top.
- Silicone moulds are not suitable.
- If you are cooking bakes directly in the universal pan, place the universal pan into the cooking compartment at level 1.
- The setting values for bread dough apply to both dough placed on a baking tray and dough placed in a loaf tin.

ATTENTION!

When the cooking compartment is hot, any water inside it will create steam. The change in temperature may cause damage.

- ▶ Never pour water into the cooking compartment when it is still hot.
- ▶ Never place cookware containing water on the cooking compartment floor.

Shelf positions

If you bake on one level, use shelf position 1.

Baking on 2 levels	Shelf position
Universal pan	3
Baking tray	1
Baking tins on two wire racks	3
	1

Use the 4D hot air heating function.

Notes

- Items that are placed in the appliance on baking trays or in baking tins/dishes at the same time will not necessarily be ready at the same time.
- If you opt for cooking in combination with the microwave mode, you can only cook on one level.

28.3 Roasting, braising and grilling tips

- The recommended settings are for fridge-temperature food and unstuffed, oven-ready poultry.
- Place the poultry onto the cookware breast-side or skin-side down.
- Turn roasting joints, grilled items or whole fish after approx. $\frac{1}{2}$ to $\frac{2}{3}$ of the specified time.
- The meat probe allows you to cook with absolute precision. Please take note of the important information on using it correctly. → Page 19

Calculating the cooking time, e.g. 20+35:

- To calculate the cooking time, assume 20 minutes per 500 g of meat. Then add an extra 35 minutes to that figure.
- For 1.5 kg, the cooking time would therefore be 95 minutes.

Cooking time range, e.g. 10-15:

- Your food will be ready within the specified range of time (in minutes).

Roasting on the wire rack

Food roasted on the wire rack will become very crispy on all sides. You can roast large poultry, for example, or multiple individual pieces at the same time.

- Roast pieces of a similar weight and thickness. The grilled food will brown evenly and will remain succulent and juicy.
- Place the food to be roasted directly on the wire rack.
- To catch any liquids that drip down, place the universal pan into the cooking compartment one level below the wire rack.
- Add up to $\frac{1}{2}$ litre of water to the universal pan, depending on the size and type of food that you want to roast.

You can make a sauce from the juices that are collected. This also means that less smoke is produced and the cooking compartment does not become as dirty.

Roasting in cookware

If you cover the cookware when you cook your food, this will keep the cooking compartment cleaner.

General information about roasting in cookware

- Use heat-resistant, ovenproof cookware.
- Place the cookware on the wire rack.
- Glass cookware is best.
- Follow the manufacturer's instructions for your roasting dishes.

Roasting in uncovered cookware

- Use a deep roasting dish.
- If you do not have any suitable cookware, you can use the universal pan.

Roasting in covered cookware

- Use a suitable lid that seals well.
- When roasting meat, there should be at least 3 cm between the food and the lid. The meat may expand.

WARNING – Risk of scalding!

Very hot steam may escape when the lid is opened after cooking. Steam may not be visible, depending on the temperature.

- ▶ Lift the lid in such a way that the hot steam can escape away from you.
- ▶ Keep children away from the appliance.

Grilling

Grill food if you want it to be crispy.

The "Grill" heating function is good for cooking thinner pieces of poultry, meat and fish such as steaks, drumsticks and burgers. It is also excellent for toasting bread.

Circulated air grilling is very well suited to cooking whole poultry and fish, as well as meat, e.g. roast pork with crackling.

- When grilling several food items, choose pieces that are of a similar weight and thickness. The grilled food will brown evenly and will remain succulent and juicy.
- Place the food to be grilled directly onto the wire rack.
- To catch any liquids that drip down, place the universal pan into the cooking compartment at least one level below the wire rack.

Notes

- The grill element switches on and off continuously. This is normal. The grill setting that you use determines how frequently this occurs.
- Smoke may be produced when grilling.

28.4 Cooking instructions for ready meals

- The cooking result greatly depends on the quality of the food. Pre-browning and irregularities are sometimes already present on the raw product.
- Do not use frozen products that are covered with a thick layer of ice. Remove any ice on the food.

- Distribute foods that are in the form of separate pieces, such as bread rolls and potato products, so that they are spread out flat and evenly on the accessory. Leave a little space between the individual pieces.
- Follow the manufacturer's instructions on the packaging.
- If the packaging specifies a higher value than the maximum power of the appliance, use the next lowest a higher value the next lowest wattage setting on the appliance. To achieve the same results, increase the cooking time.

28.5 Microwave cooking

If you use the microwave mode, you can reduce the cooking time considerably.

General information

- When using the microwave mode, the cooking time is determined based on the total weight. If you want to cook a quantity that differs from the specified quantity, the general rule is **Double the quantity requires just under double the cooking time.**
- The food transfers heat to the cookware. The cookware can become very hot.
- In the main part of the instruction manual, you will find information on how to configure the microwave and microwave combination oven settings.
 - → "Microwave combination", Page 18
 - → "Microwave", Page 16

Cooking, braising or steaming using the microwave mode

- Use microwave-safe cookware with a lid. Alternatively, you can use a plate or special microwaveable film to cover the dish.
- For cereal products, e.g. rice, use deep cookware with a lid. Cereal products foam a lot during cooking. Add liquid in accordance with the instructions and information provided in the recommended settings tables.
- Do not wash or dry food. Add 1-3 tablespoons of water or lemon juice to the food.
- Spread the food out so that as much of it as possible is in contact with the bottom of the cookware. Food that is in contact with the bottom will cook more quickly than food that is piled up.
- Use salt and seasoning sparingly. When cooking food using the microwave mode, most of the food's natural flavour will be retained.
- Turn or stir the food 2-3 times during cooking.
- After cooking, leave the food to rest for 2-3 minutes.

Steaming fish in the microwave

You can steam fish quickly and easily in the microwave.

1. Place the fish in microwave-safe cookware with a lid.
2. Add salt and season the fish sparingly.
3. If you are steaming a whole fish, add 1–3 tsp of water or lemon juice.
4. Use the recommended settings when configuring the appliance settings.
5. Leave the cooked fish to rest for 2–3 minutes after cooking.

Making blanchmange from blanchmange powder

1. Use a deep, microwave-safe receptacle.
2. Pour the blanchmange powder and all of the milk and sugar into the receptacle and mix.
3. Place the receptacle onto the wire rack and slide the rack into the cooking compartment.
4. Use the recommended settings when configuring the appliance settings.
5. As soon as the milk starts to rise, stir thoroughly.
6. Repeat the process until the required consistency is achieved.

Making rice pudding

1. Weigh the rice.
2. Add 4 times the amount of milk.
3. Pour the rice and milk into a deep, microwave-safe receptacle.
You can use the universal pan for large quantities.
4. Use the recommended settings when configuring the appliance settings.
5. As soon as the milk starts to rise, stir thoroughly.
6. Reduce the microwave power as indicated in the recommended settings tables.
7. Stir several times during the remaining cooking time.

Making compote

1. Weigh the fruit and place it in a closable, microwave-safe receptacle.
2. Add 1 tablespoon of water for every 100 g of fruit.

3. Add sugar and spices to taste.
4. Cover the receptacle.
5. Use the recommended settings when configuring the appliance settings.
6. Stir two or three times during the cooking time.

Using the microwave mode to make popcorn

WARNING – Risk of burns!





Airtight packaging may burst when food is heated.

- ▶ Always follow the instructions on the packaging.
 - ▶ Always use oven gloves to remove the dishes from the cooking compartment.
1. Use shallow, heat-resistant glass cookware, e.g. the lid of an ovenproof dish.
Do not use porcelain or deep plates.
 2. Place the popcorn bag onto the cookware according to the instructions on the packaging.
 3. Use the recommended settings when configuring the appliance settings.
 4. The time may need to be adjusted, depending on the product and quantity in question.
 5. Remove the popcorn bag after 1½ minutes and shake it to ensure that the popcorn doesn't burn.
 6. Place the popcorn bag back into the oven and leave it to continue popping.
 7. Once you can only hear popping noises once every 2-3 seconds, switch off the appliance and take the popcorn bag out of the oven.
 8. Wipe the cooking compartment clean afterwards.

28.6 List of foods

Recommended settings for a variety of foods, sorted into food categories.

Recommended settings for various types of food

Food	Accessory/cook-ware	Shelf position	Heating function → <i>Page 10</i>	Temperature in °C	Microwave power setting in W	Cooking time in mins
Victoria sponge cake	x 2 Baking tin, dia. 20 cm	1		160 - 170 ¹	-	20 - 30
Rich fruit cake	High Ø 23 cm tin	1		140–160	-	120–180
Fruit pie	Plate Ø 20 cm or Pie tin	1		180 - 190	-	45 - 50
Fruit pie	Plate Ø 20 cm or Pie tin	1		170–190	-	60–75
Quiche	Dark coated quiche tin	1		190–210	-	35–45

¹ Preheat the appliance.

² Bone side down

³ Do not turn

⁴ Add the food after approx. one hour.

⁵ Preheat the appliance for 5 minutes.

⁶ Preheat the appliance for three minutes.

⁷ Turn the dish several times.

⁸ Skin side down

⁹ Stir the food one or two times during cooking.

¹⁰ Place the sealed bag on the cookware.

Food	Accessory/cook-ware	Shelf position	Heating function → Page 10	Temperature in °C	Microwave power setting in W	Cooking time in mins
Bread or white bread	Loaf tin, 1 x 900 g or 2 x 450 g	1		190 - 210 ¹	-	20 - 30
Bread or white bread	Loaf tin, 1 x 900 g or 2 x 450 g	1		190-200	-	45-55
Scones	Baking tray	1		180 - 200 ¹	-	10 - 14
Biscuits	Baking tray	2		140 - 160 ¹	-	10 - 25
Small cakes	12-cup-tin	1		140 - 160 ¹	-	20 - 35
Pavlova	Baking tray	2		90 - 100 ¹	-	120 - 180
Yorkshire pudding	12-cup-tin	1		200 - 220 ¹	-	15 - 25
Pizza, home-made	Baking tray	1		200 - 220	-	20 - 30
Pizza, home-made	Baking tray	1		220 - 230	-	25 - 30
Pizza, home-made, thin crust	Pizza tray	1		210 - 230	-	20 - 30
Biscuits, 2 levels	x 2 Baking tray	3+1		140 - 160 ¹	-	15 - 30
Top side, top rump	Uncovered cook-ware	1		160 - 170	-	30 + 25
Leg, bone-in	Uncovered cook-ware	1		160 - 170	-	25 + 25
Belly	Uncovered cook-ware	1		170 - 180	-	30 + 25
Chicken, whole	Uncovered cook-ware	1		170 - 180	-	25 + 15
Turkey, crown ²	Uncovered cook-ware	1		150 - 160	-	20 + 15 ³
Turkey, whole, 4-8 kg	Universal pan	1		150 - 160	-	12 + 12 ⁴
Meat loaf, 1 kg, + 50 ml water	Uncovered cook-ware	1		170 - 190	360	30 - 40
Complete meal with chicken	Wire rack + Uncovered cook-ware	3+1		180	-	Calculation for chicken (see table above)
Bacon rashers	Wire rack	2		3 ⁵	-	1. First side 4-5 2. Second side 3-4
Sausages, 2-4 cm thick	Wire rack	2		3 ⁶	-	10-15 ⁷
Belly	Uncovered cook-ware	1		200-220	-	30 + 25
Gammon joint	Uncovered cook-ware	2		180-200	-	30 + 25
Chicken, whole	Wire rack	1		200-220	-	25 + 15
Chicken, whole, 1 kg	Covered cookware	1		230-250	360	25-35

¹ Preheat the appliance.

² Bone side down

³ Do not turn

⁴ Add the food after approx. one hour.

⁵ Preheat the appliance for 5 minutes.

⁶ Preheat the appliance for three minutes.

⁷ Turn the dish several times.

⁸ Skin side down

⁹ Stir the food one or two times during cooking.

¹⁰ Place the sealed bag on the cookware.

Food	Accessory/cook-ware	Shelf position	Heating function → Page 10	Temperature in °C	Microwave power setting in W	Cooking time in mins
Chicken portion, 4 pieces, 250 g each ⁸	Uncovered cookware	1		190–210	360	20–30
Trout, whole, 300 g each	Wire rack	2		2	90	15 - 20
Trout, whole, 300 g each	Wire rack	2		2	90	15 - 20
Lasagne, 500 g	Ovenproof dish on wire rack	1		200 - 210	360	18 - 23
Vegetables, fresh, 250 g	Covered cookware	1		-	600	8–12 ⁹
Mixed vegetables, 250 g, + 25 ml water	Covered cookware	1		-	600	10–14 ⁹
Long-grain rice, 250 g, + 500 ml water	Covered cookware	1		-	1. 600 2. 180	1. 7 - 9 2. 13 - 16
Couscous, 250 g, + 500 ml water	Covered cookware	1		-	600	6–8
Custard made from custard powder	Covered cookware	1		-	600	5–8 ⁹
Microwave popcorn, 1 x 100 g pack ¹⁰	Uncovered cookware	1		-	600	4–6
Rice pudding, 125 g + 500 ml milk	Covered cookware	2		-	1. 600 2. 180	1. 10 2. 20–25 ⁹
Yoghurt	Individual moulds	Cooking compartment floor		40–45	-	8–9 hrs

¹ Preheat the appliance.

² Bone side down

³ Do not turn

⁴ Add the food after approx. one hour.

⁵ Preheat the appliance for 5 minutes.

⁶ Preheat the appliance for three minutes.

⁷ Turn the dish several times.

⁸ Skin side down

⁹ Stir the food one or two times during cooking.

¹⁰ Place the sealed bag on the cookware.

28.7 Special cooking methods and other applications

Information and recommended settings for special cooking methods and other applications, e.g. slow cooking or preserving.

Slow cooking

Cook prime cuts of meat slowly at a low temperature, e.g. tender cuts of beef, veal, lamb or poultry.

Slow cooking poultry or meat

Note: When using the Slow cooking heating function, you cannot delay the start of the program by setting an end time.

Requirement: The cooking compartment must be cold.

1. Use fresh, clean, hygienic meat without bones.
2. Place the cookware onto the wire rack at level 1 in the cooking compartment.
3. Preheat the cooking compartment and cookware for approx. 15 minutes.
4. Sear the meat on all sides on the hob at a very high heat.
5. Immediately place the meat into the pre-warmed cookware in the cooking compartment.

To ensure that the climate in the cooking compartment remains constant, keep the cooking compartment door closed during slow cooking.

6. After slow cooking, remove the meat from the cooking compartment.

Tips for slow cooking

Here you will find tips for achieving good results when slow cooking food.

Issue	Tip
You want to slow cook a duck breast.	<ul style="list-style-type: none"> Place the cold duck breast into a pan. Sear the skin side first. Slow cook the duck breast. After slow cooking, grill the duck breast for 3 to 5 minutes until crispy.
You want to serve your slow-cooked meat as hot as possible.	<ul style="list-style-type: none"> Preheat the serving plate. Make sure that the sauces that accompany the duck breast are very hot when you serve them.

Recommended settings for slow cooking

Food	Accessory/cook-ware	Shelf position	Searing time in mins	Heating function → Page 10	Temperature in °C	Cooking time in mins
Duck breast, medium rare, 300 g each	Uncovered cook-ware	1	6 - 8		95 ¹	45 - 60
Fillet of pork, whole	Uncovered cook-ware	1	4 - 6		85 ¹	45 - 70
Fillet of beef, 1 kg	Uncovered cook-ware	1	4 - 6		85 ¹	90 - 120
Veal medallions, 4 cm thick	Uncovered cook-ware	1	4		80 ¹	40 - 60
Saddle of lamb, boneless, 200 g each	Uncovered cook-ware	1	4		85 ¹	30 - 45

¹ Preheat the appliance.

Defrosting

You can defrost frozen food in your appliance.

Tips for defrosting food

- You can use the "microwave" mode to defrost frozen fruit, vegetables, poultry, meat, fish or baked goods.
 - Remove frozen food from its packaging before you defrost it.
 - Use heat-resistant, microwave-safe cookware.
 - The recommended settings are for freezer-temperature food (-18 °C).
- Defrosting works best if you divide it into more than one step. The steps are listed one after the other in the recommended settings tables.
 - Stir or turn the food 1-2 times during defrosting. Turn large items several times. Split the food into smaller pieces as it defrosts. Remove pieces that have already defrosted from the cooking compartment.
 - Once the food has defrosted, switch off the appliance and leave the food in the appliance for another 10 to 30 minutes to allow the temperature to equalise.

Recommended settings for defrosting

Food	Accessory/cook-ware	Shelf position	Heating function → Page 10	Temperature in °C	Microwave power setting in W	Cooking time in mins
Bread, 500 g	Uncovered cook-ware	1		-	1. 180 2. 90	1. 3 2. 10 - 15
Bread rolls	Wire rack	1		140 - 160	90	2 - 4
Cakes, moist, 500 g	Uncovered cook-ware	1		-	1. 180 2. 90	1. 2 2. 10 - 15
Cakes, dry, 750 g	Uncovered cook-ware	1		-	90	10 - 15
Meat, whole, e.g. joint, raw meat, 1 kg	Uncovered cook-ware	1		-	1. 180 2. 90	1. 15 2. 20 - 30 _†
Minced meat, mixed, 500 g	Uncovered cook-ware	1		-	1. 180 2. 90	1. 5 2. 10 - 15 _†
Chicken, whole, 1.2 kg	Uncovered cook-ware	1		-	1. 180 2. 90	1. 10 2. 10 - 15 _†
Fish, whole, 300 g	Uncovered cook-ware	1		-	1. 180 2. 90	1. 3 2. 10 - 15 _†
Berries, 300 g	Uncovered cook-ware	1		-	180	5 - 10
Butter, defrosting, 125 g	Uncovered cook-ware	1		-	90	7 - 9

[†] Turn the dish halfway through the cooking time.

Warming up food using the microwave mode

You can use the microwave mode to warm up food or to defrost and warm up food in a single step.

Tips for warming up food using the microwave mode

- Use microwave-safe cookware with a lid.
- Turn or stir the food 2-3 times during warming.
- After warming up the food, leave it to rest for 1-2 minutes.
- The food transfers heat to the cookware. The cookware can become very hot.
- Make sure that you do the following when you are warming up baby food:
 - Place bottles on the wire rack without the teat or lid.
 - Shake or stir the baby food well after warming it up.
 - Always check the temperature of the baby food.
- Wipe the cooking compartment dry after using it to warm up food.

⚠ WARNING – Risk of scalding!

There is a possibility of delayed boiling when a liquid is heated. This means that the liquid reaches boiling temperature without the usual steam bubbles rising to the surface. Even if the container only vibrates a little, the hot liquid may suddenly boil over and spatter.

- ▶ Always place a spoon in the container when heating liquids. This will prevent delayed boiling.

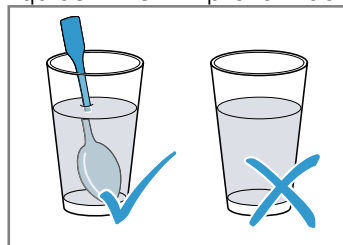

ATTENTION!

Metal touching the wall of the cooking compartment will cause sparks, which may damage the appliance or the inner door pane.

- ▶ Metal (e.g. a spoon in a glass) must be kept at least 2 cm from the cooking compartment walls and the inside of the door.

Recommended settings for warming up food using the microwave mode

Food	Accessory/cook-ware	Shelf position	Heating function → <i>Page 10</i>	Temperature in °C	Microwave power setting in W	Cooking time in mins
Drinks, warming up, 200 ml	Uncovered cookware	1		-	1000	1 - 3 ¹
Baby food, heating up, e.g. baby bottle, 150 ml	Uncovered cookware	1		-	360	1 - 3 ¹
Vegetables, chilled, 250 g	Covered cookware	1		-	600	3 - 8
Side dishes, e.g. pasta, dumplings, potatoes, rice Chilled	Covered cookware	1		-	600	5 - 10
Soup, stew, 400 ml Chilled	Covered cookware	1		-	600	5 - 7
Plated meal, 1 portion Chilled	Covered cookware	1		-	600	4 - 8
Bakes, 400 g, e.g. lasagne, potato gratin	Uncovered cookware	1		180 - 200	180	20 - 25
Side dishes, 500 g, e.g. pasta, dumplings, potatoes, rice Frozen	Covered cookware	1		-	600	7 - 10
Soup, stew, 200 ml Frozen	Covered cookware	1		-	600	4 - 6 ¹
Plated meal, 1 portion Frozen	Covered cookware	1		-	600	11 - 15

¹ Stir the food well.









28.8 Test dishes

The information in this section is provided for test institutes to facilitate testing of the appliance in accordance with EN 60350-1:2013 or IEC 60350-1:2011 and EN 60705:2012 or IEC 60705:2010.

Baking

- The setting values apply to food that is placed into a cold cooking compartment.
- Please take note of the information on preheating in the recommended settings tables. These setting values assume that the rapid heat-up function is not being used.
- For baking, use the lower of the specified temperatures to start with.
- Items that are placed in the appliance on baking trays or in baking tins/dishes at the same time will not necessarily be ready at the same time.
- Shelf positions when baking on 2 levels:
 - Universal pan: Shelf position 3
 - Baking tray: Shelf position 1
- Hot water sponge cake
 - When baking on two levels, place the springform tins at diagonally opposite corners of the wire racks.

Recommended settings for baking

Food	Accessory/cookware	Shelf position	Heating function → <i>Page 10</i>	Temperature in °C	Cooking time in mins
Viennese whirls	Baking tray	1		150–160 ¹	20–30
Viennese whirls	Baking tray	1		140–150 ¹	25–35
Small cakes	Baking tray	1		160 ¹	25–35
Small cakes	Baking tray	1		150 ¹	20–30
Small cakes	Baking tray	1		150 ¹	20–30
Small cakes, 2 levels	Universal pan + Baking tray	3+1		140 ¹	30–40
Hot water sponge cake	Springform cake tin, diameter 26 cm	1		160–170 ²	25–35
Hot water sponge cake	Springform cake tin, diameter 26 cm	1		160–170 ²	30–45

¹ Preheat the appliance for five minutes. Do not use the rapid heating function.

² Preheat the appliance. Do not use the rapid heating function.

Recommended settings for grilling

Food	Accessory/cookware	Shelf position	Heating function → <i>Page 10</i>	Temperature in °C/grill setting	Cooking time in mins
Toasting bread	Wire rack	3		3	2–6



Microwave cooking

- If you use the wire rack, slide it into the cooking compartment with the **Microwave** imprint facing the appliance door and the bump pointing downwards.
- To test the microwave mode on its own, switch off the drying function in the basic settings. → *Page 24*



Recommended settings for defrosting food using the microwave mode

Food	Accessories/cookware	Shelf position	Heating function → <i>Page 10</i>	Microwave power setting in W	Cooking time in mins
Meat	Uncovered cookware	1		1. 180 2. 90	1. 5 2. 10–15

Recommended settings for microwave cooking

Food	Accessories/cook-ware	Shelf position	Heating function → <i>Page 10</i>	Microwave power setting in W	Cooking time in mins
Egg wash	Uncovered cookware	1		1. 360 2. 180	1. 20 2. 20–25
Sponge	Uncovered cookware	1		600	7–9
Meat loaf	Uncovered cookware	1		600	22–27

Recommended settings for cooking in combination with the microwave mode

Food	Accessory/cook-ware	Shelf position	Heating function → <i>Page 10</i>	Temperature in °C	Microwave power setting in W	Cooking time in mins
Potato gratin	Uncovered cookware	1		150 - 170	360	25 - 30
Cakes	Uncovered cookware	1		190 - 210	180	12 - 18
Chicken	Uncovered cookware	1		180 - 200	360	25 - 35 ¹

¹ Turn the dish 2/3 of the way through the cooking time.

29 Installation instructions



Observe this information when installing the appliance.



29.1 General installation instructions

Follow these instructions before you start with the installation of the appliance.

- The installation cabinet must not have a back panel behind the appliance. There should be a gap of at least 35 mm between the wall and the cabinet base as well as the rear panel of the cabinet situated above.
- Ventilation slots and intake openings must not be covered.
- The safe operation of this appliance can only be guaranteed if it has been installed to a professional standard in accordance with these installation instructions. The installer shall be liable for damages incurred as a result of incorrect installation.
- Check the appliance for damage after unpacking it. Do not connect the appliance if it has been damaged in transit.

- Before starting up the appliance, remove any packaging material and adhesive film from the cooking compartment and the door.
- Proceed in accordance with the installation sheets for installing accessories.
- Fitted units must be heat-resistant up to 95 °C, and adjacent unit fronts up to 70 °C.
- Do not install the appliance behind a decorative door or the door of a kitchen unit. There is a risk of overheating.
- Cut-out work on the units should be carried out before installing the appliance. Remove any shavings. Otherwise, the correct operation of electrical components may be adversely affected.
- The mains socket for the appliance must either be located in the hatched area  or outside of the area where the appliance is installed. Any unsecured units must be secured to the wall using a standard bracket .

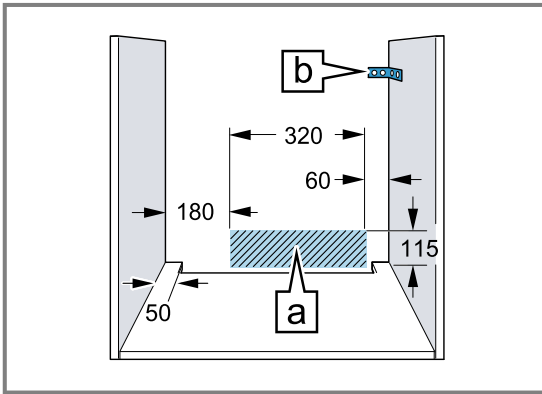

- Wear protective gloves so that you do not cut yourself. Parts that are accessible during installation may have sharp edges.
- Dimensions of the figures in mm.

⚠ WARNING – Risk of fire!

It is dangerous to use an extended power cord and non-approved adapters.

- ▶ Do not use multiple socket strips.
- ▶ Only use extension cables that are certified, have a minimum cross section of 1.5 mm² and comply with the applicable national safety requirements.
- ▶ If the power cord is too short, contact customer service.
- ▶ Only use adapters approved by the manufacturer.

ATTENTION!

Carrying the appliance by the door handle could break it. The door handle cannot support the weight of the appliance.

- ▶ Do not carry or hold the appliance by the door handle.

29.2 Appliance dimensions

You will find the dimensions of the appliance here

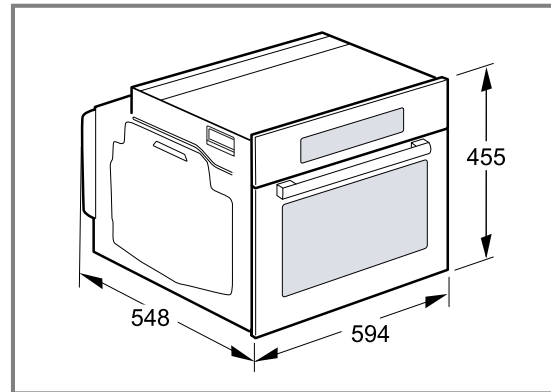

29.3 Installation below a worktop

Observe the installation dimensions and the installation instructions when installing below a worktop.

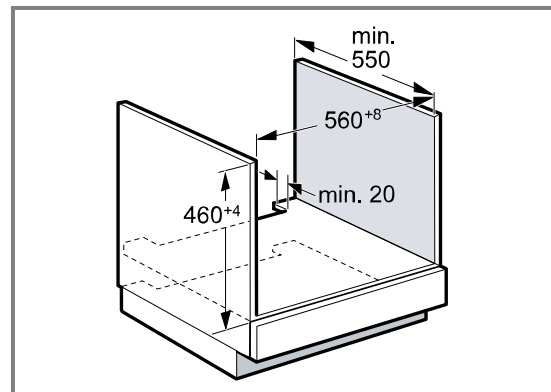

- To ventilate the appliance, the intermediate floor must have a ventilation cut-out.
- The worktop must be secured to the built-in unit.
- Observe any available installation instructions for the hob.

29.4 Installation underneath a hob

If the appliance is installed under a hob, the following minimum dimensions must be adhered to (including substructure, if applicable).

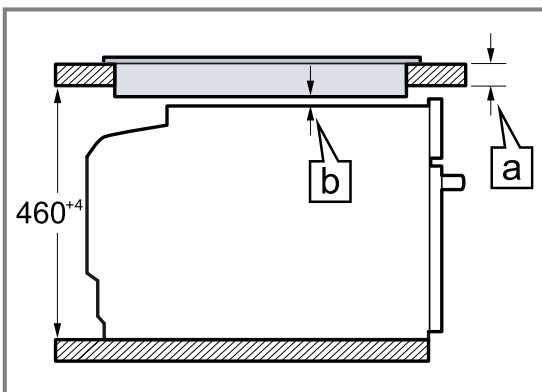

The minimum worktop thickness **[b]** a is based on the required minimum clearance **[a]**.

Hob type	a raised in mm	a flush in mm	b in mm
Induction hob	42	43	5
Full-surface induction hob	52	53	5
Gas hob	32	43	5
Electric hob	32	35	2

29.5 Installation in a tall unit

Observe the installation dimensions and the installation instructions when installing in a tall unit.

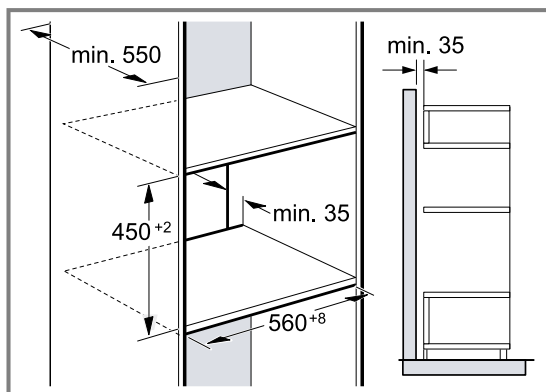

- To ventilate the appliance, the intermediate floors must have a ventilation cut-out.
- In order to ensure sufficient ventilation of the appliance, there must be a ventilation opening of at least 200 cm² in the base area. To do this, trim the base panel or fit a ventilation grille. Ensure that the air exchange is guaranteed in accordance with the diagram.

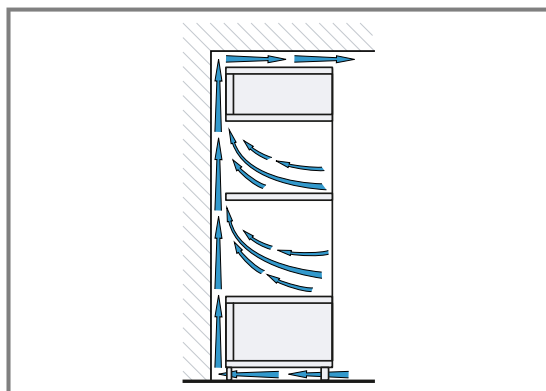

- If the tall unit has another back panel in addition to the element back panels, this must be removed.
- Only fit the appliance up to a height which allows accessories to be easily removed.

29.6 Corner installation

Observe the installation dimensions and the installation instructions when installing in a corner.

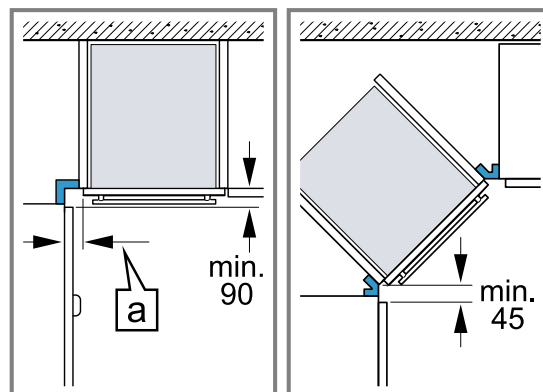

- To ensure that the appliance door can be opened, you must take the minimum dimensions into consideration when installing in a corner. The dimension \boxed{a} is dependent on the thickness of the unit front and the handle.

29.7 Electrical connection

In order to safely connect the appliance to the electrical system, follow these instructions.

- The appliance corresponds to protection class I and must only be operated with a protective earth connection.
- The fuse protection must correspond to the power rating specified on the appliance's rating plate and to local regulations.
- The appliance must be disconnected from the power supply whenever installation work is being carried out.
- The appliance must only be connected using the power cable provided.
- The power cable must be plugged in at the rear of the appliance until you hear a clicking sound. A 3 m power cable can be obtained from the after-sales service.
- The power cable must only be replaced with a cable from the original manufacturer. This is available from after-sales service.
- Contact protection must be ensured during the installation.

Electrically connect the appliance with the protective contact plug

Note: The appliance must only be connected to a protective contact socket that has been correctly installed.

- ▶ Insert the plug into the protective contact socket. When the appliance is installed, the mains plug of the power cord must be freely accessible. If free access to the mains plug is impossible, an all-pole

isolating switch must be integrated into the permanent electrical installation in accordance with the installation regulations.

Electrically connecting an appliance without a protective contact plug

Note: Only a licensed professional may connect the appliance. Damage caused by incorrect connection is not covered under the warranty.

An all-pole isolating switch must be integrated into the permanent electrical installation according to the installation regulations.

1. Identify the phase and neutral conductors in the socket.
The appliance may be damaged if it is not connected correctly.
2. Connect the hob in accordance with the connection diagram.
See the rating plate for the voltage.
3. Connect the wires of the mains power cable according to the colour coding:
 - Green/yellow = Protective conductor Ⓢ
 - Blue = Neutral conductor
 - Brown = Phase (external conductor)

29.8 Installing the appliance

1. Slide the appliance in fully and centre it.

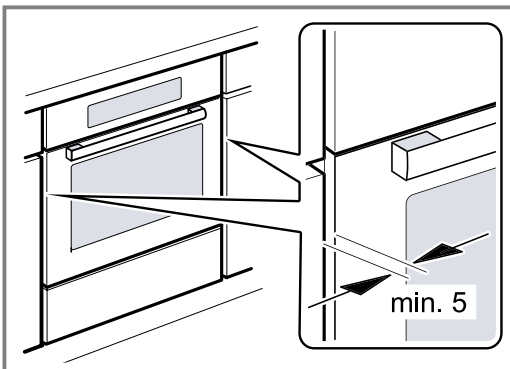

2. Screw the appliance into place.

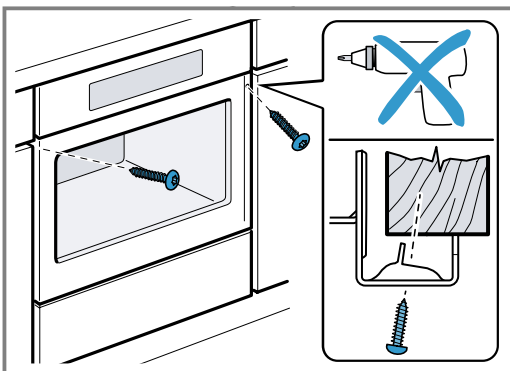

3. For handleless kitchens with vertical bar handle strips:
 - Attach a suitable filling piece ① in order to cover any sharp edges and to guarantee a safe installation.
 - Pre-drill aluminium profiles to establish a screw connection ②.
 - Secure the appliance using a suitable screw ③.

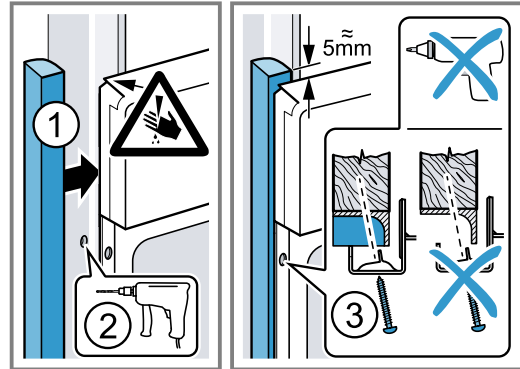

Note: The gap between the worktop and the appliance must not be closed by additional battens. Thermal insulation strips must not be fitted to the side panels of the surround unit.

29.9 Removing the appliance

1. Disconnect the appliance from the power supply.
2. Undo the fastening screws.
3. Lift the appliance slightly and pull it out completely.

BSH Hausgeräte GmbH

Carl-Wery-Straße 34

81739 München

GERMANY

www.siemens-home.bsh-group.com

Valid within Great Britain:
Imported to Great Britain by
BSH Home Appliances Ltd.
Grand Union House
Old Wolverton Road
Wolverton, Milton Keynes
MK12 5PT
United Kingdom

Manufactured by BSH Hausgeräte GmbH under the trademark licence of Siemens AG



9001620286 (010810)

en