

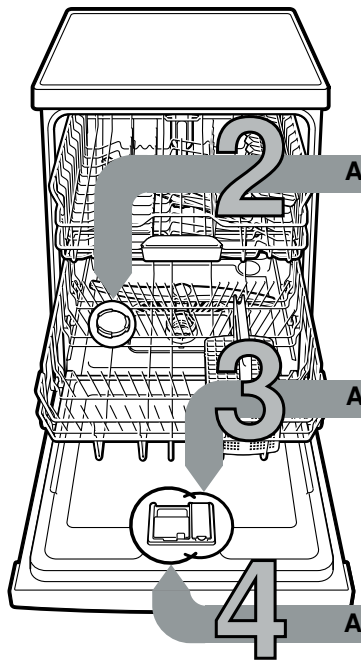

Brief and handy: everything your dishwasher needs...
Before using for the first time, read the operating instructions!

1



Add special salt

Dissolves limescale (not necessary when set to 0!) ...

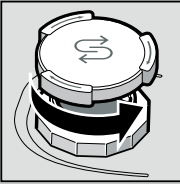

Open the lid.

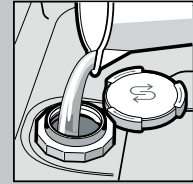

Only fill the salt dispenser with water before the first wash.

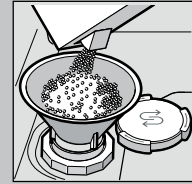

Add special salt (never use detergent!).

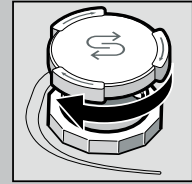

Close the lid. Rinse immediately.

Add rinse aid

Gets it sparkling clean ...

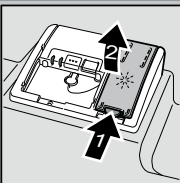

Press marking 1, lift lid 2.



For optimum drying results

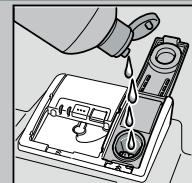

Add rinse aid.

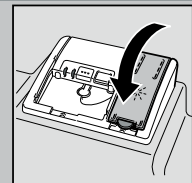

Close lid. CLICK!

Add detergent

A lot of dirt, a lot of detergent ...

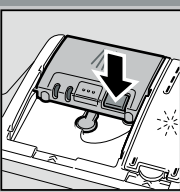

If required, open the cover (press button).

Attention: Combination products are not suitable for all programmes, follow manufacturer's instructions.

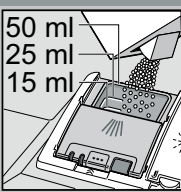
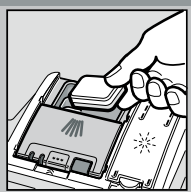

Pour detergent into the dry detergent dispenser only.

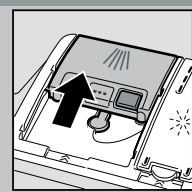

Slide cover shut, press. PLOP!

5 **Switch on the appliance**

6 **Select programme**

Quick, economical or intensive ...



7 **Start the programme Off we go...**

8 **Switch off the appliance Everything OK...**

Overview of programmes

This overview describes all the possible programmes. You can see which programmes your appliance offers from its control panel. The values given in the programme details are laboratory measurements compliant with European standard EN 60436. The consumption figures depend on the selected programme and additional functions. The programme duration will be different if the machine is short of rinse additive or the function is turned off.

* half normal load
 ** Suitable programme for running at night: it takes longer, but is extremely quiet.

	Intensive 70°	Auto 45°/65°	Eco 50°	Silence ** 50°	Speed 65°	Speed 60°	Speed 45°	Glass 40°	Favourite	Machine Care
Duration in hrs : mins.	2:05 - 2:15	1:40 - 2:45	4:55	4:00	1:00	1:29	0:29 *	1:40 - 1:45	0:15	2:10 - 2:15
Energy consumption in kWh	1,350 - 1,400	0,850 - 1,450	0,920	1,100	1,200	1,250	0,750	0,750 - 0,800	0,050	1,130 - 1,450
Water consumption in litres	10,5 - 13,5	7 - 15,5	9,5	10,5	10	11,5	10	11,5 - 14	4	13 - 15,2

You will find descriptions of possible additional functions in your instruction manual.

Adjusting the water softening system *

Ask your water supply company what the water hardness is and enter this...
 * Only before the first wash or if the water hardness has changed

Water-hardness-value °E	Hardness range	mmol/l	Setting value
0-8	Soft	0-1.1	4:00
9-10	Soft	1.2-1.4	4:01
11-12	Medium	1.5-1.8	4:02
13-15	Medium	1.9-2.1	4:03
16-20	Medium	2.2-2.9	4:04
21-26	Hard	3.0-3.7	4:05
27-38	Hard	3.8-5.4	4:06
39-62	Hard	5.5-8.9	4:07

Quickly done...

How to adjust

- Switch on the ON/OFF switch
 - Press **Setup 3 sec.** button for 3 seconds.
- The display shows **Hxx** and **Set**
- Press the Start button until the correct water hardness level is set.
 - To store the settings, press the < button for 3 seconds.



Maintenance and care

For perfect rinsing results ...

Cleaning waste water pump

Filters
... check, if required, clean.

Rotate filter cylinder, remove filter system ...



rinse under running water ...

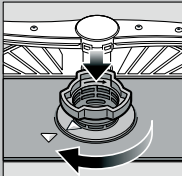

insert ...

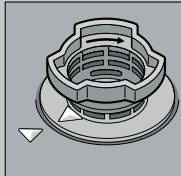

Screw on filter system
NOTE MARK!

- Pull out the mains plug.
- Remove filters and scoop out water.
- Lever off cover (A).
- Check area around the fan impeller for foreign objects.
- Click cover shut (B).
- Insert filters.

Spray arms
... Remove blockages/deposits.

pull lower arm upwards ...



unscrew upper arm ...



clean spray nozzles under running water (if required use toothpicks) ...

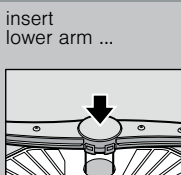

insert lower arm ...
screw on upper arm tightly

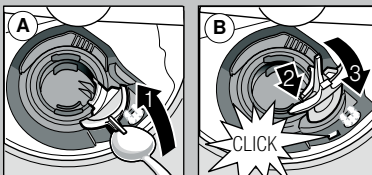

Rectify small faults yourself ...

... because self-help is worth it!

For more information see the instruction manual

Fault	Possible causes	Solution
Display E32 -00 and are lit	Supply fitting jammed or furred up Water supply not connected	<ul style="list-style-type: none"> ▶ Open supply fitting. ▶ 1. Unscrew water connection. ▶ 2. Clean filter in the water supply. ▶ 3. Flow rate must be min. 10 l/min when water supply is open. If the flow rate is less, replace the supply fitting. ▶ Install supply hose without kinks. ▶ Connect water supply. (Drinking water connection in the instruction manual).
Display E92 -40	Filters are soiled or blocked	▶ Clean the filters (see above).
Display E61 -03 and are lit	Waste water hose is blocked or kinked Cover of waste water pump not attached	<ul style="list-style-type: none"> ▶ Reposition the waste water hose without kinks. ▶ Attach cover (see above).
Display E61 -02 and are lit	Waste water pump blocked	▶ Clean waste water pump (see above).
Other error display Exx -xx is lit	Appliance technically defective	<ul style="list-style-type: none"> ▶ Call customer service (state the error displayed). ▶ Unplug the appliance. Turn off the tap.
Residual water in the appliance	Programme has not yet ended	▶ Close the appliance and switch it on or terminate the programme (see Terminating the programme).
Rust on cutlery	Cutlery not rust-resistant Hard knife blades are more susceptible Extraneous rust	<ul style="list-style-type: none"> ▶ Use dishwasher-safe cutlery. ▶ Never wash rusting parts in the appliance.

Fault	Possible causes	Solution
Tableware is not clean Sand or gritty residue on the tableware 	<ul style="list-style-type: none"> Items of tableware lying against or on top of each other Not enough detergent Unsuitable programme selected Spray arm nozzles blocked Filters are soiled, not securely positioned Spray arms blocked 	<ul style="list-style-type: none"> ▶ Separate tableware, prevent points of contact. ▶ Follow the manufacturer's instructions (detergent). ▶ Select a more intensive programme. ▶ Clean spray arms (see above). ▶ Clean the filters (see above). ▶ Arrange tableware so that spray arms can rotate freely.
Marks and streaks	Rinse aid dosage too high / too low	<ul style="list-style-type: none"> ▶ In the case of streaks: reduce detergent dosage. ▶ With water or limescale marks: increase dosage.
Tableware is not dry	Rinse aid The combined detergent used has poor drying performance. Appliance setting	<ul style="list-style-type: none"> ▶ Increase dosage. Change product. ▶ Use rinse aid. ▶ Activate intensive drying (depending on model)
Milky deposits on the tableware (removable)	Water softening function is wrongly configured; Insufficient special salt	<ul style="list-style-type: none"> ▶ Configure water softening system correctly. ▶ Add special salt.
Milky deposits, glasses clouded / opaque (cannot be removed)	Glasses not dishwasher-proof.	<ul style="list-style-type: none"> ▶ Use dishwasher-safe glasses. ▶ Use gentle detergents for glass.
Plastic / tableware items discoloured	Not enough detergent Discolouration by food colourings (tomato sauce)	<ul style="list-style-type: none"> ▶ Follow the manufacturer's instructions (detergent). ▶ Discolouration will not damage the appliance; It will fade after further wash cycles.

Cancel the programme ...

During the programme, press the button for approx. 4 sec. (reset).



All displays light up, then "0:01" appears in the display "0:00" appears after the programme has finished

Load the appliance correctly ...

Insert dishwasher-proof tableware (roughly remove large remnants of jam, dairy products and meals without leaving residue from ash, wax, lubricating grease, paint, adhesive labels) as described in the instruction manual and check that the spray arms can rotate freely