



Brief and handy: everything your dishwasher needs ...
Before using for the first time, read the Installation instructions and Operating instructions!

1

Adjusting the water softening system *

Ask your water supply company what the water hardness is and enter ...

Water hardness value Clarke	Hardness range	mmol/l	Factory setting
0-8	soft	0-1.1	H:00
9-10	soft	1.2-1.4	H:01
11-12	medium	1.5-1.8	H:02
13-15	medium	1.9-2.1	H:03
16-20	medium	2.2-2.9	H:04
21-26	hard	3.0-3.7	H:05
27-38	hard	3.8-5.4	H:06
39-62	hard	5.5-8.9	H:07

* only before the first wash or if the water hardness has been changed

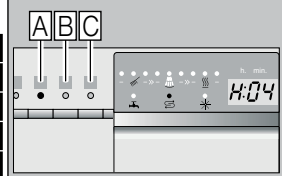

Quickly sorted ...

How to adjust

- Switch on ON/OFF switch.
- Hold down programme button A and press START button until H:0... is indicated on the digital display.
- Release both buttons. The LED for button A flashes and the factory set value of H:04 is indicated on the digital display.
- Press programme button C. Each time the button is pressed the set value increases by one setting; when the value reaches H:07, the display jumps back to H:00 (off).
- Press START button. The chosen setting has now been stored.

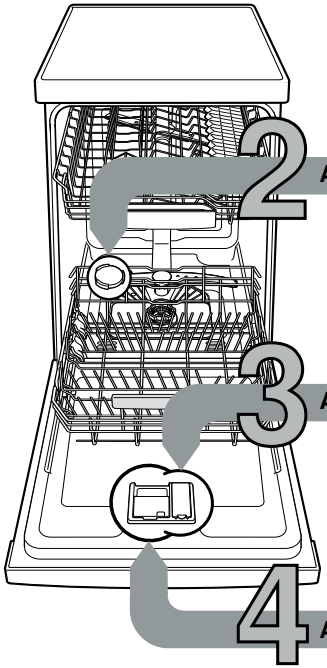

Add special salt

Dissolves limescale (not necessary when set to 0!) ...

For optimal washing results



Open the lid.



Only fill the salt dispenser with water before the first wash.



Add special salt (never use detergent!).



Close the lid. Rinse immediately.

Add rinse aid

Gets it sparkling clean ...

For optimum drying results



Press marking 1, lift lid 2.



Add rinse aid.



Close lid. CLICK!

Add detergent

A lot of dirt, a lot of detergent ...



If required, open the cover (press button).

Attention: Combination products are not suitable for all programmes, follow manufacturer's instructions.



Pour detergent into the dry detergent dispenser only.



Slide cover shut, press. PLOP!

5 Switching on the appliance

6 Select programme

Quick, economical or intensive ...

Overview of programmes

This overview describes all the possible programmes. You can see which programmes your appliance offers from its control panel. The values given in the programme details are laboratory measurements compliant with European standard EN 60436. The consumption figures depend on the selected programme and additional functions. The programme duration will be different if the machine is short of rinse additive or the function is turned off.

* half normal load
 ** Suitable programme for running at night: it takes longer, but is extremely quiet.

	Intensive 70°	Auto 45°/65°	Eco 50°	Silence ** 50°	Glass 40°	65°	Quick 65°	Quick 45°	Pre Rinse	Machine Care
Duration in hrs : mins.	2:05-2:15	1:30-2:30	3:15	3:55-4:00	1:25-1:30	1:00	1:00	0:29 *	0:15	1:30
Energy consumption in kWh	1,200-1,300	0,700-1,300	0,755	0,780-0,800	0,750-0,800	1,000	1,000	0,700	0,050	0,800-0,950
Water consumption in litres	11-14	7-16	9,5	9	11-13	10	10	9	4	9,5-12

7 Start programme Here we go ...

8 Switch off the appliance Everything o.k. ...

You will find descriptions of possible additional functions in your instruction manual.

Maintenance and care

For perfect rinsing results ...

Cleaning waste water pump

Filters
... check, if required, clean.

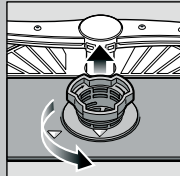

Rotate filter cylinder, remove filter system ...

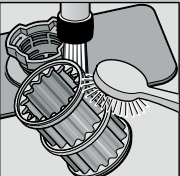

rinse under running water ...

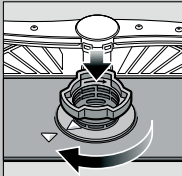

insert ...

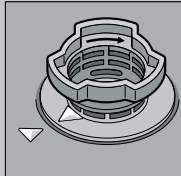

screw on filter system. NOTE MARK!

- Pull out the mains plug.
- Remove filters and scoop out water.
- Lever off cover (A).
- Check area around the fan impeller for foreign objects.
- Click cover shut (B).
- Insert filters.

Spray arms
... remove blockages/deposits.

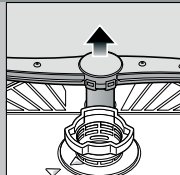

Pull lower arm upwards ...

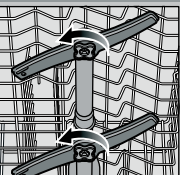

unscrew upper spray arms ...

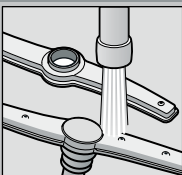

clean spray nozzles under running water (if required use toothpicks) ...

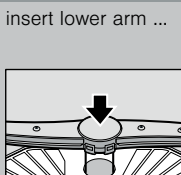

insert lower arm ...
screw on upper spray arms tightly.

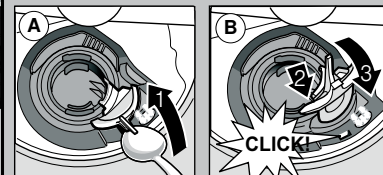

Rectifying minor faults yourself ...

... as it is worth doing it yourself!

More information can be found in the operating instructions

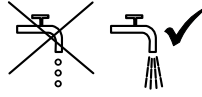
Fault	Possible causes	Remedial action
Display "A" is lit	Supply fitting jammed or calcified 	<ul style="list-style-type: none"> ▶ Open supply fitting. ▶ 1. Unscrew water connection. ▶ 2. Clean filter in the water connection. ▶ 3. Flow rate must be min. 10 l/min., when water supply is open. If the flow rate is less, replace the supply fitting. ▶ Install supply hose without kinks.
Display "E:22"	Filters are soiled or blocked	<ul style="list-style-type: none"> ▶ Clean the filters (see above).
Display "E:24" and "A" are lit	Waste water hose is blocked or kinked Cover not attached to waste water pump	<ul style="list-style-type: none"> ▶ Install waste water hose without kinks. ▶ Attach cover (see above).
Display "E:25" and "A" are lit	Waste water pump blocked	<ul style="list-style-type: none"> ▶ Clean waste-water pump (see above).
Other fault display "E:XX" is lit	Appliance has technical defect	<ul style="list-style-type: none"> ▶ Call factory customer service (state fault display). ▶ Unplug appliance.
Residual water in the appliance	The programme has not yet ended	<ul style="list-style-type: none"> ▶ Close the appliance and switch it on or terminate the programme (see Terminating the programme).
Rust on the cutlery	Cutlery not rust-resistant Hard knife blades are more susceptible Extraneous rust	<ul style="list-style-type: none"> ▶ Use dishwasher-proof cutlery. ▶ Never wash rusting parts in the appliance.

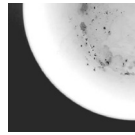
Fault	Possible causes	Remedial action
Utensils are not clean	Utensils are situated close together or one above the other	<ul style="list-style-type: none"> ▶ Separate the utensils, prevent contact points.
Sand or gritty residue on the utensils 	Too little detergent Unsuitable programme selected Spray arm nozzles blocked Filters dirty, not seated firmly Spray arms blocked	<ul style="list-style-type: none"> ▶ Follow manufacturer's instructions (detergent). ▶ Select a more intensive programme. ▶ Clean the spray arms (see above). ▶ Clean the filters (see above). ▶ Arrange the utensils so that the spray arms can rotate freely.
Stains and streaks	Rinse aid dosage too high/too low	<ul style="list-style-type: none"> ▶ Streaks: reduce dosage. ▶ Water or limescale stains: increase dosage.
Utensils not dry	Rinse aid The combined detergent used has a poor drying performance Appliance setting	<ul style="list-style-type: none"> ▶ Increase dosage. ▶ Change the product. ▶ Use rinse aid. ▶ Activate intensive drying (depending on model).
Milky deposits on the utensils (can be removed)	Water softening system incorrectly set No salt	<ul style="list-style-type: none"> ▶ Correctly set water softening system. ▶ Refill with special salt.
Milky deposits, glasses cloudy/tarnished (cannot be removed)	Glasses not dishwasher-proof	<ul style="list-style-type: none"> ▶ Use dishwasher-proof glasses.
		<ul style="list-style-type: none"> ▶ Use a detergent suitable for glasses.
Plastic/utensils discoloured	Too little detergent Discoloration caused by food colourings (tomato sauce)	<ul style="list-style-type: none"> ▶ Follow manufacturer's instructions (detergent). ▶ Discoloration is harmless; subsequent rinse cycles will cause it to fade.

Terminating the programme ...

Loading the dishwasher correctly ...

While the programme is running, press the START button for approx. 3 sec. (Reset).



The numerical display indicates "0:01"; approx. 1 minute after the programme ends, "0:00" is indicated.



Switch off the appliance.

Dishwasher-proof utensils (not soiled with ash, wax, lubricating grease, ink or adhesive labels; remove large remnants of jam, milk products and food according to the operating instructions and check that the spray arms can rotate freely).