



SIEMENS



# Tumble dryer

WT46G40SZA

[siemens-home.bsh-group.com/welcome](https://siemens-home.bsh-group.com/welcome)

en Installation and operating instructions

Register  
your  
product  
online

## Your new tumble dryer

You have opted for a tumble dryer manufactured by Siemens.

Please take a few minutes to read and become familiar with the advantages of your tumble dryer.

To meet the high quality demands required by Siemens, every tumble dryer that leaves our factory is carefully checked to ensure that it functions correctly and is in perfect condition.

For more information on our products, accessories, replacement parts and services, see our website [www.siemens-home.bsh-group.com](http://www.siemens-home.bsh-group.com) or contact our Customer Service centres.

If the operating and installation instructions describe different models, any differences will be pointed out at the relevant points in the text.



Read these operating and installation instructions before operating the tumble dryer.

## Display rules

### **Warning!**

This combination of symbol and signal word indicates a possibly dangerous situation. Not heeding the warning can cause death or injuries.

### **Caution!**

This signal word indicates a possibly dangerous situation. Not heeding the caution can cause property and/or environmental damage.

### **Note/tip**

Information about the optimum use of the appliance/any other useful information.

### **1. 2. 3. / a) b) c)**

The steps are represented by numbers or letters.

■ / -

Lists are represented by a small box or a dash.

# Contents

## **Intended use** ..... 4

## **Safety instructions** ..... 4

Children/people/pets	4
Installation	6
Operation	8
Cleaning/Maintenance	10

## **Environmental protection** .... 12

Packaging/old appliance	12
Energy-saving tips	12

## **Installation and connection** ... 13

Scope of delivery	13
Installing and connecting the dryer	13
Optional accessories	14
Transport and frost protection	14

## **Draining the condensation water** ..... 15

## **The main points in brief** ..... 17

## **Getting to know your appliance** ..... 18

Dryer	18
Control panel	19
Display panel	20

## **Laundry** ..... 21

Preparing the laundry	21
Sorting washing according to:	21

## **Programmes and buttons** .... 22

Programmes	22
Buttons	24

## **Operating the appliance** ..... 25

Loading laundry and switching on the dryer	25
Setting a programme	25
Starting the programme	25
Programme sequence	25
Changing the programme or adding laundry	26
Cancelling the programme	26
Programme end	26
Removing laundry and switching off the dryer	26
Clean the fluff filter	27
Emptying the condensate container	28

## **Setting the signal and current** ..... 29

## **Cleaning** ..... 30

Cleaning the dryer and the control panel	30
Cleaning the heat exchanger	30
Cleaning the moisture sensor	32

## **Faults and what to do about them** ..... 33

## **After-sales service** ..... 35

## **Consumption values** ..... 36

## **Technical data** ..... 37



## Intended use

- This appliance is intended for private domestic use only.
- Do not install or operate this appliance anywhere that is liable to experience frost and/or outdoor conditions. There is a risk that the appliance will be damaged if residual water in it freezes. If hoses freeze up, they may crack/burst.
- This appliance must only be used for drying and freshening up domestic laundry, consisting of items that have been washed with water and are suitable for tumble drying (see label on item). Using the appliance for any other purpose is outside of the scope of its intended application and is forbidden.
- This appliance is intended for use up to a maximum height of 4000 metres above sea level.

### Before you switch on the appliance:

Check that there is no visible damage to the appliance. Do not operate the appliance if it is damaged. Should you have any problems, please contact your specialist dealer or our customer service.

Read and follow the operating and installation instructions and all other information provided with this appliance.

Retain the documents for subsequent use or for subsequent owners.



## Safety instructions

The following safety information and warnings are provided to protect you from injury and to prevent material damage to your surroundings.

It is nevertheless important to take the necessary precautions and to proceed with care when installing, maintaining, cleaning and operating the appliance.

### Children/people/pets



#### Warning Risk of death!

Children and other people who are unable to assess the risks involved when using the appliance may injure themselves or may find themselves in life-threatening situations. Therefore please note:

- The appliance may be used by children over the age of 8 years and by persons with reduced physical, sensory or mental capacity or by persons with a lack of experience or knowledge as long as they are supervised or have received instruction on how to use the appliance safely and they have understood the potential risks of using the appliance.
- Children must not play with this appliance.

- Do not allow children to clean or maintain this appliance unsupervised.
- Keep children under 3 years and pets away from this appliance.
- Do not leave the appliance unattended when children or other people who are unable to assess the risks are in the vicinity.

**⚠ Warning**  
**Risk of death!**

Children may lock themselves inside appliances and find themselves in a life-threatening situation.

- Do not position the appliance behind a door, as this may obstruct the appliance door or prevent it from opening completely.
- Once an appliance has reached the end of its life, pull the mains plug from the socket **before** severing the mains cable, and then destroy the lock on the appliance door.

**⚠ Warning**  
**Risk of suffocation!**

If allowed to play with the packaging/plastic film or packing components, children may become caught in these or pull them over their heads and suffocate.

Keep packaging, plastic film and packing components away from children.

**⚠ Warning**  
**Risk of poisoning!**

Detergents and care products may result in poisoning if consumed.

If accidentally swallowed, seek medical advice. Keep detergents and care products out of the reach of children.

**⚠ Warning**  
**Eye/skin irritation!**

Contact with detergents or care products may cause eye/skin irritation.

Rinse eyes/skin thoroughly if they/it come(s) into contact with detergents or care products. Keep detergents and care products out of the reach of children.

## Installation

### **Warning**

#### **Risk of electric shock/fire/ material damage/damage to the appliance!**

If the appliance is not installed properly, this may lead to a dangerous situation. Ensure the following:

- The mains voltage on your power socket must match the rated voltage specified on the appliance (identification plate). The connected loads and the required fuse protection are specified on the identification plate.
- The appliance must not be supplied through an external switching device, such as a timer, or connected to a circuit that is regularly switched on and off by a utility.
- The mains plug and the protective contact socket must match and the earthing system must be correctly installed.
- The installation must have an adequate cross section.

- The mains plug must be freely accessible at all times. If this is not possible, in order to comply with the relevant safety regulations, a switch (all pole disconnection) must be built into the permanent installation in accordance with electrical installation regulations.
- If using a residual current circuit breaker, only use one that bears the following mark: . The presence of this mark is the only way to be sure that it fulfils all the applicable regulations.

### **Warning**

#### **Risk of electric shock/fire/ material damage/damage to the appliance!**

If the appliance's mains cable is altered or damaged, this may result in electric shock, short circuiting or fire due to overheating.

The mains cable must not be kinked, crushed or altered, and must not come into contact with any heat sources.

**⚠ Warning****Risk of fire/material damage/  
damage to the appliance!**

The use of extension cords or power strips may result in fire due to overheating or short circuiting.

Connect the appliance directly to an earthed socket that has been correctly installed. Do not use extension cords, power strips or multi-way couplers.

**⚠ Warning****Risk of injury/material  
damage/damage to the  
appliance!**

- The appliance may vibrate or move when in operation, potentially resulting in injury or material damage.  
Place the appliance on a clean, even, solid surface and, using a spirit level to guide you, level it with the screw-in feet.

- Incorrectly placing (stacking) this appliance on top of a washing machine may result in injury, material damage and/or damage to the appliance.  
If this appliance is to be placed on top of a washing machine, the washing machine must be of at least the same depth and width as the appliance, and it must be secured in place with the appropriate connection set if available. → *Page 14*  
The appliance **MUST** be secured with this connection set. Stacking the appliance in any other way is forbidden.
- If you take hold of any of the appliance's protruding parts (e.g. the appliance door) in order to lift or move it, these parts may break off and cause injury.  
Do not take hold of any of the appliance's protruding parts in order to move the appliance.

## **Warning**

### **Risk of injury!**

- The appliance is very heavy. Lifting it may result in injury. Do not lift the appliance on your own.
- The appliance has sharp edges on which you could cut your hands. Do not take hold of the appliance by its sharp edges. Wear protective gloves to lift it.
- If the hoses and mains cables are not correctly routed, they may constitute a tripping hazard, which may result in injury. Route hoses and cables such that they do not constitute a tripping hazard.

## **Operation**

## **Warning**

### **Risk of explosions/fire!**

Laundry that has come into contact with solvents, oil, wax, wax remover, paint, grease or stain remover may ignite when dried in the machine, or even cause the appliance to explode. Therefore please note:

- Rinse the laundry thoroughly with warm water and detergent before drying it in the machine.
- Do not place laundry in this appliance to be dried if the laundry has not been washed first.

- Do not use the appliance if industrial chemicals have been used to clean the laundry.

## **Warning**

### **Risk of explosions/fire!**

- If there is any residual material left in the fluff filter, this may ignite when drying is in progress, or even cause the appliance to catch fire or explode. Clean the fluff filter regularly.
- Certain objects may ignite when drying is in progress, or even cause the appliance to catch fire or explode. Remove any lighters or matches from pockets on items of clothing.
- If there is coal dust or flour in the air around the appliance, this may cause an explosion. Make sure that the area around the appliance is kept clean when it is in operation.

## **Warning**

### **Risk of fire/material damage/damage to the appliance!**

If a program is terminated before the drying cycle has finished, this prevents the laundry from cooling down sufficiently and may cause the laundry to ignite, or may result in material damage or damage to the appliance.



- During the last part of the drying cycle, the laundry in the drum is not heated (cooling cycle). This is to ensure that it remains at a temperature at which it will not be damaged.
- Do not switch off the appliance before the drying cycle has finished unless you remove all items of laundry from the drum immediately and spread them out (to dissipate the heat).

**⚠ Warning**

**Risk of poisoning/material damage!**

Condensation water is not suitable for drinking and may be contaminated with lint. Contaminated condensation water may be hazardous to health and may cause material damage. Do not drink or reuse.

**⚠ Warning**

**Risk of poisoning!**

Poisonous fumes may be given off by cleaning agents that contain solvents, e.g. cleaning solvent. Do not use cleaning agents that contain solvents.

**⚠ Warning**

**Risk of injury!**

- If you support your weight/sit on the appliance door when it is open, the appliance may tip over, which may result in injury. Do not support your weight on the appliance door when it is open.
- If you climb onto the appliance, the worktop may break, which may result in injury. Do not climb onto the appliance.
- If you reach into the drum while it is still rotating, you risk injuring your hands. Wait until the drum has stopped rotating.

**⚠ Warning**

**Risk of burns!**

The exterior of the appliance's rear panel becomes very hot during operation. Never touch the surface of the appliance's rear panel when it is hot, and keep children away.



## Caution!

### Material damage/damage to the appliance

- If the amount of laundry in the appliance exceeds its maximum load capacity, it may not be able to operate properly, or this may result in material damage or damage to the appliance.  
Do not exceed the maximum load capacity of dry laundry. Make sure you comply with the maximum load capacities specified for each of the programs. → *Page 22*
- If you operate the appliance without a fluff catcher (e.g. fluff filter, fluff depot, depending on appliance specifications), or if the fluff catcher is incomplete or defective, this may result in damage to the appliance.  
Do not operate the appliance without a fluff catcher, or with a fluff catcher that is incomplete or defective.
- Light objects such as hair and lint may be sucked into the air inlet when the appliance is in operation. Keep these away from the appliance.
- Foam and foam rubber may deform or melt if dried in the appliance.  
Do not dry laundry items that contain foam or foam rubber in the appliance.

- If you pour the wrong quantity of detergent or cleaning agent into the appliance, this may result in material damage or damage to the appliance.  
Use detergents/care products/cleaning agents and softeners in accordance with the manufacturers' instructions.
- If the appliance overheats, it may not be able to operate properly, or this may result in material damage or damage to the appliance.  
Make sure that the appliance's air inlet is never obstructed when the appliance is in operation, and that the area around the appliance is adequately ventilated.

## Cleaning/Maintenance

### **Warning** **Risk of death!**

The appliance is powered by electricity. There is a risk of electric shock if you come into contact with live components. Therefore please note:

- Switch off the appliance. Disconnect the appliance from the power supply (pull out the plug).
- Never take hold of the mains plug with wet hands.

- When removing the mains plug from the socket, always take hold of the plug itself and never the mains cable, otherwise this may damage the mains cable.
- Do not make any technical modifications to the appliance or its features.
- Repairs and any other work on the appliance must only be conducted by our customer service or by an electrician. The same applies for replacing the mains cable (when necessary).
- Spare mains cables can be ordered from our customer service.

### **Warning**

#### **Risk of poisoning!**

Poisonous fumes may be given off by cleaning agents that contain solvents, e.g. cleaning solvent.

Do not use cleaning agents that contain solvents.

### **Warning**

#### **Risk of electric shock/material damage/damage to the appliance!**

If moisture penetrates the appliance, this may cause it to short circuit.

Do not use a pressure washer, steam cleaner, hose or spray gun to clean your appliance.

### **Warning**

#### **Risk of injury/material damage/damage to the appliance!**

The use of spare parts and accessories supplied by other brands is dangerous and may result in injury, material damage or damage to the appliance.

For safety reasons, use genuine spare parts and accessories only.

### **Caution!**

#### **Material damage/damage to the appliance**

Cleaning agents and agents for pretreating laundry (e.g. stain removers, prewash sprays, etc.) may cause damage if they come into contact with the surfaces of the appliance.

Therefore please note:

- Do not allow these agents to come into contact with the surfaces of the appliance.
- Clean the appliance with nothing but water and a soft, damp cloth.
- Remove any detergent, spray or other residues immediately.



## Environmental protection

### Packaging/old appliance



Dispose of packaging in an environmentally-responsible manner.

This appliance is labelled in accordance with European Directive 2012/19/EU concerning used electrical and electronic appliances (waste electrical and electronic equipment - WEEE).

The guideline determines the framework for the return and recycling of used appliances as applicable throughout the EU.

### Energy-saving tips

- Spin the laundry before drying. The drier the laundry, the shorter the drying time will be, thus consuming less energy.
- Load the dryer with the maximum load.  
**Note:** Do not exceed the maximum load for the programs, as this prolongs the drying time and increases energy consumption.
- Ventilate the room and keep the air inlet on the dryer free to ensure air exchange.
- Clean the fluff filter after each drying cycle. If the fluff filter is dirty, the drying time is prolonged and energy consumption is increased.
- **Energy saving mode:** If the dryer is not operated for a prolonged period, it automatically switches off before the program starts and when the program has ended to save energy. The display panel and indicator lamps go off after a few minutes and the Start button flashes. To activate the lighting, press any button, open or close the dryer door or turn the program selector.



## Installation and connection

### Scope of delivery

- Dryer
- Installation and operating instructions
- Basket for woollens\*
- Condensation drain\*

### Installing and connecting the dryer



#### **Warning** **Risk of death!**

There is a risk of electric shock as the dryer is operated with electricity.

- Check the dryer for visible damage. You must not operate the dryer if it is damaged.
- Before connecting the dryer to the power supply, ensure that the electric voltage specified on the rating plate matches the voltage of your socket.
- Only use residual current circuit breakers with the following symbol:  

- Ensure that the mains cable is not kinked or trapped and that it does not come into contact with heat sources or sharp edges.



#### **Warning** **Children could lock themselves in the dryer, putting their lives at risk!**

Do not set up the dryer behind a door or sliding door as this may obstruct the dryer door or prevent it from opening.

#### **Caution!** **Risk of injury**

- As the dryer is heavy, you could injure yourself by trying to lift it. Do not lift the dryer on your own.

\* Depending on the model

- You could cut your hands on the sharp edges of the dryer. Do not hold the dryer by the sharp edges.
- Protruding parts on the dryer may break off when it is lifted or pushed. Do not move the dryer by holding on to protruding parts.

#### **Caution!**

#### **Risk of material damage to the dryer or fabrics**

- Check the dryer for damage caused during transportation. Never operate a dryer if it is damaged.
- Any residual water in the dryer may freeze and damage the dryer. Do not install the dryer in rooms that are at risk of frost.

During installation ensure that:

- The dryer is placed on a clean, level and firm surface,
- The mains plug can be accessed at all times,
- The air inlet on the dryer is kept clear and there is sufficient ventilation,
- The area around the dryer is kept clean and
- The dryer is levelled using the threaded feet.

**Note:** Check the alignment of the appliance with a spirit level and correct if necessary. Change the height by turning the appliance feet. All appliance feet must stand firmly on the ground.

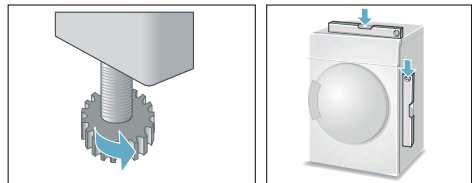

Incorrect alignment may cause high noise levels, vibrations and improper movement of the drum.

**Note:** If in doubt, have the appliance connected by a specialist.

## Optional accessories

Order optional accessories\* from the after-sales service:

### ■ **Washer-dryer stack connection set:**

To save space, the dryer can be placed on top of a suitable washing machine of the same width and depth.

The dryer must be fastened to the washing machine using this connection set.

Order number with pull-out worktop:

—;

Order number without pull-out worktop: **WZ11330**.

### ■ **Platform:**

For easier loading and unloading, raise your dryer with a platform. Transport laundry with the clothes basket integrated into the platform drawer.

Order number: **WZ20540G**.

### ■ **Basket for woollens:**

Dry individual woollen items, sports shoes and soft toys in the basket for woollens.

Order number: **WZ20600**.

### ■ **Connecting kit for the condensation drain:**

Use a hose to draw off the condensation immediately.

Order number: **WZ20160**.

## Transport and frost protection

### **To empty the condensate container:**

1. Use the programme selector to select any programme.
2. Press the Start button.
3. Wait for 5 minutes.  
**Note:** The condensation is drained.
4. Empty the condensate container again.
5. Switch off the dryer.

### **Caution!**

**Any residual water may leak out and cause material damage.**

Transport the dryer in an upright position.

\* Depending on the model

## Draining the condensation water

Condensation will form in the appliance as it dries the laundry.

You must ensure that the drain hose is connected when you operate the appliance.

If there is no drain hose connected to the appliance, the condensation water from the appliance will run into the condensation container. In this case, you will need to empty the condensation container each time the dryer finishes drying the laundry, and also if it becomes full before drying is complete.

Connect the drain hose as follows:

1. Remove the accessories from the dryer drum.

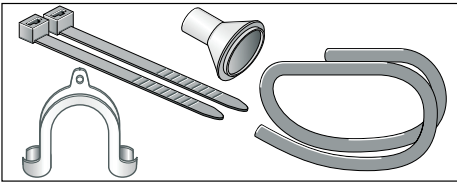

2. When the dryer is delivered from the factory, the hose for discharging the condensation into the condensation container is fastened to the connecting piece.
3. Detach the condensation hose from the socket.

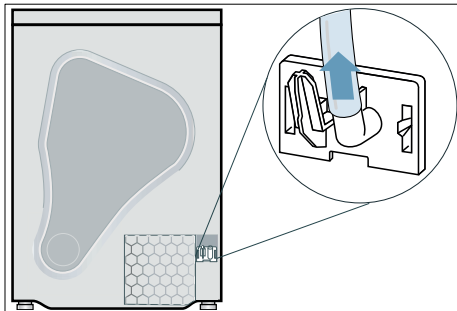

4. Place the condensation hose in the "parked" position.

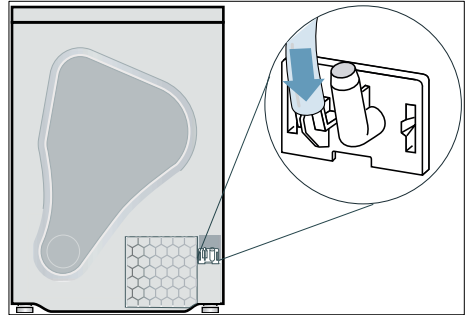

5. Take the drain hose from the accessories and secure it to the free connecting piece.

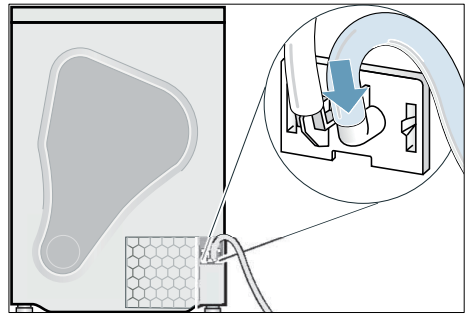

**en** Draining the condensation water

6. Fasten the other end of the drain hose with the remaining accessories, depending on the connection situation (A, B or C).

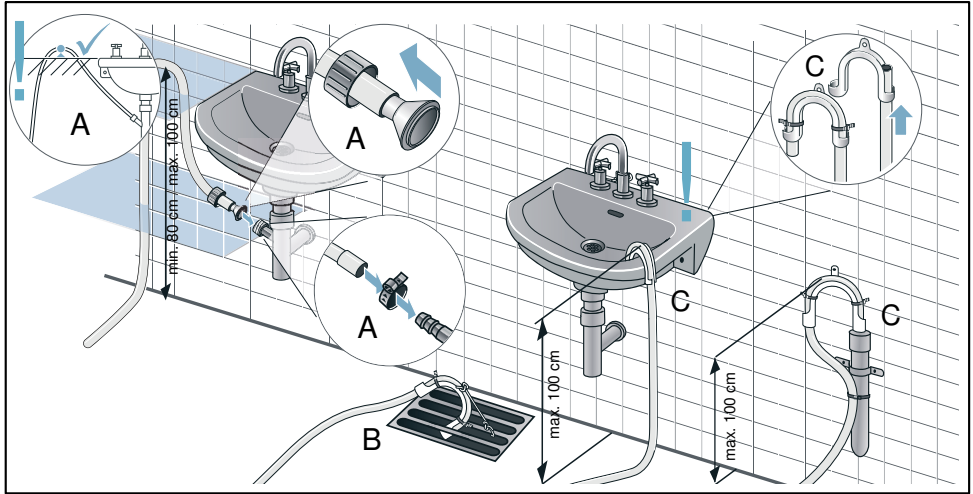

**Caution!**

**Accumulated water can be drawn back into the dryer and may cause material damage.**

Check that the water drains away from the wash basin quickly. The drain must not be sealed or blocked.

**Caution!**

**Material damage due to leaks or draining water.**

Secure the drain hose so that it cannot slip out. Do not kink the drain hose.

Ensure that a height difference of max. 100 cm and min. 80 cm between the installation surface and the drain is maintained for drainage into a siphon.



The condensation water is now discharged via the drain hose into the waste-water system or into a washbasin.

**Note:**

If you want to drain the condensation water back into the condensation container, reverse these steps.

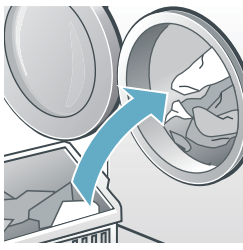
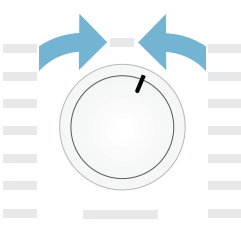
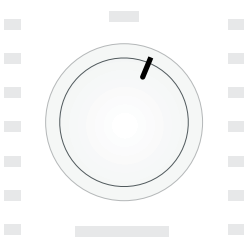
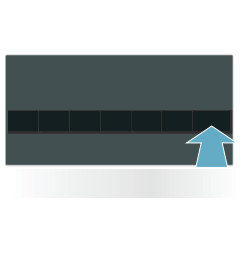

## The main points in brief

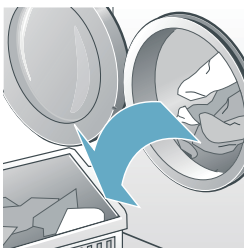
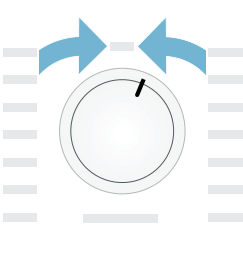
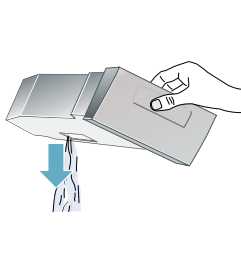
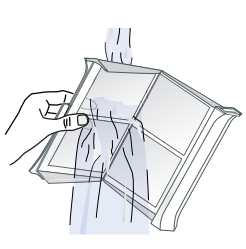
<b>1</b>		➔		➔	
	Load the laundry and close the door.		Switch on the dryer.		Select a programme and, if necessary, adjust the programme default settings.
<b>2</b>		➔		➔	
	Select the start button ►►.		Dry.		Unload the laundry.
<b>3</b>		➔		➔	
	Switch off the dryer.		Empty the condensate container.		Clean the fluff filter.

## Getting to know your appliance

### Dryer

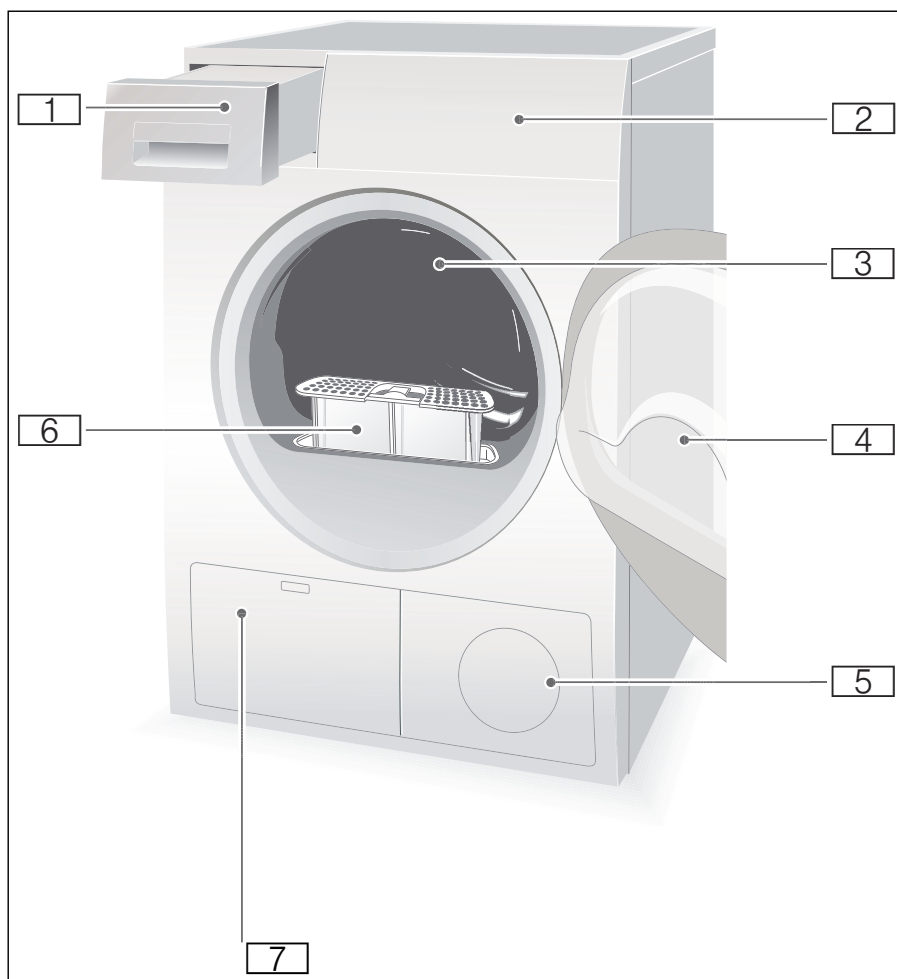

- 1** Condensate container
- 2** Control and display panel
- 3** Drum interior light (depending on the model)
- 4** Dryer door
- 5** Air inlet
- 6** Fluff filter
- 7** Heat exchanger

## Control panel

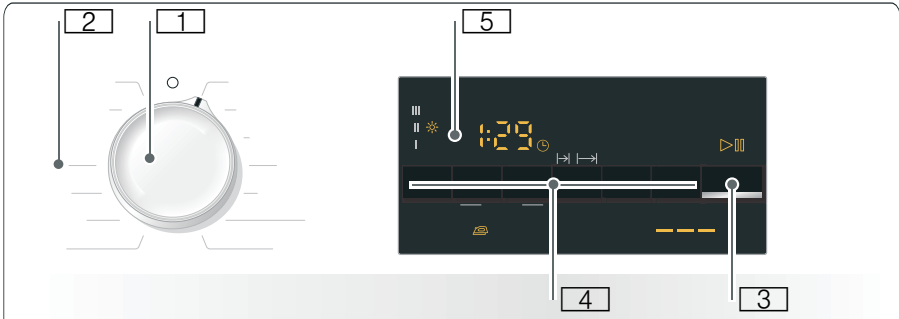

- 1 Use the **programme selector** to switch the dryer on and off and to select the programme.
- 2 **Programmes** → *Page 22.*
- 3 **Start button** for starting or interrupting the programme → *Page 24.*
- 4 **Buttons** → *Page 24.*
- 5 **Display panel with buttons** → *Page 20.*

## Display panel

### Buttons in the display panel

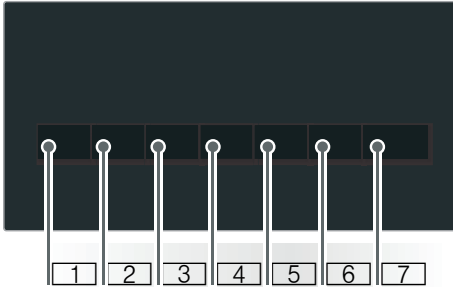

- 1 Select the **degree of dryness**.
- 2 Select the **drying time**.
- 3 Select the **Ready in time**.
- 4 Select **Anti-Crease**.
- 5 Select **Low-Heat Drying**.
- 6 Switch the **signal** on or off.
- 7 Select **Start/Pause**.

For a detailed description of all buttons, see → Page 24 onwards.

### Display panel

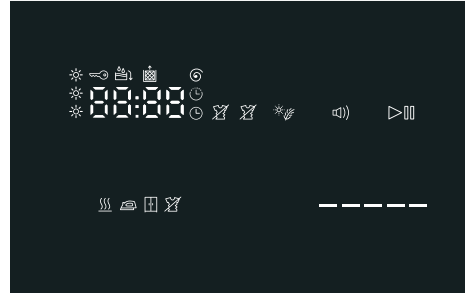

- "Anti-Crease" selected.
- Fine adjustment of the dryness level.
- Time programme selected.
- "Ready in" time selected.
- Childproof lock selected.
- Spin speed selected.
- Low-Heat Drying selected.
- Audible signal active.
- Start or Pause selected.
- 3 h** Programme delay in hours when "Ready in" time is selected.
- 1:27** Expected programme duration in hours and minutes.
- End - P -**  
Programme progress: Dry; Iron Dry; Cupboard Dry; Anti-Crease; End and Pause.
- Empties the condensate container; → Page 28.
- Cleans the fluff filters; → Page 27.



## Laundry

### Preparing the laundry

#### **Warning**

##### **Risk of explosion/fire!**

Remove any cigarette lighters and matches from pockets.

#### **Caution!**

##### **The dryer drum and fabrics could be damaged.**

Remove all objects from pockets and observe the following information:

- Tie cloth belts, apron strings, etc. together or use a laundry bag.
- Close zips, hooks and eyelets and buttons. Button up large items of laundry, such as covers.
- Remove any metal objects, such as paper clips, from pockets.
- To ensure a consistent drying result, sort laundry by fabric type and drying programme.
- Always dry very small items of laundry, e.g. babies' socks, together with large items such as towels.
- Knitted fabrics such as T-shirts and jerseys often shrink the first time they are tumble-dried. Use a gentle programme.
- Do not overdry easy-care laundry. This increases creasing of the laundry.
- Use timed programmes for single garments.
- Some detergents and care products, e.g. starch or softeners, contain particles which may be deposited on the moisture sensor. This may impair the sensor function and in consequence the drying result.

#### **Notes**

- When washing laundry to be tumble-dried, use the correct amount of detergent and care products as specified in the manufacturer's instructions.
- Clean the moisture sensor regularly → *Page 32*.

### Sorting washing according to:

- Suitable for tumble drying
- Dry at normal temperature
- Dry at low temperature
- Do not tumble-dry

**Note:** Do not load laundry from the washing machine directly into the tumble dryer. Sort the spun laundry before placing it in the dryer drum.

If you dry thin, thick and multi-layer fabrics together, they will dry to differing degrees. To achieve an even drying result, you should therefore only dry together laundry of the same type of fabric and structure. If you feel that the laundry is still too damp, you can select a timed programme for subsequent drying → *Page 22*.

#### **Caution!**















##### **Possibility of material damage to the dryer or laundry.**

##### **Do not tumble-dry the following fabrics:**

- Laundry contaminated with oil.
- Unwashed fabrics.
- Non-breathable fabrics (e.g. rubber-coated).
- Easily damaged fabrics such as silk, synthetic curtains.

## Programmes and buttons

### Programmes

Programme and fabrics	Maximum load and programme settings/info
Name of the programme Which fabrics is the programme suitable for?	The maximum load is based on the dry weight of the fabrics Possible programme settings
<b>Cottons</b>  Cupboard-dry plus  Hard-wearing, heat-resistant fabrics that are made of more than one layer of cotton or linen and do not dry readily.	<b>8 kg</b>
<b>Cottons</b>  Cupboard-dry  Normal, hard-wearing and heat-resistant fabrics made of a single layer of cotton or linen.	<b>8 kg</b>
<b>Cottons</b>  Iron-dry  Normal, hard-wearing and heat-resistant fabrics made of a single layer of cotton or linen that need to be damp after drying and are suitable for ironing or hanging up.	<b>8 kg</b>
<b>Easy-care</b>  Cupboard-dry plus  Synthetic or blended fabrics that are made of more than one layer and do not dry readily.	<b>3.5 kg</b>
<b>Easy-care</b>  Cupboard-dry  Normal synthetic or blended fabrics made of a single layer.	<b>3.5 kg</b>
<b>Easy-care</b>  Iron-dry  Normal synthetic or blended fabrics made of a single layer that need to be damp after drying and are suitable for ironing or hanging up.	<b>3.5 kg</b>
<b>Outdoor</b>  Weatherproof and outdoor clothing with a membrane coating and water-repellent fabrics.	<b>1.5 kg</b>
<b>Hygiene</b>  Hard-wearing towels made of cotton.	<b>6 kg</b>
<b>Mix</b>  Mixed load consisting of cotton and synthetic fabrics.	<b>3 kg</b>

**Time program warm** 

All types of fabric; time programme.

Suitable for pre-dried or slightly damp laundry and for drying off multi-layered, thick laundry.

**Notes**

- Only dry wool, sports shoes and soft toys with the basket for woollens → *Page 14*.
- In the time programme, the laundry's residual moisture is not automatically detected. If the laundry is still too damp after the drying programme, repeat the programme and, if required, extend the programme length.

**3 kg**

You can adjust the programme length using the button for the drying time.

**Time program cold** 

All types of fabric. For freshening up or airing items of laundry that have not been worn for long.

**3 kg**

You can adjust the programme length using the button for the drying time.

**Shirts 15'** 

For optimum drying results, dry a maximum of 5 shirts at one time. After drying, iron the laundry or hang it up and leave for a period of time: Residual moisture is then distributed evenly.

**1 kg****Rapid 40'** 

Synthetics and light cottons.

**2 kg****Wool finish** 

Fabrics made from wool or a wool blend that are suitable for tumble drying.

**0.5 kg****Lingerie** 

For delicate, washable underwear, e.g. made of velvet, lace, Lycra, silk or satin.

**1 kg**

## Buttons

Buttons	Explanations and notes
<b>Note:</b> Not all buttons and their functions can be selected in all programmes.	
<b>Fine adjust</b> ☼±	<p>If the laundry is too damp after drying, you can finely adjust the dryness level e.g. Cupboard Dry. The dryness level can be increased with the degree of dryness in three stages, from I ☼ to III ☼.</p> <p>If you have adjusted the dryness level, the setting for all programmes with a selectable dryness level is retained even after the dryer is switched off.</p> <p><b>Note:</b> The higher the degree of dryness, the longer the programme duration.</p>
<b>Drying time</b>	Adjust the programme length for the time programmes. Between 20 minutes and 3 hours, in 10-minute increments.
<b>Ready in</b>	The programme will end in 1-24 hrs. Set the "Ready in" time in increments of one hour to delay the start of the programme. The required number of hours after the programme ends is displayed in the display panel.
<b>Anti-crease</b>	The drum moves the laundry at regular intervals for 60 or 120 minutes after drying, in any programme, to prevent creasing.
<b>Gentle</b>	Reduced temperature for delicate fabrics, e.g. polyacrylic or elastane. Selecting the button will extend the drying time.
<b>Signal</b>	A signal sounds after the programme has ended.
<b>🔒 3 sec. (Childproof lock)</b>	Press and hold the "Ready in" time button and the drying time button at the same time for 3 seconds to activate or deactivate the childproof lock.
<b>Start/Reload</b>	Starts or pauses the programme.





## Operating the appliance

### Loading laundry and switching on the dryer

**Note:** The dryer must be correctly positioned and connected, → *Page 13*.

1. Place the laundry in the drum.
2. Turn the programme selector to any programme to switch the dryer on.
3. Close the dryer door.

#### Caution!

#### Possibility of material damage to the dryer or laundry.

Take care not to trap any laundry in the door.

### Setting a programme

**Note:** If you have activated the childproof lock, you must deactivate it before you can set a programme, see → *Page 24*.

1. Select the required programme; detailed information on the programmes can be found from → *Page 22* onwards.
2. Use the programme selector to set the required programme. The default programme settings for the selected programme appear in the display panel.

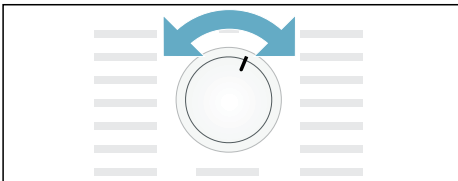

**Note:** Default programme settings are standard settings that are already defined when a programme is selected. After selecting a programme, you can see the default programme settings in the display panel.

3. If required, adjust the default programme settings. You can find detailed information on this from → *Page 22* onwards.

### Starting the programme

Press the Start button.

**Note:** If you want to lock the programme to prevent it from being adjusted inadvertently, you can select the childproof lock, see → *Page 24*.

### Programme sequence

The programme status is indicated in the display field.

e.g. **1:27** Expected programme duration in hours and minutes.

**Note:** When a programme is selected, the expected drying time for the recommended load is displayed. During drying moisture sensors detect the remaining moisture in the load and adjust the programme length (except timed programmes). This is visible via the time remaining leaping forward.

☰	Dry
☼	Iron Dry
☒	Cupboard Dry
☒	AntiCrease
- P -	Pause
End	End

## Changing the programme or adding laundry

You can remove or add laundry and change or alter the programme at any time during drying.

1. To pause the programme, open the dryer door or press the Start button.
2. Add or remove laundry.
3. Select another programme or an additional function, if required.
4. Close the dryer door.
5. Press the Start button.

**Note:** The programme duration in the display panel is updated depending on the load and residual moisture in the laundry. The values displayed may change after the programme is changed or the load is adapted.

## Cancelling the programme

The programme can be interrupted at any time; to pause, open the dryer door or press the Start button.

### Caution!

#### **Risk of fire. Laundry may catch fire.**

If you cancel the programme, you must remove the laundry items and spread them out so that the heat can disperse.

## Programme end

*End* appears in the display panel.

## Removing laundry and switching off the dryer

1. Remove the laundry.
2. Turn the programme selector to the "off" position.

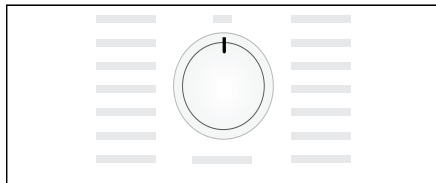

## Clean the fluff filter

**Note:** During drying, fluff and hair from the laundry is trapped by the fluff filter. If the fluff filter is blocked or dirty, this reduces the flow of air, which prevents the dryer from achieving its maximum performance. Clean fluff filters also reduce energy consumption and the drying time.

Clean the fluff filter **after each** drying cycle:

1. Open the dryer door and remove all fluff from the door.
2. Remove the fluff filter.

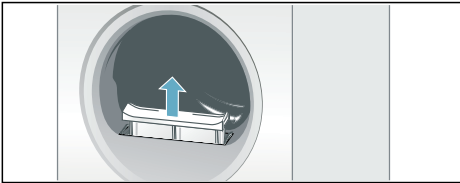

3. Remove the fluff from the recess in the fluff filter.

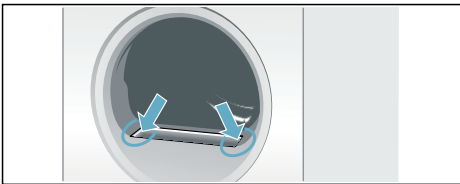

**Note:** Ensure that no fluff falls into the open shaft.

4. Open the fluff filter and remove all the fluff.
5. Rinse away the fluff under running water or clean the fluff filter in the dishwasher.

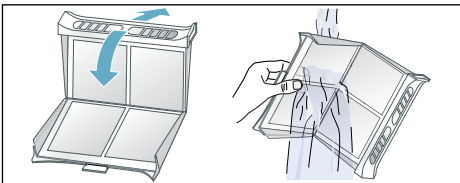

6. Dry the fluff filter, close it and reinsert the fluff filter.

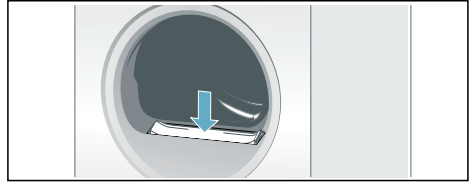

**Caution!**  
**The dryer may be damaged.**

Do not operate the dryer without a fluff filter or if the fluff filter is defective.

## Emptying the condensate container

By default, the condensation from the appliance runs into the condensation container.

Alternatively, you have the option of discharging the condensation water\* supplied depending on the model. If you choose to discharge the condensation water into the waste-water system, you will not need to empty the condensation container during the drying programme or after each time you use the dryer.

1. Pull out the condensate container horizontally.

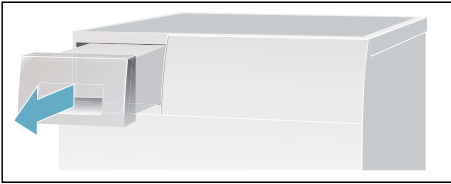

2. Pour out the condensation water.

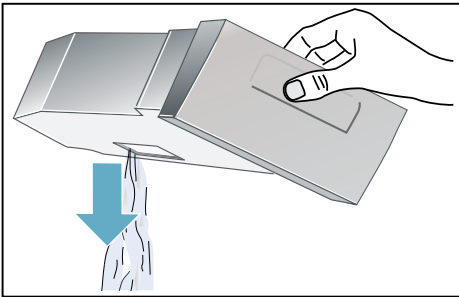

### Caution!

**Dirty condensation water may be harmful to your health and cause material damage.**

Condensation water is not suitable for drinking and may be contaminated with fluff. Do not drink the condensation water or reuse it.

\* into the waste-water system via a drain hose

3. Push in the condensate container until you feel it lock back into place in the dryer.

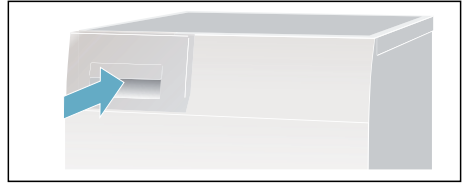

## Setting the signal and current

You can change the following settings:

- The spin speed that was used for spinning in the washing machine; used exclusively to more accurately display the anticipated drying time,
- the volume of the audible signal at the end of the programme,
- the volume of the audible button signals,
- the current rating for your dryer's fuse (10 A or 13 A).

**Note:** The values for the energy label are determined using a circuit breaker/fuse rating of 13 A. If the circuit breaker/fuse rating is changed to 10 A, the drying time and energy consumption will be higher. You can find details on this in the consumption values table.

→ Page 36

You will need to activate setting mode before you can change these settings.

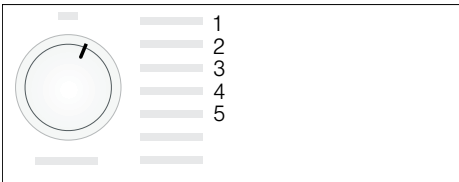

### Activating setting mode

1. Switch the dryer on.
2. Select the "Cottons" programme in position 1 and wait for five seconds. Setting mode is now activated. The symbols go out on the display panel and the programme duration is displayed.
1. Press and hold the Start button and, at the same time, turn the programme selector clockwise to position 2.
2. The **spin speed** is shown on the display.
3. Press the "Ready in" time button or the drying time button to change the spin speed.
4. Turn the programme selector clockwise to position 3.
5. The volume for the **audible signal at the end of the programme** is shown on the display.



0 = off, 1 = quiet, 2 = medium,  
3 = loud, 4 = very loud

6. Press the "Ready in" time button or the drying time button to change the volume.

7. Turn the programme selector clockwise to position 4.
8. The volume for the **audible button signal** is shown on the display.



- 0 = off, 1 = quiet, 2 = medium, 3 = loud, 4 = very loud
9. Press the "Ready in" time button or the drying time button to change the volume.
  10. Turn the programme selector clockwise to position 5.
  11. The **current** is shown on the display.  
LO = 10 A  
HI = 13 A
  12. Press the "Ready in" time button or the drying time button to change the current.

### Exiting setting mode

Turn the programme selector to the "Off" position once you have set the required spin speed, volume or fuse current rating. The settings have now been saved.

## Cleaning

### Cleaning the dryer and the control panel

#### **Warning** **Risk of death!**

There is a risk of electric shock as the dryer is operated with electricity. Disconnect the dryer from the mains before cleaning.

Clean the dryer using only water and a soft, damp cloth.

Remove all detergent residue, spray residue or other residues immediately. Do not use cleaning agents or agents for pre-treating laundry (e.g. prewash sprays, stain removers). Do not use high-pressure cleaners or steam jet cleaners to clean your appliance.

### Cleaning the heat exchanger

#### Notes

- Clean the heat exchanger several times a month if you use the dryer more than twice a week.
  - If there is debris in the heat exchanger, this will increase the amount of time required for drying and will compromise the drying results.
1. Allow the dryer to cool down and place an absorbent cloth beneath the maintenance flap.
- Note:** Residual water may leak out.
2. Open the maintenance flap fully.

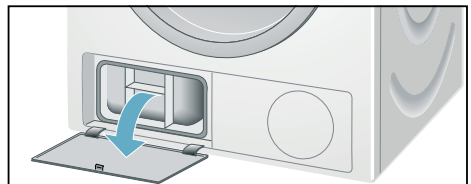

3. Turn both locking levers towards each other.

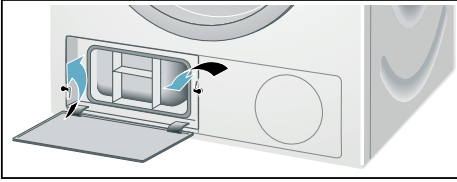

4. Remove the top cap from the heat exchanger.

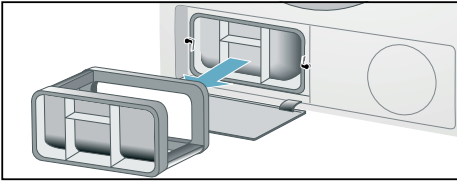

5. Remove the heat exchanger.

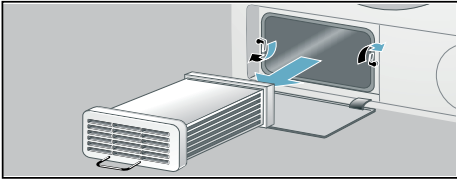

6. Flush water through the heat exchanger from all sides to completely remove all fluff.

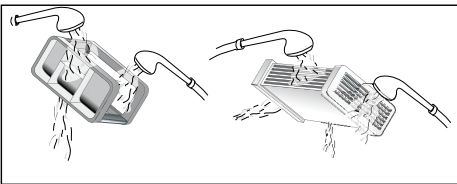

### Caution!

**There is a risk of damage to the heat exchanger.**

Only use water to clean the heat exchanger, and do not use any hard objects or objects with sharp edges to remove the fluff.

7. Remove all fluff from the seals on the dryer and on the heat exchanger.  
8. Allow all the water to drip off.

9. First insert the heat exchanger, and then fit the heat exchanger's top cap in place.  
10. Turn both locking levers back and close the maintenance flap until it locks into place.

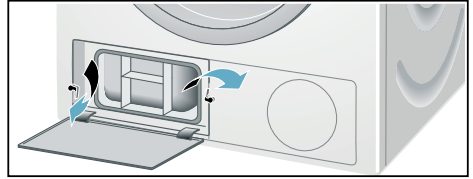

11. Close the maintenance flap and press on it until you feel it click in place.

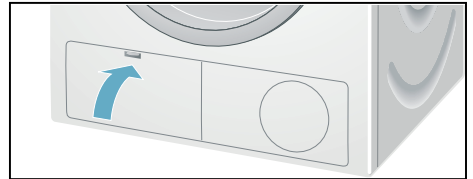

## Cleaning the moisture sensor

**Note:** The dryer is equipped with a stainless-steel moisture sensor. The moisture sensor measures how damp the laundry is.

After long periods of usage the moisture sensor may become covered by a fine layer of limescale or residues of detergents and care products. Such residues must be removed regularly as the sensor function and in consequence the drying result may be impaired.

Open the door and clean the moisture sensor with a coarse sponge.





### Caution!

**Moisture sensor may be damaged.**

Do not clean moisture sensors with abrasives and steel wool.



## Faults and what to do about them

Faults	Cause/remedy
 on the display panel and drying has been interrupted.	<ul style="list-style-type: none"> <li>■ Empty the condensate container and press the Start button → <i>Page 28</i>.</li> <li>■ If the optional condensation drain is installed, the drain hose may be blocked. Check the hose for deposits and flush the hose out.</li> </ul>
 on the display panel.	Clean the fluff filter and/or the heat exchanger, then select the Start button → <i>Page 27</i> ; → <i>Page 30</i> .
Dryer does not start.	<ul style="list-style-type: none"> <li>■ Mains plug plugged in or fuse checked?</li> <li>■ Programme selected? Select a programme.</li> <li>■ Dryer door open? Close the door.</li> <li>■ Childproof lock activated? Deactivate the childproof lock.</li> <li>■ "Ready in" time selected? Programme starts after a delay.</li> </ul>
Display panel goes off and Start button flashes.	Not a fault. Energy saving mode is active → <i>Page 12</i> .
Creasing.	<ul style="list-style-type: none"> <li>■ Creasing occurs when you have exceeded the maximum load or selected the wrong programme for the type of fabric. All the required information can be found in the programme table.</li> <li>■ Remove clothes immediately after drying; creasing may occur if they are left in the drum.</li> </ul>
Water is leaking out.	Not a fault; the dryer may be positioned on an incline. Level the dryer.
Change in the programme duration displayed during drying.	Not a fault. The moisture sensors detect the remaining moisture in the load and adjust the programme length (except timed programmes).
Laundry is not dried correctly or is still too damp.	<ul style="list-style-type: none"> <li>■ After the end of the programme, warm laundry feels damper than it actually is. Spread the laundry out and allow the heat to disperse.</li> <li>■ Finely adjust the dryness level – this extends the drying time but does not increase the temperature. Your laundry will become drier → <i>Page 24</i>.</li> <li>■ Select a programme with a longer drying time or increase the drying level. This does not increase the temperature.</li> <li>■ Select a timed programme for subsequent drying of laundry that is still damp → <i>Page 22</i>.</li> <li>■ If you have exceeded the maximum load for the programme, the laundry may not be dried properly.</li> <li>■ Clean the moisture sensor in the drum. The sensor may become covered by a fine layer of limescale or residues of detergents and care products which then impair its function. Your laundry is not being dried correctly → <i>Page 32</i>.</li> <li>■ Drying has been interrupted as a result of a power cut, because the condensate container is full or because the maximum drying time has been exceeded.</li> </ul> <p><b>Note:</b> See also the laundry tips → <i>Page 21</i>.</p>

\* Depending on the model

Faults	Cause/remedy
Drying time too long?	<ul style="list-style-type: none"><li>■ The fluff filter may be dirty and cause a longer drying time. Clean the fluff filter.</li><li>■ If the air inlet on the dryer is blocked or not freely accessible, this may increase the drying time. Make sure that the air inlet remains unobstructed.</li><li>■ If the ambient temperature is higher than 35 °C, this may extend the drying time.</li><li>■ Insufficient air circulation in the room may increase the drying time. Ventilate the room.</li></ul>
Humidity in the room increases.	Not a fault. Make sure the room is sufficiently ventilated.
Power cut.	The drying programme is interrupted. Remove the laundry and spread it out, or restart the programme.
* Depending on the model	

**Note:** If you cannot rectify the fault yourself by turning the dryer off and on, please contact our after-sales service.



## After-sales service

### **After-sales service**

If you cannot rectify the fault yourself (faults, what to do?), please contact our after-sales service. We will always find an appropriate solution to avoid unnecessary visits by engineers.

The contact information for your nearest after-sales service can be found here or in the enclosed after-sales service directory.

Please provide after-sales service with the dryer's product number (E-no.) and production number (FD).

E-Nr. _____ FD _____
----------------------

You can find this information on the inside of the dryer door or on the rear of the dryer.

### **Trust the expertise of the manufacturer.**

Contact us. You can therefore be sure that the repair is carried out by trained service technicians who carry original spare parts.



## Consumption values

Programme	Spin speed used for spinning the laundry	Duration**		Energy consumption**	
		8 kg	4 kg	8 kg	4 kg
		10/13 A	10/13 A	10/13 A	10/13 A
<b>Cottons</b>					
Cupboard-dry*	1400 rpm	136 min/ 115 min	85 min/ 65 min	4.52 kWh/ 4.41 kWh	2.54 kWh/ 2.49 kWh
	1000 rpm	158 min/ 137 min	106 min/ 82 min	4.76 kWh/ 4.63 kWh	2.68 kWh/ 2.61 kWh
	800 rpm	180 min/ 159 min	113 min/ 93 min	5.01 kWh/ 4.85 kWh	2.81 kWh/ 2.73 kWh
Iron-dry*	1400 rpm	113 min/ 86 min	64 min/ 48 min	3.41 kWh/ 3.39 kWh	1.94 kWh/ 1.91 kWh
	1000 rpm	135 min/ 108 min	78 min/ 62 min	3.65 kWh/ 3.61 kWh	2.08 kWh/ 2.03 kWh
	800 rpm	157 min/ 130 min	92 min/ 76 min	3.90 kWh/ 3.83 kWh	2.21 kWh/ 2.15 kWh
<b>Easy-care</b>		<b>3.5 kg</b>		<b>3.5 kg</b>	
Cupboard-dry*	800 rpm	52 min/ 46 min		1.46 kWh/ 1.42 kWh	
	600 rpm	65 min/ 56 min		1.79 kWh/ 1.74 kWh	
* Programme setting for testing in accordance with the applicable EN61121 standard.					
** The values may differ from those specified, depending on the type of fabric, composition of laundry to be dried, residual moisture in the laundry, the degree of dryness that has been set, the amount of laundry being loaded, the environmental conditions, and any additional functions that have been activated.					



## Technical data

**Dimensions:**

85 x 60 x 60 cm

Height x width x depth

**Weight:**

Approx. 45 kg

**Maximum load:**

8 kg

**Condensate container:**

4.6 l

**Connected voltage:**

220 - 240 V

**Connected load:**

Max. 2800/2100 W

**Fuse:**

13 A / 10 A

**Drum interior light\*****Ambient temperature:**

5 - 35 °C

**Power consumption when  
switched off:**

0.10 W

**Power consumption when  
ready for use (left-on mode):**

0.75 W

\* Depending on the model





## **Repair order and advice in the event of faults**

GB 0344 892 8999 (Calls charged at local or mobile rate.)

IE 01450 2655 (0.03 € per minute at peak. Off peak 0.0088 € per minute.)

You can find the contact information for all countries in the attached after-sales service directory.

BSH Hausgeräte GmbH

Carl-Wery-Straße 34

81739 München

GERMANY

[siemens-home.bsh-group.com](http://siemens-home.bsh-group.com)

Manufactured by BSH Hausgeräte GmbH under Trademark License of Siemens AG



9001495595 (9910)