

**Gaggenau**

en-us Use and Care Manual

# **CX49261x**

Full-surface induction cooktop

# Table of contents

<b>1 IMPORTANT SAFETY INSTRUCTIONS.....</b>	<b>3</b>	7.17 Pause function .....	31
1.1 Safety definitions.....	3	7.18 Basic settings .....	32
1.2 General information.....	3	<b>8 Home Connect® .....</b>	<b>33</b>
1.3 Intended use .....	3	8.1 Setting up the Home Connect® app.....	33
1.4 Restrictive Use.....	3	8.2 Setting up Home Connect®.....	33
1.5 Safe use.....	3	8.3 Overview of the Home Connect® settings .....	33
1.6 Safe use of the cooking sensor .....	6	8.4 Wi-Fi symbols  .....	34
1.7 Child safety .....	6	8.5 Changing settings via the Home Connect® app .....	34
1.8 Electromagnetic interference.....	7	8.6 Software update .....	34
1.9 Proper installation and maintenance .....	7	8.7 Remote diagnostics.....	34
1.10 Safe use of batteries .....	8	8.8 Data Protection .....	35
1.11 State of California Proposition 65 Warnings .....	8	<b>9 Hood Control .....</b>	<b>35</b>
<b>2 Preventing material damage .....</b>	<b>9</b>	9.1 Resetting the Home Connect® settings.....	35
2.1 Overview of the most common types of damage.....	9	9.2 Controlling the extractor hood via the cooktop.....	35
<b>3 Environmental protection and energy-saving .....</b>	<b>9</b>	9.3 Overview of the hood control settings.....	36
3.1 Disposal of packaging .....	9	<b>10 Cleaning and maintenance .....</b>	<b>36</b>
3.2 Saving energy .....	9	10.1 Cleaning agents .....	36
<b>4 Suitable cookware .....</b>	<b>10</b>	10.2 Cleaning the glass ceramic cooktop .....	36
4.1 Size and characteristics of the cookware .....	10	10.3 Cleaning the cooktop frame.....	37
<b>5 Familiarizing yourself with your appliance .....</b>	<b>11</b>	10.4 Cleaning recommendations.....	37
5.1 Cooking surface .....	11	10.5 Maintenance.....	38
5.2 Control panel.....	11	<b>11 Troubleshooting .....</b>	<b>39</b>
5.3 Overview of the menus .....	12	11.1 Warnings.....	39
5.4 Cooking position display .....	12	11.2 Normal noises from your appliance .....	41
5.5 Residual heat indicator.....	13	11.3 Cookware test .....	41
<b>6 Before using for the first time .....</b>	<b>13</b>	<b>12 Disposal .....</b>	<b>41</b>
6.1 Initial cleaning .....	13	12.1 Disposal of your old appliance.....	41
6.2 Induction cooking .....	13	<b>13 FAQs .....</b>	<b>42</b>
6.3 Cookware.....	13	13.1 Using the appliance.....	42
6.4 Initial use.....	13	13.2 Noises .....	42
6.5 Configuring Home Connect.....	13	13.3 Cookware.....	42
<b>7 Operation.....</b>	<b>13</b>	13.4 Cleaning.....	44
7.1 Turning the cooktop on or off .....	13	13.5 Home network .....	44
7.2 Cooking zone settings.....	14	<b>14 Customer Service.....</b>	<b>44</b>
7.3 Recommended cooking settings .....	14	14.1 Model number (E-Nr.) and production number (FD).....	44
7.4 Dynamic cooking.....	16	14.2 Rating plate location.....	44
7.5 Professional cooking .....	17	<b>15 STATEMENT OF LIMITED PRODUCT WARRANTY .....</b>	<b>45</b>
7.6 Short-term timer .....	18	15.1 What this warranty covers & Who it applies to.....	45
7.7 Stopwatch .....	19	15.2 How long the warranty lasts .....	45
7.8 Booster function for pots .....	20	15.3 Repair/replace as your exclusive remedy .....	45
7.9 Pan Boost function .....	20	15.4 Out of warranty product.....	46
7.10 Keep warm.....	21	15.5 Warranty exclusions .....	46
7.11 Transfer function .....	21	15.6 Obtaining warranty service .....	46
7.12 Cooking sensor mode .....	22	15.7 Product information .....	46
7.13 Wireless cooking sensor .....	27		
7.14 Single dynamic cooking .....	29		
7.15 Teppanyaki mode .....	30		
7.16 Panel lock .....	31		



# IMPORTANT SAFETY INSTRUCTIONS

## READ AND SAVE THESE INSTRUCTIONS

Read all of the instructions carefully before using the appliance. In order to reduce the risk of fire, electric shocks and personal injuries when using the appliance, follow the basic safety precautions, including the following safety instructions.

### 1.1 Safety definitions

Here you can find explanations of the safety signal words used in this manual.

#### **WARNING**

This indicates that death or serious injuries may occur as a result of non-observance of this warning.

#### **CAUTION**

This indicates that minor or moderate injuries may occur as a result of non-observance of this warning.

#### **NOTICE:**

This indicates that damage to the appliance or property may occur as a result of non-compliance with this advisory.

**Note:** This alerts you to important information and/or tips.

### 1.2 General information

- Read this manual carefully.
- Keep the instructions, the appliance pass and the product information safe for future reference or for the next owner.
- Do not connect the appliance if it has been damaged in transit.

### 1.3 Intended use

Only a qualified electrician may connect appliances without plugs. The manufacturer is not responsible for damage caused by incorrect connections. Please see the Statement of Limited Product Warranty → *Page 45*.

The appliance can only be used safely if it is correctly installed according to the installation instructions. The installer is responsible for ensuring that the appliance works perfectly at its installation location.

Only use this appliance:

- To prepare meals and drinks.
- Under supervision. Never leave the appliance unattended when cooking for short periods.
- for normal household use and in enclosed spaces in a residential environment.

- up to an altitude of 13,100 ft (4000 m) above sea level.

Do not use the appliance:

- This appliance is not intended for operation with an external clock timer or a remote control.

When using the cooking sensor function, select the cooking zone on which you placed the cookware with the wireless cooking sensor.

### 1.4 Restrictive Use

This appliance is not intended for use by persons (including children) with reduced physical, sensory or mental capabilities, or lack of experience and knowledge, unless they have been given supervision or instruction concerning use of the appliance by a person responsible for their safety.

Do not let children play with the appliance.

When children become old enough to use the appliance, it is the responsibility of the parents or legal guardians to ensure that they are instructed in safe practices by qualified persons.

Children should be supervised to ensure that they do not play with the appliance.

### 1.5 Safe use

#### **WARNING**

When properly cared for, your new appliance has been designed to be safe and reliable.

- ▶ Read all instructions carefully before use. These precautions will reduce the risk of burns, electric shock, fire, and injury to persons.
- ▶ When using kitchen appliances, basic safety precautions must be followed, including those in the following pages.

#### **WARNING**

While cooking food items, small amounts of certain by-products, such as particulate matter / soot, can be released. To minimize exposure to these substances:

- ▶ Always ensure proper ventilation by using an appropriate ventilation fan or hood vented to the outside and/or an open window.
- ▶ Always operate the unit according to the instructions in this manual.



# IMPORTANT SAFETY INSTRUCTIONS

## READ AND SAVE THESE INSTRUCTIONS

---

### WARNING

Overheated materials can cause fire or burns and may produce potentially harmful smoke or fumes.

- ▶ To prevent overheating, turn ventilation hood ON when heating grease, fats or frying using medium to high heat settings.
- ▶ Avoid heating empty pots and pans.
- ▶ Do not allow pans to boil dry.
- ▶ Do not allow aluminum foil, plastic, paper, or cloth to come in contact with a hot surface element, burner, or grate.

### WARNING

To avoid risk of fire, do not leave the cooktop unattended while in use. Unattended cooking can lead to fire hazards, property damage, and injury. Always supervise cooking, especially when using high heat with oils and fats. Boilovers may cause smoking and greasy spillovers may ignite.

### WARNING

A fire could occur during cooking.

- ▶ Always have a working smoke detector near the kitchen.
- ▶ Have an appropriate fire extinguisher available, nearby, highly visible and easily accessible near the appliance. If the cooktop is near a window, forced air vent or fan, be certain that flammable materials such as window coverings do not blow over or near the burners or heating elements. They could catch on fire.

Cooking fires can spread if extinguished incorrectly.

- ▶ Never use water on cooking fires.

### WARNING

TO REDUCE THE RISK OF A GREASE FIRE

- ▶ Never Leave Surface Units Unattended at High Settings - Boilovers cause smoking and greasy spillovers that may ignite. Heat oils slowly on low or medium settings.
- ▶ Always turn hood ON when cooking at high heat or when flambeing food (i.e. Crepes Suzette, Cherries Jubilee, Peppercorn Beef Flambe').
- ▶ Clean ventilating fans frequently. Grease should not be allowed to accumulate on fan or filter.
- ▶ Use proper pan size. Always use cookware appropriate for the size of the surface element.
- ▶ Do not flambé under the extractor hood or work with a naked flame. When switched on, the extractor hood draws flames into the filter. There is a risk of fire due to deposits on the grease filter!

Flames can be drawn into the ventilation system.

- ▶ Whenever possible, do not operate the ventilation system during a cooktop fire. However, do not reach through fire to turn it off.

Cookware Handles Should be Turned Inward and Not Extend Over Adjacent Surface Units.

- ▶ To reduce the risk of burns, ignition of flammable materials, and spillage due to unintentional contact with the cookware, the handle of a cookware should be positioned so that it is turned inward, and does not extend over adjacent surface units.

Wear Proper Apparel. Loose-fitting or hanging garments, such as ties, scarves, jewelry, or dangling sleeves, should never be worn while using the appliance.

- ▶ Tie long hair so that it does not hang loose.
- ▶ Secure all loose garments, etc. before beginning.

Use Proper Pan Size - This appliance is equipped with one or more surface units of different sizes.

- ▶ Select cookware having flat bottoms large enough to cover the surface unit cooking zone.
- ▶ The use of undersized cookware will expose a portion of the cooking zone to direct contact and may result in ignition of clothing. Proper relationship of cookware to cooking zone will also improve efficiency.

Controls may be operated unintentionally by spills covering the control panel.

- ▶ Never use the appliance if liquids or foods have spilled around the control panel.
- ▶ Always turn off the cooktop and dry the control panel. Boilovers can cause smoke and some foods and oils may catch fire if left on high temperature settings.
- ▶ When using a timer, always supervise the cooktop.
- ▶ Do not allow anything to boil over or burn.

If the cooktop turns off automatically and can no longer be operated, it may turn itself on unintentionally at a later point.

- ▶ Switch off the circuit breaker or fuse in the electrical panel.
- ▶ Contact Customer Service for support.

### CAUTION

The cooking process has to be supervised. A short term cooking process has to be supervised continuously.

### WARNING

If the display does not work when a cooking area is heating up disconnect the circuit breaker or fuse in the electrical panel.

- ▶ Contact an authorized service provider.



# IMPORTANT SAFETY INSTRUCTIONS

## READ AND SAVE THESE INSTRUCTIONS

To avoid risk of fire do not store items on the cooking surfaces.

In the event that personal clothing or hair catches fire, drop and roll immediately to extinguish flames.

Do Not Use Water on Grease Fires.

- ▶ Smother fire or flame or use dry chemical or foam-type extinguisher.

### WARNING

Use Only Dry Potholders - Moist or damp potholders on hot surfaces may result in burns from steam.

- ▶ Do not let potholders touch hot heating elements.
- ▶ Do not use a towel or other bulky cloth.

Hot oil is capable of causing extreme burns and injury.

- ▶ Use high heat settings on the cooktop only when necessary.
- ▶ To avoid bubbling and splattering, heat oil slowly on no more than a low-medium setting.
- ▶ Never move a pan of hot oil, especially a deep fat fryer. Wait until it is cool.

Spills of hot food may cause burns.

- ▶ Hold the handle of the pan when stirring or turning food.

This helps prevent spills and movement of the pan.

DO NOT TOUCH SURFACE UNITS OR AREAS NEAR UNITS. Surface units may be hot even though they are dark in color. Areas near surface units may become hot enough to cause burns.

- ▶ During and after use, do not touch, or let clothing, potholders, or other flammable materials contact surface units or areas near units until they have had sufficient time to cool. Among these areas are the cooktop and areas facing the cooktop.

### WARNING

Do not place metallic objects such as knives, forks, spoons, and lids on the cooktop surface since they can get hot.

Clean Cooktop With Caution.

- ▶ If a wet sponge or cloth is used to wipe spills on a hot cooking area, be careful to avoid steam burn.
- ▶ Some cleaners can produce noxious fumes if applied to a hot surface.
- ▶ Do not clean the appliance while it is still hot.

### WARNING

The pan detection shut-off feature may not turn off the cooking zone due to spilled food or objects placed on the cooktop.

- ▶ Keep the cooktop clean and do not store objects on the cooking zones.

### CAUTION

If the temperature sensing system is not working properly, boilovers may result causing burns and injury. WHEN COOKING WITH THE COOKING SENSOR FUNCTION OBSERVE THE FOLLOWING

- ▶ Always put the lid on pots.
- ▶ Always fill pots with at least 1¼" (3 cm) of liquid.
- ▶ Always use pots of the appropriate size and type (enamelware pots, stainless steel and aluminum pots equipped with wireless temperature sensor).
- ▶ Always keep the sensor's window clean.
- ▶ When using the cooking sensor functions, make sure that the cookware with the wireless temperature sensor is placed on the cooking zone where you make the settings.

### WARNING

Storage in or on Appliance - The use of corrosive chemicals in heating or cleaning will damage the appliance and could result in injury.

- ▶ Flammable materials, corrosive chemicals, vapors or non-food products should not be stored or used in an oven or on or near surface units.
- ▶ The appliance is specifically designed for use when heating or cooking food.

This appliance is intended for normal family household use only. It is not approved for outdoor use. See the Statement of Limited Product Warranty. If you have any questions, contact the manufacturer.

### WARNING

Using this appliance other than for its intended use can cause fire or injury to persons.

- ▶ Use this appliance only for its intended use as described in this manual.
- ▶ NEVER use your appliances as a space heater for warming or heating the room. Doing so may result in overheating the appliance.
- ▶ Never use the appliance for storage.

### WARNING

TO REDUCE THE RISK OF INJURY TO PERSONS IN THE EVENT OF A GREASE FIRE, OBSERVE THE FOLLOWING.

- ▶ SMOTHER FLAMES with a close-fitting lid, cookie sheet, or metal tray, then turn off the burner. BE CAREFUL TO PREVENT BURNS. If the flames do not go out immediately, EVACUATE AND CALL THE FIRE DEPARTMENT.



# IMPORTANT SAFETY INSTRUCTIONS

## READ AND SAVE THESE INSTRUCTIONS

- ▶ NEVER PICK UP A FLAMING PAN – You may be burned.
- ▶ DO NOT USE WATER, including wet dishcloths or towels – a violent steam explosion will result.
- ▶ Use an extinguisher ONLY if:
  - You know you have a Class ABC extinguisher, and you already know how to operate it.
  - The fire is small and contained in the area where it started.
  - The fire department is being called.
  - You can fight the fire with your back to an exit.

Do not heat or warm unopened food containers. Build-up of pressure may cause the container to burst and cause injury.

Liquid between the pot base and the cooktop may build up steam pressure. This may cause the pot to jump suddenly causing injury.

- ▶ Always keep the cooktop and bases of pots dry. When cooking with a double-boiler, the cooktop and cooking vessel may crack due to overheating.
- ▶ The cooking vessel in the double-boiler must not come in direct contact with the bottom of the pot filled with water.
- ▶ Use only heat-resistant cookware.

Injury and damage to the appliance may occur if control elements are not used properly.

### WARNING

Moisture intrusion may cause an electric shock.

- ▶ Do not use any steam cleaners or high-pressure cleaners to clean the appliance.
- If the appliance or the power cord is damaged, this is dangerous.
- ▶ Do not turn the power on if the appliance or the power cord is damaged. Doing so may cause injury.
  - ▶ Never operate a damaged appliance.
  - ▶ If the surface is cracked, you must switch off the appliance in order to prevent a possible electrical shock. To do this, switch off the appliance via the circuit breaker in the circuit breaker panel rather than at the main switch.
  - ▶ If the appliance or the power cord is damaged, immediately switch off the breaker in the circuit breaker box.
  - ▶ Call Customer Service. → *Page 44*
  - ▶ Repairs to the appliance should only be performed by an authorized service provider.

### WARNING

If the surface is cracked, switch off the appliance to avoid the possibility of electric shock.  
Do Not Cook on a Broken Cooktop - If the cooktop should break, cleaning solutions and spillovers may penetrate the broken cooktop and create a risk of electric shock.

- ▶ Contact an authorized service provider immediately.

## 1.6 Safe use of the cooking sensor

### WARNING

The wireless temperature sensor is powered by a battery, which may become damaged if it is exposed to high temperatures.

- ▶ Remove the sensor from the cookware and store it away from any heat sources.
- The temperature sensor may be very hot when removing it from the saucepan.
- ▶ Wear oven gloves or use a tea towel to remove it.

### WARNING

The wireless temperature sensor is magnetic and may damage electronic implants, e.g. heart pacemakers or insulin pumps.

- ▶ Persons with electronic implants must stand at least 10 cm away from the magnetic control element.
- ▶ Never put the control element in your pockets.

### WARNING

Children may pull packaging material over their heads, or wrap themselves up in it and suffocate.

- ▶ Keep packaging material away from children.
- ▶ Do not allow children to play with packaging material. Children may breathe in or swallow small parts, causing them to suffocate.
- ▶ Keep small parts away from children.
- ▶ Do not allow children to play with small parts.

## 1.7 Child safety

This appliance is not intended for use by persons (including children) with reduced physical, sensory or mental capabilities, or lack of experience and knowledge, unless they have been given supervision or instruction concerning use of the appliance by a person responsible for their safety.

When children become old enough to use the appliance, it is the responsibility of the parents or legal guardians to ensure that they are instructed in safe practices by qualified persons.





# IMPORTANT SAFETY INSTRUCTIONS

## READ AND SAVE THESE INSTRUCTIONS

Children should be supervised to ensure that they do not play with the appliance.

### WARNING

Do not allow children to use this appliance unless closely supervised by an adult.

- ▶ Children and pets should not be left alone or unattended in the area where the appliance is in use. They should never be allowed to play in its vicinity, whether or not the appliance is in use.

Do not allow anyone to climb, stand, lean, sit, or hang on any part of an appliance, especially a door, warming drawer, or storage drawer.

- ▶ This can damage the appliance, and the unit may tip over, potentially causing severe injury.

Do not let children play with the appliance.

### CAUTION

Do not store items of interest to children in cabinets above an appliance or on the backguard of an appliance.

Children climbing on the appliance to reach items could be seriously injured.

Do Not Leave Children Alone.

- ▶ Children should not be left alone or unattended in the area where the appliance is in use.
- ▶ They should never be allowed to sit or stand on any part of the appliance.

### WARNING

To avoid the risk of suffocation:

- ▶ Do not allow children to play with packaging material.

## 1.8 Electromagnetic interference

### WARNING

This induction cooktop generates and uses ISM frequency energy that heats cookware by using an electromagnetic field. It has been tested and complies with Part 18 of the FCC Rules for ISM equipment. This induction cooktop meets the FCC requirements to minimize interference with other devices in residential installation. Induction cooktops may cause interference with television or radio reception. If interference occurs, the user should try to correct the interference by

- ▶ Relocating the receiving antenna of the radio or television.
- ▶ Increasing the distance between the cooktop and the receiver.
- ▶ Connecting the receiver into an outlet different than the cooktop.

- ▶ It is the user's responsibility to correct any interference.

### CAUTION

Persons with a pacemaker or similar medical device should exercise caution when standing near an induction cooktop while it is in use.

- ▶ Consult your doctor or the manufacturer of the pacemaker or similar medical device for additional information about its effects with electromagnetic fields from an induction cooktop.

### WARNING

The wireless cooking sensor is magnetic and can damage electronic implants, such as heart pacemakers or insulin pumps.

- ▶ Persons with electronic implants must maintain a distance of at least 4" (10 cm) from the wireless cooking sensor.
- ▶ Never put the wireless cooking sensor in your pockets.

## 1.9 Proper installation and maintenance

### WARNING

In the event of a malfunction, it might become necessary to turn off the power supply.

- ▶ Have the installer show you the circuit breaker or fuse. Mark it for easy reference.

To avoid electrical shock hazard, before servicing the appliance, turn power off at the service panel and lock the panel to prevent the power from being switched on accidentally.

Proper Installation - Improper installation or grounding can cause electric shock.

- ▶ This appliance must be properly installed and grounded by a qualified technician.
- ▶ Connect only to properly grounded outlet.
- ▶ Refer to installation instructions for details.

User Servicing - Do not repair or replace any part of the appliance unless specifically recommended in this manual.

- ▶ All other servicing should be referred to an authorized service provider.

If the supply cord is damaged, it must be replaced by the manufacturer, its authorized service provider or similar qualified persons in order to avoid hazard.



# IMPORTANT SAFETY INSTRUCTIONS

## READ AND SAVE THESE INSTRUCTIONS

### CAUTION

The cooktop is equipped with a cooling fan on its underside. Materials may be sucked into the fan and compromise the cooling of the appliance or damage the fan.

- ▶ If the cooktop is installed above a drawer, the drawer must not contain any objects or paper.
- ▶ There must be a minimum distance of 3/4" (20 mm) between the content of the drawer and the fan input.

### WARNING

Malfunctions can cause injuries.

- ▶ Do not operate this appliance if it is not working properly, or if it has been damaged. Contact an authorized service provider.

## 1.10 Safe use of batteries

- Always completely secure the battery compartment. If the battery compartment does not close securely, stop using the product, remove the batteries, and keep them away from children.



### 1.11 State of California Proposition 65 Warnings

This product may contain a chemical known to the State of California, which can cause cancer or reproductive harm. Therefore, the packaging of your product may bear the following label as required by California:

**STATE OF CALIFORNIA PROPOSITION 65 WARNING:**

 **WARNING**

Cancer and Reproductive Harm - [www.P65Warnings.ca.gov](http://www.P65Warnings.ca.gov)

 <b>WARNING</b>	
<ul style="list-style-type: none"> <li>• <b>INGESTION HAZARD:</b> This product contains a button cell or coin battery.</li> <li>• <b>DEATH</b> or serious injury can occur if ingested.</li> <li>• A swallowed button cell or coin battery can cause <b>Internal Chemical Burns</b> in as little as <b>2 hours</b></li> <li>• <b>KEEP</b> new and used batteries <b>OUT OF REACH</b> of CHILDREN</li> <li>• <b>Seek immediate medical attention</b> if a battery is suspected to be swallowed or inserted inside any part of the body.</li> </ul>	

- Remove and immediately recycle or dispose of used batteries according to local regulations and keep away from children. Do NOT dispose of batteries in household trash or incinerate.
- Even used batteries may cause severe injury or death.
- Call a local poison control center for treatment information.
- Compatible battery type: CR2032
- Nominal battery voltage: 3V
- Non-rechargeable batteries are not to be recharged.
- Do not force discharge, recharge, disassemble, heat above (manufacturer's specified temperature rating) or incinerate. Doing so may result in injury due to venting, leakage or explosion resulting in chemical burns.
- Ensure the batteries are installed correctly according to polarity (+ and -).
- Do not mix old and new batteries, different brands or types of batteries, such as alkaline, carbon-zinc, or rechargeable batteries.
- Remove and immediately recycle or dispose of batteries from equipment not used for an extended period of time according to local regulations.



## 2 Preventing material damage

### NOTICE:

Cookware with rough bottoms scratch the glass ceramic surface.

- ▶ Check the bottom of the cookware before setting it down.

Salt, sugar or grains of sand scratch the glass ceramic surface.

- ▶ Never use the cooktop as a working surface or for setting things down.

Overheating can damage the cookware.

- ▶ Do not heat empty pots or pans.

Hot cookware can cause the electronics to overheat.

- ▶ Never set down hot pans and pots on the control panel or the cooktop frame.

When hard or sharp objects fall on the cooktop, they can cause damage.

- ▶ Do not let hard or pointed objects fall on the cooktop.

Aluminum foil and plastic melt on hot cooking zones.

- ▶ Do not let aluminum foil or plastic come into contact with hot cooking zones.
- ▶ Do not use cooktop protective film.

Unsuitable cleaning agents can cause shimmering metallic discolorations on the glass ceramic surface.

- ▶ Refer to the cleaning recommendations in this manual.  
→ "Cleaning and maintenance", Page 36

### 2.1 Overview of the most common types of damage

Here you can find an overview of the most common types of damage and suggestions how to avoid them.

#### Stains

Cause	How to avoid
Boiled-over food	Remove boiled-over food immediately with a glass scraper.
Unsuitable cleaning agents	Use cleaning agents that are suitable for glass ceramic cooktops.

#### Scratches

Cause	How to avoid
Salt, sugar and sand	Do not use the cooktop as a work surface or storage space.
Cookware with rough bases	Check the cookware.

#### Discolorations

Cause	How to avoid
Unsuitable cleaning agents	Use cleaning agents that are suitable for glass ceramic cooktops.
Pot abrasion (e.g. aluminum)	Lift pots and pans when moving them.

#### Blisters

Cause	How to avoid
Sugar, food with a high sugar content	Remove boiled-over food immediately with a glass scraper.

## 3 Environmental protection and energy-saving

### 3.1 Disposal of packaging

The packaging materials are environmentally compatible and can be recycled.

- ▶ Sort the individual components by type and dispose of them separately.

### 3.2 Saving energy

If you follow these tips, your appliance consumes less energy.

Select cookware with a base diameter that matches the cooking zone. Center the cookware on the cooking zone.

**Tip:** For frying pans, cookware manufacturers usually state the top diameter of the cookware. The diameter of the pan base is usually smaller.

- ✓ The energy is targeted at the cookware.  
If you use cookware that is too small, energy is wasted.  
If the cookware is too large, much energy is used to heat up the cookware.

Close cookware with a fitting lid.

- ✓ Cooking without a lid consumes more energy.

Only lift the lid when necessary.

- ✓ If you lift the lid, a lot of energy can escape.

Use a glass lid.

- ✓ If you use a glass lid, you can look inside the cookware without lifting the lid.

Use cookware with a solid flat bottom.

- ✓ Curved cookware bases increase energy consumption.

Use a cookware size that matches the amount of food you want to cook.

- ✓ Large cookware with little content consumes a lot of energy.

Cook with a small amount of water.

- ✓ More water requires more energy to heat it up.

Select a lower power level as soon as possible. Select a suitable power level to continue cooking.

- ✓ For ongoing cooking a lower power level is sufficient.

## 4 Suitable cookware



Cookware that is suitable for induction cooking must have a ferromagnetic base. This means that the cookware must be magnetic and be the recommended size.

The cooktop uses the ferromagnetic diameter and material of the base of the cookware to automatically detect the position, size and shape of the cookware being used. Follow the cookware manufacturer's instructions.

Cookware with a base measuring 3½" to 13⅞" (90 to 340 mm) in diameter is suitable for use.

### 4.1 Size and characteristics of the cookware

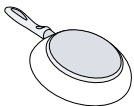
To be able correctly detect the cookware, you must take the size and the material of the cookware into consideration. All cookware bases must be perfectly flat and smooth.

Cookware	Materials	Properties
Recommended cookware	Stainless steel cookware in a sandwich design that distributes the heat well.	This cookware distributes the heat evenly, heats up quickly, and ensures that it can be detected easily.
	Ferromagnetic cookware made of enameled steel, cast iron, or special induction cookware made of stainless steel.	This cookware distributes the heat evenly, heats up quickly, and ensures that it can be detected.
Suitable	The base is not fully ferromagnetic.	If the ferromagnetic area is smaller than the base of the cookware, only the area that is ferromagnetic heats up. As a result, the heat is not distributed evenly.
 	Cookware bases with aluminum content.	These cookware bases reduce the ferromagnetic area, which means that less power is emitted to the cookware. This cookware may not be sufficiently detected or may not be detected at all, and therefore does not heat sufficiently.
Not suitable	Cookware made from normal thin steel, glass, clay, copper or aluminum.	

#### Notes

- Do not use adapter plates between the cooktop and the cookware.
- Do not heat up empty cookware and do not use cookware with a thin base, as this may become very hot.

## 5 Familiarizing yourself with your appliance

This Use and Care Manual covers several models. Your model may have some but not all of the features listed.

### 5.1 Cooking surface

The entire cooking surface of the cooktop supplies induction heating. You can place cookware anywhere inside the usable area of the cooking surface. The position, size and shape of the cookware will be detected automatically.

You can heat up to six items of cookware at the same time on the cooking surface.

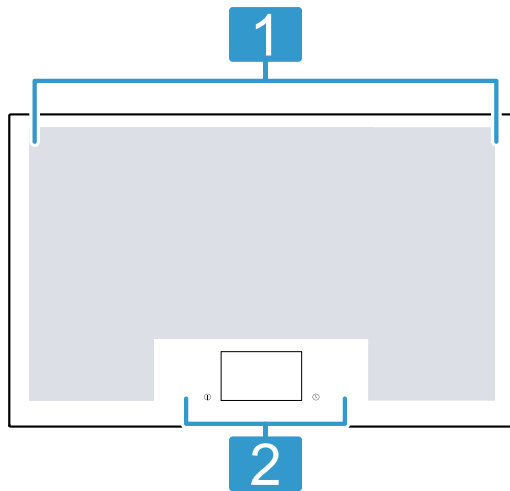

### 5.2 Control panel

You can use the control panel to configure all functions of your appliance and to obtain information about the operating status.

The control panel has touch keys and a touchscreen display.

The touchscreen display gives you an overview of the cookware on the cooking surface and displays touch fields for activating the various functions.

When an item of cookware is placed on the cooking surface, the cooking position for this cookware is shown on the display.

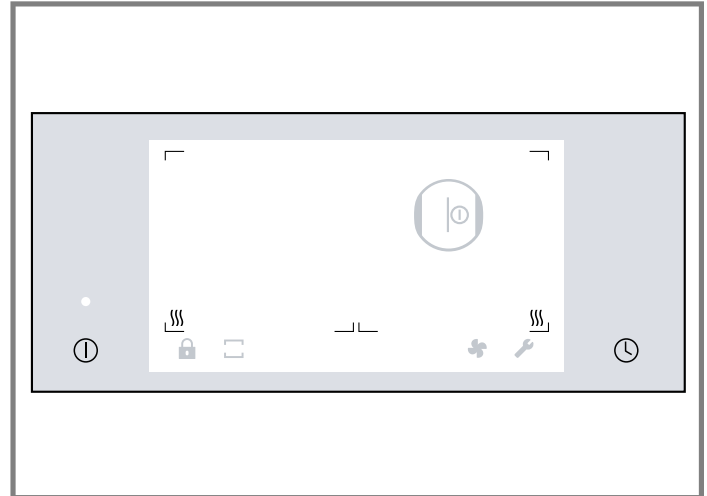

### Touch keys and touch fields

The touch keys and fields are touch-sensitive. To select a function, touch the relevant symbol. The available functions light up on the display.

Touch key / touch field	Function
ⓘ	Main switch
⌚	Timer menu <ul style="list-style-type: none"> <li>■ ⌚ Short-term timer</li> <li>■ ⌚ Stopwatch</li> </ul>
🔒	Panel lock
⏸	Pause function
☐	Cooktop modes
⬆	Cooktop mode: Dynamic cooking
⏸	Cooktop mode: Professional cooking
☐	Cooktop mode: Classic cooking
🌀	Hood control
🔧	Basic settings
ⓘ	Detected cooking position
1.0 - 9.0	Power levels
➤➤	Power Boost Function
➤	Pan Boost function
☐	Keep warm function
🍲	Cookware modes
🍲	Cookware mode: Single dynamic cooking for one item of cookware
🍲	Cookware mode: Classic cooking for one item of cookware
🍲	Cookware mode: Cooking sensor function
☐	Cookware mode: Teppanyaki

### 5.3 Overview of the menus

The intuitive menu structure helps you to find your way around the control panel of your appliance. You can find out more about the most important menus in this section.











#### Main screen

The main display provides an overview of the indicators for the cookware on the cooking surface. It displays the cooking mode and power levels that are set for the cooking zones that are switched on.

#### Function bar

The function bar at the bottom of the touchscreen display provides access to a number of functions and to other menus.

The following options may be displayed in the function bar:

	Panel lock
	Pause function
	Cooktop modes
	Hood control
	Basic settings
	Confirm settings
	Exit current menu
	Edit setting
	Stop timer
	Start timer
	Information

#### Info menu

The info menu provides you with information about the appliance or the functions that are currently active. To access the info menu, touch the  symbol on the function bar. The sensor will show when the function is available.

#### Notifications and alerts

The notifications and alerts support you in operating your appliance correctly

Notifications:

- Notifications inform you that the appliance's status has changed or that you need to confirm something.
- The top line of the display lights up orange.
- To return to the main screen, touch .



Alerts:

- The alerts inform you that action is required.
- The top line of the display lights up blue.
- Follow the instructions on the display.
- To return to the main screen, touch .

#### Cooktop mode menu

The cooktop has various functions that apply to the entire cooking surface.





Touch  to enter the cooktop mode menu.

Cooking mode	Function
 Professional cooking	Allows you to select the power level based on the position of the cookware on the cooking surface, from right to left.
 Classic cooking	Allows you to select the power level for the cooking position.
 Dynamic cooking	Allows you to select the power level based on the position of the cookware on the cooking surface, from front to back.

#### Cookware mode menu

The cooktop has various functions that apply to the individual cooking positions.





To access the cookware mode menu, ta the cooking position display and then touch .

Cookware mode	Function
 Single dynamic cooking for one item of cookware	Allows you to select a particular power level based on the position of the cookware by moving it from front to back on the cooking surface.
 Classic cooking for one item of cookware	Allows you to select the power level for each item of cookware directly on the control panel.
 Cooking sensor mode	You can use the cooking sensor that is attached to the outside of the cookware to automatically keep the temperature at a set level. The Cooking Sensor mode is suitable for food that requires large quantities of water, oil or fat for boiling or deep fat frying in a pot.
 Teppanyaki mode	Allows you to divide the Teppan Yaki surface into two sections with different settings. Depending on the settings, you can fry food on one section and keep food warm on the other section, or use the entire area to fry food at the same power level.



### 5.4 Cooking position display

When you place cookware on the cooking surface, the indicator for the relevant cooking position lights up on the touchscreen display.

The display gives you information on the operating status of the cooking position.

Cooking position display	Meaning
	<p>Detected cooking position</p> <ul style="list-style-type: none"> <li>▪ The cookware on the cooking surface has been detected.</li> <li>▪ The cooking position display lights up.</li> <li>▪ Touch the ① symbol to select the cooking position.</li> </ul>
	<p>Selected cooking position</p> <ul style="list-style-type: none"> <li>▪ The cooking position has been selected.</li> <li>▪ You can set the power setting.</li> </ul>
	<p>Cooking position active</p> <ul style="list-style-type: none"> <li>▪ The indicated cooking position has been turned on.</li> <li>▪ The selected power level lights up in the display.</li> </ul>
	<p>No cookware on the cooking position</p> <ul style="list-style-type: none"> <li>▪ The cookware has been removed from the cooking surface.</li> <li>▪ The selected power level is dimmed.</li> </ul>
	<p>Other indicators and symbols</p> <ul style="list-style-type: none"> <li>▪ The settings for the cooking position cannot be configured.</li> <li>▪ Touch the display for more information.</li> </ul> <p>Possible causes:</p> <ul style="list-style-type: none"> <li>▪ Up to 6 items of cookware evenly distributed over the cooking surface can be heated at the same time.</li> <li>▪ The cookware is not suitable for use on an induction cooktop.</li> <li>▪ The appliance has exceeded its maximum power consumption.</li> </ul>

## 5.5 Residual heat indicator

The cooktop is equipped with several residual heat indicators . The residual heat indicators warn you that one or more cooking positions are still hot. Depending on how strong the residual heat is, one, two or all three bars of the  indicator will light up. Do not touch the cooking surface while the indicators are still lit or immediately after they have gone out. When you turn off the cooktop the residual heat indicators will remain lit for as long as the cooking surface is still hot.

## 6 Before using for the first time

Observe the following recommendations.

### 6.1 Initial cleaning

Remove any leftover packaging from the cooktop surface and wipe the surface with a damp cloth. You can find a list of recommended detergents on the official website [www.gaggenau.com](http://www.gaggenau.com).

Further information on care and cleaning. → *Page 36*

### 6.2 Induction cooking

In comparison to conventional cooktops, cooking on an induction cooktop brings with it a series of changes and has a number of benefits such as time savings when cooking and frying, energy savings, as well as greater ease of cleaning and care. It also offers improved heat control as the heat is generated directly in the cookware.

### 6.3 Cookware

You can find a list of recommended cookware on the official website [www.gaggenau.com](http://www.gaggenau.com).

Further information on suitable cookware.

### 6.4 Initial use

When you switch on the appliance for the first time, the standard language setting appears on the display as a first step to configure the cooktop.

You can change these settings at any time in the basic settings. → *Page 32*

### 6.5 Configuring Home Connect

To start the connection settings, select the Home Connect setting in the basic settings and follow the instructions in the section entitled

→ "*Home Connect®*", *Page 33*.

## 7 Operation

Here you will find everything you need to know about operating your appliance.

### 7.1 Turning the cooktop on or off

Turn the cooktop on or off with the main switch.

#### Turning the cooktop on

- ▶ Press ①.
- ✓ The indicator above the main switch lights up.
- ✓ After a short time the cooktop is ready for operation.

#### Turning the cooktop off

- ▶ Press ①.
- ✓ The indicator above ① goes out.
- ✓ All cooking positions are turned off.

## Notes

- The cooktop turns off automatically when all the cooking zones have been turned off for more than 20 seconds.
- The selected settings will be stored for 30 seconds after the appliance has been turned off. If you turn the appliance back on during this time, the option to confirm the previous settings appears on the main screen.

## 7.2 Cooking zone settings

In order to make settings on a cooking zone, the cooking zone has to be selected.

Set the desired power level for each cooking zone in the cooking zone display.

Setting	Power level
1.0	lowest power level
9.0	highest power level

Every power level has an intermediate setting. This is shown in the cooking zone display as .5.

**Note:** The cooktop may temporarily reduce the power automatically to protect the fragile parts of your appliance and to prevent the appliance from producing excess noise.

### Setting a cooking zone

**Requirement:** The cooktop is turned on.

1. Place the cookware on the cooking surface.
  - ✓ The display shows that a cookware is detected.
2. Touch ① on the cooking zone display.

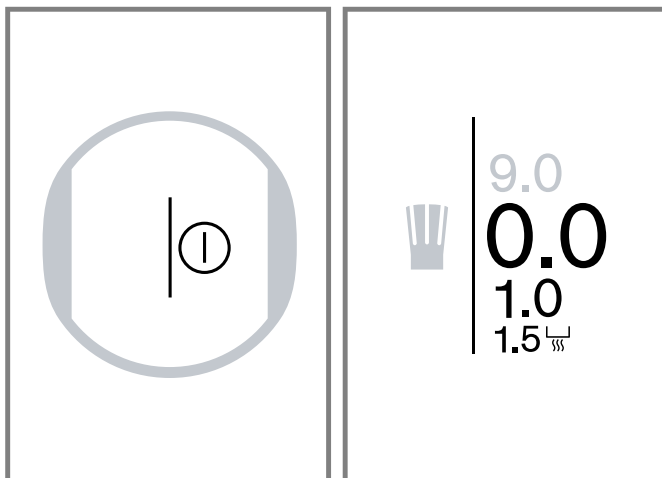

- ✓ The settings area lights up on the cooking zone display.

### Cooking charts

The cooking chart shows which power level is suitable for each type of food. The cooking time may vary depending on the type, weight, thickness and quality of the food.

3. Within the next 4 seconds, scroll up or down in the settings area with your finger until the required power level is in focus.

To select power level 9.0, tap 9.0 on the cooking zone display.

**Note:** If you place cookware on the cooking surface before turning on the cooktop, the cookware is detected when you press the main switch. The indicator for the cooking position will light up on the touch screen display.

### Changing the power level

- ▶ Select the cooking zone and set the required power level in the cooking zone display.

### Turning the cooking zone off

- ▶ Touch and hold the cooking zone display until power level 0.0 is displayed.

## 7.3 Recommended cooking settings

Here you can find recommendations on cooking and an overview of various dishes with suitable heat levels.

- Select power level 8 or 9 for bringing water to a boil or heating up the pan.
- Stir thick liquids occasionally.
- Food that needs to be seared quickly, or food which loses a lot of liquid during initial frying, is best seared in several small portions.
- When you cook with a lid on, turn the heat setting down as soon as steam escapes between lid and cookware.
- Keep the lid on the cookware after cooking until you serve the food.
- When you cook with a pressure cooker, observe the manufacturer's instructions.
- Do not cook food for too long or in too much water. Otherwise the nutrients will be lost. You can use the kitchen timer to set the optimum cooking time.
- Do not heat oil or grease until it smokes. You will achieve healthier cooking results.
- When you brown food, fry small portions one after the other.
- Cookware may become very hot during cooking. We recommend the use of pot holders.
- You can find recommendations for energy-efficient cooking under  
→ "Saving energy", Page 9

### ⚠ CAUTION

Stews or liquids can heat up very quickly during cooking and may overflow or spatter, e.g. soups, sauces or drinks.

- ▶ Stir continuously.
- ▶ Heat the food at a suitable power level.



**Melting**

<b>Food</b>	<b>Ongoing cooking setting</b>	<b>Cooking time in min.</b>
Chocolate, coating	1 - 1.5	-
Butter, honey, gelatin	1 - 2	-

**Heating or keeping warm**

<b>Food</b>	<b>Ongoing cooking setting</b>	<b>Cooking time in min.</b>
Stew, such as lentil stew	1.5 - 2	-
Milk	1.5 - 2.5	-
Heating sausages in water	3 - 4	-

**Defrosting and heating**

Spinach, frozen	3 - 4	15 - 25
Goulash, frozen	3 - 4	35 - 55

**Poaching and simmering**

Potato dumplings	4.5 - 5.5	20 - 30
Fish	4 - 5	10 - 15
White sauces, such as Béchamel sauce	1 - 2	3 - 6
Whisked sauces, such as Béarnaise sauce, Hollandaise sauce	3 - 4	8 - 12

**Boiling, steaming or braising**

Rice, with double the amount of water	2.5 - 3.5	15 - 30
Rice pudding	2 - 3	30 - 40
Unpeeled boiled potatoes	4.5 - 5.5	25 - 35
Peeled boiled potatoes with salt	4.5 - 5.5	15 - 30
Pasta	6 - 7	6 - 10
Stew	3.5 - 4.5	120 - 180
Soups	3.5 - 4.5	15 - 60
Vegetables	2.5 - 3.5	10 - 20
Vegetables, frozen	3.5 - 4.5	7 - 20
Stew in a pressure cooker	4.5 - 5.5	-

**Braising**

Rolled roasting joint	4 - 5	50 - 65
Pot roast	4 - 5	60 - 100
Goulash	3 - 4	50 - 60

**Braising or frying with a small amount of oil**

Cook without a lid.

Escalope, plain or breaded	6 - 7	6 - 10
Escalope, frozen	6 - 7	6 - 12
Chops, plain or breaded	6 - 7	8 - 12
Steak, 1¼" (3 cm) thick	7 - 8	8 - 12
Poultry breast, ¾" (2 cm) thick	5 - 6	10 - 20
Poultry breast, frozen	5 - 6	10 - 30

Rissoles, 1¼" (3 cm) thick	4.5 - 5.5	20 - 30
Hamburgers, ¾" (2 cm) thick	6 - 7	10 - 20
Fish and fish fillet, plain	5 - 6	8 - 20
Fish and fish fillet, breaded	6 - 7	8 - 20
Fish, breaded and frozen, such as fish sticks	6 - 7	8 - 15
Shrimp and scampi	7 - 8	4 - 10
Sautéing fresh vegetables and mushrooms	7 - 8	10 - 20
Asian stir fries, vegetables and pieces of meat	7 - 8	15 - 20
Stir fries, frozen	6 - 7	6 - 10
Pancakes, cooked one after the other	6.5 - 7.5	-
Omelette, cooked one after the other	3.5 - 4.5	3 - 10
Fried eggs	5 - 6	3 - 6

**Deep-fat frying**

5 - 7 oz (150-200 g) per portion in 2 - 4 pints (1-2 liters) oil, fried in portions.

Cook without a lid.

Frozen products, such as fries, chicken nuggets	8 - 9	-
Croquettes, frozen	7 - 8	-
Meat, such as chicken portions	6 - 7	-
Fish, breaded	6 - 7	-
Vegetables, mushrooms, breaded or tempura	6 - 7	-
Small baked items, e.g. donuts	4 - 5	-

**7.4 Dynamic cooking**

Use this function for cooking processes that require the power level to be changed frequently. This allows you to change the power level during cooking by moving the cookware forward or backward.

This function turns the entire cooking surface into a single cooking area with three different default power levels. Depending on the position of the cookware, the preset power level for this position is applied automatically. The cooking zone display shows the power level used for a particular piece of cookware.



Cooking surface section	Default power level
Front	9.0

Cooking surface section	Default power level
Middle	5.0
Rear	1.0

You can change the default power levels in the basic settings menu.

→ "Basic settings", Page 32

**Notes**

- The functions Power Boost, Pan Boost and Keep Warm are not available while dynamic cooking is active.
- While dynamic cooking is active, the other cooktop modes are not available.
- For more information on the size and positioning of the cookware, refer to the section on induction cooking.

**Activating dynamic cooking**

1. Place the cookware on the cooking surface.
  2. Touch to enter the cooktop mode menu.
  3. Touch to select dynamic cooking.
  4. Touch to confirm.
- ✓ The three default power levels are displayed on the display.
  - ✓ When you move cookware over the cooking surface, the cooktop automatically starts searching. The power level of the cooktop section on which the cookware has been detected is set automatically.

## Setting down the cookware

1. If you have already set a power level for a cookware before you activate this cooktop mode, the cooking zone display of this cookware does not show a power level. You have to confirm the power level that is assigned to the cooking surface section.
  - Touch the cooking zone display.
  - Touch ✓ to confirm.
2. If you place a new piece of cookware on the cooking surface, you have to confirm the assigned power level.
  - Touch the cooking zone display.
  - Touch ✓ to confirm.

**Note:** If the size of the cookware is not suitable for this function, ⊖ lights up on the cooking zone display. Touch ⊖ for more information. To return to the main screen, touch ✓.

## Changing the power level during dynamic cooking

You can change the preset power levels while you are cooking.

- ▶ Touch the area you want to change and set a different power level in the display.

**Note:** When you deactivate the function, the power levels return to the default values.

## Deactivating dynamic cooking

1. Touch □.
  2. Select a different cooktop mode and touch ✓ to confirm.
- ✓ The currently active power levels for each item of cookware are retained.

## 7.5 Professional cooking

Use this function for cooking processes that require the power level to be changed frequently. This allows you to change the power level during cooking by moving the cookware to the left or right.

This function turns the entire cooking surface into a single cooking area with three different default power levels. Depending on the position of the cookware, the preset power level for this position is applied automatically. The cooking zone display shows the power level used for a particular piece of cookware.

Cooking surface section	Default power level
Lef	1.5
Middle	9.0
Right	5.0

You can change the default power levels in the basic settings menu.

→ "Basic settings", Page 32

### Notes

- The functions Power Boost and Pan Boost are not available while professional cooking is active.

- While professional cooking is active, the other cooktop modes are not available.
- For more information on the size and positioning of the cookware, refer to the section on induction cooking.

## Activating professional cooking

1. Place the cookware on the cooking surface.
  2. Touch □ to enter the cooktop mode menu.
  3. Touch □ to select professional cooking.
  4. Touch ✓ to confirm.
- ✓ The three default power levels are displayed on the display.
  - ✓ When you move cookware over the cooking surface, the cooktop automatically starts searching. The power level of the cooktop section on which the cookware has been detected is set automatically.

## Setting down the cookware

1. If you have already set a power level for a cookware before you activate this cooktop mode, the cooking zone display of this cookware does not show a power level. You have to confirm the power level that is assigned to the cooking surface section.
  - Touch the cooking zone display.
  - Touch ✓ to confirm.
2. If you place a new piece of cookware on the cooking surface, you have to confirm the assigned power level.
  - Touch the cooking zone display.
  - Touch ✓ to confirm.

**Note:** If the size of the cookware is not suitable for this function, ⊖ lights up on the cooking zone display. Touch ⊖ for more information. To return to the main screen, touch ✓.

## Combining cooktop surface sections

The cooktop surface sections with the default power levels can be combined to form one large surface with the same power levels.

1. Touch one of the vertical edges of the middle section and swipe left or right to the end of the adjacent section.



- ✓ The combined area uses the power level of the section being expanded.

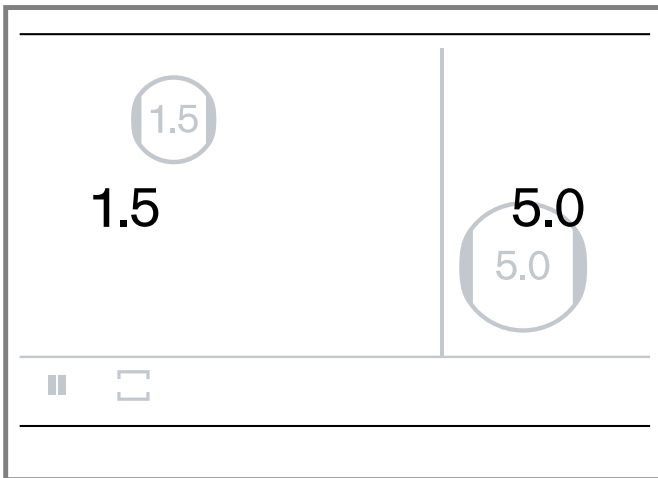

2. To separate the combined sections, touch one of the vertical edges of the area and swipe left or right, until the hidden section reappears.

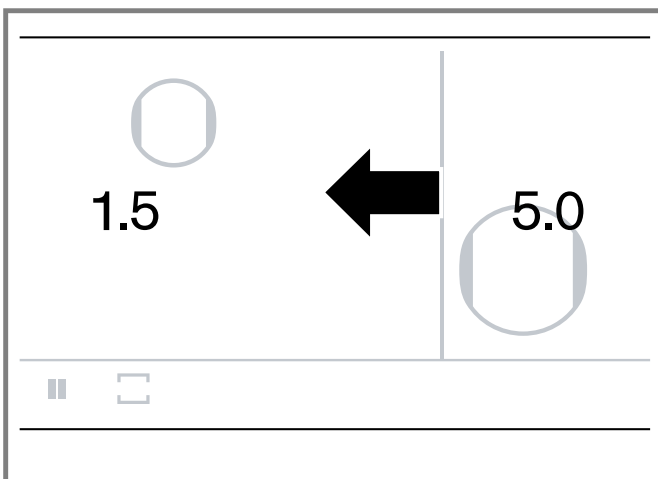



### Changing the power level during professional cooking

You can change the preset power levels while you are cooking.

- ▶ Touch the area you want to change and set a different power level in the display.

**Note:** When you deactivate the function, the power levels return to the default values.

### Deactivating professional cooking

1. Touch .
  2. Select a different cooktop mode and touch  to confirm.
- ✓ The currently active power levels for each item of cookware are retained.

### 7.6 Short-term timer

You can use the Short-term timer to set a time of up to 9 hours, 59 minutes and 59 seconds.

The Short-term timer is independent from other settings and does not switch off a cooking zone.



You can also use the Short-term timer function when the cooktop is turned off.

### Setting the Short-term timer

#### WARNING

Boilovers can cause smoke and some foods and oils may catch fire if left on high temperature settings.

- ▶ When using a timer, always supervise the cooktop.
- ▶ Do not allow anything to boil over or burn.

1. Press  to enter the timer menu.
  2. Touch .
  3. Touch  to confirm.
- ✓ 00 | 00:00 lights up on the display.
4. Within the next 10 seconds, scroll up or down to set the time in hours, minutes and seconds.

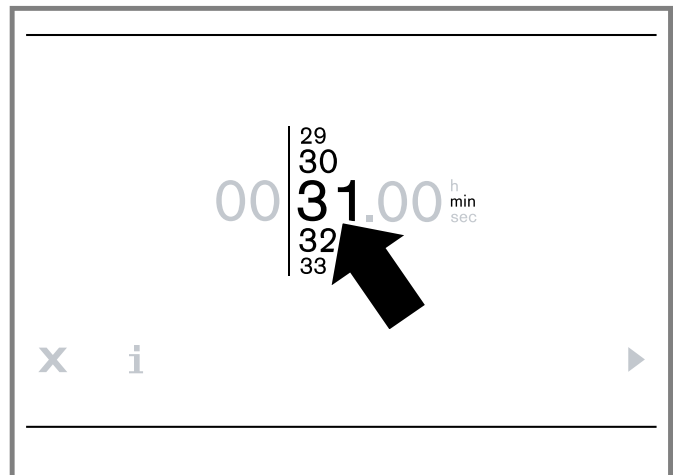

5. Touch ► to confirm.



- ✓ ⌘ and the selected time light up on the function bar.
  - ✓ The time starts to count down.
  - ✓ When the time has elapsed, a signal sounds. 00.00 blinks on the timer display.
6. Touch ⌘ to turn off the signals.

### Using the timer plus function

With the timer plus function you can determine how much time has elapsed since the Short-term timer has elapsed.

**Requirement:** The Short-term timer has run out and the timer end signal is still active.

1. Press and hold ⌘ for a few seconds.

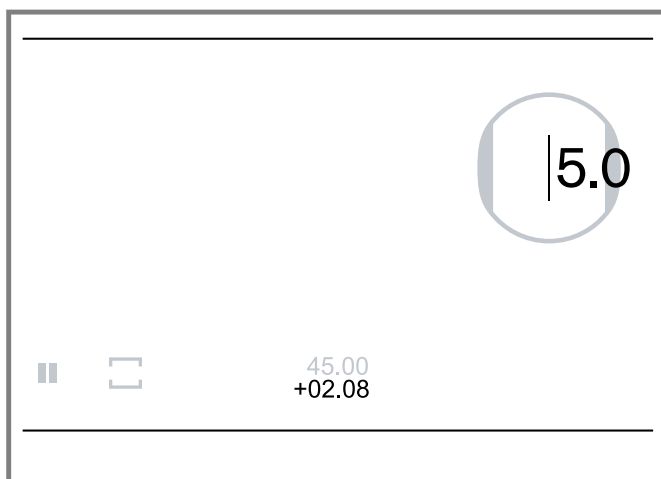

- ✓ The Stopwatch is activated and is shown on the timer display preceded by +.
  - ✓ The originally set Short-term timer value is also shown on the timer display.
2. To set a new value on the Short-term timer, touch the timer display.
  3. To turn off the timers, touch and hold the timer display for a few seconds.

### Pausing the Short-term timer

1. Touch ⌘.
  2. Touch ||.
- ✓ The timer pauses and is displayed on the main screen.
3. To continue the timer, touch ⌘ and then ► to confirm.

### Changing or canceling the Short-term timer

1. Touch ⌘.
2. Scroll up or down to change the time. Touch ► to confirm.
3. To cancel the timer, touch ■.
4. Touch X to exit the timer menu.

### 7.7 Stopwatch

The Stopwatch displays the time that has elapsed since activating the function.

The Stopwatch works independently from the cooking zones and from other settings. This function does not automatically switch off a cooking zone.

### Starting the Stopwatch

#### ⚠ WARNING

Boilovers can cause smoke and some foods and oils may catch fire if left on high temperature settings.

- ▶ When using a timer, always supervise the cooktop.
- ▶ Do not allow anything to boil over or burn.

1. Press ⊖ to enter the timer menu.
2. Touch ⌘.
3. Touch ► to start.

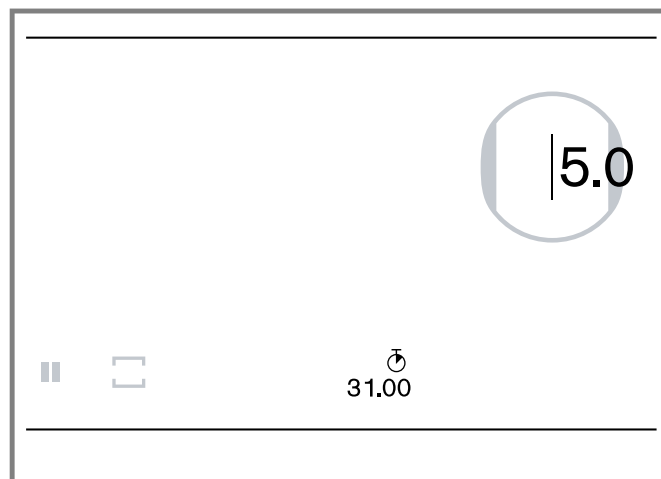

- ✓ 00 | 00:00 and ⌘ light up in the function bar.
- ✓ The timer starts to count up.

### Pausing the Stopwatch

1. Touch ⌘.
  2. Touch ||.
- ✓ The timer pauses and is displayed on the main screen.
3. To continue the timer, touch ⌘ and then ► to confirm.

### Canceling the Stopwatch

1. Touch ⌘.
  2. Touch ■.
- ✓ The timer is reset to 00.00 and is displayed on the main screen.
3. Touch X to exit the timer menu.

## 7.8 Booster function for pots

With this function you can heat larger quantities of water faster than with power level 9. This function temporarily increases the top output of the selected cooking zone.

### Restrictions for using the Booster function

This function is available for a maximum of one pot per side of the cooking surface.

You can set the function when >> is displayed on the cooking zone display.

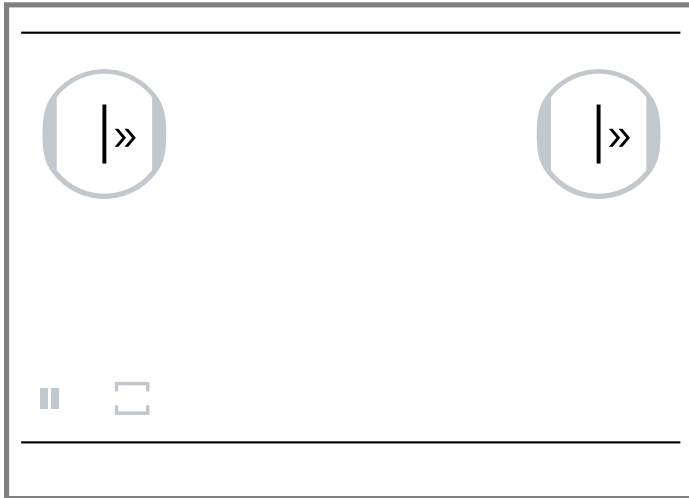

If the function is active and you select a second cooking position on the same side of the cooking surface, the function will be deactivated. The cooking position is automatically set to power level 9.0.

If the function is activated in the center of the cooking surface, you can make settings for other cookware on the left and right side of the cooking surface.

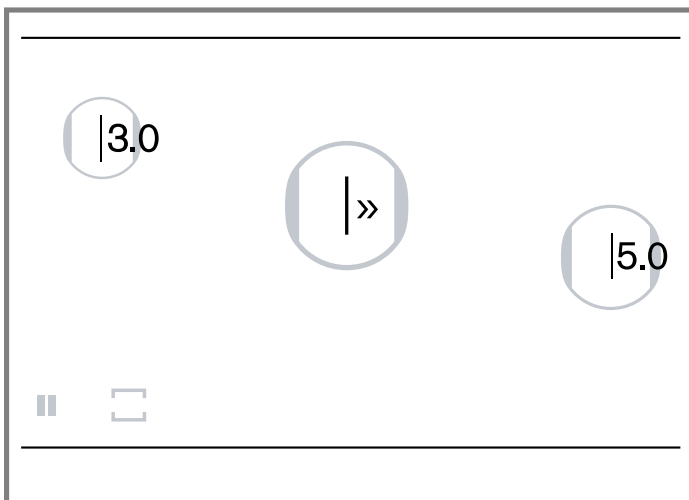

### Activating the Power Boost function

1. Touch the cooking zone symbol.
2. Touch >> in the cooking zone display.

### Deactivating the Power Boost function

1. Touch the cooking zone symbol and select any power level.
2. Scroll up or down to select >>.

## 7.9 Pan Boost function

With this function you can heat cookware faster than with power level 9.0.

Recommendations for using this function:

- Always use cookware that has not been pre-heated.
- Use cookware with a flat base.
- Do not use cookware with a thin base.
- Never leave empty cookware, oil, butter or lard to heat up unattended.
- Do not place a lid on the cookware.
- Refer to the information on cooking with induction for information on the type, size and positioning of the cookware.

### Restrictions for using the Pan Boost function

This function is available for a maximum of one pan at the same time.

You can set the function when >> is displayed on the cooking zone display.

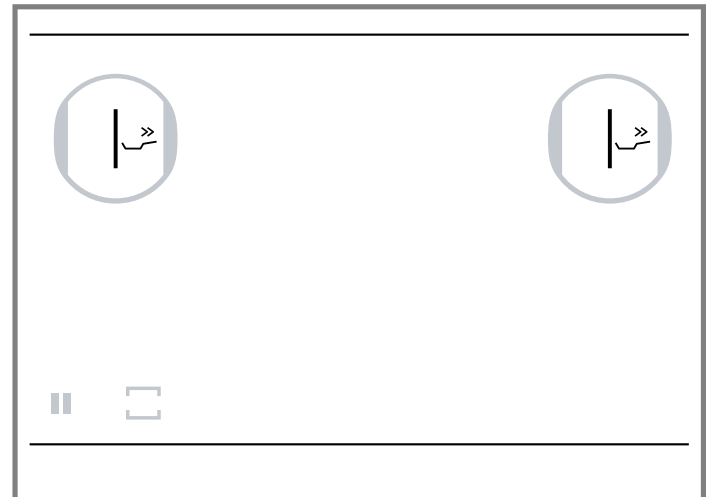

If the function is active and you select a second cooking position on the same side of the cooking surface, the function will be deactivated. The cooking position is automatically set to power level 9.0.

If the function is activated in the center of the cooking surface, you can make settings for other cookware on the left and right side of the cooking surface.

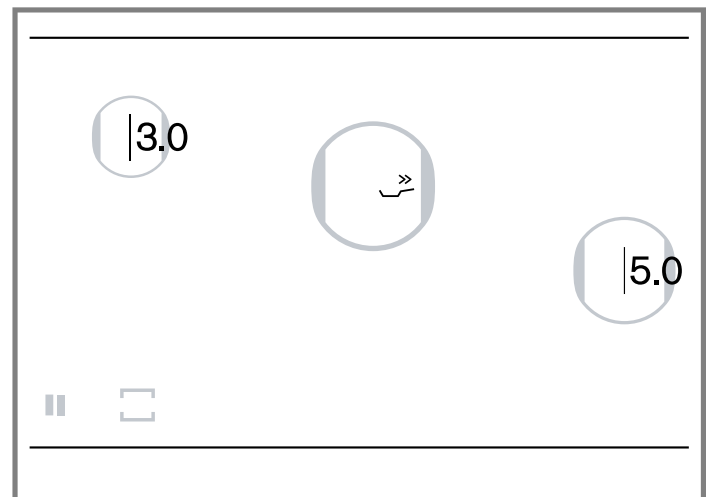



## Activating the Pan Boost function

### ⚠ WARNING

Oil and fat heat up quickly with the Booster for pans function. Overheated oil and fat may ignite.

- ▶ Never leave the cooktop unattended during cooking.

1. Touch the cooking zone symbol.
2. Touch  in the cooking zone display.

## Deactivating the Pan Boost function

The function is turned off automatically after 30 seconds. You can turn it off manually before that.

- ▶ Touch the cooking zone display and set any power level.

**Note:** If the function is turned off automatically, the cooking position is automatically set to power level 9.0.

## 7.10 Keep warm

This function is suitable for melting chocolate or butter and for keeping food warm.

### ⚠ CAUTION

Food might spoil when left standing for too long.

- ▶ To maintain food safety, do not keep food warm for more than one hour after cooking.

## Activating the keep warm function

1. Select the cooking zone.
2. Select power level 1.5 .

## Deactivating the keep warm function

1. Select the cooking zone.
2. Select any power level.

## 7.11 Transfer function

You can use this function to transfer the power level or temperature settings from one cooking zone to another. To transfer the settings, move the cookware from the cooking surface area you are using to another area. If you remove an item of cookware from the cooking surface or move it, the original cooking zone stops heating. The settings for the cooking zone are retained for 30 seconds.

When you set down the cookware in its original position, the settings are kept.

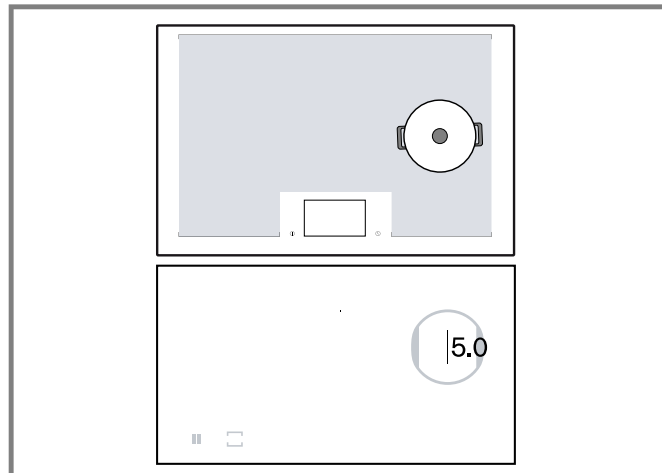

## Using the transfer function

1. The cookware is placed on a cooking zone and you have made settings.

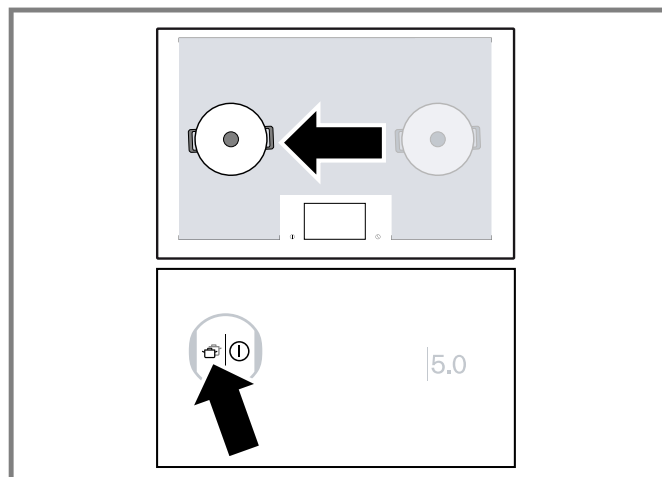

2. Lift the cookware from the active cooking zone and set it down on the new cooking zone.



- ✓  lights up on the new cooking zone display.
3. Touch  on the new cooking zone to confirm the transfer of settings.
  4. Select the new cooking zone to confirm the settings.
- ✓ The settings are transferred. The original cooking zone switches off.

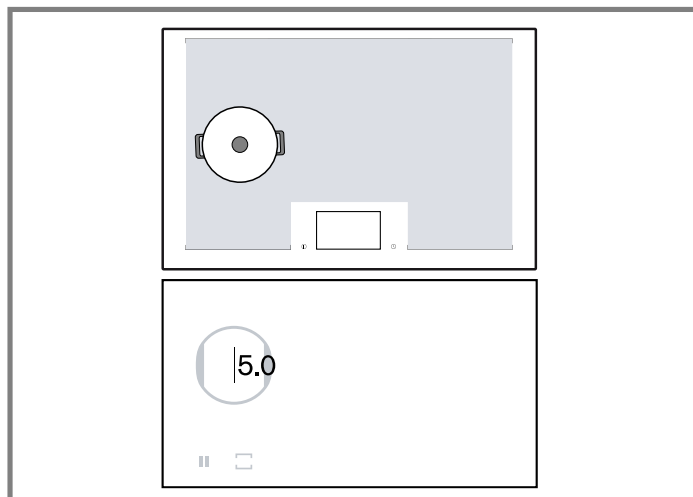

## 7.12 Cooking sensor mode

The cooking sensor processes make cooking easy and produce exceptional results.

How it works:

- A wireless cooking sensor is required to use this mode. → *"Wireless cooking sensor", Page 27*. The wireless cooking sensor forwards information about the temperature of the cookware to the control panel.
- The wireless cooking sensor measures the temperature of the cookware continuously. The power level is controlled and the right temperature is maintained at all times. This prevents overheating and ensures perfect results.
- Add your food once the selected temperature has been reached. The temperature is maintained automatically. You do not have to change the power level.
- The Cooking Sensor mode is available over the entire cooking surface.
- You can use up to three cooking sensors at the same time.

### Advantages when using the cooking sensor function

- The cooking zone only heats up in order to maintain the temperature. This saves energy. Oil or fat will not overheat.
- The temperature is continuously monitored. This prevents the food from spilling over and you do not need to change the temperature level.
- The cooking sensor mode informs you when the water or oil has reached the optimal temperature for adding the food; in some cases the food should be added at the beginning, refer to the cooking chart.

### General notes for using the cooking sensor function

- Use cookware with a thick, flat base. Do not use cookware with a thin or domed base.

- Fill the cookware so that the contents reach high enough to cover the cooking sensor's silicone patch.
- If you are frying with little oil using a frying pan, always use the frying sensor function.
- Position the cookware in such a way that the wireless cooking sensor is pointing towards the outer side of the cooktop.
- Do not remove the wireless cooking sensor from the cookware during cooking.
- Remove the wireless sensor from the cookware after cooking. Take care as you do so because the wireless cooking sensor can become very hot.
- Always cook with the lid on, except when you use the function for frying with a large amount of oil in the saucepan, 340°F (170°C).
- If no signal sounds, ensure that there is a lid on the container. For optimum operation of the cooking sensor, we recommend always using a lid, except when you use the function for deep-fat frying with a large amount of oil in a pot.
- Never leave oil unattended when it is being heated. Use oil that is suitable for deep-fat frying. Do not mix different cooking fats and oils, such as oil and lard. These mixtures may foam up when they become hot.
- If you are not satisfied with the cooking result use more water the next time, for example when boiling potatoes. Use the recommended temperature level.

### Suitable cookware for the cooking sensor function





- Use cookware that is tall enough that, when the required volume of water is added, the water level is higher than the silicone patch for the wireless cooking sensor.
- Any cookware that is suitable for induction cooking can be used for the cooking sensor. Refer to the information on induction cooking.



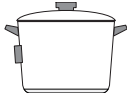

## Types of cooking processes with the cooking sensor function

You can use the cooking sensor function to select the best type of cooking for each kind of food.

The table shows the various function settings that are available when using the cooking sensor function.

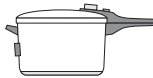
If there is no wireless cooking sensor included with your cooktop, you can purchase it from specialist retailer, Customer Service, or our official website.

Cooking process	Temperature levels °F (°C)	Cookware	Examples for use
Keeping warm, heating	155 (70)		Punch, joulash
Poaching in milk	185 (85)		Panna cotta, rice pudding
Poaching in water	195 (90)		Potato dumplings, rice, quinoa
Boiling	212 (100)		Pasta, gnocchi, vegetables

Cooking process	Temperature levels °F (°C)	Cookware	Examples for use
Cooking in a pressure cooker	240 (115)		Home-made broths, legumes
Deep-fat frying at a low temperature	320 (160)		Doughnuts, fritters
Deep-fat frying at a medium temperature	340 (170)		Breaded fish, dumplings
Deep-fat frying at a high temperature	355 (180)		Frozen French fries

### Tips for cooking with the cooking sensor mode

Here you can find recommendations on how to use the different cooking processes for cooking sensor mode.

#### Keeping warm/heating

- Suitable for portions of frozen products, such as spinach.
- Place the frozen product in the cookware.
- Add the volume of water specified by the manufacturer.
- Cover the cookware with a lid.
- Select the temperature recommended in the table.

#### Simmering

- Suitable for cooking food at low temperatures, thickening sauces, reducing stews and cooking with milk.
- Select the temperature recommended in the table for the food you want to cook.

#### Boiling

- Allows you to boil water with a lid on without boiling over.
- Allows water to be boiled more efficiently.
- Select the temperature recommended in the table.

#### Cooking in a pressure cooker

- Follow the manufacturer's recommendations.
- After the signal tone sounds, continue cooking for the recommended time.
- Select the temperature recommended in the table.

#### Deep-fat frying

- We recommended heating oil with a lid on.
- Once the signal tone has sounded, remove the lid and add the food.
- Select the temperature recommended in the table.

### Setting the boiling point

The point at which water starts to boil depends on the height of your home above sea level. If the water is boiling too vigorously or not vigorously enough, you can set the boiling point.



1. Touch  and select the basic setting for cooking sensor calibration.

2. The boiling point is set to 650 - 1300 ft (200 - 400 m) by default. If your home is at an elevation between 650 and 1300 ft (200 and 400 m) above sea level, there is no need to change the boiling point.

**Note:** The temperature level 212°F (100°C) is sufficient for efficient boiling, even if the water does not boil very quickly. However, you can change the boiling point. For example, if you want it to boil more quickly, you can select a lower altitude.

### Setting the cooking sensor function

**Requirement:** The cooktop is turned on.

1. Attach the wireless cooking sensor to the cookware.  
→ "Wireless cooking sensor", Page 27
2. Place a pot filled with sufficient liquid on the cooking zone and cover it with a lid.
3. Select the cooking zone.
4. Press  to select the cookware mode ①.
5. Scroll to select  ②.

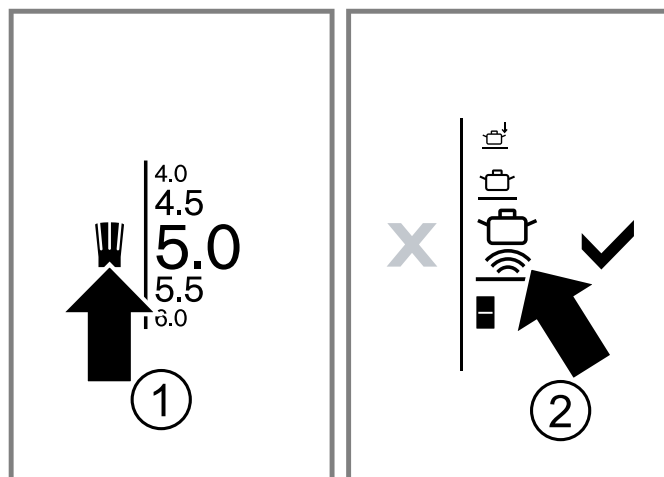

6. Press the  symbol on the wireless cooking sensor.

- Set the desired temperature on the cooking zone display.

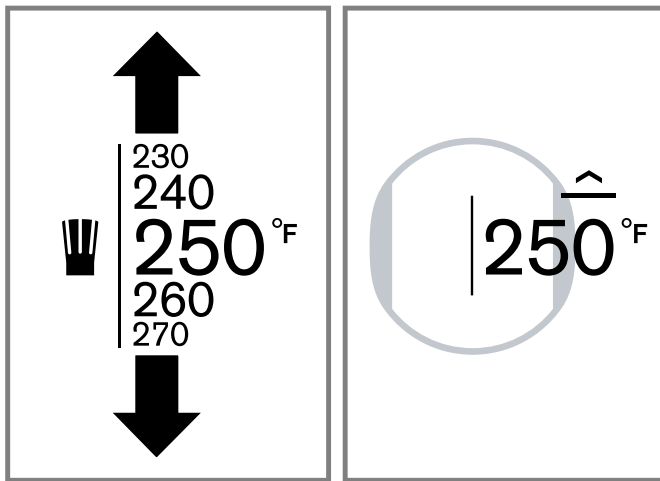



- ✓ The cooking zone starts to heat up. The heat-up indicator  lights up gradually in the cooking zone display.
- ✓ Once the set cooking temperature is reached, a signal sounds and the heat-up indicator goes out.

- Remove the lid after the signal tone and add the food. Keep the lid closed during the cooking process.

**Note:** When frying with a large amount of oil, do not cover the pot with a lid.

### Changing the temperature for the cooking sensor function

You can increase or decrease the temperature by 1 - 10°F (1 - 5°C) while cooking with the cooking sensor function.

- Touch the temperature setting in the cooking zone display.
- Touch .
- Select the desired temperature.
- Touch  to confirm.









### Turning the cooking sensor function off

- Touch the temperature setting in the cooking zone display.
- Touch to select a different cookware mode.
- Touch  to confirm.



## Cooking charts for the cooking sensor function

The following charts provide a selection of dishes and are sorted according to foods. Temperature and cooking time depend on the quantity, condition and quality of the foods.

### Meat

Food	Function	Temperature °F (°C)	Total cooking time from sound signal
<b>Poaching</b>			
Sausages		195 (90)	10-20
<b>Boiling</b>			
Meatballs		212 (100)	20-30
Stewing poultry		212 (100)	60-90
Viennese boiled beef		212 (100)	60-90
<b>Cooking with a pressure cooker</b>			
Stewing poultry		250 (115)	15-25
Viennese boiled beef		250 (115)	15-25
<b>Deep-fat frying</b>			
Deep-fat frying chicken portions		340 (170)	10-15
Deep-fat frying meatballs		340 (170)	10-15







### Fish

Food	Function	Temperature °F (°C)	Total cooking time from sound signal
<b>Poaching</b>			
Braised fish		195 (90)	15-20
<b>Deep-fat frying</b>			
Deep-fat frying fish in beer batter		340 (170)	340 (170)
Deep-fat frying breaded fish		340 (170)	10-15





**Egg dishes**

Food	Function	Temperature °F (°C)	Total cooking time from sound signal
<b>Boiling</b>			
Boiled eggs		212 (100)	5-10





**Vegetables and legumes**

Food	Function	Temperature °F (°C)	Total cooking time from sound signal
<b>Boiling</b>			
Broccoli		212 (100)	10-20
Cauliflower		212 (100)	10-20
Brussels sprouts		212 (100)	30-40
Green beans		212 (100)	15-30
Chickpeas		212 (100)	60-90
Peas		212 (100)	15-20
Lentils		212 (100)	45-60



**Cooking in a pressure cooker**

Vegetables in a pressure cooker		250 (115)	3-6
Chickpeas in a pressure cooker		250 (115)	25-35
White beans in a pressure cooker		250 (115)	25-35
Lentils in a pressure cooker		250 (115)	10-20





**Deep-fat frying**



















Deep-fat frying breaded vegetables		340 (170)	4-8
Deep-fat frying vegetables in beer batter		340 (170)	4-8
Deep-fat frying breaded mushrooms		340 (170)	4-8
Deep-fat frying mushrooms in beer batter		340 (170)	4-8

**Potatoes**

Food	Function	Temperature °F (°C)	Total cooking time from sound signal
<b>Poaching</b>			
Cooking potato dumplings		185 (85)	30-40
<b>Boiling</b>			
Boiling potatoes		212 (100)	30-45
<b>Cooking in a pressure cooker</b>			
Potatoes in a pressure cooker		250 (115)	10-20

**Pasta and cereals**

Food	Function	Temperature °F (°C)	Total cooking time from sound signal
<b>Poaching</b>			
Rice		195 (90)	25-35
Polenta		185 (85)	3-8
Semolina pudding		185 (85)	5-10
<b>Boiling</b>			
Pasta		212 (100)	7-10

Food	Function	Temperature °F (°C)	Total cooking time from sound signal
Dumplings		212 (100)	6-15
<b>Cooking in a pressure cooker</b>			
Rice in a pressure cooker		250 (115)	5-8
<b>Soups</b>			
Food	Function	Temperature °F (°C)	Total cooking time from sound signal
<b>Poaching</b>			
Instant creamy soups		195 (90)	10-15
<b>Hervir</b>			
Home-made broths		212 (100)	60-90
Instant soups		212 (100)	5-10
<b>Cooking in a pressure cooker</b>			
Home-made broths in a pressure cooker		250 (115)	20-30
<b>Desserts</b>			
Food	Function	Temperature °F (°C)	Total cooking time from sound signal
<b>Poaching</b>			
Rice pudding		185 (85)	40-50
Porridge		185 (85)	10-15
Chocolate pudding		185 (85)	3-5
<b>Boiling</b>			
Compote		212 (100)	15-25
<b>Deep-fat frying</b>			
Deep-fat frying jam-filled doughnuts		320 (160)	5-10
Deep-fat frying ring doughnuts		320 (160)	5-10
Deep-fat frying buñuelos		320 (160)	320 (160)
<b>Frozen products</b>			
Food	Function	Temperature °F (°C)	Total cooking time from sound signal
<b>Keeping warm, heating</b>			
Vegetables in cream sauce		160 (70)	160 (70)
<b>Boiling</b>			
Green beans, frozen		212 (100)	15-30
<b>Deep-fat frying</b>			
Deep-fat frying French fries		355 (180)	4-8
<b>Miscellaneous</b>			
Food	Function	Temperature °F (°C)	Total cooking time from sound signal
<b>Keeping warm, heating</b>			
Heating goulash soup		160 (70)	10-20
Heating mulled wine		160 (70)	5-15
<b>Poaching</b>			



Food	Function	Temperature °F (°C)	Total cooking time from sound signal
Heating milk		185 (85)	3-10

### 7.13 Wireless cooking sensor

Before you use the cooking functions for the first time, establish the connection between the wireless cooking sensor and the control panel.

#### Preparing and maintaining the wireless cooking sensor

This section provides you with the following information:

- Attaching the silicone patch
- Using the wireless cooking sensor
- Cleaning
- Replacing the battery

You can retroactively purchase the silicone patch and cooking sensor from specialist retailers, our technical customer service or our official website. When doing so, quote the relevant reference number:

00577921	Set of 5 silicone patches
CA060300	Cooking sensor and set of 5 silicone patches

#### Included in delivery

After unpacking all of the parts, check for any transport damage and for completeness of delivery.

- **A** Wireless cooking sensor
- **B** Silicone patch
- **C** Template

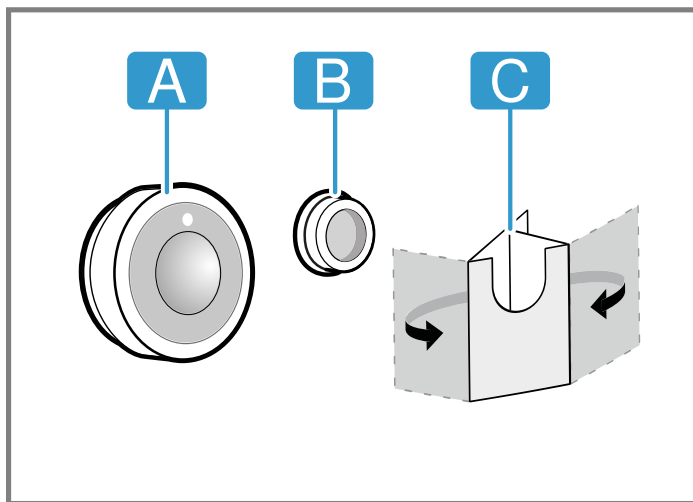

#### Attaching the silicone patch

The silicone patch secures the cooking sensor to the cookware. For fitting on the cookware:

1. The adhesive area on the cookware must be free from grease. Clean the cookware, dry it thoroughly and wipe the area where the patch is to be adhered using alcohol, for example.

2. Remove the protective film from the silicone patch. Adhere the silicone patch to the outside of the cookware in the correct place using the enclosed template as a guide.

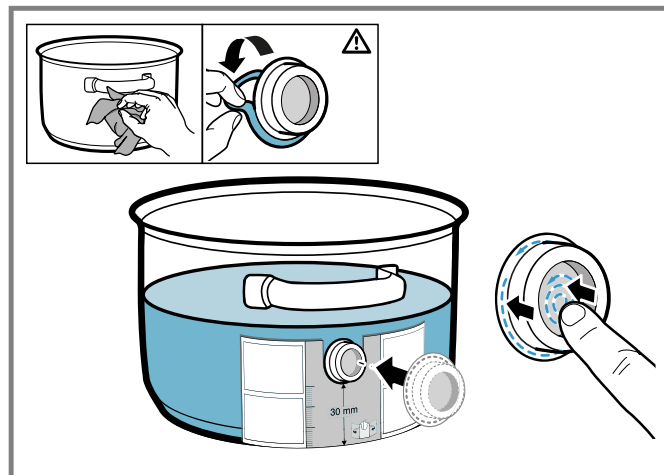

3. Press down all over the surface of the silicone patch, including in the center.
4. Leave the adhesive to dry for one hour. Do not use or rinse out the cookware during this time.

**Note:** If the silicone patch comes loose, use a new one. If required, you can purchase a set with five silicone patches from specialist retailers, from our customer service or on our official website [www.gaggenau.com](http://www.gaggenau.com) by quoting the article number 17007119.

All adhesives break down over time when they are stored. To prevent this, place the silicone bases on the relevant cookware as soon as you get them.



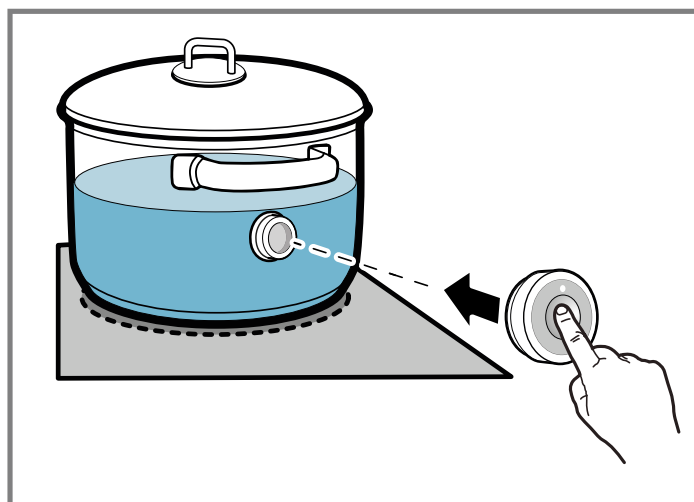

#### Attaching the wireless cooking sensor

1. Ensure that the silicone patch is completely dry before attaching the cooking sensor.
2. Place the cooking sensor squarely onto the silicone patch.





## Connecting the wireless cooking sensor to the control panel

The cooking functions are available as soon as the wireless cooking sensor has been connected to the control panel correctly.

1. Touch  in the function bar to enter the basic settings.
2. Select the setting  for cooking sensor pairing.
3. Touch .
4. Briefly touch the  symbol on the wireless cooking sensor within the next 30 seconds.

After a few seconds, the status of the connection between the cooking sensor and the control panel is indicated.



5. Touch .
6. To connect another cooking sensor, touch . To exit the basic settings, touch .
7. If the connection has failed, reset the wireless cooking sensor and repeat the connection procedure.  
→ "Resetting the wireless cooking sensor", Page 28
8. If there are problems with the connection due to a transmission error, repeat the connection procedure.
9. If no connection can be established, inform Customer Service.

### Note

The connection may not be established correctly for the following reasons:

- Bluetooth® communication error.
- You have not pressed the  symbol on the cooking sensor within 30 seconds after selecting the cooking zone.
- The battery in the wireless cooking sensor is almost flat.

## Resetting the wireless cooking sensor

1. Press and hold  for 8 to 10 seconds.
  - ✓ While you keep the touch key pressed, the LED indicator on the wireless cooking sensor lights up three times.
2. When the LED lights up for the third time, release the  touch key.
  - ✓ The reset procedure starts.
  - ✓ When the LED goes out, the wireless cooking sensor has been reset.
3. Repeat the connection process.

## Cleaning

### Cooking sensor

Clean with a damp cloth. Do not place in the dishwasher and do not get it wet.

When you are not using the cooking sensor, remove it from the cookware and store it in a clean, secure location, away from any heat sources.

### Silicone patch

Clean and dry before attaching the cooking sensor. Suitable for dishwashers.

**Note:** The cookware with the silicone patch must not be left to soak for long periods in soapy water.

## Window for the wireless cooking sensor

Always keep the window clean and dry. Important:

1. Remove dirt and oil splatters regularly.
2. For cleaning, use a cloth or cotton swab and window cleaning solution.

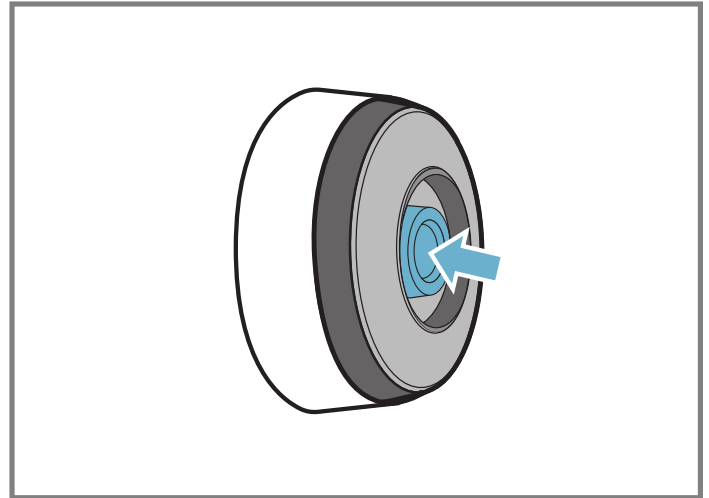

### Notes

- Do not use hard or rough objects such as bristle brushes or scouring pads to clean the cooktop, and do not use scouring agents.
- Do not touch the window for the wireless cooking sensor with your fingers; this will soil or scratch it.

## Replacing the battery

If the LED on the wireless cooking sensor does not light up when pressed, the battery is flat. Replacing the battery:

1. Remove the silicone cover from the lower section of the cooking sensor casing and remove both screws using a screwdriver.

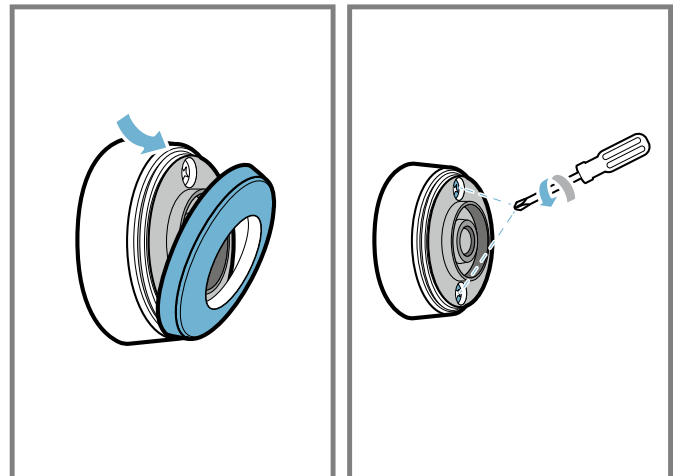

2. Open the cooking sensor cap and remove the battery from the base.

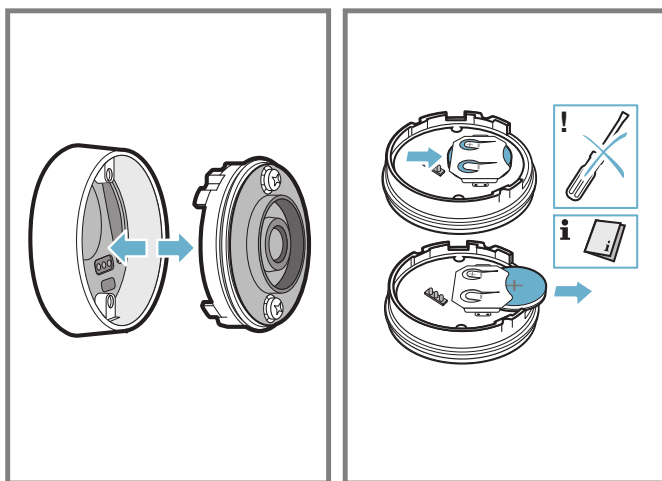

3. Insert a new battery, observing the instructions for the battery poles. Only use premium-quality CR2032 batteries.

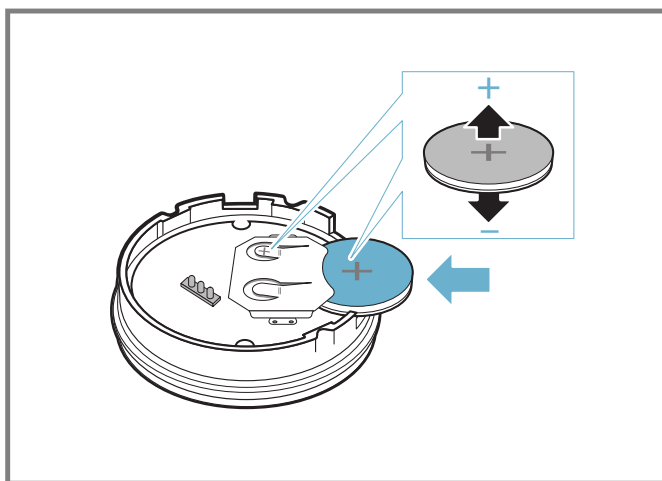

**Note:** Do not use any metal objects to remove the battery. Do not touch the battery terminals.

4. Close the cap on the cooking sensor. The indentations for the screws on the cap must be aligned with the indentations on the lower section of the casing. Use a screwdriver to tighten the screws and secure the silicone cover on the lower section of the cooking sensor casing.

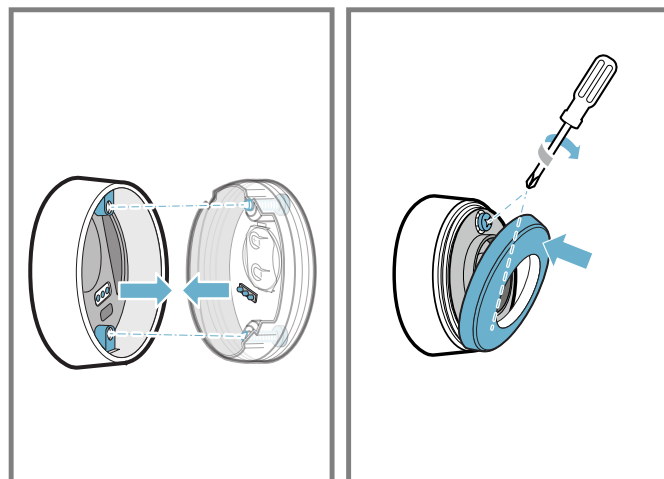

### Declaration of Conformity

BSH Home Appliances Corporation hereby declares that the appliance with wireless cooking sensor function meets the basic requirements and other relevant provisions of the Directive 2014/53/EU.

A detailed Declaration of Conformity in accordance with Directive RED can be found at [www.gaggenau.com](http://www.gaggenau.com) on the product page for your appliance under "Additional documents".

The logos and the Bluetooth® brand are registered trademarks and property of Bluetooth SIG, Inc. These trademarks are used by BSH Home Appliances Corporation under licence. All other marks and trade names are the property of the respective companies.

### 7.14 Single dynamic cooking



With this function, five default power levels are displayed when you place an item of cookware cooking surface. This allows you to change the power level during cooking by moving the cookware forward or backward.

The default power levels are 1.0, 3.0, 5.0, 7.0 and 9.0.

General information:

- You can change the default power levels in the basic settings menu.  
→ *"Basic settings", Page 32*
- If the function is not available in the settings area, the cookware may be too big. Use a smaller item of cookware.
- If the function does not activate when you select the power level, the appliance may have reached its maximum power consumption. Refer to the information on power management.  
→ *"Basic settings", Page 32*
- Refer to the information on cooking with induction for information on the type, size and positioning of the cookware.

### Activating single dynamic cooking

1. Place the cookware on the cooking surface.
2. Touch  to enter the cookware mode menu ①.
3. Scroll to select  to select dynamic cooking ②.

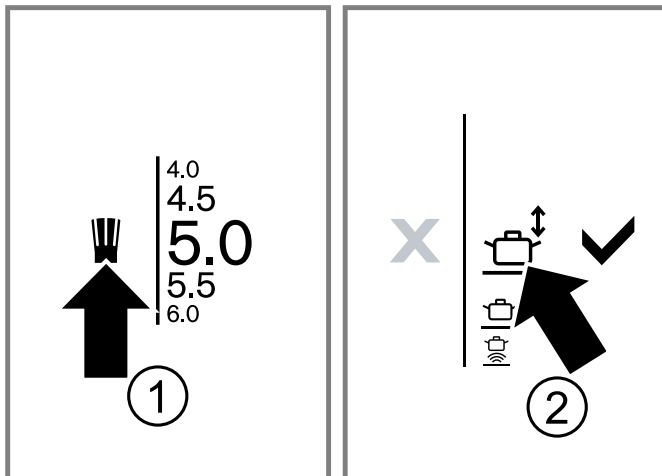

4. Touch  to confirm.
5. Move the cookware over the cooking surface until the power level you require is set. The power level you have selected will appear on the cooking zone display.

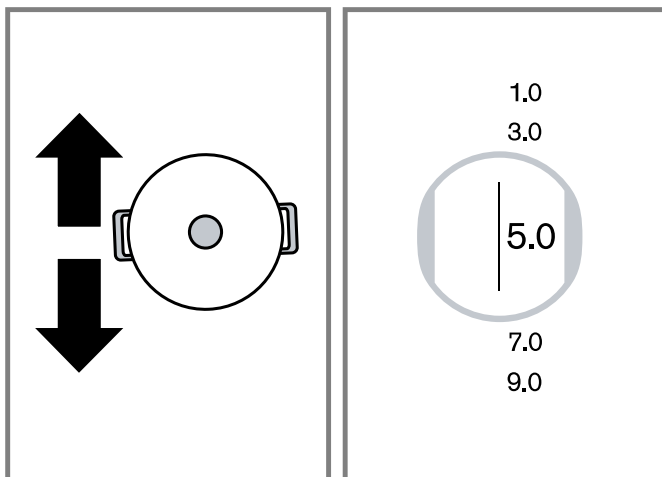



### Changing the power level during dynamic cooking

You can change the preset power levels while you are cooking.

- ▶ Touch the area you want to change and set a different power level in the display.

**Note:** When you deactivate the function, the power levels return to the default values.

### Deactivating single dynamic cooking

1. Touch the power level in the cooking zone display.
  2. Touch .
  3. Select a different cookware mode.
  4. Touch  to confirm.
- ✓ The function is deactivated. The active power level is retained.

## 7.15 Teppanyaki mode

This mode allows you to split the Teppanyaki grilling area into two halves: A hot area to which a heat setting is assigned, and an area to which no heat setting is assigned.

General information:

- You can change the heat settings during cooking.
- If the function is not available in the settings area, the cookware may be too big. Use a smaller item of cookware.

### Suitable cookware for Teppanyaki mode

There are Teppanyaki griddle plates that are perfectly suited for this mode.

You can order these parts as optional accessories from specialist retailers, Customer Service or through our official website. Always state the relevant reference number.

Reference number	Accessory
GN232110	Griddle style teppanyaki 13" x 21" (325 x 530 mm)
CA051300	Griddle style teppanyaki 10" x 16" (265 x 415 mm)

### Activating Teppanyaki mode

1. Place the cookware on the cooking surface horizontally or vertically.
2. Touch  to enter the cookware mode menu ①.

### 3. Scroll to select the required Teppanyaki setting ②.

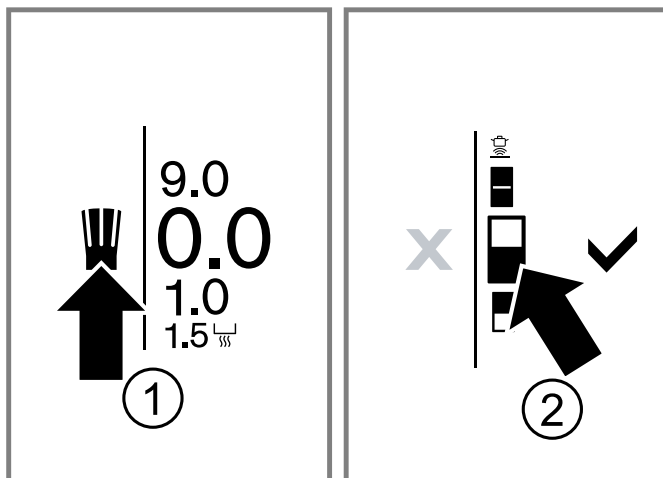

Depending on the position of the Teppanyaki griddle, one or more of the following settings are available:

Symbol	Position
	Vertical position, two areas warm
	Vertical position, bottom area warm
	Vertical position, top area warm
	Horizontal position, two areas warm
	Horizontal position, right area warm
	Horizontal position, left area warm

Touch ✓ to confirm.

- Select the power level in the cooking zone display.
- ✓ The display shows the orientation of the Teppanyaki griddle.
  - ✓ The display shows the power level for the entire cooking zone.
  - ✓ If you have selected a setting with only one warm area, the residual heat indicator is displayed in for the area with no power level.

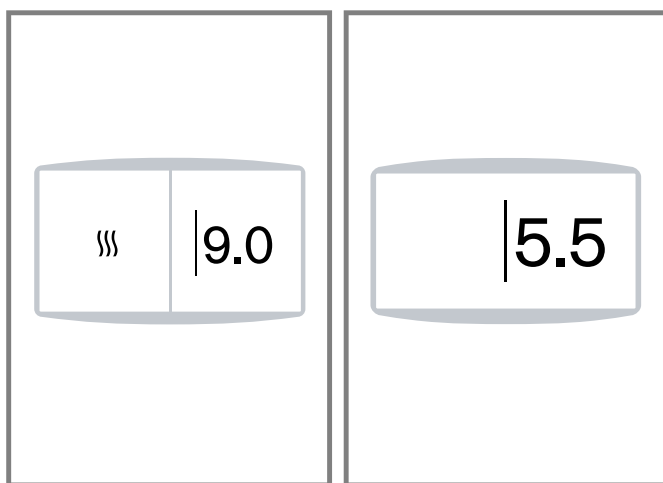

### Changing the power level during Teppanyaki mode

You can change the preset power levels while you are cooking.

- ▶ Touch the area you want to change and set a different power level in the display.

**Note:** If you change the orientation of the Teppanyaki griddle, select the appropriate setting for the new position on the cooking zone display.

### Deactivating Teppanyaki mode

- Touch the power level in the cooking zone display.
- Touch and select a different cookware mode.
- Touch ✓ to confirm.

### 7.16 Panel lock

You can use the panel lock to prevent the cooktop from being turned on accidentally.

#### Activating the panel lock

**Requirement:** The cooktop is turned on.

- ▶ Touch an hold for approximately 4 seconds.
- ✓ lights up.
- ✓ A signal sounds.
- ✓ The control panel is locked.

#### Deactivating the panel lock

**Requirement:** The cooktop is turned on.

- ▶ Touch an hold for approximately 4 seconds.
- ✓ lights up.
- ✓ A signal sounds.
- ✓ The control panel is unlocked.

### 7.17 Pause function

With the Pause function, you can interrupt a cooking process, for example to clean the control panel without changing any settings.

When you activate the pause function:

- All currently active settings light up on the display.
- The appliance pauses heating.
- If the Short-term timer or Stopwatch is set, it will continue running, but you cannot change the timer settings.
- The pause function has no effect on the main switch. You can turn off the cooktop at any time.

#### Activating the pause function

- ▶ Touch .
- ✓ The cooktop is locked for 30 minutes.
- ✓ is displayed in the function bar, only if a cooking process has been started.

#### Deactivating the pause function

- Touch .
  - Touch ✓.
- ✓ The cooking process is resumed.

#### Notes

















- If you do not continue cooking within 30 minutes, the cooktop turns off automatically.
- If you move cookware across the cooking surface while the pause function is active, the settings may be lost.

## 7.18 Basic settings

You can configure the basic settings for your appliance to meet your needs.

### Basic settings overview

Here you can find an overview of the basic settings and the preset factory settings.

Display	Setting	Options
	Brightness	Change the brightness of the touchscreen display.
	Start screen	Choose whether or not the brand logo will be displayed when you turn on the cooktop.
	Sounds	Select which signal tones you want the appliance to use.
kW	Power management	Restrict the total power of the appliance and adapt it to the local mains connection.
	Professional cooking - power levels	Change the default power levels of the cooking areas for professional cooking mode.
	Dynamic cooking - power levels	Change the default power levels of the cooking areas for dynamic cooking mode.
	Single dynamic cooking - power levels	Change the default power levels of the cooking areas for single dynamic cooking mode.
CAL	Cooking sensor calibration	Set your height above sea level to adjust the boiling point.
	Cooking sensor pairing	Connect the wireless cooking sensor to the cooktop.
	Temperature format	Change the temperature format.
	Language	Change the language used on the display.
	Start mode	Select the cooking mode that you want the cooktop to start with.
	Appliance index and production date	View information about your appliance.
	Automatic restore	Set how long the appliance saves the most recently used settings after it has been turned off.
	Presettings	Restore all settings to the factory settings.
	Panel lock	Set an automatic panel lock.
	Hood control	Control your hood from the cooktop. Connect the two appliances in the home network or by connecting the hood directly to the cooktop.
	Home Connect™	Connect the appliance to your home network and a mobile end device.

### Changing the basic settings

#### Requirements

- The cooktop is turned on.
- All cooking zones are deactivated.

1. Touch  to enter the basic settings menu.
- ✓ The first setting **Brightness** is displayed.

2. Swipe to the left or right to select the required setting.

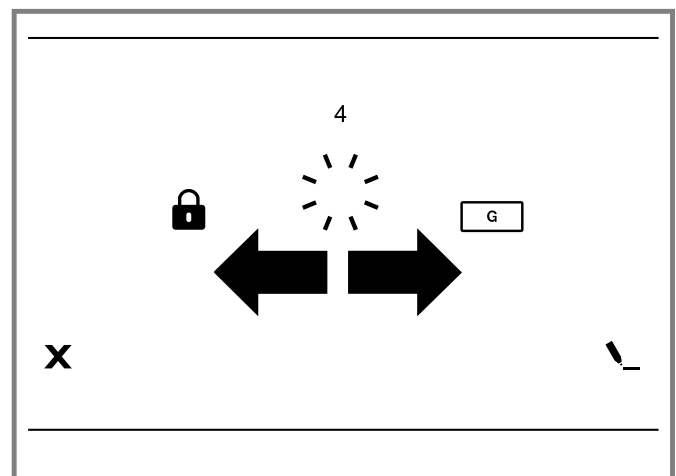





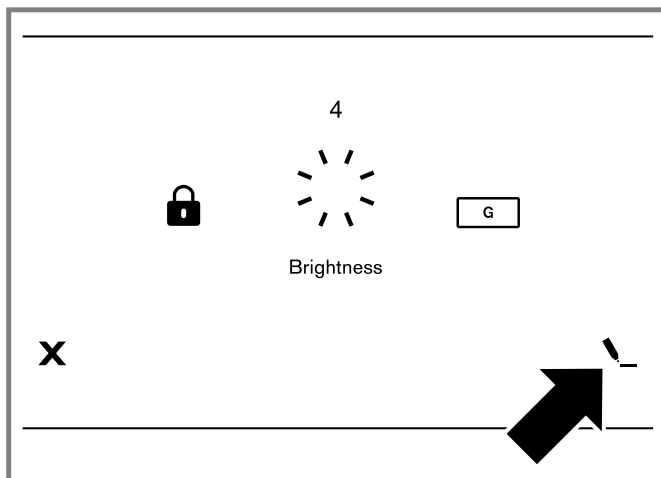

3. Touch  to change the selected setting.

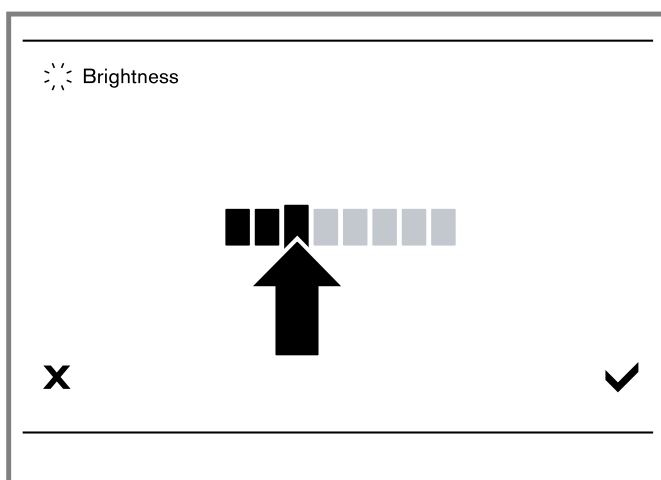

4. Change the selected settings.



5. Touch  to save the changes. To cancel and go back to the basic settings menu, touch .
6. Touch  to exit the basic settings.

## 8 Home Connect®

This appliance is network-capable. Connecting your appliance to a mobile device lets you control its functions via the Home Connect® app, adjust its basic settings and monitor its operating status.

The Home Connect® services are not available in every country. The availability of the Home Connect® function depends on the availability of Home Connect® services in your country. You can find information on this at: [www.home-connect.com](http://www.home-connect.com).

### 8.3 Overview of the Home Connect® settings

You can adjust the settings and network settings for Home Connect® by going to your cooktop's basic settings. The hob displays the setting "Connection" if the hob is not connected to the home network. All other settings are only displayed if the hob is already connected to the home network.

The Home Connect® app guides you through the entire registration process. Follow the instructions in the Home Connect® app to implement the settings.

**Tip:** Follow the instructions in the Home Connect® app as well.

#### Notes

- Also note the safety information in this instruction manual and ensure that it is also observed when operating the appliance using the Home Connect® app.
- Operating the appliance on the appliance itself always takes priority. It is not possible to operate the appliance using the Home Connect® app during this time.
- In networked standby mode, the appliance requires a maximum of 2 watts.
- Cooktops are not designed to be left unattended. Always monitor the cooking process.

### 8.1 Setting up the Home Connect® app

1. Install the Home Connect® app on your mobile device.
2. Start the Home Connect® app and set up access for Home Connect®.

The Home Connect® app guides you through the entire registration process.

### 8.2 Setting up Home Connect®

#### Requirements





- The appliance is connected to the power supply and is switched on.
- You have a mobile device with a current version of the iOS or Android operating system, e.g. a smartphone.
- The Home Connect® app is installed on your mobile device.
- The appliance receives signals from the WLAN home network (Wi-Fi) at its installation location.
- The mobile device and the appliance are within range of your home network's Wi-Fi signal.

1. Open the Home Connect® app and scan the following QR code.











2. Follow the instructions in the Home Connect® app.



Symbol	Setting	Description and options
	Connection	You can switch the Wi-Fi network on or off.
	Connecting to the app	You can connect the hob to one or more Home Connect® accounts.
	Setting via the app	You can set whether the cooking settings from the Home Connect® app can be sent to the hob.
	Deleting network settings	You can delete the saved connections to the home network.

## 8.4 Wi-Fi symbols

The Wi-Fi indicator on the main control panel changes depending on the status of the connection and the availability of the Home Connect® server.

Symb	Description
	The Wi-Fi home network is available and the settings in the Home Connect® app are activated.
	The Wi-Fi home network is available and the settings in the Home Connect® app are deactivated.
	The hob is not connected to the Home Connect® server and the settings in the Home Connect® app are activated.
	The hob is not connected to the Home Connect® server and the settings in the Home Connect® app are deactivated.
	The hob is not connected to the Wi-Fi home network and the settings in the Home Connect® app are activated.
	No Wi-Fi connection is available and the settings in the Home Connect® app are deactivated.
	Remote maintenance is carried out and a Wi-Fi connection is available.
	Remote maintenance is carried out and no Wi-Fi connection is available.

## 8.5 Changing settings via the Home Connect® app

You can use the Home Connect® app to change the settings for the cooking zones and send them to the cooktop.

### Requirements

- The cooktop is connected to the home network and to the Home Connect® app.
- In order to set the hob via the app, the basic setting "Setting via the app" must be switched on.

1. Select the setting in the Home Connect® app and send it to the hob.

Follow the instructions in the Home Connect® app.

- ✓ If cooking settings are transmitted to a cooking zone, the display shows a confirmation message.

2. Touch  to confirm the setting.

- ✓ If the setting was previously 0, a second confirmation message appears.

3. Touch  to confirm the setting.

## 8.6 Software update

Your appliance's software can be updated using the software update function, e.g. for the purposes of optimization, troubleshooting or security updates.

To do this, you must be a registered Home Connect® user, have installed the app on your mobile device and be connected to the Home Connect® server.

As soon as a software update is available, you will be informed via the Home Connect® app and will be able to start the software update via the app. Once the update has been successfully downloaded, you can start installing it via the Home Connect® app if you are in your home network (Wi-Fi). The Home Connect® app informs you once the installation is successful.

### Notes

- The software update consists of two steps.
  - The first step is the download.
  - The second step is the installation on your appliance.
- You can continue to use your appliance as normal while updates are downloading. Depending on your personal settings in the app, software updates can also be set to download automatically.
- Installation takes a few minutes. You cannot use your appliance during installation.
- We recommend that you install security updates as soon as possible.

## 8.7 Remote diagnostics

Customer Service can access your appliance via Remote Diagnostics if you ask them to do so, if your appliance is connected to the Home Connect® server and if Remote Diagnostics is available in the country where you are using the appliance.

**Tip:** Further information and details about the availability of Remote Diagnostics in your country can be found in the Service/Support section of your local website: [www.home-connect.com](http://www.home-connect.com).

## 8.8 Data Protection

Please read this information on data protection.

The first time your appliance is registered on a home network connected to the Internet, your appliance transmits the following types of data to the Home Connect® server (initial registration):

- Unique appliance identification (consisting of appliance codes as well as the MAC address of the installed Wi-Fi communication module).
- Security certificate of the Wi-Fi communication module (to ensure a secure data connection).
- The current software and hardware version of your home appliance.
- Status of any previous reset to factory settings.

This initial registration prepares the Home Connect® functions for use and is only required when you want to use the Home Connect® functions for the first time.

**Note:** Please note that the Home Connect® functions can only be used in conjunction with the Home Connect® app. Information on data protection can be retrieved in the Home Connect® app.

## 9 Hood Control

If both appliances are Home Connect® compatible, the easiest way to connect the appliances is in the Home Connect® app. To do this, connect the two appliances to Home Connect® and follow the instructions in the app.





### Notes

- If the appliance is being operated by means of the controls on the cooker hood, this mode of operation always has priority. It is not possible to use the hood controls on the cooktop during this time.
- You can only connect to the cooker hood via the Home Connect® app. Other connection routes are no longer supported.

### 9.1 Resetting the Home Connect® settings

If you have problems connecting your appliance to the WLAN home network (Wi-Fi) or if you want to log your appliance onto a different WLAN home network (Wi-Fi), you can reset the Home Connect® settings.

**Note:** If you reset the Home Connect® settings, the connection to any extractor hood will also be terminated.

1. Touch  to open the basic settings.
2. Navigate through the entries and touch the  "Hood control" setting.
3. Select  "Disconnect hood control" and press  to confirm.

## 9.2 Controlling the extractor hood via the cooktop

In the basic settings for your cooktop, you can adjust the behavior of your extractor hood depending on whether the cooktop or individual cooking zones are switched on or off. You can select other settings using the controls on the cooktop.

### Setting the fan

1. Touch  on the main screen.
2. Select a fan setting in the settings area.

You can select the following settings:

0	Fan off.
1, 2, 3	Fan settings: Low, Medium, High
>>	Intensive mode

Depending on the selected setting for the fan control, the following options are displayed:



A	Automatic mode
	Fan run-on
U	Unknown mode

- ✓ The selected setting fan setting appears on the main screen next to the  symbol.

### Switching off the fan

- ▶ Select fan setting 0.

### Switching on automatic mode

1. Touch  in the main screen.
  2. Select the  "Hood control" option.
  3. Select the **A** "Automatic" option.
- ✓ Depending on how the extractor hood sensor is configured, the fan will start automatically when the appliance detects smoke.



**Note:** You can find more information about this in the user manual for the extractor hood.

### Switching off automatic mode

1. Touch  in the main screen.
2. Select a different fan setting.

### Setting the hood lighting





You can switch the hood lighting on and off using the cooktop's control panel.

1. Touch  in the main screen.
  2. Select the  "Brightness" option.
  3. Select a brightness level.
- ✓ Depending on the basic settings you have selected, the light is automatically switched on or off when the cooktop is switched on or off.

## 9.3 Overview of the hood control settings

In the basic settings for your cooktop, you can adjust the behavior of your extractor hood depending on whether the cooktop or individual cooking zones are switched on or off.

The display shows the settings only when the appliance has been connected to the extractor hood.

Setting	Selection	Description
	Automatic control	You can set the fan setting at which the extractor hood starts when you switch on the cooktop.
	Run-on function	You can set whether and how the fan continues to run when you switch off the cooktop.
	Brightness	You can set the brightness at which the light for the extractor hood switches on automatically with the cooktop.
	Automatic light switch-off	You can set whether the light for the extractor hood switches off automatically with the cooktop.
	Disconnecting the hood control	With this setting, you reset the saved connections to the Wi-Fi or go back to the extractor hood.

## 10 Cleaning and maintenance

To keep your appliance working efficiently for a long time, it is important to clean and maintain it carefully.

### 10.1 Cleaning agents

You can purchase suitable cleaners and glass scrapers from Customer Support or in our online shop [www.gaggenau.com/zz/store](http://www.gaggenau.com/zz/store).

**Tip:** Gaggenau cleaners have been tested and approved for use on Gaggenau appliances. Other recommended cleaners do not constitute an endorsement of a specific brand.

#### Recommended cleaning agents

- Glass ceramic cooktop cleaner
- Gaggenau glass cooktop cleaner
- BonAmi®<sup>1</sup>
- Soft Scrub®<sup>1</sup> (without bleach)
- White vinegar

#### Unsuitable cleaning agents

- Glass cleaners which contain ammonia or chlorine bleach. These cleaners may damage or permanently stain the cooktop.
- Caustic cleaners such as Easy Off®<sup>1</sup>. These cleaners may stain the cooktop surface.
- Abrasive cleaners.
- Metal scouring pads and scrub sponges such as Scotch Brite®<sup>1</sup>. These cleaners may scratch the cooktop surface and/or leave metal marks.

- Soap-filled scouring pads such as SOS®<sup>1</sup>. These cleaners may scratch the cooktop surface.
- Powdery cleaners containing chlorine bleach. These cleaners may permanently stain the cooktop surface.
- Flammable cleaners such as lighter fluid or WD-40®<sup>1</sup>.

### 10.2 Cleaning the glass ceramic cooktop

#### WARNING

Clean Cooktop With Caution.

- ▶ If a wet sponge or cloth is used to wipe spills on a hot cooking area, be careful to avoid steam burn.
- ▶ Some cleaners can produce noxious fumes if applied to a hot surface.
- ▶ Do not clean the appliance while it is still hot.

#### CAUTION

Do not use any kind of cleaner on the glass while the surface is hot; use only the glass scraper. The resulting fumes can be hazardous to your health. Heating the cleaner can chemically attack and damage the surface.

#### Requirements

- The cooktop has cooled off.
  - Exception: Remove dry sugar, sugar syrup, milk and tomato products immediately.  
→ "Cleaning recommendations", Page 37
1. Wipe off splatters with a clean, damp sponge or a paper towel.
  2. Rinse and dry.
  3. If a smudge remains use white vinegar.

<sup>1</sup> These marks are registered trademarks of their respective owners. All other trademarks are trademarks of BSH Home Appliances Corporation or its affiliated companies.

4. Rinse and dry again.
5. Apply a small amount of cooktop cleaner with a clean paper towel or cloth and let it dry.
6. Buff the surface with a clean paper towel or cloth.

### 10.3 Cleaning the cooktop frame

For models with a metal frame follow these cleaning instructions.

#### Notes

- Wipe the cooktop frame with the grain.
  - For moderate to heavy soil, use BonAmi®<sup>1</sup> or Soft Scrub®<sup>1</sup> (no bleach).
1. Wipe using a damp sponge or cloth.
  2. Rinse and dry.

### 10.4 Cleaning recommendations

Follow these cleaning instructions for removing common soiling.

#### WARNING

The blade of the glass scraper is extremely sharp. You can cut yourself.

- ▶ Replace the blade immediately, when you see any imperfections.
- ▶ Follow the manufacturer's instructions.

#### NOTICE:

Diamond rings may scratch the ceramic cooktop surface.

- ▶ Take off any rings before you clean the ceramic cooktop surface.

Type of soil	Recommendation
<ul style="list-style-type: none"> <li>■ Dry sugar</li> <li>■ Sugar syrup</li> <li>■ Milk</li> <li>■ Tomato spills</li> <li>■ Melted plastic film or foil</li> </ul>	<p>REMOVE IMMEDIATELY. Failure to remove these substances immediately can permanently damage the ceramic cooktop surface.</p> <p>Remove the soil with the glass scraper while the cooktop surface is still hot.</p> <p>Use a new, sharp razor in the glass scraper.</p> <ul style="list-style-type: none"> <li>■ Remove the cookware and turn off the cooking zone.</li> <li>■ Put on an oven mitt.</li> <li>■ Hold the glass scraper at 30° angle and scrape off the soil. Be careful not to gouge or scratch the glass ceramic surface.</li> </ul>

<sup>1</sup> These marks are registered trademarks of their respective owners. All other trademarks are trademarks of BSH Home Appliances Corporation or its affiliated companies.

Type of soil	Recommendation
	<ul style="list-style-type: none"> <li>■ Push the soil off the heated area.</li> <li>■ Let the surface cool.</li> <li>■ Remove the residue and apply glass ceramic cooktop cleaner.</li> </ul>
<ul style="list-style-type: none"> <li>■ Burned-on food soil</li> <li>■ Dark streaks</li> <li>■ Dark specks</li> </ul>	<ul style="list-style-type: none"> <li>■ Lay a damp paper towel or sponge on top of the soil for 30 minutes to soften the soil.</li> <li>■ Remove the soil with a plastic scrubber and glass ceramic cooktop cleaner or with the glass scraper.</li> <li>■ Rinse the cooktop surface and dry it.</li> </ul>
Greasy spatters	<ul style="list-style-type: none"> <li>■ Remove grease with a soapy sponge or cloth.</li> <li>■ Rinse the cooktop surface thoroughly and dry it.</li> <li>■ Apply glass ceramic cooktop cleaner.</li> </ul>
Metal marks: iridescent stain	<p>Pans with aluminum, copper or stainless steel bases may leave marks.</p> <p>Treat metal marks immediately after the cooktop surface has cooled off. Failure to do so makes removal very difficult.</p> <ul style="list-style-type: none"> <li>■ Clean the cooktop surface with glass ceramic cooktop cleaner.</li> <li>■ If this does not remove the marks, clean the cooktop surface with a damp paper towel and a mild abrasive (Bon Ami®<sup>1</sup>, Soft Scrub®<sup>1</sup> without bleach).</li> <li>■ Rinse the cooktop surface and apply glass ceramic cooktop cleaner.</li> </ul>
Hard water spots	<p>Hot cooking liquids may drip or spill on the cooktop surface. The minerals in some water can be transferred onto the surface and cause stains.</p> <p>Remove boilovers and stains before using the cooktop again.</p> <ul style="list-style-type: none"> <li>■ Clean the cooktop surface with undiluted white vinegar.</li> <li>■ Rinse the cooktop surface and dry it.</li> </ul>

<sup>1</sup> These marks are registered trademarks of their respective owners. All other trademarks are trademarks of BSH Home Appliances Corporation or its affiliated companies.

<sup>1</sup> These marks are registered trademarks of their respective owners. All other trademarks are trademarks of BSH Home Appliances Corporation or its affiliated companies.

Type of soil	Recommendation
	<ul style="list-style-type: none"><li>■ Apply glass ceramic cooktop cleaner.</li></ul>
Surface scratches	<p>Small scratches are common and do not affect cooking. They become smoother and less noticeable with daily use of the glass ceramic cooktop cleaner.</p> <ul style="list-style-type: none"><li>■ Apply glass ceramic cooktop cleaner before cooking to remove sand-like grains and grit such as salt and seasoning.</li><li>■ Scratches can be reduced by using pans with bases that are smooth, clean, and dry before use. Use recommended glass ceramic cooktop cleaner daily.</li></ul>

---

<sup>1</sup> These marks are registered trademarks of their respective owners. All other trademarks are trademarks of BSH Home Appliances Corporation or its affiliated companies.

---

## 10.5 Maintenance

This appliance requires no maintenance other than daily cleaning.

For best results, apply cooktop cleaning cream daily.

# 11 Troubleshooting

You can eliminate minor issues on your appliance yourself. Please read the information on eliminating issues before contacting Customer Service. This may avoid unnecessary repair costs.

**⚠ WARNING**

Improper repairs are dangerous.

- ▶ Repairs to the appliance should only be performed by authorized service providers.

- ▶ Only original spare parts may be used to repair the appliance.
- ▶ If the power cord of this appliance becomes damaged, it must be replaced by the manufacturer, the manufacturer's Customer Service, or an authorized service provider in order to prevent injury.

## 11.1 Warnings

**Notes**

- If *E* appears in the displays, press and hold the sensor for the respective cooking zone and read the fault code.
- If the fault code is not listed in the table, disconnect the cooktop from the power supply and wait 30 seconds before reconnecting it. If this display appears again, contact our technical customer service and specify the exact fault code.
- If an error occurs, the appliance does not switch to standby mode.
- In order to protect the appliance's electronic parts from overheating or surge currents, the cooktop may temporarily reduce the power level.

Issue	Cause and troubleshooting
The cooktop does not turn on.	<p>The power supply has been disconnected.</p> <ul style="list-style-type: none"> <li>▶ Check whether the lighting in your kitchen or other appliances in the room are working.</li> </ul> <hr/> <p>The appliance has not been connected as shown in the circuit diagram.</p> <ol style="list-style-type: none"> <li>1. Disconnect the appliance from the power supply.</li> <li>2. Make sure the appliance has been connected as shown in the circuit diagram.</li> </ol> <hr/> <p>There is an electronics fault</p> <ul style="list-style-type: none"> <li>▶ If the fault cannot be eliminated, call Customer Service.</li> </ul>
The touchscreen display is not responding or has frozen.	<p>The control panel is damp or there is something on it.</p> <ul style="list-style-type: none"> <li>▶ Dry the control panel or remove the object.</li> </ul>
The power level of a cooking zone cannot be increased.	<p>Very large items of cookware may affect the maximum power level for the cooking surface area used.</p> <ul style="list-style-type: none"> <li>▶ Reposition the cookware.</li> </ul>
A signal tone sounds.	<p>There is an object on the touchscreen display.</p> <ol style="list-style-type: none"> <li>1. Remove any objects from the control panel and touchscreen display.</li> <li>2. Do not place hot cookware on the control panel.</li> </ol>
The cooktop responds in an unusual manner or cannot be operated properly.	<p>There is an electronics fault</p> <ol style="list-style-type: none"> <li>1. Disconnect the appliance from the power supply.</li> <li>2. Wait a couple of seconds and reconnect the appliance to the power supply.</li> <li>3. If the message persists, call Customer Support.</li> </ol>
A cooking zone has switched off automatically.	<p>The electronics have overheated. The corresponding cooking zone has switched off.</p> <ol style="list-style-type: none"> <li>1. Wait until the electronics have cooled down sufficiently.</li> <li>2. Touch any control element.</li> </ol> <p>✓ When error message disappears, the electronics have cooled down sufficiently. You can continue to cook.</p> <hr/> <p>There is hot cookware near the control panel. The cooking zone has switched off to protect the electronics.</p> <ol style="list-style-type: none"> <li>1. Remove the cookware from the control panel.</li> <li>2. Wait a few seconds.</li> </ol>



Issue	Cause and troubleshooting
A cooking zone has switched off automatically.	<p>3. Touch any control element.</p> <ul style="list-style-type: none"> <li>✓ When error message disappears, the electronics have cooled down sufficiently. You can continue to cook.</li> </ul>
All cooking zones have switched off automatically.	<p>The electronics have overheated. All cooking zones have switched off.</p> <ol style="list-style-type: none"> <li>1. Wait until the electronics have cooled down sufficiently.</li> <li>2. Touch any control element.</li> </ol> <ul style="list-style-type: none"> <li>✓ When error message disappears, the electronics have cooled down sufficiently. You can continue to cook.</li> </ul>
The transfer function cannot be activated.	<p>The original cookware has been removed from its position, and a cookware of a different size has been put in its place.</p> <ol style="list-style-type: none"> <li>1. Acknowledge the fault code by touching any touch key.</li> <li>2. Test the transfer function by setting down the original item of cookware.</li> <li>3. If the issue persists, call Customer Support.</li> <li>4. You can cook as usual without using the transfer function.</li> </ol>
The cooktop stops heating. A message is shown on the display	<p>The cooking zone has been operating continuously for an extended period of time without interaction. The automatic time limitation has been triggered.</p> <ul style="list-style-type: none"> <li>▶ Touch ✓.</li> <li>✓ You can set the cooking zone.</li> </ul>
The cooking position has been switched off. <i>E8202</i> is displayed.	<p>The cooking sensor has overheated.</p> <ol style="list-style-type: none"> <li>1. Wait until the cooking sensor has cooled down.</li> <li>2. Activate the cooking sensor function again.</li> </ol>
All cooking position adjacent to the cooking sensor have been switched off. <i>E8203</i> is displayed.	<p>The cooking sensor has overheated.</p> <ol style="list-style-type: none"> <li>1. If you are not using the cooking sensor function, remove the wireless cooking sensor from the cookware and keep it away from the cooking zones and other heat sources.</li> <li>2. Turn the cooking zone back on.</li> </ol>
<i>E8204</i> is displayed.	<p>The battery of the wireless cooking sensor is almost drained.</p> <ul style="list-style-type: none"> <li>▶ Replace the 3 V CR2032 battery. → <i>"Wireless cooking sensor", Page 27</i></li> </ul>
<i>E8205</i> is displayed.	<p>The connection to the cooking sensor is lost.</p> <ul style="list-style-type: none"> <li>▶ Deactivate the cooking sensor function and activate it again.</li> </ul>
<i>E8206</i> is displayed.	<p>The wireless cooking sensor is faulty.</p> <ul style="list-style-type: none"> <li>▶ Inform Customer Support.</li> </ul>
The cooking sensor symbol does not light up and the wireless cooking sensor is not responding.	<p>The battery of the wireless cooking sensor is almost drained.</p> <ul style="list-style-type: none"> <li>▶ Replace the 3 V CR2032 battery. → <i>"Wireless cooking sensor", Page 27</i></li> </ul> <p>The connection to the cooking sensor is lost.</p> <ol style="list-style-type: none"> <li>1. Press and hold the symbol on the wireless cooking sensor for 8-10 seconds.</li> <li>2. Reconnect the wireless cooking sensor to the cooktop. → <i>"Wireless cooking sensor", Page 27</i></li> <li>3. If the problem persists, call Customer Support.</li> </ol>
The cooking sensor indicator flashes twice.	<p>The battery of the wireless cooking sensor is almost drained.</p> <ul style="list-style-type: none"> <li>▶ Replace the 3 V CR2032 battery. → <i>"Wireless cooking sensor", Page 27</i></li> </ul>
The cooking sensor indicator flashes three times.	<p>The connection to the cooking sensor is lost.</p> <ol style="list-style-type: none"> <li>1. Press and hold the symbol on the wireless cooking sensor for 8-10 seconds.</li> <li>2. Reconnect the wireless cooking sensor to the cooktop. → <i>"Wireless cooking sensor", Page 27</i></li> <li>3. If the problem persists, call Customer Support.</li> </ol>



Issue	Cause and troubleshooting
E7010 is displayed.	<p>The cooktop is unable to connect to your home network or to the hood.</p> <ol style="list-style-type: none"> <li>1. Switch the appliance off and on again.</li> <li>✓ If the fault was a one-off occurrence, the message disappears.</li> <li>2. If the message appears again, call Customer Service. Please specify the exact error message when calling. → "Customer Service", Page 44</li> </ol>
E9000 / E9010	<p>The supply voltage is incorrect. It is outside the normal operating range.</p> <ul style="list-style-type: none"> <li>▶ Contact your electrical utility provider.</li> </ul>
The cooking zones do not heat up. ✘ is displayed.	Demo mode is activated.

## 11.2 Normal noises from your appliance

An induction cooktop may sometimes cause noises or vibrations, such as buzzing, crackling, hissing noises, fan noises, or rhythmic noises.

## 11.3 Cookware test

The quality of the cookware affects the speed and the result of the cooking process.

You can use this function to test the quality of the cookware.

Before the test, ensure that the size of the cookware base corresponds to the size of the cooking zone being used.

Access is via the basic settings. → Page 32

### Running Cookware test

As a single cooking zone, the flexible cooking zone is set in such a way that only the individual item of cookware is checked.

1. At room temperature, place the cookware with approximately 200 ml water in the center of the cooking zone that best fits the base of the cookware in terms of size.
  2. Call up the basic settings and select the "Test cookware" option.
  3. Follow the instructions on the display panel.
- ✓ After 10 seconds, the result appears in the cooking zone displays.

**Note:** To activate the function, return to the basic settings and select Cookware test.

## 12 Disposal

### 12.1 Disposal of your old appliance

Environmentally compatible disposal allows valuable raw materials to be recycled.

- ▶ Dispose of the appliance in an environmentally responsible manner.

Information about current disposal methods can be obtained from your specialist dealer or local authority.

## 13 FAQs

### 13.1 Using the appliance

question	Answer
No image appears on the display panel.	<ul style="list-style-type: none"> <li>▪ The brightness is not set correctly. Look at the the display from above and set the brightness in the basic settings. You can find additional information about this setting in the section entitled → "<i>Basic settings</i>", Page 32.</li> </ul>
The main display shows a warning message and a signal tone sounds.	<ul style="list-style-type: none"> <li>▪ Remove any liquid or food remains from the control panel. Remove any objects from the control panel. You can find out how to deactivate the audible signal in the "Basic settings" section. → Page 32</li> </ul>

### 13.2 Noises

question	Answer
Why I can hear noises while I'm cooking?	<ul style="list-style-type: none"> <li>▪ Noises may be generated while using the cooktop depending on the properties of the base of the cookware. These noises are normal for induction technology. They do not indicate that there is a fault.</li> </ul>
Possible noises	<ul style="list-style-type: none"> <li>▪ <b>A deep humming noise similar to a transformer:</b> Occurs when cooking at a high power level. This noise disappears or becomes quieter when you reduce the power level.</li> <li>▪ <b>A deep hum:</b>The cookware may be too small or not suitable for induction cooking. Move the cookware to a different position on the cooking surface or use a larger item of cookware.</li> <li>▪ <b>A quiet whistling noise:</b> This can be heard when the cookware is empty. This noise disappears when you add water or food to the cookware.</li> <li>▪ <b>Crackling:</b> This noise occurs when the cookware is made from different multilayer materials, or if you use cookware of different sizes and different materials. The volume of the noise can vary depending on the quantity of food being cooked or the cooking method.</li> <li>▪ <b>Loud whistling noises:</b> These may arise if you are operating two cooking zones at the same time and at the maximum power level. These whistling noises disappear or become quieter when you reduce the power level.</li> <li>▪ <b>Fan noises:</b> The cooktop is equipped with a fan that switches on automatically at high temperatures. The fan may also continue to run after you have switched the cooktop off if the temperature measured is still too high.</li> <li>▪ <b>Clicking:</b> Occasional clicking when activating or moving an item of cookware is completely normal. Now and again, other completely random noises that have nothing to do with the cookware may occur.</li> </ul>

### 13.3 Cookware

question	Answer
Which cookware is suitable for the induction cooktop?	<ul style="list-style-type: none"> <li>▪ You can find information on which cookware is suitable for induction cooking in the "Suitable cookware" section.</li> </ul>
Why is the cooktop not heating?	<ul style="list-style-type: none"> <li>▪ Ensure that the cookware is suitable for induction cooking. You can find more information on the type, size, and positioning of suitable cookware in the "Suitable cookware" section.</li> </ul>
Why is it taking so long for the cookware to heat up or why is it not heating up sufficiently despite being on a high power setting?	<ul style="list-style-type: none"> <li>▪ Ensure that the cookware is suitable for induction cooking. You can find more information on the type, size, and positioning of suitable cookware in the "Suitable cookware" section.</li> </ul>

question	Answer
The cookware display on the touch display does not correspond to the size or shape of the cookware.	<ul style="list-style-type: none"> <li>■ There are more than 8 items of cookware on the cooking surface. The cookware is too small: We recommend a diameter of 90 to 340 mm. Use a bigger item of cookware or cookware that is suitable for induction cooking. Alternatively, move the cookware to a different position on the cooking surface. You can find information on which cookware is suitable for induction cooking in the "Suitable cookware" section.</li> </ul>
An item of cookware that is not displayed on the touch display is located on the cooking surface.	<ul style="list-style-type: none"> <li>■ There are more than 8 items of cookware on the cooking surface. The cookware is too small: We recommend a diameter of 90 to 340 mm. Use a bigger item of cookware or cookware that is suitable for induction cooking. Alternatively, move the cookware to a different position on the cooking surface. You can find information on which cookware is suitable for induction cooking in the "Suitable cookware" section.</li> </ul>
Two items of cookware are on the cooking surface, but these are shown on the touch display as one item of cookware.	<ul style="list-style-type: none"> <li>■ If you place two items of cookware very close together on the cooking surface, this may appear on the touch display as one item of cookware. Move the items of cookware further away from each other until they are shown as two individual items of cookware on the touch display.</li> </ul>
One item of cookware is on the cooking surface, but two or more are shown on the touch display.	<ul style="list-style-type: none"> <li>■ The base of the cookware may be deformed or embossed, or the cookware is not suitable for induction cooking. Check the flatness of the cookware and place it back on the cooking surface. You can find information on which cookware is suitable for induction cooking in the "Suitable cookware" section.</li> </ul>
You cannot use any cookware that is on the cooking surface.	<ul style="list-style-type: none"> <li>■ You can place up to 8 items of cookware on the cooking surface but only up to 6 evenly distributed items can be used at the same time. You can find more information on the type, size, and positioning of suitable cookware in the "Suitable cookware" section.</li> <li>■ You can cook with up to 3 items of cookware on each side. If an item of cookware is located in the center of the cooking surface or the cookware is too big, this restricts the number of active items of cookware. You can find more information on the type, size, and positioning of suitable cookware in the "Suitable cookware" section.</li> <li>■ One of the items of cookware is not suitable for induction cooking. ⊖ appears beside the unsuitable cookware on the touch display. You can find more information on the type, size, and positioning of suitable cookware in the "Suitable cookware" section.</li> <li>■ The appliance has exceeded its maximum energy consumption or the Power limitation function has been switched off. Check the installation and set the Power limitation function correctly.</li> </ul>
The power level cannot be increased.	<ul style="list-style-type: none"> <li>■ The appliance has reached its maximum energy consumption or the Power limitation function has been switched off. Change the distribution of the cookware on the cooking surface. Check the installation and set the Power limitation function correctly. You can find out how to do this in the "Basic settings" section → <i>Page 32</i></li> </ul>
The cooking sensor is not available.	<ul style="list-style-type: none"> <li>■ The appliance has exceeded its maximum energy consumption or the Power limitation function has been switched on. Switch off or reduce the power levels for the other item of cookware. Change the distribution of the cookware on the cooking zone. Check the installation and set the Power limitation function correctly. Power limitation</li> </ul>
Cooking times are longer if you use the appliance intensively.	<ul style="list-style-type: none"> <li>■ This may be due to the fact that internal safety mechanisms are preventing the cooker from overheating. Try to change the position of the cookware.</li> </ul>

question	Answer
Bubbles are forming with an uneven distribution within the cookware.	<ul style="list-style-type: none"> <li>Depending on the selected power level, type of cookware, or the combination with other cookware, bubbles may form unevenly. However, this has no effect on the temperature or the cooking process.</li> </ul> <p>You can find information on which cookware is suitable for induction cooking in the "Suitable cookware" section.</p>

## 13.4 Cleaning

Question	Answer
How can I clean the cooktop?	<ul style="list-style-type: none"> <li>You can achieve the best results by using special glass-ceramic cleaning products. Do not use harsh or abrasive cleaning products, dishwasher detergent (concentrated) or scouring pads.</li> </ul> <p>You can find more information about this under → "Cleaning and maintenance", Page 36.</p>

## 13.5 Home network

question	Answer
Why can I not connect the cooktop to the Wi-Fi after the WPS button has been pressed on the router?	<ul style="list-style-type: none"> <li>Press the WPS button on the router within 2 minutes after selecting the "Automatic connection" option.</li> </ul> <p>Once this time has elapsed, start the connection set-up again. If the problems persist, restore the appliance to the factory settings.</p> <p>You can find out how to do this in the "Basic settings" section → Page 32.</p>
Why is my mobile device not logging into the Home Connect network?	<ul style="list-style-type: none"> <li>Connect to the Home Connect SSID and the Home Connect key.</li> </ul> <p>Make sure that you have entered all the characters correctly and that you have used upper and lower case in the relevant places.</p>

## 14 Customer Service

With any warranty repair, we will make sure your appliance is repaired by an authorized service provider using genuine replacement parts. We use only genuine replacement parts for all repairs.

Detailed information on the warranty period and terms of warranty can be found in the Statement of Limited Product Warranty, from your retailer, or on our website.

If you contact Customer Service, you will need the model number (E-Nr.) and the production number (FD) of your appliance.

USA:  
1-877-442-4436  
www.gaggenau.com  
www.gaggenau.com/us/appliances/eshop

CA:  
1-877-442-4436  
www.gaggenau.com  
www.gaggenau.ca

For assistance with connecting to Home Connect®, you can also view instructions here:  
www.home-connect.com/us/en/help-support/set-up

### 14.1 Model number (E-Nr.) and production number (FD)

You can find the model number (E-Nr.) and the production number (FD) on the appliance's rating plate.

The model number (E-Nr.) can also be found on the glass ceramic. You can also display the customer service index (KI) and the production number (FD) in the Basic settings → Page 32.

Making a note of your appliance's details and the Customer Service telephone number will enable you to find them again quickly.

### 14.2 Rating plate location

You can find the rating plate of your appliance:

- On the underside of the appliance.
- in the appliance pass
- You can also check the Customer Service Index (CSI) and the FD number in the basic settings.

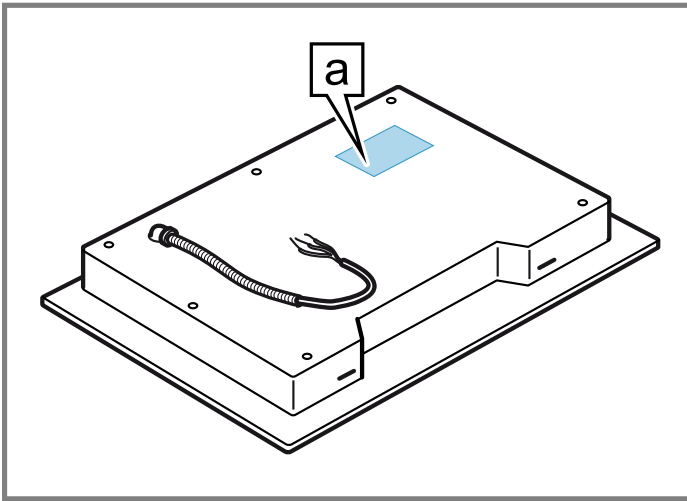

**a** Rating plate

## 15 STATEMENT OF LIMITED PRODUCT WARRANTY

### 15.1 What this warranty covers & Who it applies to

The limited warranty provided by BSH Home Appliances (“Gaggenau”) in this Statement of Limited Product Warranty applies only to the Gaggenau appliance sold to you (“Product”), provided that the Product was purchased:

- For your normal, household (non-commercial) use, and has in fact at all times only been used for normal household purposes.
- New at retail from a BSH authorized dealer or directly from BSH (not a display, “as is”, or previously returned model), and not for resale, or commercial use.
- Within the United States or Canada, and has at all times remained within the country of original purchase.

The warranties stated herein apply to the original purchaser of the product warranted herein and to each succeeding owner of the product purchased for ordinary home use during the term of the warranty.

Please make sure to register your Product; while not necessary to effectuate warranty coverage, it is the best way for Gaggenau to notify you in the unlikely event of a safety notice or product recall.

### 15.2 How long the warranty lasts

Gaggenau warrants that the Product is free from defects in materials and workmanship for a period of seven hundred and thirty (730) days from the date of the original delivery. The foregoing timeline begins to run upon the date of original delivery, and shall not be stalled, tolled, extended, or suspended, for any reason whatsoever. This Product is also warranted to be free from **cosmetic** defects in material and workmanship (such as scratches of stainless steel, paint/porcelain blemishes, chips, dents, or other damage to the finish) of the Product, for a period of sixty (60) days from the date of delivery or closing date for new

construction. This **cosmetic** warranty excludes slight color variations due to inherent differences in painted and porcelain parts, as well as differences caused by kitchen lighting, product location, or other similar factors. This **cosmetic** warranty specifically excludes any display, floor, “As Is”, or “B” stock appliances.

### 15.3 Repair/replace as your exclusive remedy

During this warranty period, Gaggenau or one of its authorized service providers will repair your Product without charge to you (subject to certain limitations stated herein) if your Product proves to have been manufactured with a defect in materials or workmanship. If reasonable attempts to repair the Product have been made without success, then Gaggenau will replace your Product (upgraded models may be available to you, in Gaggenau's sole discretion, for an additional charge). Nothing in this warranty requires damaged or defective parts to be replaced with parts of a different type or design than the original parts. All removed parts and components shall become the property of Gaggenau at its sole option. All replaced and/or repaired parts shall assume the identity of the original part for purposes of this warranty and this warranty shall not be extended with respect to such parts. Gaggenau's sole liability and responsibility hereunder is to repair manufacturer-defective Product only, using a Gaggenau authorized service provider during normal business hours. For safety and property damage concerns, Gaggenau highly recommends that you do not attempt to repair the Product yourself, or use a non-authorized service provider; Gaggenau will have no responsibility or liability for damage resulting from repairs or work performed by a non-authorized service provider. Authorized service providers are those persons or companies that have been specially trained on Gaggenau products, and who possess, in Gaggenau's opinion, a superior reputation for customer service and technical ability (note that they are independent entities and are not agents, partners, affiliates or representatives of Gaggenau). Nevertheless, taking your product to be serviced by a repair shop that is not affiliated with or an authorized dealer of Gaggenau will not void this warranty. Also, using third-party parts will not void this warranty. Notwithstanding the foregoing, Gaggenau will not incur any liability, or have responsibility, for the Product if it is located in a remote area (more than 100 miles from an authorized service provider) or is reasonably inaccessible, hazardous, threatening, or treacherous locale, surroundings, or environment; in any such event, if you request, Gaggenau would still pay for labor and parts and ship the parts to the nearest authorized service provider, but you would still be fully liable and responsible for any travel time or other special charges by the service company, assuming they agree to make the service call. Further, to the extent you have installed the Product in a difficult-to-access location or have otherwise installed temporary or permanent fixtures that create barriers to accessing or removing the Product, Gaggenau will not



incur any liability for, or have responsibility, for work or costs associated with moving the Product or otherwise creating access to the Product in order to repair or replace it. All such costs shall be your sole responsibility.

### 15.4 Out of warranty product

Gaggenau is under no obligation, at law or otherwise, to provide you with any concessions, including repairs, prorates, or Product replacement, once this warranty has expired.

### 15.5 Warranty exclusions

The warranty coverage described herein excludes all defects or damage that are not the direct fault of Gaggenau, including without limitation, one or more of the following:

- Use of the Product in anything other than its normal, customary and intended manner (including without limitation, any form of commercial use, use or storage of an indoor product outdoors, use of the Product in conjunction with air or water-going vessels).
- Any party's willful misconduct, negligence, misuse, abuse, accidents, neglect, improper operation, failure to maintain, improper or negligent installation, tampering, failure to follow operating instructions, mishandling, unauthorized service (including selfperformed "fixing" or exploration of the appliance's internal workings).
- Adjustment, alteration or modification of any kind.
- A failure to comply with any applicable state, local, city, or county electrical, plumbing and/or building codes, regulations, or laws, including failure to install the product in strict conformity with local fire and building codes and regulations.
- Ordinary wear and tear, spills of food, liquid, grease accumulations, or other substances that accumulate on, in, or around the Product.
- Any external, elemental and/or environmental forces and factors, including without limitation, rain, wind, sand, floods, fires, mud slides, freezing temperatures, excessive moisture or extended exposure to humidity, lightning, power surges, structural failures surrounding the appliance, and acts of God.
- Service calls to correct the installation of your Product, to instruct you how to use your Product, to replace house fuses or correct house wiring or plumbing.
- Removal and replacement of trim or decorative panels that interfere with servicing the Product.
- Damage or defects caused by labor or parts installed by any non-authorized service provider, unless approved by Gaggenau before service is performed.

In no event shall Gaggenau have any liability or responsibility whatsoever for damage to surrounding property, including cabinetry, floors, ceilings, and other structures or objects around the Product. Also excluded from this warranty are Products, on which the serial numbers have been altered, defaced, or removed; service visits to teach you how to use the Product, or visits where there is nothing wrong with the Product; correction of

installation problems (you are solely responsible for any structure and setting for the Product, including all electrical, plumbing or other connecting facilities, for proper foundation/flooring, and for any alterations including without limitation cabinetry, walls, floors, shelving, etc.); and resetting of breakers or fuses. TO THE EXTENT ALLOWED BY LAW, THIS WARRANTY SETS OUT YOUR EXCLUSIVE REMEDIES WITH RESPECT TO PRODUCT, WHETHER THE CLAIM ARISES IN CONTRACT OR TORT (INCLUDING STRICT LIABILITY, OR NEGLIGENCE) OR OTHERWISE. THIS WARRANTY IS IN LIEU OF ALL OTHER WARRANTIES, WHETHER EXPRESS OR IMPLIED. ANY WARRANTY IMPLIED BY LAW, WHETHER FOR MERCHANTABILITY OR FITNESS FOR A PARTICULAR PURPOSE, OR OTHERWISE, SHALL BE EFFECTIVE ONLY FOR THE PERIOD THAT THIS EXPRESS LIMITED WARRANTY IS EFFECTIVE. IN NO EVENT WILL THE MANUFACTURER BE LIABLE FOR CONSEQUENTIAL, SPECIAL, INCIDENTAL, INDIRECT, "BUSINESS LOSS", AND/OR PUNITIVE DAMAGES, LOSSES, OR EXPENSES, INCLUDING WITHOUT LIMITATION TIME AWAY FROM WORK, HOTELS AND/OR RESTAURANT MEALS, REMODELLING EXPENSES IN EXCESS OF DIRECT DAMAGES WHICH ARE DEFINITELY CAUSED EXCLUSIVELY BY GAGGENAU, OR OTHERWISE. SOME STATES DO NOT ALLOW THE EXCLUSION OR LIMITATION OF INCIDENTAL OR CONSEQUENTIAL DAMAGES, AND SOME STATES DO NOT ALLOW LIMITATIONS ON HOW LONG AN IMPLIED WARRANTY LASTS, SO THE ABOVE EXCLUSIONS OR LIMITATIONS MAY NOT APPLY TO YOU. THIS WARRANTY GIVES YOU SPECIFIC LEGAL RIGHTS, AND YOU MAY ALSO HAVE OTHER RIGHTS WHICH VARY FROM STATE TO STATE.

No attempt to alter, modify or amend this warranty shall be effective unless authorized in writing by an officer of BSH.

### 15.6 Obtaining warranty service

To obtain warranty service for your product, you should contact Gaggenau Customer Support at 1-877-442-4436 to schedule a repair.

### 15.7 Product information

For handy reference, copy the information below from the rating plate. Keep your invoice and/or delivery documents for warranty validation.

Model number (E-Nr.)
Production number (FD)
Date of delivery





**BSH Home Appliances Corporation**  
1901 Main Street, Suite 600  
Irvine, CA 92614  
USA  
[www.gaggenau.com](http://www.gaggenau.com)  
1-877-442-4436  
© 2024 BSH Home Appliances Corporation

**GAGGENAU**



9001444919 en-us (041115)