



**BOSCH**



Register your  
new device on  
MyBosch now and  
get free benefits:  
[bosch-home.com/  
welcome](https://bosch-home.com/welcome)

# Dishwasher

SC...

SK...

[en] User manual

## Table of contents

<b>Safety</b> .....	<b>4</b>	<b>Features</b> .....	<b>19</b>
General information .....	4	Basket .....	19
Intended use .....	4	Cutlery basket .....	20
Restriction on user group .....	4	Folding prongs .....	20
Safe installation .....	4	Height of tableware .....	20
Safe use .....	6	<b>Before using for the first time</b> .....	<b>20</b>
Damaged appliance .....	7	Performing the initial configuration .....	20
Risk to children .....	8	<b>Water softening system</b> .....	<b>21</b>
Safety systems .....	9	Overview of water hardness settings .....	21
<b>Preventing material damage</b> .....	<b>10</b>	Setting water softening system .....	21
Safe installation .....	10	Special salt .....	22
Safe use .....	10	Switching off water softening system .....	22
<b>Childproof lock<sup>1</sup></b> .....	<b>11</b>	Regeneration of the water softening system .....	23
Door lock .....	11	<b>Rinse aid system</b> .....	<b>24</b>
<b>Environmental protection and saving energy</b> .....	<b>11</b>	Rinse aid .....	24
Disposing of packaging .....	11	Setting the amount of rinse aid .....	24
Saving energy .....	11	Switching rinse aid system off .....	24
AquaSensor <sup>1</sup> .....	11	<b>Detergent</b> .....	<b>25</b>
<b>Installation and connection</b> .....	<b>11</b>	Suitable detergents .....	25
Scope of supply .....	11	Unsuitable detergents .....	26
Installing and connecting the appliance .....	12	Information on detergents .....	26
Drainage connection .....	12	Adding detergent .....	26
Drinking water connection .....	12	<b>Tableware</b> .....	<b>27</b>
Electrical connection .....	13	Damage to glass and tableware ....	27
<b>Familiarising yourself with your appliance</b> .....	<b>14</b>	Arrange tableware .....	28
Appliance .....	14	Removing tableware .....	28
Controls .....	15	<b>Basic operation</b> .....	<b>29</b>
<b>Programmes</b> .....	<b>17</b>	Opening appliance door .....	29
Information for test institutes .....	18	Switching on the appliance .....	29
<b>Additional functions<sup>1</sup></b> .....	<b>19</b>	Setting a programme .....	29
		Setting additional functions .....	29
		Setting timer programming <sup>1</sup> .....	29

<sup>1</sup> Depending on the appliance specifications

Starting the programme .....	30
Interrupting programme .....	30
Terminate programme.....	30
Switching off appliance .....	30
<b>Basic settings.....</b>	<b>31</b>
Overview of basic settings .....	31
<b>Cleaning and servicing.....</b>	<b>31</b>
Cleaning the tub .....	31
Self-cleaning interior <sup>1</sup> .....	32
Cleaning products .....	32
Tips on appliance care.....	32
Filter system .....	32
Cleaning the spray arm.....	33
<b>Troubleshooting.....</b>	<b>34</b>
Appliance safety.....	34
Error code / Fault display / Sig- nal.....	34
Washing results.....	36
Information on display panel.....	43
Malfunctions .....	43
Mechanical damage.....	44
Noise .....	44
Clean wastewater pump.....	46
<b>Transportation, storage and disposal .....</b>	<b>46</b>
Removing the appliance .....	46
Protect appliance from frost.....	47
Transporting the appliance .....	47
Disposing of old appliance .....	47
<b>Customer Service.....</b>	<b>47</b>
Product number (E-Nr.) and pro- duction number (FD).....	48
<b>Technical specifications.....</b>	<b>48</b>

---

<sup>1</sup> Depending on the appliance specifications



## Safety

---

Observe the following safety instructions.

### General information

- Read this instruction manual carefully.
- Keep the instruction manual and the product information safe for future reference or for the next owner.
- Do not connect the appliance if it has been damaged in transit.

### Intended use

Only use this appliance:

- For cleaning household tableware.
- In private households and in enclosed spaces in a domestic environment.
- Up to an altitude of 4000 m above sea level.

### Restriction on user group

This appliance may be used by children aged 8 or over and by people who have reduced physical, sensory or mental abilities or inadequate experience and/or knowledge, provided that they are supervised or have been instructed on how to use the appliance safely and have understood the resulting dangers.

Children must not play with the appliance.

Cleaning and user maintenance must not be performed by children unless they are being supervised.

Keep children under the age of 8 years away from the appliance and power cable.

### Safe installation

#### **WARNING – Risk of injury!**

Improper installation may cause injury.

- ▶ When installing and connecting the appliance, follow the instructions in the manual and installation instructions.

** WARNING – Risk of electric shock!**

Incorrect installation is dangerous.

- ▶ Connect and operate the appliance only in accordance with the specifications on the rating plate.
- ▶ Always use the supplied power cable for the new appliance.
- ▶ Connect the appliance to a power supply with alternating current only via a properly installed socket with earthing.
- ▶ The protective conductor system of the domestic electrical installation must be properly installed.
- ▶ Never equip the appliance with an external switching device, e.g. a timer or remote control.
- ▶ When the appliance is installed, the mains plug of the power cord must be freely accessible. If free access is not possible, an all-pole isolating switch must be installed in the permanent electrical installation according to the installation regulations.
- ▶ When installing the appliance, check that the power cable is not trapped or damaged.

** WARNING – Risk of fire!**

It is dangerous to use an extended power cord and non-approved adapters.

- ▶ Do not use extension cables or multiple socket strips.
- ▶ If the power cord is too short, contact Customer Service.
- ▶ Only use adapters approved by the manufacturer.

** WARNING – Risk of burns!**

If the appliance is not installed properly, this may result in burns.

- ▶ With free-standing appliances, ensure that they are installed with the back panel against a wall.

## Safe use

### **WARNING – Risk of serious harm to health!**

Failure to comply with safety instructions and directions for use on packagings of detergent and rinse aid products may cause serious harm to health.

- ▶ Follow the safety instructions and directions for use on the packagings of detergent and rinse aid products.

### **WARNING – Risk of explosion!**

- Adding solvents to the interior of the appliance may cause explosions.
  - ▶ Never add solvents to the interior of the appliance.
- Highly caustic alkaline or highly acidic cleaning agents in conjunction with aluminium parts in the interior of the appliance may cause explosions.
  - ▶ Never use highly caustic alkaline or highly acidic cleaning agents, in particular commercial or industrial products, in conjunction with aluminium parts (e.g. grease filters of extractor hoods or aluminium pans), e.g. for the Machine Care programme.

### **WARNING – Risk of injury!**

- Leaving the appliance door open may result in injury.
  - ▶ Only open the appliance door to load or unload tableware in order to prevent accidents, e.g. through tripping.
  - ▶ Do not sit or stand on the appliance door when open.
- Knives and utensils with sharp points can cause injuries.
  - ▶ Arrange knives and utensils with sharp points in the cutlery basket with the points downwards, on the knife shelf or in the cutlery drawer.

### **WARNING – Risk of scalding!**

If you open the appliance door while the programme is running, hot water may splash out of the appliance.

- ▶ Open the appliance door carefully if the programme is still running.

**⚠ WARNING – Risk of tipping!**

- Overfilling the Baskets may cause the appliance to tip up.
- ▶ Never overfill the Baskets with free-standing appliances.

**⚠ WARNING – Risk of electric shock!**

- An ingress of moisture can cause an electric shock.
  - ▶ Only use the appliance in enclosed spaces.
  - ▶ Never expose the appliance to intense heat or humidity.
  - ▶ Do not use steam- or high-pressure cleaners to clean the appliance.
- If the insulation of the power cord is damaged, this is dangerous.
  - ▶ Never let the power cord come into contact with hot appliance parts or heat sources.
  - ▶ Never let the power cord come into contact with sharp points or edges.
  - ▶ Never kink, crush or modify the power cord.

**Damaged appliance****⚠ WARNING – Risk of electric shock!**

- If the appliance or the power cord is damaged, this is dangerous.
  - ▶ Never operate a damaged appliance.
  - ▶ Never operate an appliance with a cracked or fractured surface.
  - ▶ Never pull on the power cord to unplug the appliance. Always unplug the appliance at the mains.
  - ▶ If the appliance or the power cord is damaged, immediately unplug the power cord or switch off the fuse in the fuse box and turn off the water tap.
  - ▶ "Call customer services." → *Page 47*
- Incorrect repairs are dangerous.
  - ▶ Repairs to the appliance should only be carried out by trained specialist staff.
  - ▶ Only use genuine spare parts when repairing the appliance.

- ▶ If the power cord of this appliance is damaged, it must be replaced with a special connection cable, which is available from the manufacturer or his Customer Service.

## **Risk to children**

### **⚠ WARNING – Risk of suffocation!**

- Children may put packaging material over their heads or wrap themselves up in it and suffocate.
  - ▶ Keep packaging material away from children.
  - ▶ Do not let children play with packaging material.
- Children may breathe in or swallow small parts, causing them to suffocate.
  - ▶ Keep small parts away from children.
  - ▶ Do not let children play with small parts.
- Children may become trapped in the appliance and suffocate.
  - ▶ Use the childproof lock if fitted.
  - ▶ Never let children play with or operate the appliance.

### **⚠ WARNING – Risk of harm to health!**

Children can lock themselves in the appliance, thereby putting their lives at risk.

- ▶ With redundant appliances, unplug the power cord. Then cut through the cord and damage the lock on the appliance door beyond repair so that the appliance door will no longer close.

### **⚠ WARNING – Risk of crushing!**

With higher-level appliances, children can become crushed between the appliance door and cabinet doors underneath.

- ▶ Keep an eye on children when opening and closing the appliance door.

### **⚠ WARNING – Risk of chemical burns!**

Rinse aid and detergent may cause chemical burns to the mouth, throat and eyes.

- ▶ Keep children away from detergent and rinse aid products.



- ▶ Keep children away from the appliance when open. The water in the interior of the dishwasher is not drinking water. It may contain residues of detergents and rinse aid.

## **Safety systems**

Protect children from possible hazards resulting from the appliance.

Depending on the features of the model, the appliance comes with a

→ *"Childproof lock", Page 11.*

---

## Preventing material damage

### Safe installation

#### ATTENTION!

- Improper installation of the appliance may cause damage.
  - ▶ If the dishwasher is installed above or below other domestic appliances, follow the information on installation in combination with a dishwasher in the installation instructions for the individual appliances.
  - ▶ If there is no information or if the installation instructions do not include the relevant information, contact the manufacturer of these appliances to check that the dishwasher can be installed above or below these appliances.
  - ▶ If no information is available from the manufacturer, the dishwasher should not be installed above or below such appliances.
  - ▶ To ensure the safe operation of all domestic appliances, continue following the installation instructions for the dishwasher.
  - ▶ Only install the dishwasher below a hob after taking into consideration the specified safety clearances.
  - ▶ Do not install the dishwasher near heat sources, e.g. radiators, heat storage tanks, ovens or other appliances that generate heat.
- Modified or damaged water hoses may result in material damage and damage to the appliance.
  - ▶ Never kink, crush, modify or cut through water hoses.

- ▶ Only use the water hoses supplied with the appliance or genuine spare hoses.
- ▶ Never re-use water hoses that have been used before.
- If the water pressure is too high or too low, the appliance may not be able to operate properly.
  - ▶ Make sure that the water pressure in the water supply system is min. 50 kPa (0.5 bar) and max. 1000 kPa (10 bar).
  - ▶ If the water pressure exceeds the maximum value specified, a pressure-reducing valve must be installed between the drinking water connection and the hose set of the appliance.

### Safe use

#### ATTENTION!

- Escaping water vapour can damage fitted units.
  - ▶ When the programme ends, leave the appliance to cool down for a while before opening the door.
- Special salt for dishwashers can damage the tub due to corrosion.
  - ▶ To make sure that any special salt that escapes is washed out of the tub, add the special salt to the dispenser for special salt immediately before the programme starts.
- Detergent may damage the water softening system.
  - ▶ Only fill the dispenser of the water softening system with special dishwasher salt.
- Unsuitable cleaning agents may damage the appliance.
  - ▶ Do not use a steam cleaner.
  - ▶ So as not to scratch the finish on the appliance, do not use sponges with a rough surface or abrasive cleaning agents.

- ▶ To prevent corrosion, do not use sponge cloths on dishwashers with a stainless steel front or rinse such cloths thoroughly several times before using them for the first time.

---

## Childproof lock<sup>1</sup>

The childproof lock lets you protect children from possible hazards resulting from the appliance.

Depending on the features of the model, the appliance comes with a door lock.

### Door lock

The door lock is a mechanical safety system and makes it more difficult to open the appliance door.

→ *"Opening appliance door", Page 29*

---

## Environmental protection and saving energy

### Disposing of packaging

The packaging materials are environmentally compatible and can be recycled.

- ▶ Sort the individual components by type and dispose of them separately.

## Saving energy

If you follow these instructions, your appliance will use less electricity and less water.

Use the Eco 50 ° programme.

- + The Eco 50 ° programme is energy-efficient and environmentally friendly.

## AquaSensor<sup>1</sup>

The AquaSensor is an optical measuring device (light barrier) which measures the turbidity of the washing water. You can save water with the AquaSensor.

Use of the AquaSensor depends on the programme. If the soiling level is low, the washing water is used in the next wash cycle, allowing water consumption to be reduced by 2-4 litres. If the soiling level is higher, the washing water is drained off and replaced with fresh water. In the automatic programmes the temperature and running time are additionally adjusted to the level of soiling.

---

## Installation and connection

### Scope of supply

After unpacking all parts, check for any damage in transit and completeness of the delivery.

If you have any complaints, contact the dealer who sold you the appliance or our Customer Service.

---

<sup>1</sup> Depending on the appliance specifications

**Note:** The appliance has been tested at the factory to check it is in working order. It is possible that water has left marks on the appliance. These marks will disappear after the first wash cycle.

The delivery consists of the following:

- Dishwasher
- User manual
- Installation Instructions
- Warranty<sup>1</sup>
- Installation material
- Steam guard plate<sup>1</sup>
- Rubber apron<sup>1</sup>
- Mains cable
- Quick reference guide<sup>1</sup>

## Installing and connecting the appliance

You can position your appliance in a fitted kitchen between wooden and plastic walls.

1. "Follow the safety instructions."  
→ *Page 4*
2. "Follow the instructions for electrical connection." → *Page 13*
3. Check the "Scope of supply" → *Page 11* and the condition of the appliance.
4. Consult the installation instructions for the installation dimensions required.
5. Set the appliance up so it is level.  
Make sure that the appliance is standing on the floor securely.
6. "Install the drainage connection."  
→ *Page 12*
7. "Install the drinking water connection." → *Page 12*
8. Connect the appliance to the power supply.

## Drainage connection

Connect your appliance to drainage connection so dirty water is discharged via the wash cycle.

### Installing the drainage connection

1. Consult the installation instructions supplied for the steps required here.
2. Connect the wastewater hose to the outlet connection of the siphon using the enclosed parts.
3. When doing so, check that the wastewater hose is not kinked, crushed or twisted.
4. Also check that there is no cover in the drainage system preventing the wastewater from being discharged.

## Drinking water connection

Connect your appliance to a drinking water connection.

### Installing the drinking water connection

#### Note

- If you are replacing the appliance, you must use a new water supply hose.
1. Consult the installation instructions supplied for the steps required here.
  2. Connect the appliance to the drinking water connection using the enclosed parts.  
Observe the "Technical data" → *Page 48*.
  3. When doing so, check that the drinking water connection is not kinked, crushed or twisted.

---

<sup>1</sup> Depending on the appliance specifications

## Electrical connection

Connect your appliance to the power supply.

### Connecting the appliance to the electricity supply

#### Notes

- Please follow the "Safety instructions" → *Page 4*.
  - Connect the appliance to alternating current only, in the range of 220 - 240 V and 50 Hz or 60 Hz.
  - Please note that the water safety system is only functional if there is a power supply.
1. Insert the non-heating appliance plug of the power cable into the appliance.
  2. Insert the mains plug of the appliance into a nearby socket.  
The connection data for the appliance can be found on the rating plate.
  3. Check that the mains plug is inserted properly.

## Familiarising yourself with your appliance

### Appliance

You can find an overview of the parts of your appliance here.

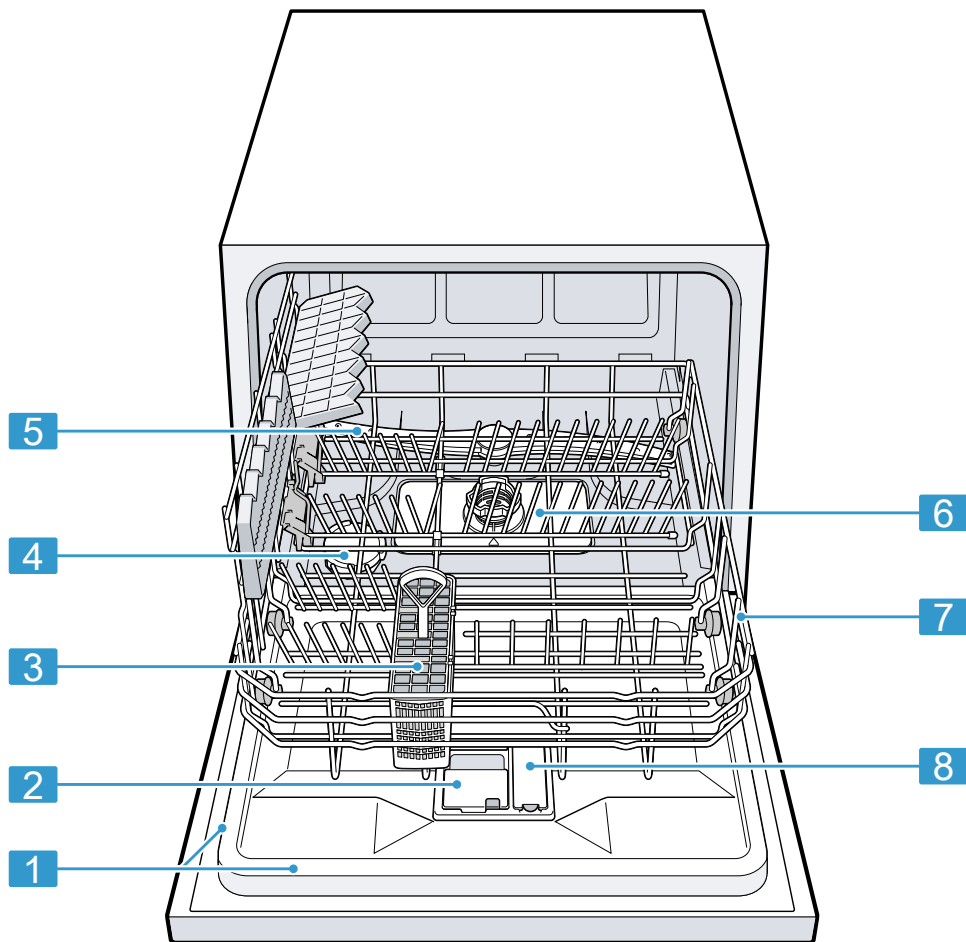

1

Rating plate

Rating plate with "E number and FD number"  
→ Page 48.  
The data you need for "Customer Service"  
→ Page 47.

<sup>1</sup> Depending on the appliance specifications

<b>2</b>	Detergent dispenser	"Detergent" → <i>Page 25</i> is added to the detergent dispenser.
<b>3</b>	Cutlery basket <sup>1</sup>	"Cutlery basket" → <i>Page 20</i>
<b>4</b>	Dispenser for special salt	Add special salt to the dispenser for special salt. → " <i>Water softening system</i> ", <i>Page 21</i>
<b>5</b>	Spray arm	The spray arm washes the tableware in the basket. If the tableware has not been washed properly, clean the spray arm. → " <i>Cleaning the spray arm</i> ", <i>Page 33</i>
<b>6</b>	Filter system	"Filter system" → <i>Page 32</i>
<b>7</b>	Basket	"Basket" → <i>Page 19</i>
<b>8</b>	Dispenser for rinse aid	Add rinse aid to the dispenser for rinse aid. → " <i>Rinse aid system</i> ", <i>Page 24</i>

<sup>1</sup> Depending on the appliance specifications

## Controls

You can use the control panel to configure all functions of your appliance and to obtain information about the operating status.  
With some buttons you can perform different functions.

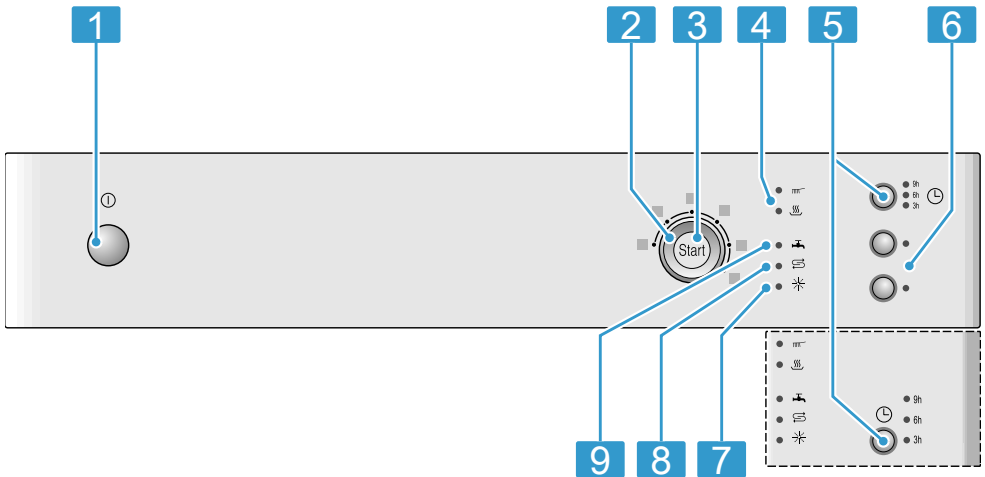

<b>1</b>	ON/OFF button ⓘ	"Switching on the appliance" → <i>Page 29</i> "Switching off the appliance" → <i>Page 30</i>
<b>2</b>	Programme selector	"Programmes" → <i>Page 17</i>

<sup>1</sup> Depending on the appliance specifications

**en** Familiarising yourself with your appliance

<b>3</b>	Start button <b>Start</b> and reset button <b>Reset 3 sec.</b>	"Starting the programme" → <i>Page 30</i> "Terminating the programme" → <i>Page 30</i>
<b>4</b>	Programme sequence display	The programme sequence display shows the current cycle of the appliance, e.g. washing or drying.
<b>5</b>	Timer programming <sup>1</sup>	"Setting timer programming" → <i>Page 29</i>
<b>6</b>	Additional functions <sup>1</sup>	"Additional functions" → <i>Page 19</i>
<b>7</b>	Rinse aid refill indicator	"Rinse aid system" → <i>Page 24</i>
<b>8</b>	Special salt refill indicator	"Water softening system" → <i>Page 21</i>
<b>9</b>	Water supply display	Display for water supply



<sup>1</sup> Depending on the appliance specifications







## Programmes

You can find an overview of the programmes that can be selected here. Different programmes, which can be found on the control panel of your appliance, are available depending on the appliance configuration. The running time may vary depending on the programme selected. The running time depends on the water temperature, the quantity of tableware, the level of soiling and the additional function selected. The run-

ning time will change if the rinse aid system is switched off or rinse aid needs to be added. The consumption values can be found in the quick reference guide. The consumption values relate to normal conditions and a water hardness of 9 - 20 °E. Different influencing factors such as water temperature or pipe pressure may result in deviations.

Programme	Use	Programme sequence	Additional functions
 Intensive 70°	Dishes: <ul style="list-style-type: none"> <li>■ Washing pots and pans, non-fragile tableware and cutlery.</li> </ul> Level of soiling: <ul style="list-style-type: none"> <li>■ Removing stubborn burned or dried-on food remnants containing starch and protein.</li> </ul> When using powder detergent, you can also apply a little to the inside of the appliance door.	Intensive: <ul style="list-style-type: none"> <li>■ Pre-rinse</li> <li>■ Cleaning 70 °C</li> <li>■ Intermediate rinse</li> <li>■ Final rinse 69 °C</li> <li>■ Drying</li> </ul>	All → "Additional functions", Page 19
 Normal 65°	Dishes: <ul style="list-style-type: none"> <li>■ Cleaning mixed dishes and cutlery.</li> </ul> Level of soiling: <ul style="list-style-type: none"> <li>■ Removing common household food remnants normally to firmly dried-on.</li> </ul>	Intensive: <ul style="list-style-type: none"> <li>■ Pre-rinse</li> <li>■ Cleaning 65 °C</li> <li>■ Intermediate rinse</li> <li>■ Final rinse 69 °C</li> <li>■ Drying</li> </ul>	All → "Additional functions", Page 19

Programme	Use	Programme sequence	Additional functions
 Eco 50°	Dishes: <ul style="list-style-type: none"> <li>■ Cleaning mixed dishes and cutlery.</li> </ul> Level of soiling: <ul style="list-style-type: none"> <li>■ Removing common household food remnants lightly dried-on.</li> </ul>	Most economical: <ul style="list-style-type: none"> <li>■ Pre-rinse</li> <li>■ Cleaning 50 °C</li> <li>■ Intermediate rinse</li> <li>■ Final rinse 66 °C</li> <li>■ Drying</li> </ul>	All → "Additional functions", Page 19
 Glass 40°	Dishes: <ul style="list-style-type: none"> <li>■ Cleaning delicate tableware, cutlery, temperature-sensitive plastics, glasses and stemware in the stemware basket.</li> </ul> Level of soiling: <ul style="list-style-type: none"> <li>■ Removing lightly adhering fresh food remnants.</li> </ul>	Particularly gentle: <ul style="list-style-type: none"> <li>■ Pre-rinse</li> <li>■ Cleaning 40 °C</li> <li>■ Intermediate rinse</li> <li>■ Final rinse 60 °C</li> <li>■ Drying</li> </ul>	VarioSpeed ExtraDry → "Additional functions", Page 19
 Quick 45°	Dishes: <ul style="list-style-type: none"> <li>■ Cleaning delicate tableware, cutlery, temperature-sensitive plastics and glasses.</li> </ul> Level of soiling: <ul style="list-style-type: none"> <li>■ Removing lightly adhering fresh food remnants.</li> </ul>	Time-optimised: <ul style="list-style-type: none"> <li>■ Cleaning 45 °C</li> <li>■ Intermediate rinse</li> <li>■ Final rinse 55 °C</li> </ul>	ExtraDry → "Additional functions", Page 19
 PreRinse	Dishes: <ul style="list-style-type: none"> <li>■ Cleaning all types of dishes.</li> </ul> Level of soiling: <ul style="list-style-type: none"> <li>■ Cold rinsing, intermediate cleaning.</li> </ul>	Cold rinse suitable: <ul style="list-style-type: none"> <li>■ Pre-rinse</li> </ul>	None

## Information for test institutes



Test institutes are provided with information for comparability tests, e.g. according to EN60436. These are the conditions for conducting the tests, however they are not the results or consumption values.

E-mail enquiries to: [dishwasher@test-appliances.com](mailto:dishwasher@test-appliances.com)

The product number (E-Nr.) and the production number (FD) are required here. They can be found on the rating plate on the appliance door.

## Additional functions<sup>1</sup>

You can find an overview of the additional functions that can be selected here. Different additional functions, which can be found on the control panel of your appliance, are available depending on the appliance configuration.

Additional function	Use
 VarioSpeed	<ul style="list-style-type: none"> <li>■ The running time is shortened by 20% to 50% depending on the washing programme.</li> <li>■ Energy and water consumption are increased.</li> </ul>
 Hygiene	<ul style="list-style-type: none"> <li>■ To ensure a higher hygiene status for the appliance and dishes, the temperature is raised and maintained for an extra-long period.</li> <li>■ Especially suitable for cleaning chopping boards or baby bottles.</li> <li>■ Continuous use of this function increases the hygiene status.</li> <li>■ This will increase the running time and energy consumption.</li> </ul>
 ExtraDry	<ul style="list-style-type: none"> <li>■ For a better drying result the final rinse temperature is increased and the drying phase extended.</li> </ul>

Additional function	Use
	<ul style="list-style-type: none"> <li>■ Especially suitable for drying plastic parts.</li> <li>■ There is a slight increase in energy consumption and the running time is extended.</li> </ul>

## Features

You can find an overview of the possible features of your appliance and how to use them here. These features depend on the model of your appliance.

### Basket

Arrange the tableware in the basket.

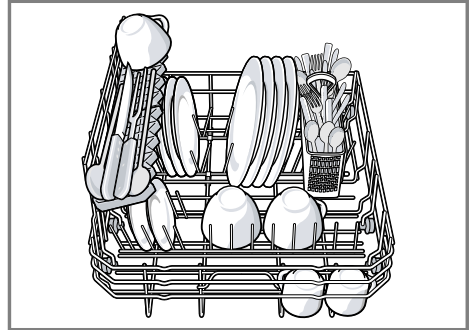

<sup>1</sup> Depending on the appliance specifications

en Before using for the first time

## Cutlery basket

Arrange cutlery in the cutlery basket, always without sorting it and with the sharp points downwards.

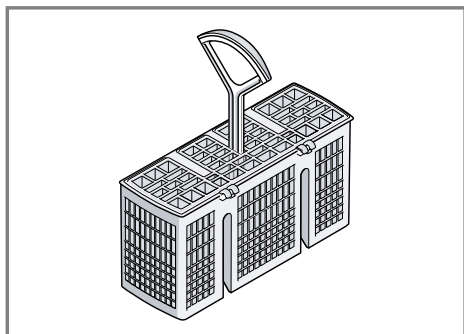

1. Push the lever forwards ① and fold down the prongs ②.

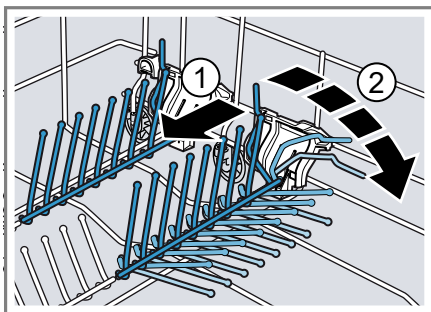

2. To use the prongs again, fold them back up.  
✓ The prongs audibly click into position.

## Folding prongs

Use the folding prongs to position tableware securely, e.g. plates.

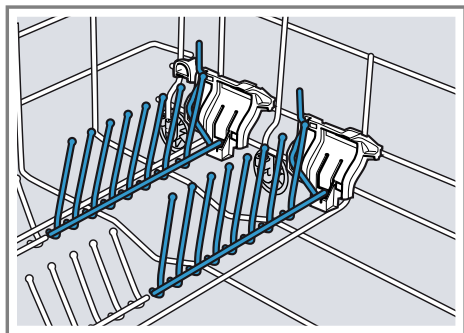

You can fold the prongs down to position pans, bowls and glasses better.<sup>1</sup>

## Folding down prongs<sup>1</sup>

If you do not need the prongs, fold them down.

## Height of tableware

You can place tableware with a maximum height of 28 cm in the basket.

---

## Before using for the first time

### Performing the initial configuration

On initial start-up or after a reset to the factory settings, you will need to make settings.

**Requirement:** "The appliance has been installed and connected."

→ Page 11

1. "Add special salt." → Page 22
2. "Add rinse aid." → Page 24
3. "Switch on the appliance."  
→ Page 29
4. "Setting the water softening system." → Page 21

---

<sup>1</sup> Depending on the appliance specifications

5. "Set the amount of rinse aid to be dispensed." → *Page 24*
6. "Add detergent" → *Page 25*.
7. Start the Programme with the highest cleaning temperature without tableware.















To remove any marks from water or other residues, we recommend you operate the appliance without tableware before using it for the first time.

**Tip:** You can change these settings and other "Basic settings" → *Page 31* at any time.

## Overview of water hardness settings

You can find an overview of the water hardness values that can be selected here.

You can find out how hard your water is from your local water company or by using a water hardness tester.

Water hardness value °E	Hardness range	mmol/l	Level	LED 	LED 	LED 
0-8	Soft	0-1.1	0			
9-20	Medium	1.2-2.9	1			
21-26	Hard	3.0-3.7	2			
27-44	Hard	3.8-6.2	3			

**Note:** Set the water hardness determined on your appliance.

With a water hardness of 0 - 8 °E you can dispense with special salt and switch off the water softening system.



## Setting water softening system

Set the water hardness on your appliance.

1. Determine the water hardness and the appropriate setting value.
2. Press .

## Water softening system

Hard water leaves limescale on the tub and tableware and parts of the appliance may become blocked. To ensure good dishwashing results, you can treat the water with special salt and the water softening system. To avoid damage to the appliance, water with a hardness above 9 °E must be softened.

3. Press and hold Start.
4. Turn the programme selector until  flashes.
5. Release the button.
6. Turn the programme selector until the required level has been set. 0, 1, 2 or 3 LEDs will light up accordingly.  
→ "Overview of water hardness settings", *Page 21*  
The factory setting is level 1 (LED .
7. Press Start to save the setting.  
✓ The LEDs go out.

## Special salt

You can use special salt to soften water.

### Adding special salt

If the special salt refill indicator lights up, add special salt to the dispenser for special salt just before the programme starts. The amount of special salt required depends on the water hardness: the higher the water hardness, the greater the amount of special salt required.

### ATTENTION!

- Detergent may damage the water softening system.
    - ▶ Only fill the dispenser of the water softening system with special dishwasher salt.
  - Special salt can damage the tub due to corrosion.
    - ▶ To make sure that any special salt that escapes is washed out of the tub, add the special salt to the dispenser for special salt immediately before the programme starts.
1. Unscrew the lid of the dispenser for special salt and remove.
  2. On initial start-up: Fill the dispenser right up with water.

3. **Note:** Only use special salt for dishwashers.

Do not use salt tablets.

Do not use table salt.

Add the special salt to the dispenser.

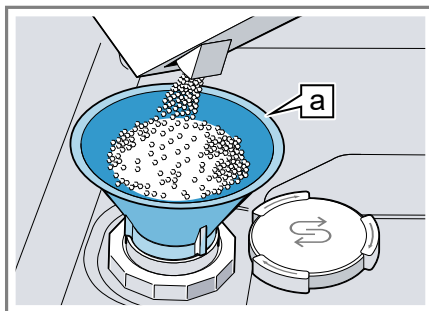

Funnel [a]<sup>1</sup>

Fill the dispenser right up with special salt. The water in the dispenser is displaced and forced out.

4. Place the lid back on the dispenser and turn to close.

## Switching off water softening system

If you find the special salt refill indicator irritating, e.g. when using combined detergents with salt replacement substances, you can switch the salt refill indicator off.



### Note

To avoid damage to the appliance, only switch off the water softening system in the following cases:

- The water hardness is max. 26 °E and you are using combined detergents with salt replacement substances. According to manufacturers, combined detergents with salt replacement substances can gen-

<sup>1</sup> Depending on the appliance specifications

erally only be used up to a water hardness of 26 °E without adding special salt.

- The water hardness is 0 - 8 °E. You do not need to use special salt.
1. Press .
  2. Press and hold Start.
  3. Turn the programme selector until  flashes.
  4. Release the button.
  5. Turn the programme selector until no LED lights up (level 0).  
→ "Overview of water hardness settings", Page 21

6. Press Start to save the setting.
  - ✓ The LEDs go out.
  - ✓ The water softening system is switched off and the salt refill indicator is deactivated.

## Regeneration of the water softening system

In order to obtain fault-free function of the water softening system, the appliance performs reheating of the water softening system at regular intervals. Regeneration of the water softening system takes place before the end of the main rinse cycle in all programmes. It will increase the run time and consumption values, e.g. water and electricity.

## Overview of consumption values with regeneration the water softening system

Here you can find an overview of the maximum additional running time and consumption values during regeneration of the water softening system. You can find the column applicable to your model in the quick reference guide according to its water consumption in the Eco 50° programme.

Water consumption in litres (depending on model)	Regeneration of the water softening system after x rinse cycles	Additional running time in minutes	Additional water consumption in litres	Additional power consumption in kWh
8	5	4	2.5	0.03
9	4	4	2.5	0.03

The consumption values specified are laboratory measurements determined in accordance with the currently applicable standard and using the Eco 50° programme and the factory value of the water hardness is set to 9 - 20°E.

## Rinse aid system

You can use the rinse aid system and rinse aid to get tableware and glasses rinsed perfectly without marks.

### Rinse aid

For optimum drying results, use rinse aid.

Only use rinse aid for domestic dishwashers.

### Adding rinse aid

If the rinse aid refill indicator lights up, top up with rinse aid. Only use rinse aid for domestic dishwashers.

1. Press the catch on the lid of the dispenser for rinse aid ① and lift ②.

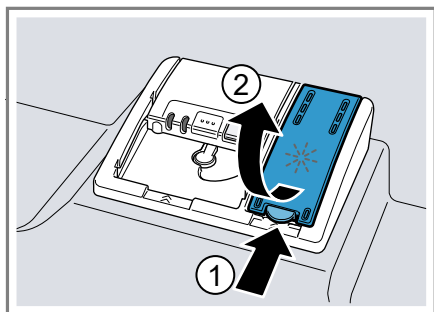

2. Add rinse aid up to the max mark.

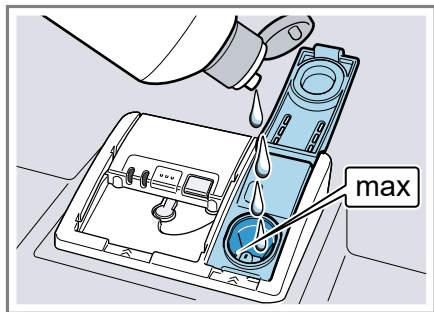

3. If rinse aid spills out, remove it from the tub.

Spilled rinse aid can cause excessive frothing during the wash cycle.



4. Close the lid of the dispenser for rinse aid.
  - ✓ The lid clicks into position.

### Setting the amount of rinse aid

If there are streaks or water marks on tableware, change the amount of rinse aid.

1. Press ①.
2. Press and hold Start.
3. Turn the programme selector until \* flashes.
4. Release the button.
5. Turn the programme selector until the right amount of rinse aid has been set.

0, 1, 2 or 3 LEDs will light up accordingly.

The factory setting is level 2 (LED , and LED .

- A low setting adds less rinse aid during the wash cycle and reduces streaking on tableware.
- A higher setting adds more rinse aid during the wash cycle, reduces water marks and improves the drying result.

6. Press Start to save the setting.
  - ✓ The LEDs go out.

### Switching rinse aid system off

If you find the rinse aid refill indicator irritating, e.g. when using combined detergents with a rinse aid component, you can switch the rinse aid system off.

**Tip:** The function of rinse aid is limited with combined detergents. You will generally get better results using rinse aid.



1. Press ①.
2. Press and hold Start.
3. Turn the programme selector until \* flashes.
4. Release the button.
5. Turn the programme selector until no LED lights up (level 0).
6. Press Start to save the setting.
  - ✓ The LEDs go out.
  - ✓ The rinse aid system is switched off and the rinse aid refill indicator is deactivated.

## Detergent

### Suitable detergents

Only use detergents that are suitable for dishwashers. Both separate and combined detergents are suitable. For optimum washing and drying results, use separate detergent, adding "Special salt" → *Page 22* and "Rinse aid" → *Page 24* separately. Modern, powerful detergents mainly use a low-alkaline formulation with enzymes. Enzymes break down starch and remove protein. Oxygen-based bleaching agents are generally used to remove coloured marks, e.g. tea or ketchup.

**Note:** Follow the manufacturer's instructions for each detergent.

Detergent	Description
Tabs	<p>Tabs are suitable for all cleaning functions and do not need to be measured out.</p> <p>With shorter Programmes tabs sometimes do not dissolve entirely and leave residues of detergent. This may impair the cleaning effect.</p>

Detergent	Description
Powder detergent	<p>Powder detergent is recommended for shorter Programmes.</p> <p>The dosage can be adjusted to the level of soiling.</p>
Liquid detergent	<p>Liquid detergent works faster and is recommended for shorter Programmes without PreRinse.</p> <p>Sometimes liquid detergent may leak out despite the detergent dispenser being closed. This is not a fault and is non-critical if you remember the following:</p> <ul style="list-style-type: none"> <li>■ Only choose a programme without PreRinse.</li> <li>■ Do not select timer programming for starting the programme.</li> </ul> <p>The dosage can be adjusted to the level of soiling.</p>

**Tip:** Suitable detergents are available online via our website or from "Customer Service" → *Page 47*.

### Separate detergents

Separate detergents are products that do not contain components other than detergent, e.g. powder detergent or liquid detergent.

With powder and liquid detergent the dosage can be individually adjusted to the level of soiling of the tableware.

For better washing and drying results and to avoid damage to the appliance, please additionally use "Special salt" → *Page 22* and "Rinse aid" → *Page 24*.

## Combined detergent

Besides conventional separate detergents, a number of products are available with additional functions. These products contain not only detergent but also rinse aid and salt replacement substances (3in1) and, depending on the combination (4in1, 5in1, ...), additional components such as glass protection or stainless steel cleaner.

According to manufacturers, combined detergents generally only function up to a water hardness of 26 °E. With a water hardness above 26 °E you will need to add special salt and rinse aid. For the best washing and drying results we recommend using special salt and rinse aid from a water hardness of 17 °E. If you are using combined detergent, the washing programme is adjusted automatically to ensure the best possible washing and drying result.

## Unsuitable detergents

Do not use detergent which could cause damage to the appliance or present a risk to health.

Detergent	Description
Hand washing-up liquid	Hand washing-up liquid can cause increased frothing and damage the appliance.
Detergent containing chlorine	Chlorine residue on tableware may present a risk to health.

## Information on detergents

Follow the instructions on detergents in everyday use.

- Detergents marked as "organic" or "ecological" (environmentally friendly) generally contain lower levels of active agents or com-

pletely dispense with certain substances. The cleaning effect may be restricted here.

- Set the rinse aid and the water softening system to the separate detergent or combined detergent in use.
- According to manufacturers, combined detergents with salt replacement substances can only be used up to a certain water hardness, usually 26 °E, without adding special salt. For the best washing and drying results we recommend using special salt from a water hardness of 17 °E.
- To prevent sticking, only touch detergents in a water-soluble pouch with dry hands and only ever place them in a dry detergent dispenser.
- Even if the rinse aid and special salt refill indicators light up, washing programmes will run properly with combined detergents.
- The function of rinse aid is limited with combined detergents. You will generally get better results using rinse aid.
- Use tablets with a special drying performance.

## Adding detergent

1. To open the detergent dispenser, press the locking latch.

2. Add the detergent to the dry detergent dispenser.



If you are using tablets, one is enough. Insert the tablets in a horizontal position.

If you are using powder or liquid detergent, follow the manufacturer's instructions and quantities for dosage in the detergent dispenser.

3. Close the lid of the detergent dispenser.

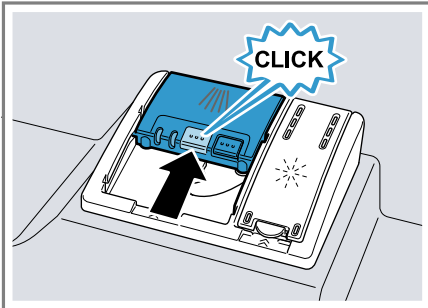

- ✓ The lid clicks into position.
- ✓ The detergent dispenser will open automatically at the optimum time during the programme. Powder or liquid detergent will spread around the washing tank and dissolve there. Tablets will fall into the appliance and dissolve.

**Tip:** If you use powder detergent and select a program with pre-rinse, you can also add a little detergent to the interior door of the appliance.

## Tableware

Only clean tableware that is suitable for dishwashers.

**Note:** Decorated glassware and parts made of aluminium or silver may fade or discolour with dishwashing. Delicate types of glass may turn cloudy after a few washing cycles.

### Damage to glass and tableware

Only put glasses and china in the dishwasher if it is marked as dishwasher-safe by the manufacturer. Avoid damage to glass and tableware.

Cause	Recommendation
<p>The following tableware is not dishwasher-safe:</p> <ul style="list-style-type: none"> <li>■ Items of cutlery and tableware made from wood</li> <li>■ Decorated glassware, antique and hand-crafted tableware</li> <li>■ Plastic parts not resistant to heat</li> <li>■ Tableware made from copper or tin</li> <li>■ Tableware soiled with ash, wax, lubricating grease or paint</li> <li>■ Very small items of tableware</li> </ul>	<p>Only put tableware in the dishwasher if it is marked as dishwasher-safe by the manufacturer.</p>
<p>The chemical composition of detergent causes damage.</p>	<p>Use a detergent marked by the manufacturer as gentle on tableware.</p>

Cause	Recommendation
Highly caustic alkaline or highly acidic cleaning solutions, in particular commercial or industrial cleaners, are not safe to use in the dishwasher with aluminium.	If you are using highly caustic alkaline or highly acidic cleaning agents, in particular commercial or industrial cleaning agents, do not put aluminium parts in the dishwasher interior.
The water temperature of the programme is too high.	Select a programme with lower temperatures. After the programme has ended, take glassware and cutlery out of the appliance without delay.

## Arrange tableware

Arrange tableware correctly to optimise the dishwashing result and prevent damage to both the appliance and tableware.

### Tips

- Using the appliance allows you to save energy and water compared to washing-up by hand.
- See our website for examples of how to load your appliance efficiently, free of charge.
- To save energy and water, load the machine with the number of place settings specified (standard load with tableware and cutlery).  
→ "Technical specifications",  
Page 48

- For better washing and drying results, position items with curves or recesses at an angle so water can run off.

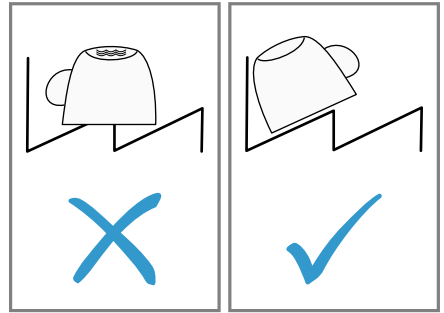

1. Remove large remnants of food from tableware.  
To save resources, do not pre-rinse tableware under running water.
2. Observe the following when arranging tableware:
  - To prevent damage to tableware, arrange it so it is stable and cannot tip over.
  - To prevent injury, arrange cutlery with the points and sharp edges facing down.
  - Position containers with the openings facing down so no water can collect in them.
  - Do not block the spray arm so it can still turn.

## Removing tableware

### **WARNING** **Risk of injury!**

Hot tableware can cause burns to the skin. When hot, tableware is sensitive to shock, may crack and can result in injury.

- ▶ When the programme has ended, do not empty the appliance until the tableware has cooled down for a while.

- ▶ Check the washing tank and accessories for soiling and clean if necessary.  
→ "Cleaning and servicing",  
Page 31

## Basic operation

### Opening appliance door

1. If the childproof lock<sup>1</sup> is not activated, open the appliance door.
2. If the childproof lock<sup>1</sup> is activated, press the catch of the lock to the right ① and open the appliance door ②.

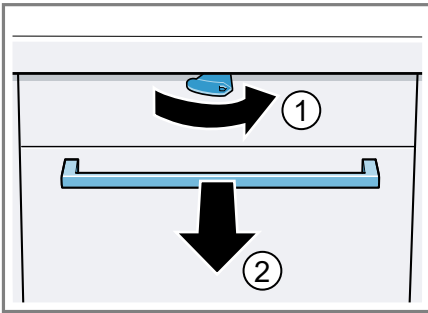

### Switching on the appliance

- ▶ Press ①.  
The Eco 50° programme is set by default.  
The Eco 50° programme is an especially environmentally friendly programme and ideal for normally soiled tableware. It is the most efficient programme for the combination of energy/water consumption for this type of tableware and evidences conformity with the EU Eco-design Directive.

If you do not perform any actions on the appliance for 15 minutes, the appliance will automatically switch off.

### Setting a programme

To adjust the wash cycle to the soiling level of the tableware, select a suitable programme.

- ▶ Turn the programme selector until the right programme has been selected.
- ✓ The programme is set and the LED flashes.

### Setting additional functions

You can set additional functions to complete the washing programme selected.

**Note:** The additional functions which can be used depend on the programme selected.

- ▶ Press the button for the relevant additional function.
- ✓ The additional function is set and the additional function button flashes.

### Setting timer programming<sup>1</sup>

You can delay the start of the programme by 3, 6 or 9 hours.

1. Press ① repeatedly until the relevant display lights up.
2. To activate timer programming, press Start.

**Note:** To deactivate timer programming, press ① repeatedly until none of the displays 3h, 6h or 9h light up.

<sup>1</sup> Depending on the appliance specifications

## Starting the programme

- ▶ Press Start.
- ✓ The programme has ended when no indicators on the controls light up.

### Notes

- You can only change a programme when running if you cancel it.  
→ *"Terminate programme", Page 30*
- The appliance switches off automatically 1 minute after the end of the programme to save energy. If you open the appliance door immediately after the programme has ended, the appliance will switch off after 4 seconds.

## Interrupting programme

**Note:** When you open the appliance door once the appliance has heated up, leave the door slightly ajar for a few minutes and then close it. This will help prevent excess pressure building up in the appliance and stop the appliance door bursting open.

1. Press ①.
- ✓ The programme is saved and the appliance switches off.
2. Press ① to resume the programme.

## Terminate programme

To end a programme early or to switch from a programme that has already started, you will need to cancel it first.

- ▶ Press Reset 3 sec. for approx. 3 seconds.
- ✓ The programme is cancelled and ends after approx. 1 minute.

## Switching off appliance

1. Please note the information on "Safe use" → *Page 10*.
2. Press ①.
3. To prevent damage from dripping water, turn the water tap off tight (not applicable to appliances with Aqua-Stop).

**Tip:** If you press ① during the wash cycle, the programme currently running will be interrupted. When you switch the appliance back on, the programme continues automatically.

## Basic settings

You can configure the basic settings for your appliance to meet your needs.





### Overview of basic settings

The basic settings depend on the features of your appliance.

Basic setting	Selection	Description
Water hardness	Scale with 4 levels	Set the water hardness. → "Setting water softening system", Page 21
Rinse aid disp.	Scale with 4 levels	Set the amount of rinse aid to be dispensed or switch off. → "Setting the amount of rinse aid", Page 24
Extra Dry	On Off <sup>1</sup>	Switch ExtraDry on or off for each operation. For a better drying result the temperature in the final rinse is increased. This may increase the run time slightly. <b>Note:</b> Please take care with delicate tableware. → "Setting Intensive drying", Page 31

<sup>1</sup> Factory setting (may vary according to model)

### Setting Intensive drying

1. Press .
  2. Press and hold Start.
  3. Turn the programme selector until  flashes.
  4. Release the button.
  5. Turn the programme selector until the right level has been set.
    - If the LED  lights up, Intensive drying is switched on.
    - If the LED  does not light up, Intensive drying is switched off.
  6. Press Start to save the setting.
- ✓ The LEDs go out.

## Cleaning and servicing

To keep your appliance working efficiently for a long time, it is important to clean and maintain it carefully.

### Cleaning the tub

#### **WARNING** **Risk of harm to health!**

Using detergents containing chlorine may result in harm to health.

- ▶ Never use detergents containing chlorine.

1. Remove any coarse soiling in the interior with a damp cloth.

## en Cleaning and servicing

2. Add detergent to the detergent dispenser.
3. Select the programme with the highest temperature.
4. "Start the programme without tableware." → Page 30

### Self-cleaning interior<sup>1</sup>

To remove deposits, the appliance self-cleans the interior at regular intervals.

The programme sequence is automatically adjusted for self-cleaning, e.g. the cleaning temperature is briefly increased. Consumption values, e.g. water and electricity, may also increase.

If the interior is no longer self-cleaned adequately and deposits occur, see this information:

→ "Cleaning the tub", Page 31.

### Cleaning products

Only use suitable cleaning products to clean your appliance.

→ "Safe use", Page 10

### Tips on appliance care

Follow the tips on appliance care to make sure your appliance functions properly at all times.

Action	Benefit
Wipe the door seals, the front of the dishwasher and the control panel regularly using a damp cloth and washing-up liquid.	This ensures the parts of the appliance will remain clean and hygienic.
If the appliance is not going to be used for a while, leave the door slightly ajar.	This will prevent unpleasant odours.

### Filter system

The filter system removes coarse soiling from the dishwasher cycle.

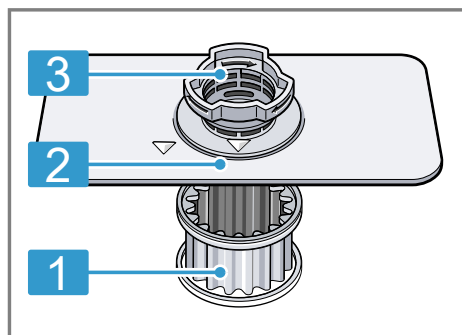

- 1 Micro filter
- 2 Fine filter
- 3 Coarse filter

### Cleaning filters

Soiling in the dishwasher water may block the filters.

1. After each wash check the filters for residue.
2. Turn the coarse filter anticlockwise ① and remove the filter system ②.
  - Check that no foreign objects fall into the sump.

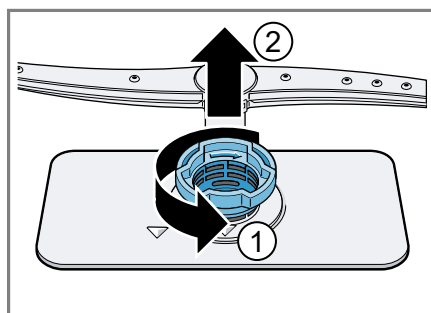

<sup>1</sup> Depending on the appliance specifications



3. Pull down the micro filter to remove.

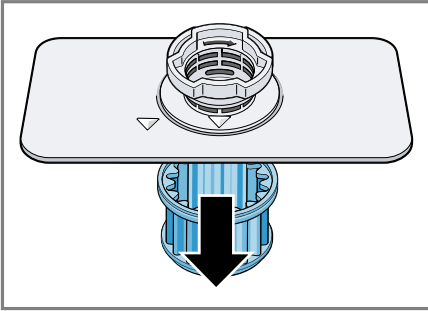

4. Press the locking catches ① together and lift the coarse filter out ②.

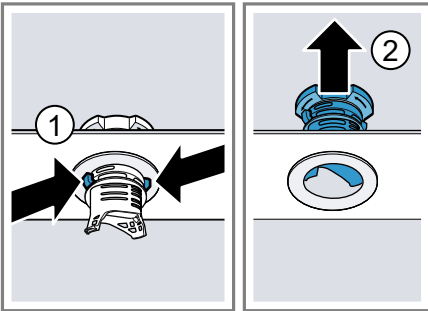

5. Clean the filter elements under running water.  
Carefully clean the rim of dirt between the coarse and the fine filter.
6. Re-assemble the filter system.  
Make sure that the locking catches on the coarse filter click into position.
7. Insert the filter system into the appliance and turn the coarse filter clockwise.  
Make sure that the arrow markings match up.

## Cleaning the spray arm

Limescale and soiling in the dish-washing water may block the nozzles and bearing of the spray arm. Clean the spray arm regularly.

1. Pull up the spray arm to remove.

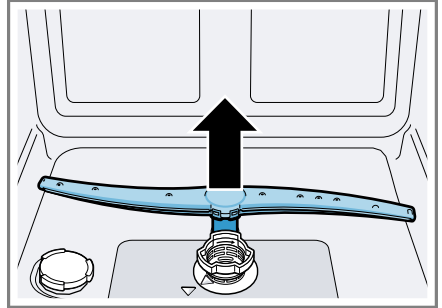

2. Check the outlet nozzles on the spray arm for blockages under running water and remove any foreign objects.
3. Insert the spray arm.  
✓ The spray arm clicks into position.

## Troubleshooting

You can rectify minor faults on your appliance yourself. Read the troubleshooting information before contacting after-sales service. This will avoid unnecessary costs.

### **WARNING**

#### **Risk of electric shock!**

Incorrect repairs are dangerous.

- ▶ Repairs to the appliance should only be carried out by trained specialist staff.
- ▶ Only use genuine spare parts when repairing the appliance.
- ▶ If the power cord of this appliance is damaged, it must be replaced with a special connection cable, which is available from the manufacturer or his Customer Service.



## Appliance safety

<b>Fault</b>	<b>Cause</b>	<b>Troubleshooting</b>
Appliance door will not open or cannot be opened easily.	Childproof lock is activated.	▶ "Open the appliance door." → <i>Page 29</i>

## Error code / Fault display / Signal

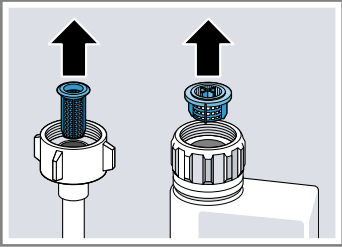
<b>Fault</b>	<b>Cause</b>	<b>Troubleshooting</b>
Display for water supply lights up	Supply hose is kinked.	▶ Install the supply hose without kinks.
	Water tap is turned off.	▶ Turn on the water tap.
	Water tap is jammed or furred up.	▶ Turn on the water tap.
	The filters in the water connection of the supply or AquaStop hose are blocked.	<ol style="list-style-type: none"> <li>1. Switch off the appliance.</li> <li>2. Pull out the mains plug.</li> <li>3. Turn off the water tap.</li> <li>4. Unscrew the water connection.</li> </ol>

Fault	Cause	Troubleshooting
Display for water supply lights up		<p>5. Remove the filter from the supply hose</p>  <p>6. Clean the filter.</p> <p>7. Re-insert the filter in the supply hose.</p> <p>8. Screw the water connection back on.</p> <p>9. Check the water connection for leaks.</p> <p>10. Restore the power supply.</p> <p>11. Switch the appliance on.</p>
	Filters are soiled or blocked.	<p>▶ Clean the filters. → "Cleaning filters", Page 32</p>
	Wastewater hose is blocked or kinked.	<p>1. Reposition the wastewater hose without kinks.</p> <p>2. Remove residues.</p>
	Siphon connection is still sealed.	<p>▶ Check the connection to the siphon and open if necessary.</p>
	Cover of the wastewater pump is loose.	<p>▶ Secure the cover of the "Wastewater pump" → Page 46 so it clicks into position.</p>

Fault	Cause	Troubleshooting
Display "Check water supply" flashes	A technical fault is present.	<ol style="list-style-type: none"> <li>1. Press .</li> <li>2. Unplug the appliance or switch off the fuse.</li> <li>3. Wait at least 2 minutes.</li> <li>4. Insert the mains plug of the appliance in a socket or switch on the fuse.</li> <li>5. Switch the appliance on.</li> <li>6. If the problem occurs again:               <ul style="list-style-type: none"> <li>- Press .</li> <li>- Turn off the water tap.</li> <li>- Pull out the mains plug.</li> <li>- Contact "Customer Service" → <i>Page 47</i> and give the error code.</li> </ul> </li> </ol>
Displays flash	Appliance door is not closed properly.	<ul style="list-style-type: none"> <li>▶ Close the appliance door.           <ul style="list-style-type: none"> <li>- Arrange the tableware so that no parts project beyond the basket and prevent the appliance door from closing properly.</li> </ul> </li> </ul>

## Washing results

Fault	Cause	Troubleshooting
Tableware is not dry.	No rinse aid used or dosage set too low.	<ol style="list-style-type: none"> <li>1. Add "Rinse aid" → <i>Page 24</i>.</li> <li>2. Set the amount of rinse aid to be dispensed.</li> </ol>
	Programme or programme option has no drying phase, or the drying phase is too brief.	<ul style="list-style-type: none"> <li>▶ Select a programme with drying, e.g. intensive, strong or ECO programme.</li> </ul> <p>Some option buttons decrease the drying result, e.g. varioSpeed.</p>

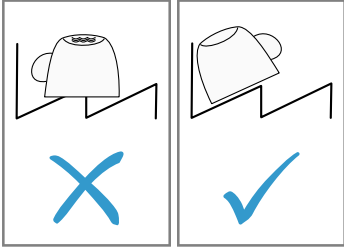
<b>Fault</b>	<b>Cause</b>	<b>Troubleshooting</b>
Tableware is not dry.	Water collects in recesses of the tableware or cutlery.	<p>▶ Position tableware at an angle where possible.</p> 
	The combined detergent used has a poor drying performance.	<ol style="list-style-type: none"> <li>1. Use rinse aid to improve drying performance.</li> <li>2. Use a different combined detergent with a better drying performance.</li> </ol>
	Extra Dry not activated to improve drying performance.	▶ Activate Extra Dry.
	Tableware removed too early or drying process not yet ended.	<ol style="list-style-type: none"> <li>1. Wait until the programme ends.</li> <li>2. Only remove tableware 30 minutes after the programme has ended.</li> </ol>
	Rinse aid used has a limited drying performance.	▶ Use a name-brand rinse aid. Eco products may have limited effectiveness.
Plastic tableware is not dry.	Not a fault. As plastic does not store heat so well, it also does not dry as well.	▶ No remedial action possible.
Cutlery is not dry.	Cutlery not arranged properly in the cutlery basket or cutlery drawer.	<p>Droplets can form on the cutlery contact points.</p> <ol style="list-style-type: none"> <li>1. "Arrange cutlery individually where possible." → <i>Page 28</i></li> <li>2. Avoid points of contact.</li> </ol>
Appliance interior still wet after wash cycle.	Not a fault. The condensation drying principle causes water droplets in the tub – they are indeed desirable here. The moisture in the air condenses on the inside walls, runs off and is pumped out.	No action required.

Fault	Cause	Troubleshooting
Remnants of food on tableware.	Tableware is placed too close together or basket is overfilled.	<ol style="list-style-type: none"> <li>1. Arrange tableware with sufficient space in between. The spray jets must reach the surfaces of the tableware.</li> <li>2. Avoid points of contact.</li> </ol>
	Spray arm rotation is blocked.	▶ Arrange tableware so that it does not obstruct spray arm rotation.
	Spray arm nozzles are blocked.	▶ Clean the Spray arms.
	Filters are soiled.	▶ Clean the filters. → <i>"Cleaning filters", Page 32</i>
	Filters are inserted incorrectly and/or not engaged.	<ol style="list-style-type: none"> <li>1. Insert the filters properly. → <i>"Filter system", Page 32</i></li> <li>2. Engage the filters.</li> </ol>
	Washing programme selected too weak.	▶ Select a more intensive washing programme.
	Tableware has been pre-cleaned too intensely. The sensors chose a weaker programme. Stubborn soiling cannot be entirely removed.	▶ Only remove large remnants of food and do not pre-rinse tableware.
	Tall narrow receptacles in corner areas are not rinsed adequately.	▶ Do not position tall narrow receptacles at too great an angle or in corner areas.
	Top baskets on right and left are not set to same height.	▶ Set the top baskets on the left and right to the same level.
Detergent residue in the appliance	Lid of the detergent dispenser is blocked by items of tableware parts and will not open.	<ol style="list-style-type: none"> <li>1. Arrange tableware in the top basket tableware so the tab collecting tray is not obstructed by tableware. → <i>"Arrange tableware", Page 28</i> Items of tableware are blocking the dispenser lid.</li> <li>2. Do not place tableware or fragrance dispensers in the tablet collecting tray.</li> </ol>
	The lid of the detergent dispenser is blocked by the tab and will not open.	▶ Position the tab in the detergent dispenser crosswise, not vertically.

<b>Fault</b>	<b>Cause</b>	<b>Troubleshooting</b>
Detergent residue in the appliance	<p>▶ Tabs are used in the quick or short programme. Dissolving time of the tab is not attained.</p>	<p>▶ Select a more intensive Programme or use "Powder detergent" → <i>Page 25</i>.</p>
	<p>▶ Washing effect and dissolving performance are reduced after a prolonged storage time or detergent is very lumpy.</p>	<p>▶ Change your "detergent" → <i>Page 25</i>.</p>
Water marks on plastic parts.	<p>▶ Due to laws of physics droplet formation on plastic surfaces is unavoidable. After drying water marks are visible.</p>	<p>▶ Select a more intensive programme.</p> <p>▶ Position tableware at an angle. → <i>"Arrange tableware", Page 28</i></p> <p>▶ Use rinse aid. → <i>"Rinse aid", Page 24</i></p> <p>▶ Set the water softening system higher.</p>
Wipeable or water-soluble coatings are present inside the appliance or on the door.	<p>▶ Detergent substances are deposited there. These coatings cannot generally be removed with chemicals.</p>	<p>▶ Change your "detergent" → <i>Page 25</i>.</p> <p>▶ Clean the appliance mechanically.</p>
	<p>▶ White coating is deposited in the appliance interior.</p>	<p>1. Set the water softening system correctly. In most cases you will need to increase the setting.</p> <p>2. Change your detergent if required.</p>
	<p>▶ Special salt dispenser is not screwed tight.</p>	<p>▶ Screw the special salt dispenser tight.</p>
Stubborn white coatings are present on tableware, inside the appliance or the door.	<p>▶ Detergent substances are deposited there. These coatings cannot generally be removed with chemicals.</p>	<p>▶ Change your "detergent" → <i>Page 25</i>.</p> <p>▶ Clean the appliance mechanically.</p>
	<p>▶ The hardness range is set incorrectly or the water hardness is greater than 44 °E (6,2 mmol/l).</p>	<p>▶ Set the "Water softening system" → <i>Page 21</i> to the water hardness or add special salt.</p>
	<p>▶ 3in1/organic/eco detergent is not effective enough.</p>	<p>▶ Set the "Water softening system" → <i>Page 21</i> to the water hardness and use separate detergents (proprietary detergent, special salt, rinse aid).</p>

Fault	Cause	Troubleshooting
Stubborn white coatings are present on tableware, inside the appliance or the door.	Too little detergent is being used.	▶ Increase the amount of detergent used or change "Detergent " → <i>Page 25</i> .
	Washing programme selected too weak.	▶ Select a more intensive washing programme.
Tea residue or lipstick marks on tableware.	Washing temperature is too low.	▶ Select a programme with a higher washing temperature.
	Too little detergent is being used or is unsuitable.	▶ Use a suitable "Detergent " → <i>Page 25</i> and follow the manufacturer's instructions for the amount to be used.
	Tableware has been pre-cleaned too intensely. The sensors chose a weaker programme. Stubborn soiling cannot be entirely removed.	▶ Only remove large remnants of food and do not prerinse tableware.
Coloured coatings (blue, yellow, brown) that are difficult or impossible to remove are present inside the appliance or on stainless steel tableware.	The formation of films is due to substances contained in vegetables (cabbage, celery, potatoes, noodles, etc.) or tap water (manganese).	▶ Clean the appliance. You can remove deposits with "Mechanical cleaning" → <i>Page 31</i> or a machine cleaning product. It may not always be possible to completely remove deposits but they are harmless to health.
	The formation of films is due to metal components on silver or aluminium tableware.	▶ Clean the appliance. You can remove deposits with "Mechanical cleaning" → <i>Page 31</i> or a machine cleaning product. It may not always be possible to completely remove deposits but they are harmless to health.
Coloured deposits (yellow, orange, brown) that are easy to remove are present inside the appliance (mainly at the bottom).	The formation of films is due to ingredients of food remnants and tap water (limescale) "soaplike".	<ol style="list-style-type: none"> <li>1. Check the setting of the water softening system.</li> <li>2. Add special salt. → <i>"Adding special salt", Page 22</i></li> <li>3. If you are using combined detergents (tabs), activate the water softening system. Follow the information about detergents. → <i>"Information on detergents", Page 26</i></li> </ol>



<b>Fault</b>	<b>Cause</b>	<b>Troubleshooting</b>
Plastic parts inside the appliance are discoloured.	Plastic parts inside the appliance may become discoloured during the life of the dishwasher.	▶ Discolouration can come about and will not impair functioning of the appliance.
Plastic parts are discoloured.	Washing temperature is too low.	▶ Select a programme with a higher washing temperature.
	Tableware has been pre-cleaned too intensely. The sensors chose a weaker programme. Stubborn soiling cannot be entirely removed.	▶ Only remove large remnants of food and do not prerinse tableware.
Removable streaks are present on glasses, glassware with a metallic appearance and cutlery.	Amount of rinse aid to be dispensed is set too high.	▶ Set the rinse aid system to a lower setting.
	No rinse aid has been added.	▶ → <i>"Adding rinse aid", Page 24</i>
	Detergent residue is present in the final rinse. Lid of the detergent dispenser is blocked by tableware items and will not open fully.	<ol style="list-style-type: none"> <li data-bbox="664 628 1050 740">1. Arrange tableware in the top basket tableware so the tab collecting tray is not obstructed by tableware. → <i>"Arrange tableware", Page 28</i> Items of tableware are blocking the dispenser lid.</li> <li data-bbox="664 820 1050 900">2. Do not place tableware or fragrance dispensers in the tablet collecting tray.</li> </ol>
	Tableware has been pre-cleaned too intensely. The sensors chose a weaker programme. Stubborn soiling cannot be entirely removed.	▶ Only remove large remnants of food and do not prerinse tableware.

Fault	Cause	Troubleshooting
Irreversible clouding of glassware.	Glasses are not dishwasher-proof, only suitable for dishwashers.	<ul style="list-style-type: none"> <li>▶ Use dishwasher-proof glasses. Glasses are usually only suitable for use in a dishwasher, i.e. long-term wear or long-term changes must be expected.</li> <li>▶ Avoid a lengthy steam phase (standing time after wash cycle ends).</li> <li>▶ Use a programme with a lower temperature.</li> <li>▶ Set the softening system to the water hardness.</li> <li>▶ Use detergent with a glass protection component.</li> </ul>
Rust spots on cutlery.	Cutlery is not sufficiently rust-resistant. Knife blades are often more severely affected.	▶ Use rust-resistant tableware.
	Cutlery may also rust if washed together with rusting items.	▶ Do not wash rusting items.
	Salt content in washing water is too high.	<ol style="list-style-type: none"> <li>1. Remove any spilled special salt from the tub.</li> <li>2. Screw the cap of the special salt dispenser on tight.</li> </ol>
Detergent residue is present in the detergent dispenser or the tablet collecting tray.	Spray arms were blocked by tableware so detergent was not rinsed out.	▶ Check that the spray arms are not blocked and can rotate freely.
	Detergent dispenser was damp when detergent was added.	▶ Only add detergent to a detergent dispenser when dry.
Excessive formation of foam occurs.	Hand washing-up liquid is present in dispenser for rinse aid.	▶ Immediately add rinse aid to the dispenser. → <i>"Adding rinse aid"</i> , Page 24
	Rinse aid has been spilled.	▶ Remove the rinse aid with a cloth.
	Detergent or appliance care product used causes excessive foaming.	▶ Change the brand of detergent.

## Information on display panel

Fault	Cause	Troubleshooting
Special salt refill indicator lights up.	Insufficient special salt. Sensor does not detect special salt tablets.	▶ Add "Special salt" → <i>Page 22</i> . ▶ Do not use special salt tablets.
Refill indicator for special salt does not light up.	Water softening system is switched off.	▶ "Setting the water softening system" → <i>Page 21</i>
Refill indicator for rinse aid lights up.	Insufficient rinse aid.	1. Add "Rinse aid" → <i>Page 24</i> . 2. Set the amount of rinse aid to be dispensed.
Refill indicator for rinse aid does not light up.	Rinse aid system is switched off.	▶ Set the amount of rinse aid to be dispensed. → " <i>Setting the amount of rinse aid</i> ", <i>Page 24</i> → " <i>Setting the amount of rinse aid</i> ", <i>Page 24</i>

## Malfunctions

Fault	Cause	Troubleshooting
Water is left in the appliance at the end of the programme.	Filter system or area under the filters is blocked.	1. Clean the "Filters" → <i>Page 32</i> . 2. Clean the "Wastewater pump" → <i>Page 46</i> .
	Programme has not yet ended.	▶ Wait until the programme ends or cancel the programme with <b>Reset</b> . ▶ → " <i>Terminate programme</i> ", <i>Page 30</i>
Appliance cannot be switched on or operated.	Appliance functions have failed.	1. Pull out the mains plug or switch off the fuse. 2. Wait at least 2 minutes. 3. Connect the appliance to the power supply. 4. Switch the appliance on.
Appliance does not start.	The mains fuse has tripped.	▶ Check the relevant fuse.
	Mains cable is not inserted.	1. Check whether the socket works. 2. Check whether the mains cable is properly inserted in the socket and on the rear of the appliance.
	Appliance door is not closed properly.	▶ Close the appliance door.

<b>Fault</b>	<b>Cause</b>	<b>Troubleshooting</b>
Programme starts automatically.	You did not wait until programme ended.	▶ → "Terminate programme", Page 30
Appliance stops during the programme or cuts out.	Appliance door is not closed properly.	▶ Close the appliance door.
	Power and/or water supply has been interrupted.	1. Check the power supply. 2. Check the water supply.
	Top basket is pressing against inner door and preventing appliance door from being closed securely.	▶ Check whether the rear panel of the appliance is being pressed in by a socket or hose holder that has not been removed.  ▶ Arrange the tableware so that no parts project beyond the basket and prevent the appliance door from closing properly.
Basic settings cannot be changed.	A programme is currently running. Changing basic settings is only possible at the start of a programme.	

## Mechanical damage

<b>Fault</b>	<b>Cause</b>	<b>Troubleshooting</b>
Appliance door cannot be closed.	Door lock has been activated.	▶ Close the appliance door with greater force.
	Door cannot be closed due to installation method.	▶ Check whether the appliance has been installed properly.  When closed, the appliance door, its decor or attached parts should not knock against adjacent cabinets or the worktop.
Lid on the detergent dispenser cannot be closed.	Detergent dispenser or lid are blocked by sticky detergent residue.	▶ Remove detergent residue.

## Noise

<b>Fault</b>	<b>Cause</b>	<b>Troubleshooting</b>
Filling valves making knocking noises.	Caused by the domestic installation. No appliance fault present. Does not affect functioning of the appliance.	▶ Can only be remedied in the domestic installation.

<b>Fault</b>	<b>Cause</b>	<b>Troubleshooting</b>
Knocking or rattling noise.	Spray arm is striking tableware.	▶ Arrange tableware so that the spray arms do not strike tableware.
	With a small load the water jets directly strike against the tub.	▶ Distribute the tableware evenly. ▶ Load the appliance with more tableware.
	Light items of tableware move about during the wash cycle.	▶ Position light items of tableware securely.

## Clean wastewater pump

Large remnants of food or foreign bodies can block the waste water pump. As soon as the rinsing water no longer drains properly, the waste water pump must be cleaned.

### **WARNING** **Risk of injury!**

Sharp and pointed objects or fragments of glass may block the waste water pump and cause injury.

- ▶ Remove any foreign bodies carefully.
1. Disconnect the appliance from the power supply.
  2. Remove the basket.
  3. Remove the filter system.
  4. Scoop out any water.  
Use a sponge if necessary.
  5. Loosen the screws on the pump cover (Torx T 20).

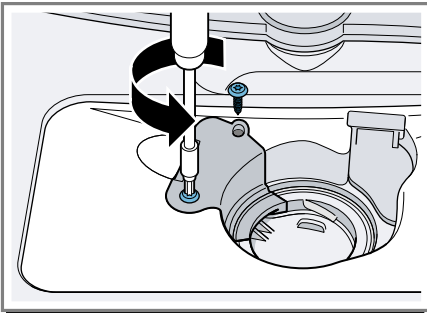

6. Pull up and remove the pump cover.

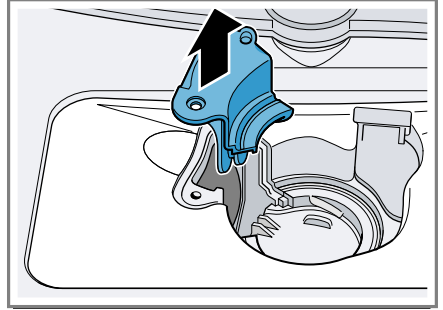

7. Remove any remnants of food and foreign bodies in the interior.
8. Insert the pump cover, press down and screw firmly in place.
9. Install the filter system.
10. Insert the basket.

---

## Transportation, storage and disposal

You can find out here how to prepare your appliance for transportation and storage. You will also find out how to dispose of old appliances.

### Removing the appliance

1. Disconnect the appliance from the mains power supply.
2. Turn off the water tap.
3. Detach the drainage connection.
4. Detach the drinking water connection.
5. Pull the appliance out carefully, along with the hose behind it.

## Protect appliance from frost

If there is a risk of frost where the appliance will be standing, e.g. in a holiday home, empty the appliance completely.

- ▶ Empty the appliance.  
→ *"Transporting the appliance"*,  
Page 47

## Transporting the appliance

To avoid damage to the appliance, empty it before transporting.

**Note:** Always transport the dishwasher upright to prevent residual water getting into the machine's controls and damaging the appliance.

1. Remove tableware from the appliance.
2. Secure loose parts.
3. Turn on the water tap.
4. "Switch on the appliance."  
→ Page 29
5. Select the programme with the highest temperature.
6. "Start the programme." → Page 30
7. To drain the appliance, terminate the programme after approx. 4 minutes.  
→ *"Terminate programme"*,  
Page 30
8. "Switch off the appliance."  
→ Page 30
9. Turn off the water tap.
10. To empty the residual water out of the appliance, detach the supply hose and let the water drain out.

## Disposing of old appliance

Valuable raw materials can be re-used by recycling.

### WARNING

#### Risk of harm to health!

Children can lock themselves in the appliance, thereby putting their lives at risk.

- ▶ With redundant appliances, unplug the power cord. Then cut through the cord and damage the lock on the appliance door beyond repair so that the appliance door will no longer close.

1. Unplug the appliance from the mains.
2. Cut through the power cord.
3. Dispose of the appliance in an environmentally friendly manner.

Information about current disposal methods are available from your specialist dealer or local authority.



This appliance is labelled in accordance with European Directive 2012/19/EU concerning used electrical and electronic appliances (waste electrical and electronic equipment - WEEE). The guideline determines the framework for the return and recycling of used appliances as applicable throughout the EU.

## Customer Service

If you have any queries, are unable to rectify faults on the appliance yourself or if your appliance needs to be repaired, contact Customer Service. Function-relevant genuine spare parts according to the corresponding Eco-design Order can be obtained from Customer Service for a period of at

## en Technical specifications

least 10 years from the date on which your appliance was placed on the market within the European Economic Area.

**Note:** Under the terms of the manufacturer's warranty the use of Customer Service is free of charge.

Detailed information on the warranty period and terms of warranty in your country is available from our after-sales service, your retailer or on our website.

If you contact Customer Service, you will require the product number (E-Nr.) and the production number (FD) of your appliance.

The contact details for Customer Service can be found in the enclosed Customer Service directory or on our website.

### Product number (E-Nr.) and production number (FD)

You can find the product number (E-Nr.) and the production number (FD) on the appliance's rating plate.

The rating plate is located inside the appliance door.

Make a note of your appliance's details and the Customer Service telephone number to find them again quickly.

---

## Technical specifications

Weight	Max.: 24 kg
Voltage	220 - 240 V, 50 Hz or 60 Hz
Power rating	2000 - 2400 W
Fuse	10 - 16 A

Water pressure	■ Min. 0.05 MPa (0.5 bar) ■ Max. 1 MPa (10 bar)
Inlet rate	Min. 10 l/min
Water temperature	Cold water: 25 °C
Capacity	6 place settings

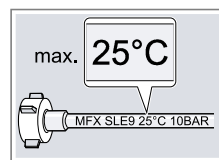

You can find more information about your model online at <https://eprel.ec.europa.eu/><sup>1</sup>. This web address is linked to the official EU EPREL product database. Please then follow the instructions on searching for the model. The model identifier is made up of the characters before the slash in the product number (E-Nr.) on the rating plate. Alternatively, you can also find the model identifier in the first line of the EU energy label.

---

<sup>1</sup> Only applies to countries in the European Economic Area











## Thank you for buying a Bosch Home Appliance!

Register your new device on MyBosch now and profit directly from:

- **Expert tips & tricks for your appliance**
- **Warranty extension options**
- **Discounts for accessories & spare-parts**
- **Digital manual and all appliance data at hand**
- **Easy access to Bosch Home Appliances Service**

Free and easy registration – also on mobile phones:

**[www.bosch-home.com/welcome](http://www.bosch-home.com/welcome)**

**BOSCH**  
HOME APPLIANCES  
**SERVICE**

## Looking for help? You'll find it here.

Expert advice for your Bosch home appliances, help with problems or a repair from Bosch experts.

Find out everything about the many ways Bosch can support you:

**[www.bosch-home.com/service](http://www.bosch-home.com/service)**

Contact data of all countries are listed in the attached service directory.

**Robert Bosch Hausgeräte GmbH**

Carl-Wery-Straße 34

81739 München

GERMANY

[www.bosch-home.com](http://www.bosch-home.com)

Valid within Great Britain:

Imported to Great Britain by

BSH Home Appliances Ltd.

Grand Union House

Old Wolverton Road

Wolverton, Milton Keynes

MK12 5PT

United Kingdom



**9001438529** (011006) 550 EA

en