



SIEMENS



Tumble dryer

WT47X940EU

siemens-home.bsh-group.com/welcome

en Installation and operating instructions

Register
your
product
online

Your new tumble dryer

You have opted for a tumble dryer manufactured by Siemens.

Please take a few minutes to read and become familiar with the advantages of your tumble dryer.

To meet the high quality demands required by Siemens, every tumble dryer that leaves our factory is carefully checked to ensure that it functions correctly and is in perfect condition.

For more information on our products, accessories, replacement parts and services, see our website www.siemens-home.bsh-group.com or contact our Customer Service centres.

If the operating and installation instructions describe different models, any differences will be pointed out at the relevant points in the text.



Read these operating and installation instructions before operating the tumble dryer.

Display rules

Warning!

This combination of symbol and signal word indicates a possibly dangerous situation. Not heeding the warning can cause death or injuries.

Caution!

This signal word indicates a possibly dangerous situation. Not heeding the caution can cause property and/or environmental damage.

Note/tip

Information about the optimum use of the appliance/any other useful information.











1. 2. 3. / a) b) c)





The steps are represented by numbers or letters.









■ / -

Lists are represented by a small box or a dash.

Table of contents

	Intended use	4
	Safety instructions	5
	Children/people/pets	5
	Installation	6
	Operation	9
	Cleaning/Maintenance	11
	Energy-saving tips	13
	Installing and connecting the appliance	13
	Included with the appliance:	13
	Installing the appliance	14
	Connecting the appliance	15
	Before using the appliance for the first time	17
	Optional accessories	17
	Quick reference guide	18
	Familiarising yourself with your appliance	19
	Appliance overview	19
	Panel	20
	Display	21
	Display overview	21
	Operating logic	22
	What the symbols mean	23
	What the colours mean	23
	Information in the display	24
	Overview of programmes	26
	Programme settings	28
	Programme management	29
	Programme configuration	30
	Additional functions	31
	Laundry	32
	Preparing the laundry	32
	Sorting laundry	32

	Operating the appliance	33
	Switching on the appliance	33
	Opening the door	33
	Placing the laundry into the drum	34
	Closing the door	34
	Setting a programme	35
	Starting a programme	35
	Programme progress	35
	Adding more laundry or removing laundry	36
	Cancelling the programme	36
	Programme end	36
	Removing laundry and switching off the appliance	36
	Emptying the condensation container	37
	Appliance settings	38
	Childproof lock	38
	Tones	38
	Other appliance settings	38
	Home Connect	42
	Calling up the Home Connect menu	43
	Connecting to the home network and the Home Connect app	43
	Energy management	45
	Status	46
	Activating/deactivating Wi-Fi	46
	Resetting your network settings	46
	Updating the software	46
	Information on data protection	47
	Declaration of Conformity	47
	Drying with the basket for woollens	48
	The basket for woollens	48
	Securing the basket for woollens	48
	Application examples	49
	Putting the insert in place and starting a programme	49

	Draining the condensation water	51
	Cleaning and maintenance ...	54
	Cleaning the appliance	54
	Cleaning the moisture sensor	55
	Cleaning the filter in the condensation container	55
	Cleaning the air channel	56
	Cleaning the base unit.	57
	Appliance care	61
	Preparing the appliance for appliance care	61
	Running the basic appliance care programme	63
	Running the intensive appliance care programme	65
	Help with the appliance	68
	Transporting the appliance ...	71
	Consumption values	72
	Consumption values table	72
	Most efficient programme for cotton laundry	72
	Technical specifications	73
	Disposal	73
	After-sales service	74

Intended use

- This appliance is intended for private domestic use only.
- Do not install or operate this appliance anywhere that is liable to experience frost and/or outdoor conditions. There is a risk that the appliance will be damaged if residual water in it freezes. If hoses freeze up, they may crack/burst.
- This appliance must only be used for drying and freshening up domestic laundry, consisting of items that have been washed with water and are suitable for tumble drying (see label on item). Using the appliance for any other purpose is outside of the scope of its intended application and is forbidden.
- This appliance is intended for use up to a maximum height of 4000 metres above sea level.

Before you switch on the appliance:

Check that there is no visible damage to the appliance. Do not operate the appliance if it is damaged. Should you have any problems, please contact your specialist dealer or our customer service.

Read and follow the operating and installation instructions and all other information provided with this appliance.

Retain the documents for subsequent use or for subsequent owners.

Safety instructions

The following safety information and warnings are provided to protect you from injury and to prevent material damage to your surroundings.

It is nevertheless important to take the necessary precautions and to proceed with care when installing, maintaining, cleaning and operating the appliance.

Children/people/pets

Warning **Risk of death!**

Children and other people who are unable to assess the risks involved when using the appliance may injure themselves or may find themselves in life-threatening situations. Therefore please note:

- The appliance may be used by children over the age of 8 years and by persons with reduced physical, sensory or mental capacity or by persons with a lack of experience or knowledge as long as they are supervised or have received instruction on how to use the appliance safely and they have understood the potential risks of using the appliance.
- Children must not play with this appliance.

- Do not allow children to clean or maintain this appliance unsupervised.
- Keep children under 3 years and pets away from this appliance.
- Do not leave the appliance unattended when children or other people who are unable to assess the risks are in the vicinity.

Warning **Risk of death!**

Children may lock themselves inside appliances and find themselves in a life-threatening situation.

- Do not position the appliance behind a door, as this may obstruct the appliance door or prevent it from opening completely.
- Once an appliance has reached the end of its life, pull the mains plug from the socket **before** severing the mains cable, and then destroy the lock on the appliance door.

 **Warning**

Risk of suffocation!

If allowed to play with the packaging/plastic film or packing components, children may become caught in these or pull them over their heads and suffocate.

Keep packaging, plastic film and packing components away from children.

 **Warning**

Risk of poisoning!

Detergents and care products may result in poisoning if consumed.

If accidentally swallowed, seek medical advice. Keep detergents and care products out of the reach of children.

 **Warning**

Eye/skin irritation!

Contact with detergents or care products may cause eye/skin irritation.

Rinse eyes/skin thoroughly if they/it come(s) into contact with detergents or care products. Keep detergents and care products out of the reach of children.

Installation

 **Warning**

**Risk of electric shock/fire/
material damage/damage to
the appliance!**

If the appliance is not installed properly, this may lead to a dangerous situation. Ensure the following:

- The mains voltage on your power socket must match the rated voltage specified on the appliance (identification plate). The connected loads and the required fuse protection are specified on the identification plate.
- The appliance must not be supplied through an external switching device, such as a timer, or connected to a circuit that is regularly switched on and off by a utility.
- The mains plug and the protective contact socket must match and the earthing system must be correctly installed.
- The installation must have an adequate cross section.

- The mains plug must be freely accessible at all times. If this is not possible, in order to comply with the relevant safety regulations, a switch (all pole disconnection) must be built into the permanent installation in accordance with electrical installation regulations.
- If using a residual current circuit breaker, only use one that bears the following mark: . The presence of this mark is the only way to be sure that it fulfils all the applicable regulations.

⚠ Warning

**Risk of electric shock/fire/
material damage/damage to
the appliance!**

If the appliance's mains cable is altered or damaged, this may result in electric shock, short circuiting or fire due to overheating.

The mains cable must not be kinked, crushed or altered, and must not come into contact with any heat sources.

⚠ Warning

**Risk of fire/material damage/
damage to the appliance!**

The use of extension cords or power strips may result in fire due to overheating or short circuiting.

Connect the appliance directly to an earthed socket that has been correctly installed. Do not use extension cords, power strips or multi-way couplers.

⚠ Warning

**Risk of injury/material
damage/damage to the
appliance!**

- The appliance may vibrate or move when in operation, potentially resulting in injury or material damage. Place the appliance on a clean, even, solid surface and, using a spirit level to guide you, level it with the screw-in feet.

- Incorrectly placing (stacking) this appliance on top of a washing machine may result in injury, material damage and/or damage to the appliance.
If this appliance is to be placed on top of a washing machine, the washing machine must be of at least the same depth and width as the appliance, and it must be secured in place with the appropriate connection set if available. → *Page 17*
The appliance **MUST** be secured with this connection set. Stacking the appliance in any other way is forbidden.
- If you take hold of any of the appliance's protruding parts (e.g. the appliance door) in order to lift or move it, these parts may break off and cause injury.
Do not take hold of any of the appliance's protruding parts in order to move the appliance.

 **Warning**
Risk of injury!

- The appliance is very heavy. Lifting it may result in injury. Do not lift the appliance on your own.
- The appliance has sharp edges on which you could cut your hands. Do not take hold of the appliance by its sharp edges. Wear protective gloves to lift it.
- If the hoses and mains cables are not correctly routed, they may constitute a tripping hazard, which may result in injury. Route hoses and cables such that they do not constitute a tripping hazard.

Operation

Warning

Risk of explosions/fire!

Laundry that has come into contact with solvents, oil, wax, wax remover, paint, grease or stain remover may ignite when dried in the machine, or even cause the appliance to explode. Therefore please note:

- Rinse the laundry thoroughly with warm water and detergent before drying it in the machine.
- Do not place laundry in this appliance to be dried if the laundry has not been washed first.
- Do not use the appliance if industrial chemicals have been used to clean the laundry.

Warning

Risk of explosions/fire!

- If there is any residual material left in the fluff filter, this may ignite when drying is in progress, or even cause the appliance to catch fire or explode. Clean the fluff filter regularly.
- Certain objects may ignite when drying is in progress, or even cause the appliance to catch fire or explode. Remove any lighters or matches from pockets on items of clothing.

- If there is coal dust or flour in the air around the appliance, this may cause an explosion. Make sure that the area around the appliance is kept clean when it is in operation.

Warning

Risk of fire/material damage/ damage to the appliance!

The appliance contains R290, a refrigerant that is environmentally friendly but flammable. Keep open fire and ignition sources away from the appliance.



Warning

Risk of fire/material damage/ damage to the appliance!

If a program is terminated before the drying cycle has finished, this prevents the laundry from cooling down sufficiently and may cause the laundry to ignite, or may result in material damage or damage to the appliance.

- During the last part of the drying cycle, the laundry in the drum is not heated (cooling cycle). This is to ensure that it remains at a temperature at which it will not be damaged.

- Do not switch off the appliance before the drying cycle has finished unless you remove all items of laundry from the drum immediately and spread them out (to dissipate the heat).

⚠ Warning
Risk of poisoning/material damage!

Condensation water is not suitable for drinking and may be contaminated with lint. Contaminated condensation water may be hazardous to health and may cause material damage.
Do not drink or reuse.

⚠ Warning
Risk of poisoning!

Poisonous fumes may be given off by cleaning agents that contain solvents, e.g. cleaning solvent.
Do not use cleaning agents that contain solvents.

⚠ Warning
Risk of injury!

- If you support your weight/sit on the appliance door when it is open, the appliance may tip over, which may result in injury.
Do not support your weight on the appliance door when it is open.

- If you climb onto the appliance, the worktop may break, which may result in injury.
Do not climb onto the appliance.
- If you reach into the drum while it is still rotating, you risk injuring your hands.
Wait until the drum has stopped rotating.

Caution!
Material damage/damage to the appliance

- If the amount of laundry in the appliance exceeds its maximum load capacity, it may not be able to operate properly, or this may result in material damage or damage to the appliance.
Do not exceed the maximum load capacity of dry laundry. Make sure you comply with the maximum load capacities specified for each of the programs. → *Page 26*
- If you operate the appliance without a fluff catcher (e.g. fluff filter, fluff depot, depending on appliance specifications), or if the fluff catcher is incomplete or defective, this may result in damage to the appliance.
Do not operate the appliance without a fluff catcher, or with a fluff catcher that is incomplete or defective.

- Light objects such as hair and lint may be sucked into the air inlet when the appliance is in operation. Keep these away from the appliance.
- Foam and foam rubber may deform or melt if dried in the appliance.
Do not dry laundry items that contain foam or foam rubber in the appliance.
- If you pour the wrong quantity of detergent or cleaning agent into the appliance, this may result in material damage or damage to the appliance.
Use detergents/care products/cleaning agents and softeners in accordance with the manufacturers' instructions.
- If the appliance overheats, it may not be able to operate properly, or this may result in material damage or damage to the appliance.
Make sure that the appliance's air inlet is never obstructed when the appliance is in operation, and that the area around the appliance is adequately ventilated.

Cleaning/Maintenance

Warning **Risk of death!**

The appliance is powered by electricity. There is a risk of electric shock if you come into contact with live components. Therefore please note:

- Switch off the appliance. Disconnect the appliance from the power supply (pull out the plug).
- Never take hold of the mains plug with wet hands.
- When removing the mains plug from the socket, always take hold of the plug itself and never the mains cable, otherwise this may damage the mains cable.
- Do not make any technical modifications to the appliance or its features.
- Repairs and any other work on the appliance must only be conducted by our customer service or by an electrician. The same applies for replacing the mains cable (when necessary).
- Spare mains cables can be ordered from our customer service.

 **Warning**

Risk of poisoning!

Poisonous fumes may be given off by cleaning agents that contain solvents, e.g. cleaning solvent.

Do not use cleaning agents that contain solvents.

 **Warning**

Risk of electric shock/material damage/damage to the appliance!

If moisture penetrates the appliance, this may cause it to short circuit.

Do not use a pressure washer, steam cleaner, hose or spray gun to clean your appliance.

 **Warning**

Risk of injury/material damage/damage to the appliance!

The use of spare parts and accessories supplied by other brands is dangerous and may result in injury, material damage or damage to the appliance.

For safety reasons, use genuine spare parts and accessories only.

Caution!

Material damage/damage to the appliance

Cleaning agents and agents for pretreating laundry (e.g. stain removers, prewash sprays, etc.) may cause damage if they come into contact with the surfaces of the appliance. Therefore please note:

- Do not allow these agents to come into contact with the surfaces of the appliance.
- Clean the appliance with nothing but water and a soft, damp cloth.
- Remove any detergent, spray or other residues immediately.

Energy-saving tips

- Spin the laundry before drying. The drier the laundry, the shorter the programme will be, in turn reducing energy consumption.
- Load the appliance with the maximum loads permitted for the programmes.

Note: If the maximum load is exceeded, this extends the programme duration and increases energy consumption.

- Operate the appliance in a ventilated room and make sure that the air inlet on the appliance is unobstructed so that air exchange can take place unhindered.
- Regularly remove the fluff from the appliance. If there is fluff in the appliance, this extends the programme duration and increases energy consumption.
- If you do not perform any actions on the appliance for an extended period before the programme starts or once the programme has ended, the appliance will automatically switch to Energy saving mode. The display and indicator lights will go out after a few minutes and  (Start/Pause) will flash. To end Energy saving mode, all you need to do is perform an action on the appliance, such as opening and closing the door.
- If you do not perform any actions on the appliance for an extended period when it is in energy-saving mode, the appliance automatically switches itself off.

Note: If Wi-Fi is activated, the appliance will not switch itself off automatically.

Installing and connecting the appliance

Included with the appliance:

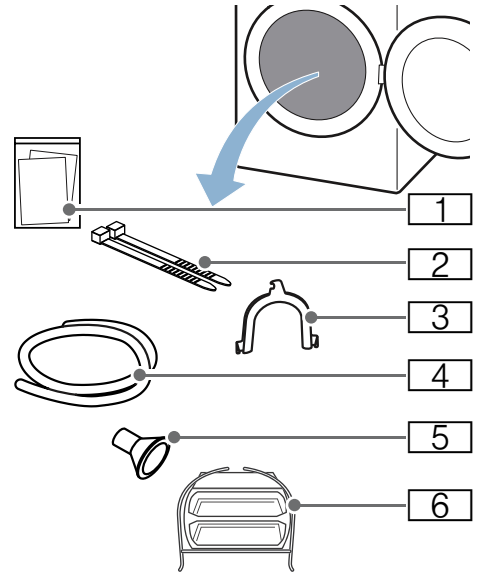

- 1 Accompanying documents (e.g. installation and operating instructions)
- 2 Fastening parts
- 3 U-piece for fixing the drain hose in place
- 4 Drain hose
- 5 Connection adapter
- 6 Basket for woollens

en Installing and connecting the appliance

1. Remove any packaging and protective covers completely from the appliance.
2. Press on the door.

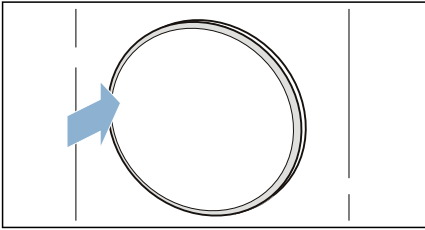

The door lock is released and the door opens.

3. Open the door.
4. Remove all the accessories from the drum.

You can now install and connect the appliance.

Caution! **Risk of material damage/damage to the appliance**

Objects remaining in the drum that are not designed for operation with the appliance may result in material damage and damage to the appliance. Remove these objects, along with all accessories, from the drum.

Installing the appliance

Warning **Risk of death!**

Children may lock themselves inside appliances and find themselves in a life-threatening situation.

- Do not position the appliance behind a door, as this may obstruct the appliance door or prevent it from opening completely.
- Once an appliance has reached the end of its life, pull the mains plug from the socket **before** severing the mains cable, and then destroy the lock on the appliance door.

Warning **Risk of explosions/fire!**

If there is coal dust or flour in the air around the appliance, this may cause an explosion.

Make sure that the area around the appliance is kept clean when it is in operation.

Warning **Risk of fire/material damage/damage to the appliance!**

The appliance contains R290, a refrigerant that is environmentally friendly but flammable.

Keep open fire and ignition sources away from the appliance.



Warning **Risk of injury/material damage/damage to the appliance!**

- The appliance may vibrate or move when in operation, potentially resulting in injury or material damage. Place the appliance on a clean, even, solid surface and, using a spirit level to guide you, level it with the screw-in feet.
- Incorrectly placing (stacking) this appliance on top of a washing machine may result in injury, material damage and/or damage to the appliance. If this appliance is to be placed on top of a washing machine, the washing machine must be of at least the same depth and width as the appliance, and it must be secured in place with the appropriate connection set if available.
→ Page 17
The appliance **MUST** be secured with this connection set. Stacking the appliance in any other way is forbidden.

- If you take hold of any of the appliance's protruding parts (e.g. the appliance door) in order to lift or move it, these parts may break off and cause injury. Do not take hold of any of the appliance's protruding parts in order to move the appliance.

Warning

Risk of injury!

- The appliance is very heavy. Lifting it may result in injury. Do not lift the appliance on your own.
- The appliance has sharp edges on which you could cut your hands. Do not take hold of the appliance by its sharp edges. Wear protective gloves to lift it.

Caution!

Material damage/damage to the appliance

If the appliance overheats, it may not be able to operate properly, or this may result in material damage or damage to the appliance.

Make sure that the appliance's air inlet is never obstructed when the appliance is in operation, and that the area around the appliance is adequately ventilated.

Caution!

Risk of material damage and damage to the appliance

The appliance underwent a function test before leaving the factory and therefore may contain residual water. This residual water may leak out if the appliance is tilted at an angle greater than 40°.

Install the appliance as follows:

1. Place the appliance on a clean, even, solid surface.
2. Check that the appliance is level using a spirit level.

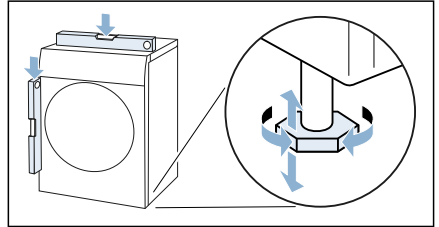

3. If necessary, turn the appliance feet to make sure it is level. You can now connect the appliance.

Notes

- All appliance feet must stand firmly on the ground.
- If appliances are not installed correctly, this may result in noises, vibrations, uneven drum operation and/or to residual water leaking out of the appliance.

Connecting the appliance

Warning

Risk of electric shock/fire/material damage/damage to the appliance!

If the appliance is not installed properly, this may lead to a dangerous situation. Ensure the following:

- The mains voltage on your power socket must match the rated voltage specified on the appliance (identification plate). The connected loads and the required fuse protection are specified on the identification plate.

en Installing and connecting the appliance

- The appliance must not be supplied through an external switching device, such as a timer, or connected to a circuit that is regularly switched on and off by a utility.
- The mains plug and the protective contact socket must match and the earthing system must be correctly installed.
- The installation must have an adequate cross section.
- The mains plug must be freely accessible at all times. If this is not possible, in order to comply with the relevant safety regulations, a switch (all pole disconnection) must be built into the permanent installation in accordance with electrical installation regulations.
- If using a residual current circuit breaker, only use one that bears the following mark: . The presence of this mark is the only way to be sure that it fulfils all the applicable regulations.

Warning

Risk of electric shock/fire/material damage/damage to the appliance!

If the appliance's mains cable is altered or damaged, this may result in electric shock, short circuiting or fire due to overheating.

The mains cable must not be kinked, crushed or altered, and must not come into contact with any heat sources.

Warning

Risk of fire/material damage/damage to the appliance!

The use of extension cords or power strips may result in fire due to overheating or short circuiting. Connect the appliance directly to an earthed socket that has been correctly installed. Do not use extension cords, power strips or multi-way couplers.

Warning **Risk of injury!**

If the hoses and mains cables are not correctly routed, they may constitute a tripping hazard, which may result in injury.

Route hoses and cables such that they do not constitute a tripping hazard.

Connect the appliance as follows:

1. Connecting the drain hose.

→ Page 51

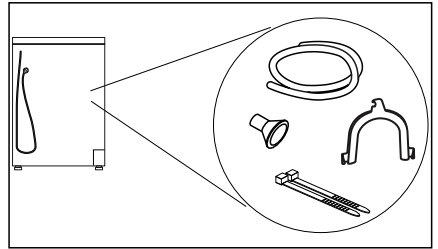

2. Plug the appliance's mains plug into the designated socket.
 3. Check that the mains plug is in securely.
- Your appliance is now ready to use.

Caution!

Risk of material damage/damage to the appliance

The appliance contains refrigerant and may be damaged if it is operated immediately after transportation. Allow the appliance to rest for two hours before initial use.

Note: If in doubt, have your appliance connected by a qualified professional.

Before using the appliance for the first time

Before you switch on the appliance:

Check that there is no visible damage to the appliance. Do not operate the appliance if it is damaged. Should you have any problems, please contact your specialist dealer or our customer service.

Note: Once the appliance has been properly installed and connected, it is ready to use. No further steps are necessary.

Optional accessories







Order optional accessories* from the after-sales service:

- **Basket for woollens:**
Dry or air individual woollen items, sports shoes and soft toys in the basket for woollens.
 - Order number: —.
- **Platform:**
For easier loading and unloading, raise your dryer with a platform. You can transport laundry with the laundry basket integrated into the platform drawer.
 - Order number: **WZ20505**.
- **Washer-dryer stack connection kit:**
To save space, the dryer can be placed on top of a suitable washing machine of the same width and depth. Only this connection kit may be used to secure the dryer to the washing machine.
 - Order number with pull-out worktop: —
 - Order number without pull-out worktop: —.

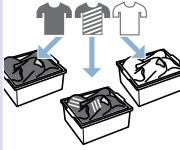
* Depending on the appliance features

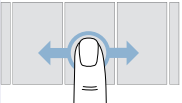
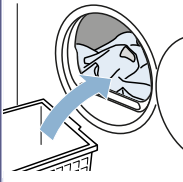
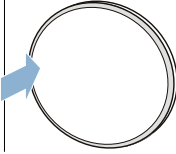
Quick reference guide

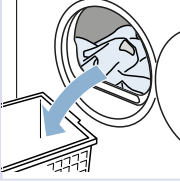
Note: The appliance must be correctly installed and connected. → *Page 13*

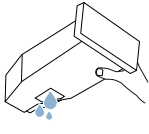
1	Before starting the programme:	⇒ 	⇒ 	⇒ 		
		Sort the laundry.	Switch on the appliance.	Select a programme.		
		2		⇒ 	⇒ 	⇒ 
				Close the door.	If necessary: Adjust the programme settings.	Start the programme.
3	Once the programme has ended:	⇒ 	⇒ 	⇒ 		
		Open the door and remove the laundry.	Put the appliance in standby mode.	Empty the condensation container.		

Familiarising yourself with your appliance

Appliance overview

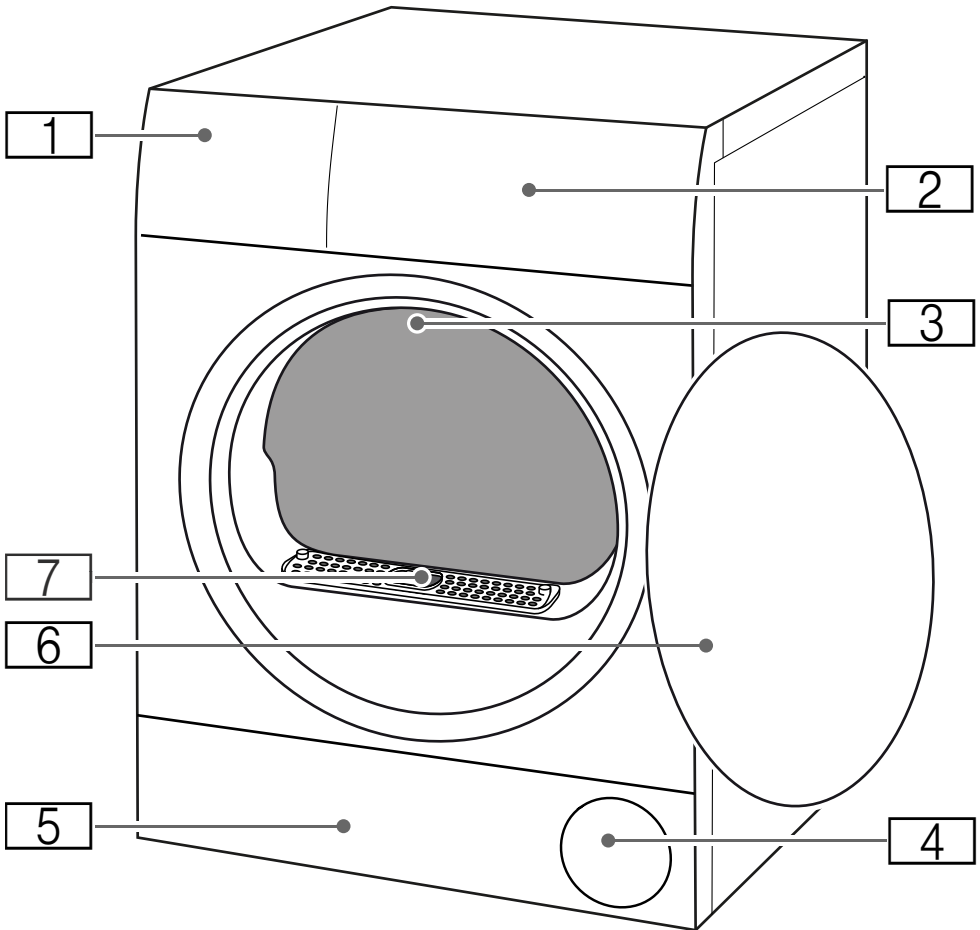

- 1** Condensation container
- 2** Control panel
- 3** Drum interior lighting (depending on the model)
- 4** Air inlet
- 5** Maintenance flap on the base unit
- 6** Door
- 7** Air channel cover

Panel



1 Display

The display on this appliance responds to touch (touch display).

- You operate it by lightly pressing/tapping or swiping/scrolling
- Display settings and information

2 :

Open the door automatically.

You can only open the door automatically if the appliance is switched on and the programme progress allows it.

3 : Switch on the appliance or put it in standby mode.

Display

The display on this appliance responds to touch (touch display). You operate the display by lightly pressing/tapping or swiping/scrolling.

Caution!

Material damage/damage to the appliance.

Exerting excessive pressure on the display may damage it. Do not use a sharp object on the display or exert excessive pressure on it.

Note: If you touch the screen near the edge, the appliance may not detect this if you have touched it outside of the detection area.

Display overview

After switching on the appliance:

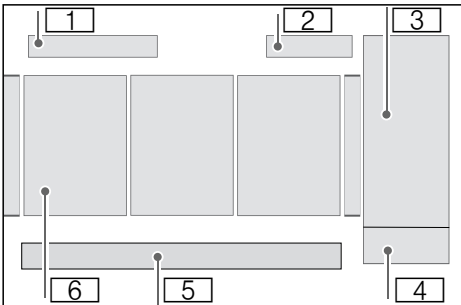

- 1 Programmes or favourites**
- 2 Time** → Page 40
- 3 Additional functions** → Page 31
- 4 Start or Pause**
- 5 Appliance settings** → Page 38
- 6 Programmes** → Page 26

After selecting a programme:

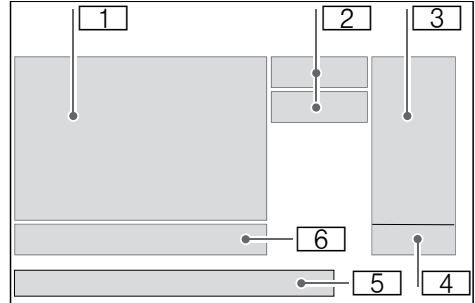

- 1 Programme** → Page 26
- 2 Programme configuration**
→ Page 30
- 3 Additional functions** → Page 31
- 4 Start or Pause**
- 5 Appliance settings** → Page 38
- 6 Programme management**
→ Page 29

Operating logic

Pressing/tapping

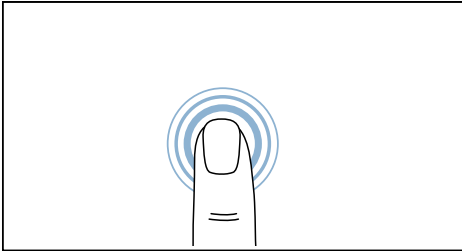

Press your finger on the display to open or set an element.

Swiping/scrolling

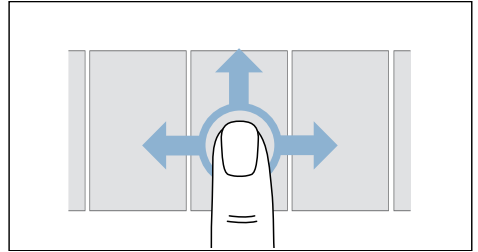

Use your finger to swipe/scroll through the display in order to move the displayed contents horizontally or vertically.

What the symbols mean



Setting deactivated



Setting selected



Return to the higher-level screen

What the colours mean



Setting can be activated or has already been activated





Setting cannot be activated



Setting has been selected

Information in the display

Display	Information
<p>Condenser tray full. Appliance unable to work. Empty the condenser tray.</p>	<ul style="list-style-type: none"> ■ Empty the condensation container and then reinsert it. → <i>Page 37</i> Then press  (Start/Pause). ■ Clean the filter in the condensation container. → <i>Page 55</i> ■ If the optional drain hose* is installed, make sure that the drain hose: <ul style="list-style-type: none"> - Is correctly connected. → <i>Page 51</i> - Is not kinked or bent. - Is not blocked or clogged, e.g. by deposits. ■ Run the intensive appliance care programme. → <i>Page 65</i> ■ Check that no debris has found its way into the base unit. Open the maintenance flap and remove any debris. → <i>Page 57</i>
<p>Lint filter full. Length of drying cycle affected. Remove and empty the lint filter and the lint trap. Then clean both with warm water.</p>	<p>Cleaning the base unit → <i>Page 57</i></p>
<p>Quick Care should be performed. Providing optimal drying results every time. The total duration will be ca. 40min.</p>	<p>After a certain period, the appliance automatically recommends that you run the basic appliance care programme. Run the basic appliance care programme. → <i>Page 63</i></p>
	<ul style="list-style-type: none"> ■ Off: Wi-Fi is switched off and your appliance is not connected to your home network. ■ Flashing: Your appliance is trying to connect to your home network. ■ Continuously lit: Wi-Fi is switched on and your appliance is connected to your home network.
	<p>Lit: appliance is connected to the smart energy system (Energy manager) (not available in every country)</p>
<p>Software update is available. Would you like to install update?</p>	<p>New software version available for the appliance. Run the software update. → <i>Page 46</i></p>
<p>selfCleaning</p>	<p>The appliance's automatic self-cleaning function is running. Do not pull out the condensation container or cancel the program while this is displayed.</p>

**Drum content still hot. Cool down active.
Appliance can be used as usual.**

The appliance can reach high temperatures when drying. To cool the laundry, the CoolDown process reduces the temperature in the drum. If the door is not opened, the CoolDown process automatically starts after 30 seconds in the following cases:

- If the program is paused
- If the program is cancelled
- If the appliance is put into standby mode using the app

You can continue to operate the appliance during the CoolDown process.

Notes

- The drum continues to rotate during the CoolDown process, even if you have paused the program.
- Temperature regulation can take up to 10 minutes.

* Depending on how the appliance is equipped or the available accessory

Overview of programmes

Programme	Maximum load
<p>Programme name Brief explanation of the programme and the items for which it is suitable.</p>	<p>Maximum load based on the dry weight of the items</p>
<p>Cotton Hard-wearing items and heat-resistant items made of cotton or linen.</p>	<p>9 kg</p>
<p>Easy-Care Items made of synthetic or blended fabrics.</p>	<p>3.5 kg</p>
<p>Mixed Fabrics Mixed load consisting of items made from cotton and synthetic fabrics.</p>	<p>3 kg</p>
<p>Lingerie Delicate, washable underwear, e.g. made from lace, Lycra, satin or blended fabrics.</p>	<p>1 kg</p>
<p>Wool Finish Machine-washable items made of wool or containing wool.</p> <p>Notes</p> <ul style="list-style-type: none"> ■ Laundry becomes fluffier but not dry. ■ Remove laundry once the programme has ended and allow to dry. 	<p>0.5 kg</p>
<p>Wool in Basket Items made from wool or containing wool.</p> <p>Note: Dry the laundry only using the basket for woollens → <i>Page 48.</i></p>	<p>1 basket load</p>
<p>myTime Timed programme for all types of fabric except for wool and silk. Suitable for pre-dried or slightly damp laundry and for drying off multi-layered, thick laundry.</p> <p>Note: In the timed programme, the laundry's remaining moisture is not automatically detected. If the laundry is still too damp when the drying programme has ended, repeat the programme and, if required, extend the programme duration. → <i>"Programme settings" on page 28</i></p>	<p>3 kg</p>
<p>Airing Timed programme for all types of fabric except for wool and silk. For freshening up or airing clothing that has hardly been worn.</p> <p>Note: You can adjust the programme duration. → <i>"Programme settings" on page 28</i></p>	<p>3 kg</p>
<p>Rapid 40 min Mixed load of synthetic fabrics and light cottons.</p>	<p>2 kg</p>

<p>Jeans</p> <p>Jeans and thick, double-layered items made from cotton.</p> <p>Note: Turn laundry inside out before drying.</p>	6 kg
<p>Towels</p> <p>Hard-wearing towels and dressing gowns made of cotton.</p>	6 kg
<p>Duvet</p> <p>Clothing, pillows, quilts or bedspreads filled with synthetic fibres.</p> <p>Note: Dry large items individually. Follow the instructions on the care label.</p>	2.5 kg
<p>Pillows</p> <p>Pillows stuffed with down or synthetic fibres.</p> <p>Note: Once the programme has ended, shake down-stuffed pillows to distribute the stuffing and eliminate any pockets of moisture. Restart the programme if necessary.</p>	1 pillow
<p>Outdoor</p> <p>Weatherproof and outdoor clothing with a membrane coating and water-repellent fabrics.</p>	1 item
<p>Shirts</p> <p>Shirts/blouses made of cotton, linen, or synthetic or blended fabrics.</p> <p>Note: Once the laundry is dry, iron it or hang it up. This will allow the residual moisture to be distributed evenly.</p>	1.5 kg
<p>Delicates</p> <p>Delicate, washable items, e.g. made from satin, or synthetic or blended fabrics.</p>	2 kg
<p>Shoes in Basket</p> <p>Shoes/sports and leisure shoes.</p> <p>Notes</p> <ul style="list-style-type: none"> ■ Dry the laundry only using the basket for woollens → <i>Page 48</i>. ■ Do not dry leather shoes or shoes with leather parts. 	1 pair

P+ Programme settings

Once you have set a programme, you are shown the available programme settings.

You can activate/deactivate or adjust the programme settings.

Notes

- Not all programme settings are available for every programme.
- Your changes are not saved permanently for the programme.
- Press ← to return to the higher-level screen.
- Press X in order to close the current view.

Activate/deactivate the programme setting as follows:

Press the setting.

The setting is activated if it is selected. The setting is deactivated if it is not selected.

Note: Your changes are implemented without further confirmation.

Adjust the programme setting as follows:

1. Press the setting.
The setting options are displayed.
2. Press and hold the sliding bar and swipe left/right.

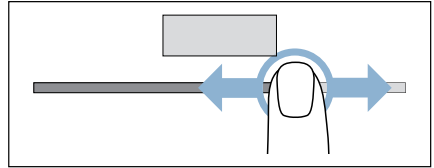

The set value is displayed.

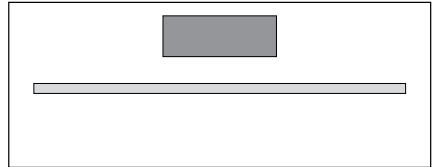

Note: Your changes are implemented without further confirmation.

Programme management

After you have set a programme, various programme management functions are available to you.



Start delay

Before the programme starts, you can set when the programme should be ready.

1. Press (Ready in).
2. Adjust the programme setting until the required time until the end of the programme is displayed.

Note: Once you have set the time on your appliance, you can set the programme time using the time. If you have not set the time, you can set the programme end in hours and 30 minute increments.

3. Press (Start/Pause).

The programme end is now set and your programme starts after a delay.

Note: If required, you can still add or remove laundry. → *Page 36*

Flex start

Activate the **Flex start** function to allow your smart energy system (Energy manager) to start your appliance once your home photovoltaic system is able to provide sufficient energy or the energy tariff is good.

Note: Your smart energy system (Energy manager) cannot start your appliance until it is connected to the appliance.

Adjust the programme setting as follows:

1. Press (Ready in).
2. Adjust the programme setting until the required time until the end of the programme is displayed.

Note: Once you have set the time on your appliance, you can set the programme time using the time. If you have not set the time, you can set the programme end in hours and 30 minute increments.

3. Press (Start/Pause).
4. Press **Flex start** in the display message that follows.
5. Press .

appears in the display.

The **FlexStart** function has now been activated and the appliance will wait to be remotely started by the smart energy system (Energy manager).

1. Press (Start/Pause).
2. Open the door.
3. Add or remove laundry.
4. Close the door.
5. Press (Start/Pause).
6. Press .

The **FlexStart** function has now been activated and the appliance will wait to be remotely started by the smart energy system (Energy manager).

Note: For safety reasons, the remote start is deactivated in the following cases:

- Opening the door
- Pausing the programme
- Pressing (Remote Start) again
- Pressing
- Power failure

Note: If the smart energy system (Energy manager) does not start your appliance or remote start has been deactivated, the programme is nonetheless started before the set time period starts and ends when the time period expires.

Programme information

You can display useful information for each programme.

Press  .

Favourite programme

You can save a programme or a programme with adjusted settings as a favourite.

Save the favourite programme as follows:

1. Set and, if required, adjust the required programme.
2. Press ☆ .
The programme is now saved as a favourite.

Notes

- You can save up to seven favourite programmes.
- Each programme can only be saved once.

Call up the favourite programme as follows::

1. Press ☆ **Favourites** .
The saved favourite programmes are displayed.
2. Press the required favourite programme.
3. Press  (Start/Pause) to start the programme.

Delete the favourite programme as follows:

1. Call up the favourite programme.
2. Press ☆ .
3. Confirm the message in the display.
Your favourite programme has now been deleted.

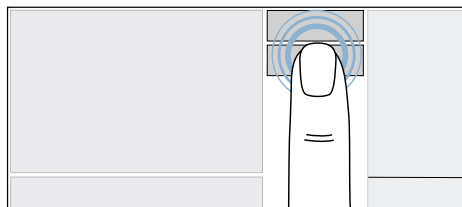

Programme configuration

After you have set a programme, you can adjust the programme configuration, if required.



Dryness level

The dryness level defines how damp or dry the laundry is after the programme ends.

Drying targets	Laundry
 (Cupboard Dry Plus)	Very dry. Multi-layered, thick laundry that does not dry readily.
 (Cupboard Dry)	Dry. Normal, single-layered laundry.
 (Iron Dry)	Slightly damp. Normal, single-layered laundry that still needs to be damp after drying and is suitable for ironing or hanging up.

Note: The drying result always depends on the type of laundry that you are drying. Trousers with a thick waistband or multi-layered thick fabrics do not dry as easily as thin, lightweight fabrics. To ensure an even drying result, you should therefore sort the laundry.

Adjust the programme setting as follows:

1. Press  (Dryness level).
2. Press the required dryness level.
3. If required, press +/- (Fine adjustment) and adjust the degree of dryness.

Note: If your washing is still damp after drying, even though you have reached the dryness level, you should adjust the degree of dryness. This increases the drying time for the dryness level and your laundry is dryer.

The dryness level has now been set.

Notes

- Your changes also remain saved when the appliance is in standby mode.
- If you adjust the degree of dryness for a dryness level, this change will be applied to all programs and favourite programs that use this dryness level.

Drying time

You can adjust the drying time for **time programmes**.

1. Press .
2. Set the required time.
The drying time is now set.

Low-heat drying

You can reduce the drying temperature for delicate textiles, such as polyacrylic or elastane.

Note: This may increase the drying time.

1. Press .
2. Activate or deactivate the setting.

Additional functions

After you have set a programme, additional functions are available to you.

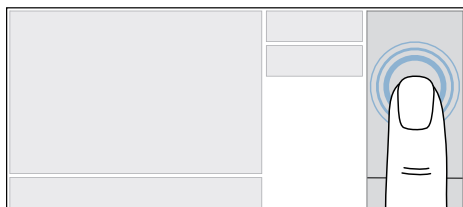



Remote start

You can enable the appliance for remote start via the Home Connect app.

1. Connect the appliance to the home network and the Home Connect app.
→ *Page 42*
2. Ensure that the door is closed.
3. Ensure that the childproof lock is deactivated.
4. Press .

You can now remotely start the appliance via the Home Connect app.

Note: For safety reasons, the remote start is deactivated in the following cases:

- Opening the door
- Pausing the programme
- Pressing  (Remote Start) again
- Pressing 
- Power failure

Anti-Crease

You can set additional anti-crease for your laundry. In doing so, the drum moves the laundry in the drum at regular intervals after drying to prevent creasing.

1. Press .
2. Set the required time.



Laundry

Preparing the laundry



Warning

Risk of explosions/fire!

Certain objects may ignite when drying is in progress, or even cause the appliance to catch fire or explode. Remove any lighters or matches from pockets on items of clothing.

Caution!

Risk of damage to the drum and laundry

Leaving objects in the pockets of your clothing can cause damage to the drum and laundry when the appliance is in operation. Remove all objects (e.g. metal items) from clothing pockets.

Prepare the laundry as follows:

- Tie cloth belts, apron strings, etc. together or use a laundry bag.
- Close zips, hooks, eyelets and buttons. Button up large items of laundry, such as covers.
- Always dry very small items of laundry, e.g. babies' socks, together with large items such as towels.
- Use timed programmes for single items.
- Knitted items, such as T-shirts and jerseys, often shrink slightly the first time they are tumble-dried. Use a gentle programme.

- Do not overdry easy-care laundry. This leads to increased creasing of your laundry.
- Some detergents and care products, e.g. starch or softeners, contain particles that may accumulate on the moisture sensor. This may impair the sensor's performance and, in turn, the drying result.

Notes

- When washing laundry to be tumble-dried, use the correct amount of detergent and care products as specified in the manufacturer's instructions.
- Clean the moisture sensor regularly → *Page 55*.

Sorting laundry

Note: Load the laundry item by item into the appliance. For more effective drying, do not stuff an entire bundle of laundry into the dryer at once.

Caution!

Risk of material damage to the dryer or laundry

Laundry that is unsuitable for tumble-drying may damage the appliance and the laundry when it is dried. Before you dry it, sort the laundry according to the information given on the care label:

- Suitable for tumble drying
- Dry at normal temperature
- Dry at low temperature
- Do not tumble-dry

When sorting the laundry to be dried, take the following points into account:

- To achieve an even drying result, only dry laundry of the same type of fabric and texture together. If you dry thin, thick and multi-layered fabrics together, they will dry to differing degrees.
- Use the fabric descriptions given for the individual drying programmes to help you choose the most appropriate programme.
→ "Overview of programmes" on page 26
→ "Drying with the basket for woollens" on page 48

Note: You can select a timed programme to add extra drying time for laundry that is still damp.

Caution!

Risk of material damage to the appliance and laundry

Do **not** tumble-dry the following items or fabrics in the appliance:

- Laundry contaminated with solvents, wax or grease.
- Unwashed items.
- Items made from non-breathable fabrics (e.g. rubber-coated).
- Items made from delicate fabrics, such as silk and curtains made of synthetic material.



Operating the appliance

Switching on the appliance

Note: The appliance must be correctly installed and connected. → Page 13

Press  to switch on the appliance.

Notes

- It may take a few seconds for the appliance to switch on or restart.
- When you switch on the appliance for the first time or reset to factory settings, you must set the required language.

Opening the door

You can open the appliance door **automatically**.

Note: You can open the appliance door automatically only when the appliance is switched on.

Open the door automatically as follows:

1. Press  to open the door.

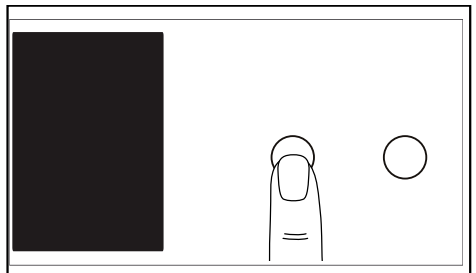

The door lock is released and the door opens.

en Operating the appliance

2. Open the door.

If the power supply to the appliance is interrupted (e.g. power failure), you must open the appliance door **manually**.

Manually open the door as follows:

1. Press on the door.

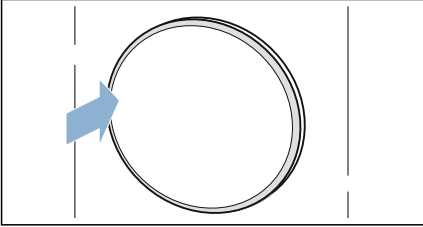

The door lock is released and the door opens.

2. Open the door.

Placing the laundry into the drum

1. Prepare and sort the laundry.
2. Check that the drum is completely empty. If required, empty the drum.
3. Load the laundry unfolded into the drum.

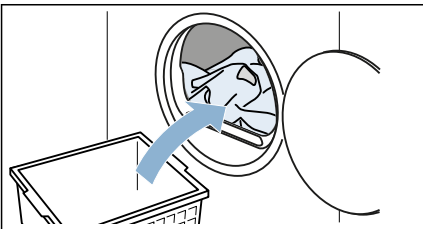

Closing the door

Close the door.

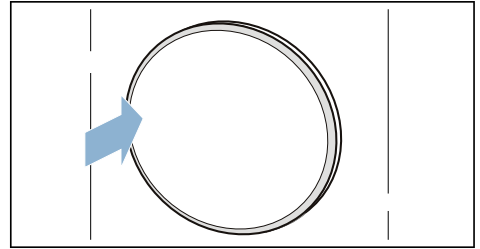

Caution!
Risk of material damage to the appliance or laundry.

Make sure that laundry is not trapped in the door.



Setting a programme

Notes

- If you have activated the childproof lock, you must deactivate it before you can set a programme.
→ *Page 38*
 - Under ☆, you can call up programmes that you have saved as favourites and set the required programme.
1. Scroll through until the required programme is displayed.
→ *"Overview of programmes" on page 26*

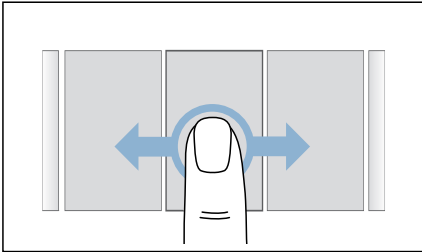

2. Press the programme.

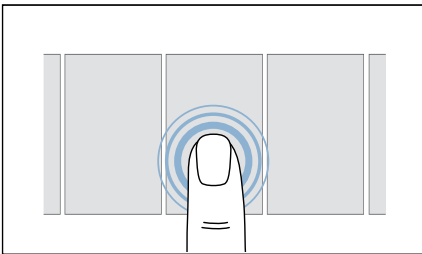

Your programme is now set and the corresponding **programme settings** are displayed.

3. Adjust the **programme settings** if required.

Starting a programme

Press ▶|| (Start/Pause).

Note: If you want to prevent the programme from being adjusted inadvertently, you can activate the childproof lock. → *Page 38*

Programme progress

The programme status will be indicated on the display.

Note: When a programme is selected, the expected drying time for the maximum permitted load is displayed. The moisture sensor measures the residual moisture in the laundry as it is being dried. The programme duration and the remaining time indicated on the display are automatically adjusted as the programme progresses, depending on how damp the laundry is (exception: Timed programmes).

Adding more laundry or removing laundry

After the programme starts, the start delay or appliance is enabled for remote start, you can add or remove laundry as necessary.

1. Press ▷||| (Start/Pause).
2. Press ≡ to open the door.
3. Add or remove laundry.
4. Close the door.
5. Press ▷||| (Start/Pause).
6. Press □ (Remote Start) if you want to enable the appliance for remote start.

Note: If you pause the programme when the door is closed, the laundry cannot cool down. For safety reasons, the CoolDown process is started after 30 seconds.

In doing so, the drum turns, the laundry is cooled and the following message appears in the display: **Drum content still hot. Cool down active. Appliance can be used as usual.**

You can interrupt the CoolDown process by opening the door or continuing the programme.

Note: The programme duration is updated on the display, depending on the load and on the residual moisture in the laundry. The values displayed may change when the programme or load is changed.

Cancelling the programme

1. Press ▷||| (Start/Pause).
2. Press **Cancel**.
3. Press ≡ to open the door.
4. Remove the laundry.

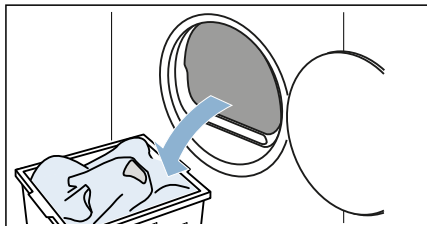

Caution!

Risk of fire. Laundry may catch fire.

If you cancel the programme, remove all items of laundry from the dryer and spread them out to allow the heat to dissipate.

Programme end

The following message appears in the display: **Laundry is ready.**

Removing laundry and switching off the appliance

1. Press ≡ to open the door.
2. Remove the laundry.

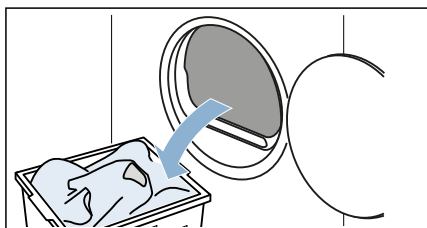

3. Press ⏻ for standby mode.

Emptying the condensation container

Note: If the message **Condenser tray full. Appliance unable to work. Empty the condenser tray.** appears in the display, confirm the message in the display.

Condensation will form in the appliance as it dries the laundry.

If there is no drain hose connected to the appliance, the condensation water from the appliance will run into the condensation container. In this case, you will need to empty the condensation container each time the dryer finishes drying the laundry, and also if it becomes full before drying is complete.

1. Pull out the condensation container horizontally.

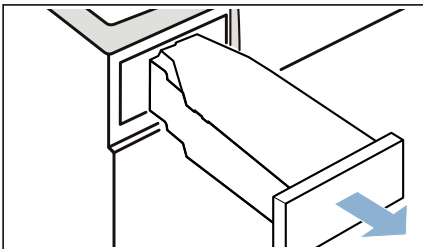

2. Pour out the condensation water.

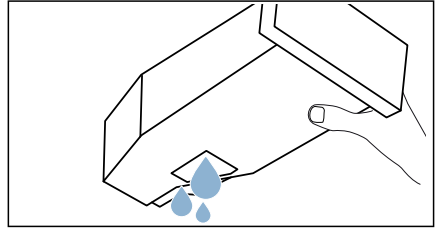

Caution!

Risk of harm to health and material damage

Condensation water is not suitable for drinking and may be contaminated with fluff.

Contaminated condensation water may be harmful to your health and cause material damage. Do not drink the condensation water or reuse it.

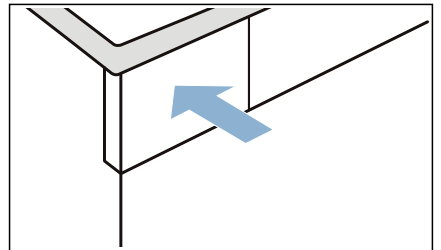

3. Push the condensation container back into the appliance until you feel it lock into place.



Note: The filter in the condensation container filters the condensation water, which is used during the appliance's automatic cleaning cycle. The filter is cleaned by emptying out the condensation water. You should still check the filter regularly for any build-up, and remove this if necessary.
 → "Cleaning the filter in the condensation container" on page 55

Appliance settings

You can activate/deactivate the following appliance settings directly or change further appliance settings under .

1. Switch on the appliance.
2. Press  or press and hold  and swipe upwards.

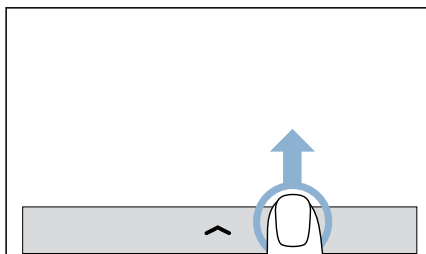

A menu is displayed.

Childproof lock

You can activate or deactivate the appliance's childproof lock. You can activate the childproof lock to prevent the control panel from accidentally being operated.

Activate the appliance setting as follows:

Press .

The childproof lock is activated.

Notes

- You can activate the childproof lock at any time after you switch on the appliance.
- The childproof lock also remains activated when the appliance is in standby mode. In order to be able to operate the control panel after the appliance is switched on, you must deactivate the childproof lock.

Deactivate the appliance setting as follows:

1. Press anywhere on the display.
A message appears in the display.
2. Press and hold **Deactivate child lock** for three seconds.
The childproof lock is deactivated.

Tones

You can activate or deactivate the appliance's signal tones. If you deactivate the signal tones, operate the appliance without operating and information signals.

Activate/deactivate the appliance setting as follows:

Press .

The signal tones are activated/deactivated.

Other appliance settings

You can activate/deactivate or adjust further appliance settings under .

1. Press .
2. Swipe until the require setting appears.

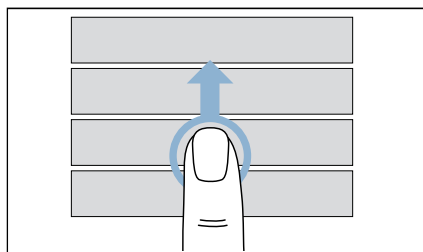

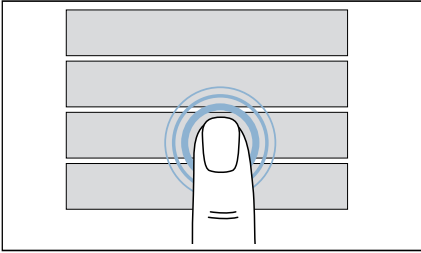
3. Press the setting.

You can now activate/deactivate or adjust the appliance setting.

Notes

- Your changes also remain saved when the appliance is in standby mode.
- Press ← to return to the higher-level screen.
- Press ✕ in order to close the current view.

Activate/deactivate the appliance setting as follows:

Press the setting.

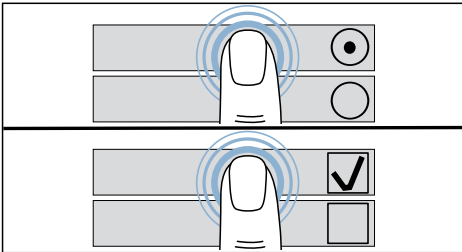

The setting is activated if it is selected.
The setting is deactivated if it is not selected.

Note: Your changes are implemented without further confirmation.

Adjust the appliance setting as follows:

Press the sliding bar **or** press and hold the sliding bar and swipe left/right.

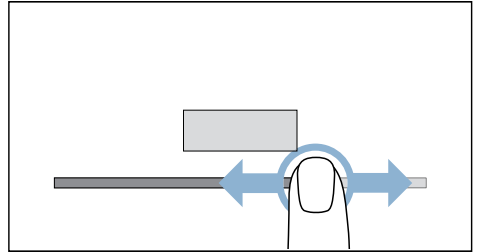

The set value is displayed.

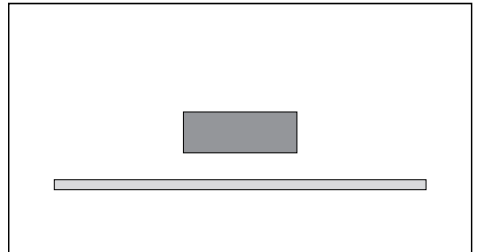

Note: Your changes are implemented without further confirmation.

Time

You can activate/deactivate and adjust the time on the appliance.

1. Press **Time**.
2. Press **On**.
3. Press the display for the hours and minutes in order to adjust the hours/minutes.

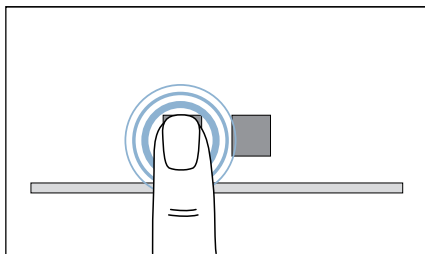

4. Adjust the appliance setting.
The time is activated and set on the appliance.

Note: The time is only shown in the display if it is activated and set. → *Page 72*

Tones

You can adjust the volume of the signal tones at the end of the programme as well as the operating and information signals.

1. Press **Sounds**.
2. Press **Programme End** or **Buttons and Info**.
3. Adjust the appliance setting.
The volume of the signal tones at the end of the programme and/or operating/information signals is set.

Brightness

You can adjust the display brightness.

1. Press **Brightness**.
2. Adjust the appliance setting.
The display brightness is set.

Home Connect

You can use the appliance setting **Home Connect** to control your household appliances using mobile end devices.

Further information: → *Page 42*

Software update

You can use the appliance setting **Software Update** to update the appliance's Home Connect software if a new version is available.

Further information: → *Page 46*

Languages

You can change the language of the appliance. When you activate the new language for the appliance, the previous language is automatically deactivated.

1. Press **Language**.
2. Activate/deactivate the setting.
3. Press **Restart**.
The language for the appliance is set.

Notes

- Your changes are only implemented once you restart the appliance.
- It may take a few seconds for the appliance to switch on or restart.
- When you switch on the appliance for the first time or reset to factory settings, you must set the required language.

Light ring

You can adjust the brightness and behaviour of the door light ring.

1. Press **Light Ring** .
2. Press **Set Brightness** or **Set Mode** .
3. Adjust the appliance setting.

The brightness and/or behaviour of the light ring is set.

Note: If you activate this function, the energy consumption increases in comparison to the values specified in the consumption value table.

→ *Page 72*

Spin speed

If you have spun the laundry before drying it, you can set this spin speed on the appliance. The drying time is increased or decreased in accordance with the set spin speed.

Note: The set spin speed does not change the drying time for the time programme.

1. Press **Spin speed** .
 2. Adjust the appliance setting.
- The spin speed at which the laundry was spun before drying is set.

Basic appliance care programme

You can use the appliance setting **Quick Care** to call up and run the basic appliance care programme. As a result, you can achieve long-term optimal drying results.

Further information: → *Page 61*

Intensive appliance care programme

You can use the appliance setting **Indepth Care** to call up and run the intensive appliance care programme. This prevents any unpleasant odours from building up in the appliance after a long period of downtime.

Further information: → *Page 61*

Factory settings

You can reset the appliance to the factory settings. In doing so, all individual settings are reset and the saved favourite programme is deleted.

1. Press **Factory settings** .
2. Press **Reset** .

The appliance is restarted and reset to factory settings.

Note: It may take a few seconds for the appliance to switch on or restart.

Home Connect

This appliance is Wi-Fi-capable and can be remotely controlled using a mobile device.

You can use the Home Connect app to do the following on your appliance from your mobile device:

- Set up programs and launch them.
- Adjust, activate and deactivate program settings.
- Query the status of programs.
- Adjust, activate and deactivate appliance settings.
- Put the appliance into standby mode.

Before you can use the Home Connect functions, you will need to carry out the following steps:

1. Install the Home Connect app on your mobile device.
2. Register in the Home Connect app.
3. Connect your appliance to your home network automatically **or** manually (you only need to do this the first time).
4. Connect your appliance to the Home Connect app.

You can find information about the app on our Home Connect website www.home-connect.com.



Home Connect services are not available in every country. The availability of the Home Connect function depends on the availability of Home Connect services in your country. You can find information on this at www.home-connect.com.

Notes

- Please observe the safety precautions in this instruction manual and make sure that these are complied with even when operating the appliance via the Home Connect app while you are away from home. You must also follow the instructions in the Home Connect app.
- You cannot use the Home Connect app to make changes while the controls on the appliance are being operated. However, you can use the Home Connect app to see any adjustments made directly on the appliance itself.

Calling up the Home Connect menu

In the Home Connect menu, you can create and view network connections, reset network settings, activate/deactivate Wi-Fi and find other Home Connect functions.

1. Switch on the appliance.
2. Press  or press and hold  and swipe upwards.

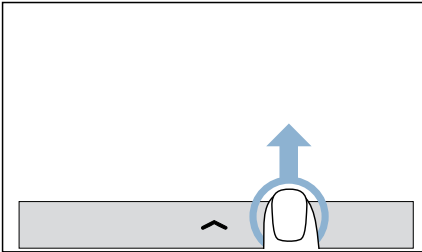

A menu is displayed.

3. Press .
4. Press **Home Connect**.
5. Press **Continue**.

You are now in the Home Connect menu.

Note: Press  to return to the higher-level screen.

Connecting to the home network and the Home Connect app

Connect your appliance to the home network **automatically** or **manually** (you only need to do this the first time).

Notes

- If your home network router has a WPS function, you can connect the appliance to your home network automatically.
- If your home network router does not have a WPS function, you need to connect the appliance to your home network manually.

You must then connect to the Home Connect app.

Note: To connect your appliance to the home network, **Wi-Fi** must be activated on the appliance. **Wi-Fi** is deactivated on the appliance by default and is activated automatically when you connect your appliance to your home network.

Connecting to your home network automatically

Step 2.1

Ensure that you are in the Home Connect menu. → Page 43

1. Press **Settings**.
2. Press **Connect to network**.
3. Press **Connect automatically (WPS)**.
4. Confirm the message in the display. The appliance now attempts to connect to your home network.  flashes in the display.

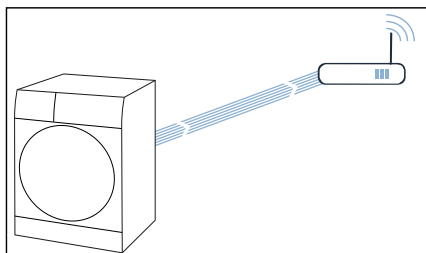

5. Activate the WPS function on your home network router within the next 2 minutes.
6. Confirm the message in the display. If the appliance has connected to your home network successfully, **Your home appliance is connected to your home network.** and  appear in the display and light up continuously.

Note: If you are not able to establish a connection, check whether your appliance is within range of your home network. Try connecting automatically again or connect your appliance manually.

Connecting to your home network manually

Step 2.2

Ensure that you are in the Home Connect menu. → Page 43

1. Press **Settings**.
2. Press **Connect to network**.
3. Press **Connect manually**.

The appliance now sets up its own Wi-Fi network with the name (SSID) **HomeConnect**.

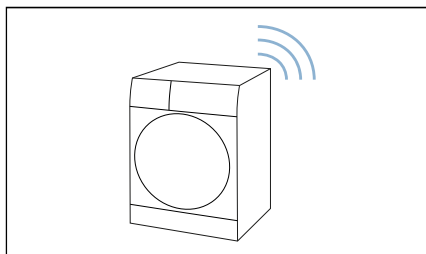

4. Call up the Wi-Fi setting on the mobile device.
5. Connect the mobile device to the **Home Connect** Wi-Fi network and enter the password (key) **HomeConnect**. Your mobile device now connects to the appliance. The connection process may take up to 60 seconds.

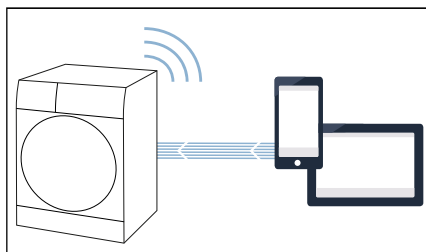

6. Confirm the message in the display.
7. Once you have connected successfully, open the Home Connect app on the mobile device.

8. In the Home Connect app, enter the network name (SSID) and password (key) for **your home network**.
9. Carry out the last steps in the Home Connect app to connect your appliance.
10. Confirm the message in the display. If the appliance has connected to your home network successfully, **Your home appliance is connected to your home network.** and  appear in the display and light up continuously.

Note: If you are not able to establish a connection, check whether your appliance is within range of your home network. Try connecting manually again.

Connecting to the Home Connect app

Step 3

If your appliance is connected to your home network, you can connect it to the Home Connect app.

Ensure that you are in the Home Connect menu. → *Page 43*

Make sure that you have opened the Home Connect app and are logged in.

1. Press **Settings**.
2. Press **Connect with app**.
The appliance now attempts to connect to the Home Connect app.
3. Once your appliance is displayed in the app, carry out the last steps in the Home Connect app.
4. Confirm the message in the display.

Note: If you were not able to establish a connection, check whether your mobile end device is within range of your home network or is connected to this. Try connecting to the Home Connect app again.

Energy management

You can connect your appliance to your smart energy system (Energy manager).

Once you have connected your appliance to the smart energy system (Energy manager) and activated the **Flex start** function, you will be able to optimise your energy consumption because your appliance will not start up until your home photovoltaic system can provide sufficient energy or the energy tariff is good.

Further information and system requirements for using the Energy manager can be found at: **www.home-connect.com/energymanagement**

Notes

- The smart energy system (Energy manager) must use the EEBus initiative communications standard.
- Before you start, read the smart energy system instruction manual to find out how to connect your appliance to the smart energy system (Energy manager).

1. Press .
2. Press **Connect with energy manager**.
Your appliance now attempts to connect to the smart energy system (energy manager). If the appliance has connected successfully, **Your home appliance is connected to your energy manager.** appears in the display.
3. Press **Continue**.
4. Activate Flexstart if you want the smart energy system (Energy manager) to start up your appliance.

Status

View the status of your connection to the home network, to the app and to the energy manager (depending on the appliance features).

Ensure that you are in the Home Connect menu. → *Page 43*

Press **Status**.

Activating/deactivating Wi-Fi

If your appliance is already connected to your home network, you can activate or deactivate **Wi-Fi** on your appliance.

Ensure that you are in the Home Connect menu. → *Page 43*

Press **Wi-Fi**.

Notes

- If you connect to your home network, Wi-Fi is activated automatically.
- If Wi-Fi is activated on your appliance, the appliance is not automatically put in standby mode.
- If Wi-Fi is switched off on the appliance, it is not possible to use the Home Connect app to start or control the appliance remotely.
- If Wi-Fi is switched off and your appliance was previously connected to your home network, this connection will be re-established automatically when Wi-Fi is switched back on.
- If you activate this function, the energy consumption increases in comparison to the values specified in the consumption value table.
→ *Page 72*

Resetting your network settings

You can reset all of the network settings.

Ensure that you are in the Home Connect menu. → *Page 43*

1. Press **Reset**.
Do you want to reset all network settings? appears in the display.
2. Press **Reset**.

Note: If you want to operate your appliance via the Home Connect app again, you will need to reconnect it to your home network and to the Home Connect app.

Updating the software

You can update the Home Connect software on your appliance. As soon as a new software update is available, a note appears in the display: **Software update is available. Would you like to install update?**

Install the update directly via the **message in the display** or **manually** as follows:

1. Press .
2. Press **Software Update**.
The Home Connect software will now be updated.
3. Confirm the message in the display.

Note: If no software update is available, **Your software is up to date**. appears in the display.

Note: The software update may take several minutes. Do not switch the appliance off while updates are being installed.

Information on data protection

When your appliance is connected for the first time to a Wi-Fi network, which is connected to the Internet, your appliance transmits the following categories of data to the Home Connect server (initial registration):

- Unique appliance identification (consisting of appliance codes as well as the MAC address of the installed Wi-Fi communication module).
- Security certificate of the Wi-Fi communication module (to ensure a secure data connection).
- The current software and hardware version of your household appliance.
- Status of any previous resetting to factory settings.

This initial registration prepares the Home Connect functions for use and is only required when you want to use these Home Connect functions for the first time.

Note: Ensure that the Home Connect functions can be used only in conjunction with the Home Connect app. Information on data protection can be accessed in the Home Connect app.

Declaration of Conformity

BSH Hausgeräte GmbH hereby declares that the appliance with Home Connect functionality meets the basic requirements and other relevant provisions of the Directive 2014/53/EU.

A detailed RED Declaration of Conformity can be found online at www.siemens-home.bsh-group.com among the additional documents on the product page for your appliance.



2.4 GHz band: max. 100 mW



Drying with the basket for woollens

The basket for woollens

Note: The basket for woollens is supplied with your appliance* or it can be purchased as an accessory from our after-sales service.

Caution!

Risk of material damage to the appliance and laundry

Operating the dryer when the basket for woollens is damaged may damage the appliance and the laundry.

Never operate the appliance if the basket for woollens is damaged.

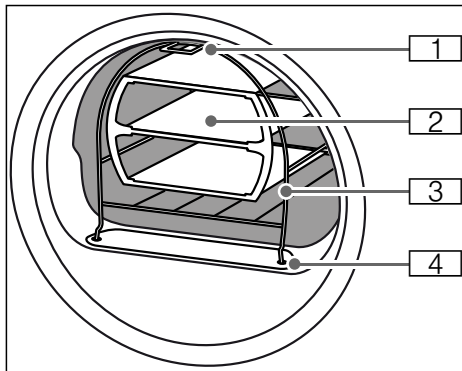

- 1 Foot for securing to the hook in the upper section of the front panel on the appliance
- 2 Insert for the basket for woollens
- 3 Basket for woollens
- 4 Feet for securing in the fluff filter

Securing the basket for woollens

1. Insert the feet of the basket for woollens into the holes in the fluff filter.

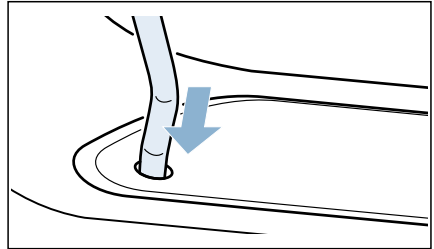

2. Rest the basket for woollens on the upper hooks starting at the front.

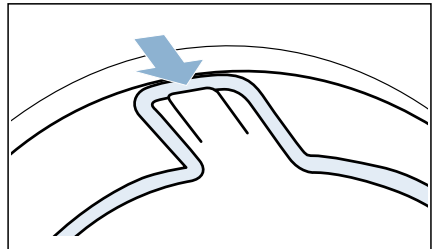

The basket for woollens should now be securely fixed to the front panel.

* Depending on the model

Application examples

■ Laundry

Laundry must be spun.
Place laundry loosely in the insert;
do not squash.
– Trousers or skirt

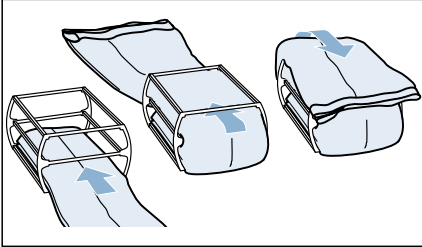

– Pullover

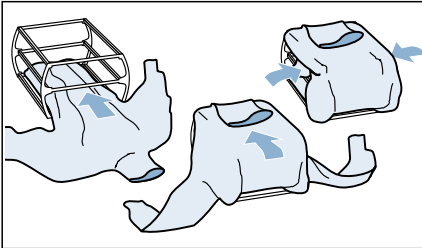

■ Sports shoes

Place sports shoes in the basket for woollens **without** the insert. Pull the tongue quite far out of the shoes. Remove insoles and heel cushions. Roll up a towel and place it under the sports shoes to create an inclined surface. Place the shoes so that the heels are on the towel.

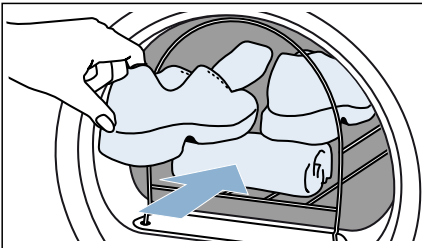

■ Soft toys

Dry soft toys in the basket for woollens without the insert. Only place as many soft toys in the basket for woollens as is possible without any falling out.

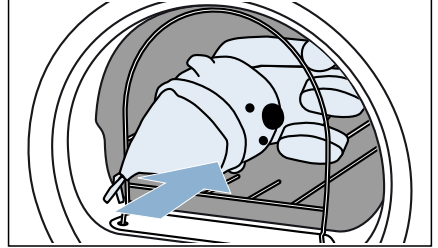

Putting the insert in place and starting a programme

1. Place the insert with laundry, sports shoes or soft toys in the basket for woollens.

Caution!

Risk of material damage to the laundry

Place the laundry in the insert of the basket for woollens so that they do not come into contact with the drum.

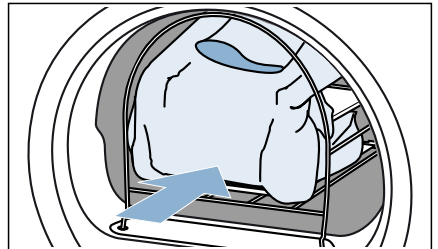

en Drying with the basket for woollens

2. Select the programme for the basket for woollens or a timed programme.
→ *"Overview of programmes"* on page 26
3. Set the drying time.
The table below lists examples for the loads with a suggested drying time.

Thin woollen pullover	Approx. 1 h 20
Thick woollen pullover	Approx. 1 h 30 - 3 h 00
Skirt	Approx. 1 h 00 - 1 h 30
Trousers	Approx. 1 h 00 - 1 h 30
Gloves	Approx. 30 min
Sports shoes	Approx. 1 h 30/ max. 2 h 00 with airing

Note: For items made from thicker or multi-layered fabrics, you may need to extend the drying time to achieve the required dryness level.

4. Start the programme.
5. Once the programme has ended, remove the load and switch off the appliance.

Draining the condensation water

Condensation will form in the appliance as it dries the laundry.

You must ensure that the drain hose is connected when you operate the appliance.

If there is no drain hose connected to the appliance, the condensation water from the appliance will run into the condensation container. In this case, you will need to empty the condensation container each time the dryer finishes drying the laundry, and also if it becomes full before drying is complete.

Connect the drain hose as follows:

1. Remove any accessories from the drum.

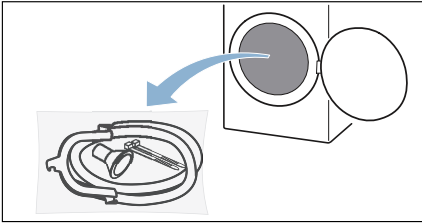

2. Remove all items from the bag.

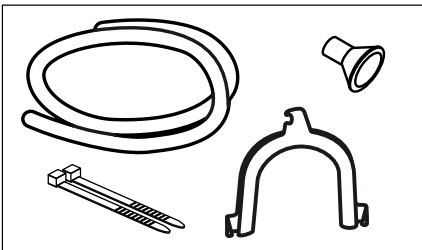

3. Detach the condensation hose from the socket.

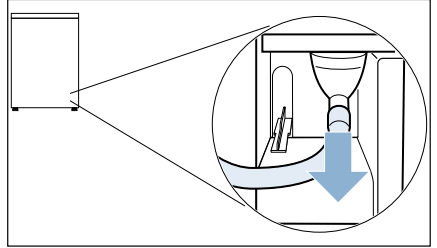

Note: The appliance comes delivered with the condensation hose already fitted to the socket.

4. Place the condensation hose in the "parked" position.

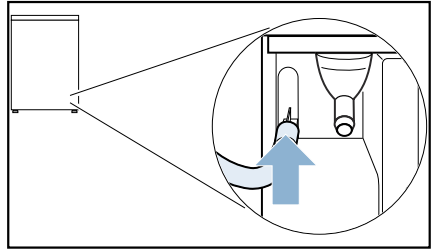

5. Take the drain hose from the accessories and attach it to the free socket, pushing it up to the stop.

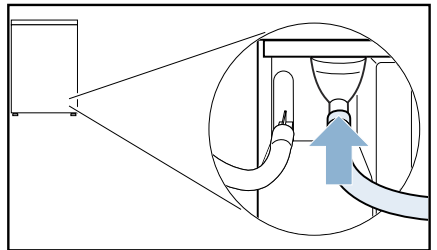

en Draining the condensation water

6. Secure the other side of the drain hose using the remaining accessories, depending on the connection situation.

Washbasin:

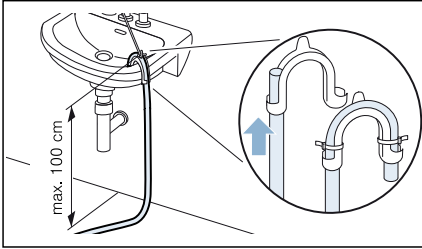

Siphon:

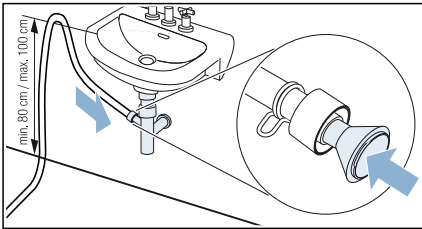

The connection point must be secured using a hose clamp (12-22 mm clamping range, available from specialist retailers). When connecting to a siphon, make sure that the drain hose is routed at a height of at least 80 cm, but no more than 100 cm.

Floor drain:

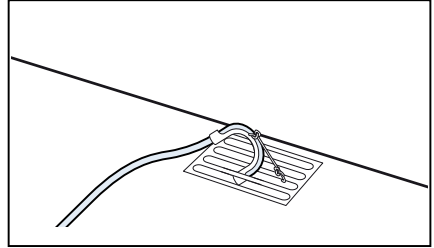

Caution!

Risk of material damage due to leaks or draining water.

Secure the drain hose to prevent it from slipping out. Do not kink or bend the drain hose. The height difference between the surface on which the appliance is installed and the drain hose must be no more than 100 cm.

Caution!

Risk of accumulated water being drawn back into the appliance and causing material damage.

Check that the water drains away quickly. The drain must not be sealed or blocked.

7. Pull out the condensation container horizontally and empty it.

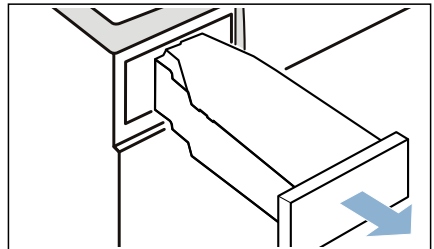

8. Turn the condensation container 180° onto its underside and remove the stopper that is fitted.

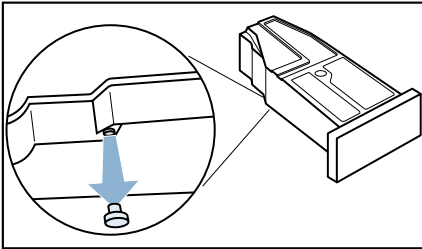

9. Turn the condensation container 180° again and insert the stopper into the recess in the top of the condensation container.

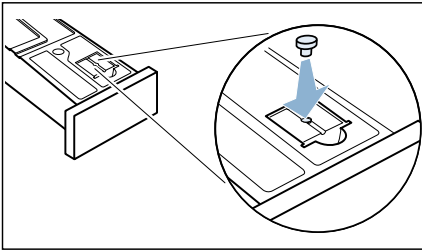

10. Pull the filter out of its snap-in lock.

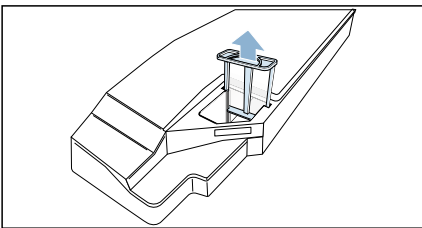

11. Place the filter into the recess on the condensation container.

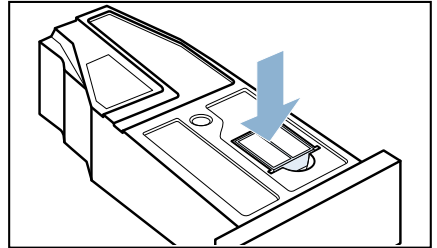

12. Slide in the condensation container until it clicks into place.

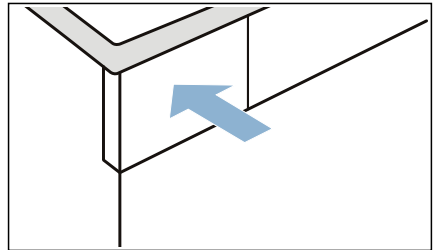

The condensation water is now discharged via the drain hose into the waste-water system or into a washbasin.

Note: If you want to drain the condensation water back into the condensation container, reverse these steps.

Caution!
Risk of material damage/damage to the appliance

If you are draining condensation water into the condensation container, liquid may leak out of the socket and cause material damage. Before operating the appliance, make sure that the condensation hose is secured to the socket.



Cleaning and maintenance

Cleaning the appliance



Warning **Risk of death!**

The appliance is powered by electricity. There is a risk of electric shock if you come into contact with live components. Therefore please note:

- Switch off the appliance. Disconnect the appliance from the power supply (pull out the plug).
- Never take hold of the mains plug with wet hands.
- When removing the mains plug from the socket, always take hold of the plug itself and never the mains cable, otherwise this may damage the mains cable.
- Do not make any technical modifications to the appliance or its features.
- Repairs and any other work on the appliance must only be conducted by our customer service or by an electrician. The same applies for replacing the mains cable (when necessary).
- Spare mains cables can be ordered from our customer service.



Warning **Risk of poisoning!**

Poisonous fumes may be given off by cleaning agents that contain solvents, e.g. cleaning solvent. Do not use cleaning agents that contain solvents.



Warning **Risk of electric shock/material damage/damage to the appliance!**

If moisture penetrates the appliance, this may cause it to short circuit. Do not use a pressure washer, steam cleaner, hose or spray gun to clean your appliance.

Caution!

Material damage/damage to the appliance

Cleaning agents and agents for pretreating laundry (e.g. stain removers, prewash sprays, etc.) may cause damage if they come into contact with the surfaces of the appliance. Therefore please note:

- Do not allow these agents to come into contact with the surfaces of the appliance.
- Clean the appliance with nothing but water and a soft, damp cloth.
- Remove any detergent, spray or other residues immediately.

Cleaning the moisture sensor

Note: The moisture sensor measures the amount of moisture in the laundry. After long periods of usage, the moisture sensor may become covered by a fine layer of limescale or detergent and care product residue. These deposits must be removed regularly, otherwise the drying results may not be optimal.

1. Open the door.

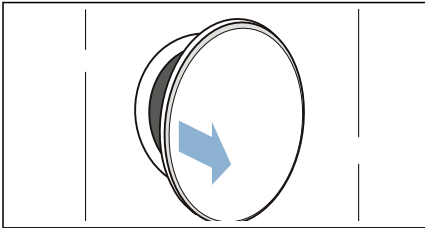

2. Clean the moisture sensor with a rough sponge.

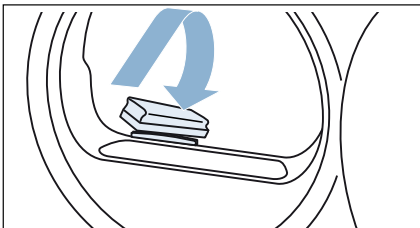

Caution!

Risk of damaging the moisture sensor.

The moisture sensor is made from stainless steel. Do not clean the sensor with abrasive cleaning products or wire wool.

Cleaning the filter in the condensation container

Note: The filter in the condensation container cleans the condensation water, which is used during the appliance's automatic cleaning cycle.

1. Pull out the condensation container horizontally.

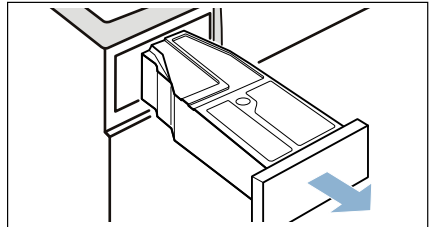

2. Pour out the condensation water.
3. Remove the filter.

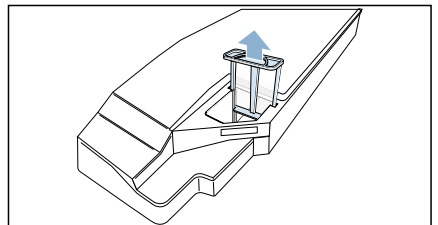

en Cleaning and maintenance

4. Clean the filter under warm, running water or in the dishwasher.
5. Push the filter in until you feel it lock into place.

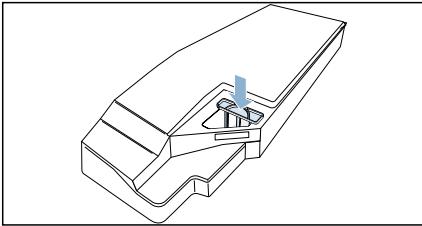

Caution!

If the filter is not inserted, fluff can find its way inside the appliance and damage it.

Only operate the appliance with the filter inserted.

6. Push the condensation container in until you feel it lock into place.

Cleaning the air channel

You can clean the appliance's air channel if it has fluff in it, for example.

Clean the air channel as follows:

1. Open the door and remove all fluff from it.
2. Remove the laundry.

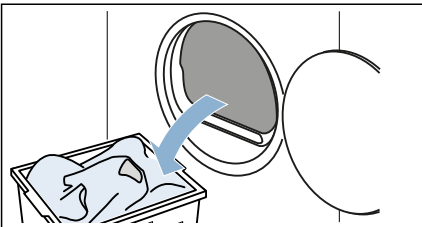

3. Remove the air channel cover vertically.

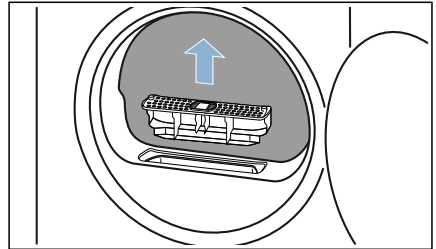

4. Clean the opening in the appliance with a soft, damp cloth.

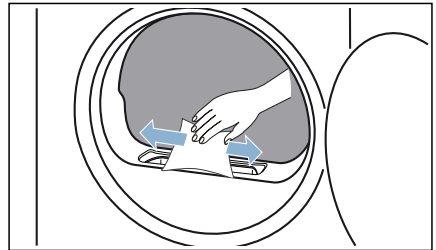

**⚠ Warning
Risk of injury!**

Your arm may become trapped or injured when cleaning the appliance if you place it in the air channel. Do not place your arm in the air channel.

5. Rinse the air channel cover under running water and dry it.

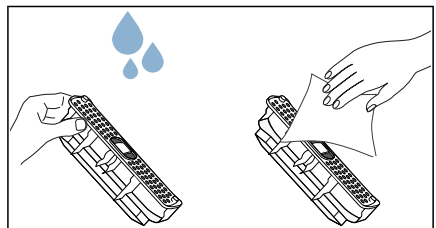

Notes

- Ensure that all fluff has been fully removed.
- For heavier dirt, you can use a soft brush to clean it.

6. Insert the air channel cover until you feel it lock into place.

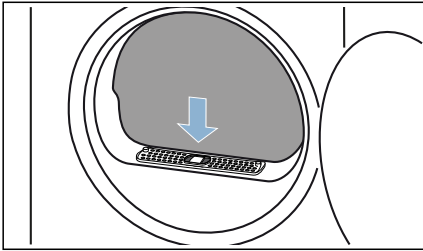

Caution!

Risk of material damage and damage to the appliance

Operating with a missing or defective air channel cover may lead to material damage and damage to the appliance if, for example, laundry gets into the air channel.

Do not operate the appliance if the air channel cover is missing or is defective.

You have cleaned the appliance's air channel.

Cleaning the base unit

When drying laundry, fluff and hair from the laundry is collected in the fluff collector. Your appliance's display reports that the fluff collector is full. Clean the appliance's base unit if the following message appears in the display: **Lint filter full. Length of drying cycle affected. Remove and empty the lint filter and the lint trap. Then clean both with warm water.**

You can also clean the appliance's base unit if this message does not appear in the display. e.g. before each time maintenance work is carried out on the appliance or the appliance is switched off for longer than a month.

Notes

- If the message **Lint filter full. Length of drying cycle affected. Remove and empty the lint filter and the lint trap. Then clean both with warm water.** appears in the display, confirm the message in the display.
- Allow the appliance to cool down for approximately 30 minutes after use before commencing cleaning.

Clean the base unit as follows:

1. To open the maintenance flap, take hold of it at the top at both sides and pull it down.

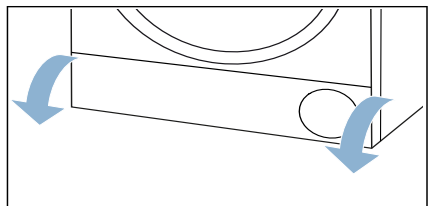

en Cleaning and maintenance

2. Clean the maintenance flap with a soft, damp cloth.

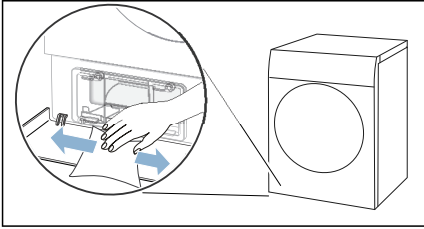

3. Unlock the levers on the heat exchanger cover.

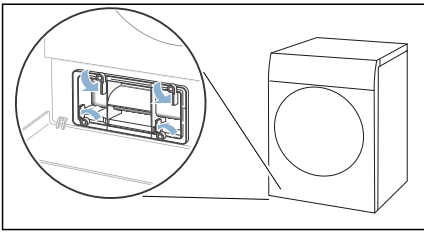

4. Pull the heat exchanger cover out by its grip.

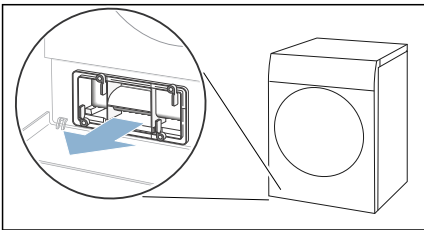

5. Remove all of the fluff from the heat exchanger cover and remove the fluff filter.

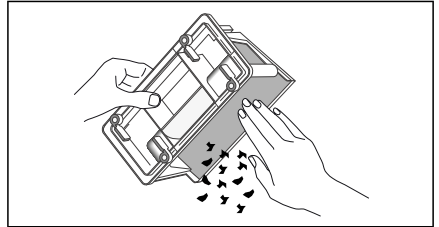

Note: Ensure that no dirt remains on the seals of the heat exchanger cover.

6. Rinse the inside of the heat exchanger cover and the fluff filter under running water and dry them.

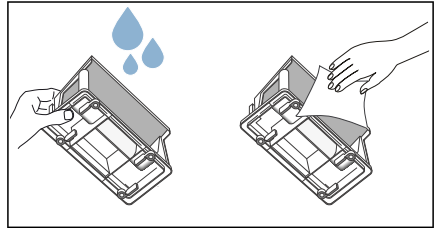

Notes

- Ensure that all fluff has been fully removed.
- For heavier dirt, you can use a soft brush to clean it.

7. Pull the fluff collector out horizontally.

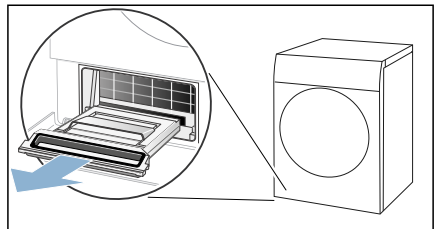

Note: The fluff collector may contain fluff and residual water, which may drip out of it when you pull it out.

8. Open the fluff collector and remove any fluff.

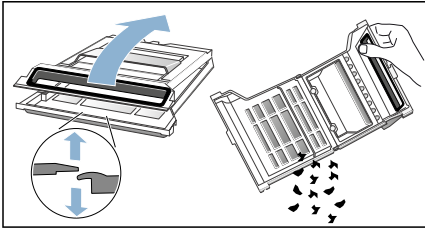

Note: If you want to dismantle the fluff collector to make it easier to clean, use the pin to lift one of the tabs and separate the upper and lower section.

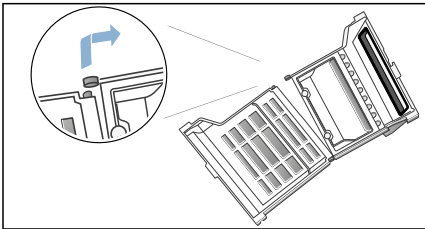

9. Rinse the fluff collector's filter under running water and dry it.

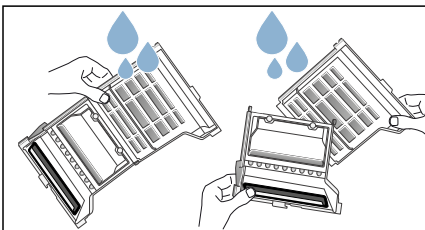

Notes

- Ensure that all fluff has been fully removed.
- For heavier dirt, you can use a soft brush to clean it.
- You must not remove or damage the fluff collector's seal.
- You can also clean the fluff collector in the dishwasher.

10. Clean the opening in the appliance with a soft, damp cloth.

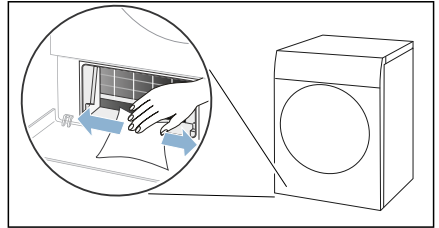

Note: Be careful not to damage the heat exchanger, as it is exposed.

11. Reassemble the separated fluff collector by inserting the pins into the tabs one after the other.

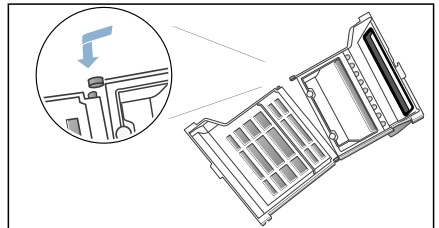

12. Close the fluff collector.

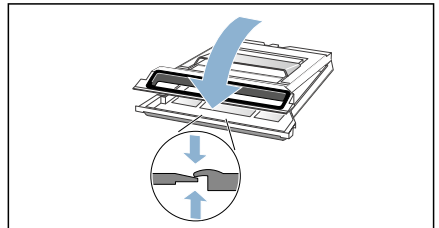

Note: Ensure that you close the fluff collector fully.

- 13.** Slide the fluff collector in horizontally as far as it will go.

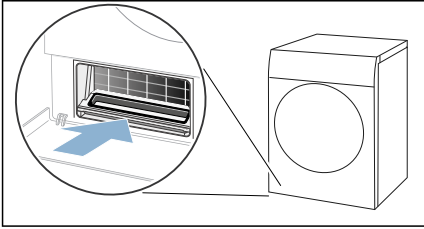

- 14.** Slide the heat exchanger cover in by its grip.

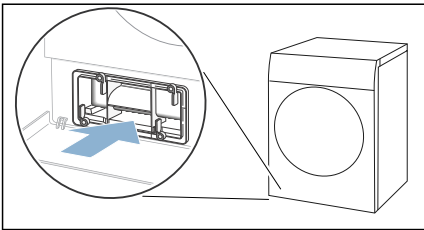

Note: You can only slide the heat exchanger cover in if the fluff collector is in the appliance.

- 15.** Lock the levers on the heat exchanger cover.

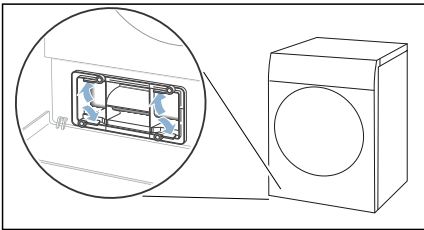

- 16.** Close the maintenance flap.

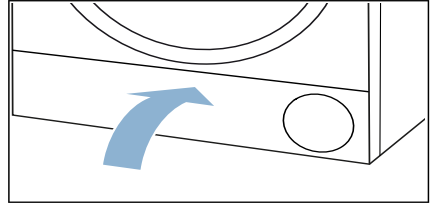

You have now finished cleaning the appliance's base unit.

Caution!
Material damage/damage to the appliance

If you operate the appliance without a fluff catcher (e.g. fluff filter, fluff depot, depending on appliance specifications), or if the fluff catcher is incomplete or defective, this may result in damage to the appliance.

Do not operate the appliance without a fluff catcher, or with a fluff catcher that is incomplete or defective.

Appliance care

The appliance offers the following settings for the appliance care programme:

You can use the appliance setting **Quick Care** to call up and run the basic appliance care programme. As a result, you can achieve long-term optimal drying results.

You can use the appliance setting **Indepth Care** to call up and run the intensive appliance care programme. This prevents any unpleasant odours from building up in the appliance after a long period of downtime.

Before running the appliance care programme, the appliance must be suitably prepared.

Warning

Risk of scalding/material damage/damage to the appliance!

Boiling or hot water can cause severe scalding as well as material damage and damage to the appliance if it is spilled or leaks out.

Do not use boiling water for this appliance or its components or accessories. Do not allow hot water or steam to come into contact with your skin.

Warning

Risk of poisoning/material damage!



Condensation water is not suitable for drinking and may be contaminated with lint. Contaminated condensation water may be hazardous to health and may cause material damage. Do not drink or reuse.

Preparing the appliance for appliance care

Preparing the appliance for appliance care

The appliance must be prepared **before** you can run a basic or intensive appliance care programme.

Prepare the appliance for appliance care as follows:

1. Clean the base unit. → *Page 57*
2. Press  to switch on the appliance.
3. Press  to open the door.
4. Remove the laundry.

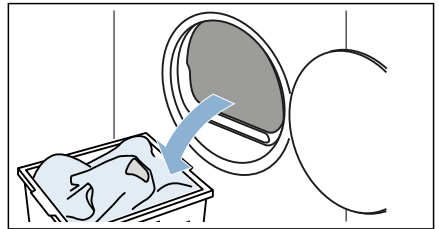

5. Close the door.
6. Pull out the condensation container horizontally and empty it.

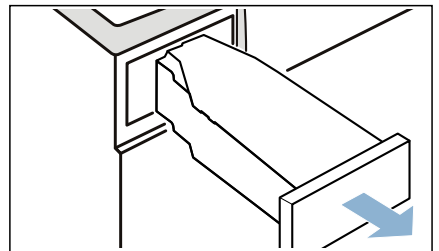

The appliance is now ready to run the appliance care programme.

Preparing the condensation container for appliance care

If you are draining the condensation water from the appliance using the drain hose, the condensation container must be prepared **before** the basic or intensive appliance care programme can be run.

Prepare the condensation container for appliance care as follows:

1. Remove the filter from the recess on the condensation container.

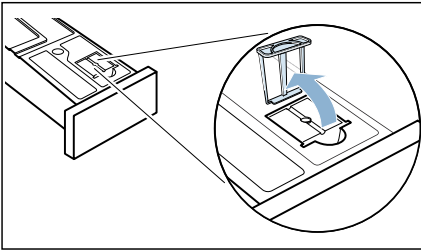

2. Remove the stopper inserted in the recess on the condensation container.

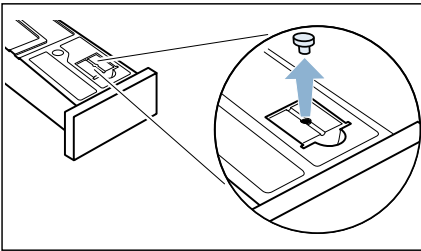

3. Turn the condensation container 180° onto its underside and insert the stopper.

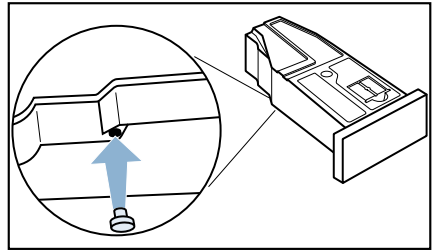

4. Push the filter in until you feel it lock into place.

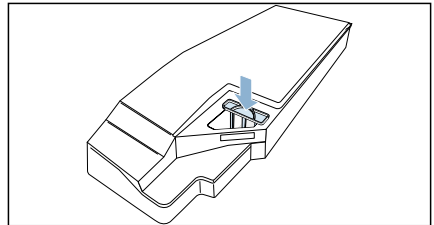

Caution!

If the filter is not inserted, fluff can find its way inside the appliance and damage it.

Only operate the appliance with the filter inserted.

The condensation container is now ready for the appliance care programme.

Note: If you are draining the condensation water from the appliance using the drain hose, reverse these steps **after** running the basic or intensive appliance care programme.



Running the basic appliance care programme

You can use the appliance setting **Quick Care** to call up and run the basic appliance care programme. As a result, you can achieve long-term optimal drying results.

Calling up the appliance care programme

You can call up the basic appliance care programme via a menu or a message that automatically appears in the display after you have been using the appliance for some time.

Call up the appliance care programme as follows via the menu:

1. Prepare the appliance for appliance care. → *Page 61*
2. Press  or press and hold  and swipe upwards.

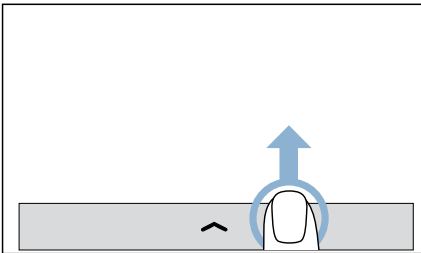

A menu is displayed.

3. Press .
4. Swipe until **Quick Care** appears.

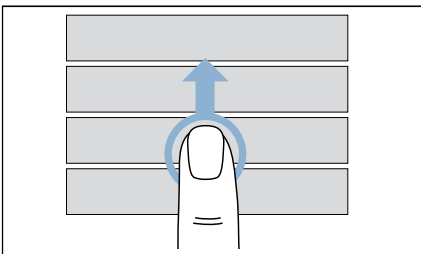

5. Press **Quick Care** .
A message appears in the display.
6. Confirm the messages in the display.
You can now run the appliance care programme.

Call up the appliance care programme as follows via the message:

Note: After this appliance usage time, the display automatically shows the message: **Quick Care should be performed. Providing optimal drying results every time. The total duration will be ca. 40min..** You can call up the basic appliance care programme via this message.

1. Prepare the appliance for appliance care. → *Page 61*
2. Confirm the message in the display.

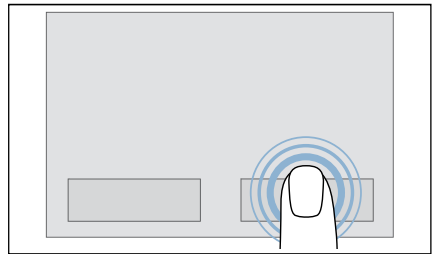

Note: You can also cancel the basic appliance maintenance and postpone it to a later time. This message then reminds you to carry out the basic appliance care programme in its entirety.

You can now run the appliance care programme.

Note: Press  to return to the higher-level screen.

Running the appliance care programme

Run the appliance care programme as follows:

1. Pour approx. 1 ½ litre of warm tap water into the condensation container.

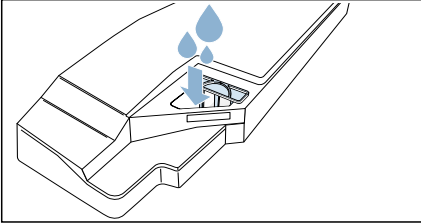

Note: Hold the full condensation container horizontally at all times so that no liquid spills out.

2. Slide in the condensation container until it clicks into place.

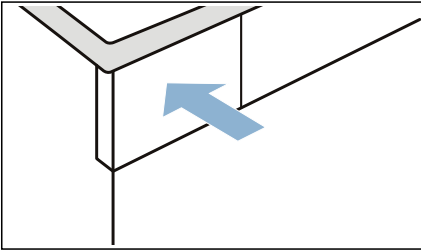

3. Press  (Start/Pause). The appliance care programme starts and an audible signal sounds.

Note: During the appliance care programme, you cannot pause the appliance via  (Start/Pause).

A message appears in the display once the appliance care programme has ended, and an audible signal sounds.

4. Pull out the condensation container horizontally and empty it.

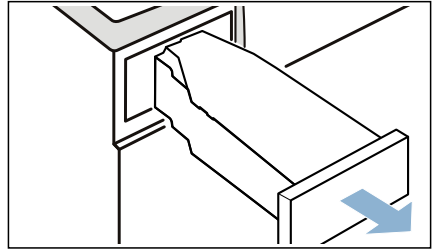

5. Slide in the condensation container until it clicks into place.

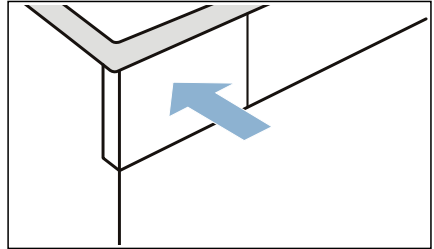

6. Press  for standby mode. You have now completed the appliance care programme.

Running the intensive appliance care programme

You can use the appliance setting **Indepth Care** to call up and run the intensive appliance care programme. This prevents any unpleasant odours from building up in the appliance after a long period of downtime.

Notes

- The intensive appliance care programme runs for approximately 4 hours. The programme may take longer if you do not carry out the necessary steps in good time while the programme is running.
- Once it has started, the intensive appliance care programme should not be cancelled.
- When you run the intensive appliance care programme, you will need to use the original appliance care product. This can be ordered from our after-sales service using spare part number **00311829**. Contact information for all countries can be found in the enclosed after-sales service directory.

Warning **Risk of injury/material damage/damage to the appliance!**



The use of spare parts and accessories supplied by other brands is dangerous and may result in injury, material damage or damage to the appliance. For safety reasons, use genuine spare parts and accessories only.

Caution! **Material damage/damage to the appliance**

If you pour the wrong quantity of detergent or cleaning agent into the appliance, this may result in material damage or damage to the appliance. Use detergents/care products/cleaning agents and softeners in accordance with the manufacturers' instructions.

Calling up the appliance care programme

Call up the appliance care programme as follows via the menu:

1. Prepare the appliance for appliance care. → *Page 61*
2. Press  or press and hold  and swipe upwards.

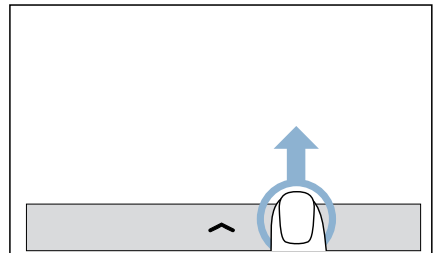

A menu is displayed.

3. Press .
4. Swipe until **Indepth Care** appears.

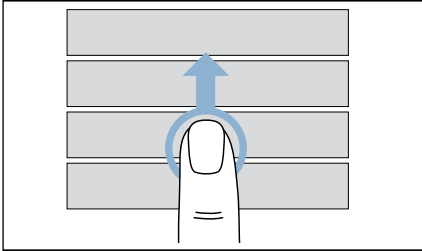

5. Press **Indepth Care**.
6. Confirm the messages in the display. You can now run the appliance care programme.

Note: Press  to return to the higher-level screen.

Running the appliance care programme

Run the appliance care programme as follows:

1. Pour a bottle of the original appliance care product and approx. 1 ½ litre of warm tap water into the condensation container.

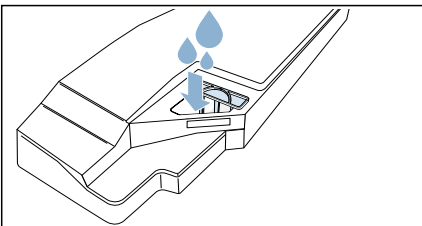

Note: Hold the full condensation container horizontally at all times so that no liquid spills out.

2. Slide in the condensation container until it clicks into place.

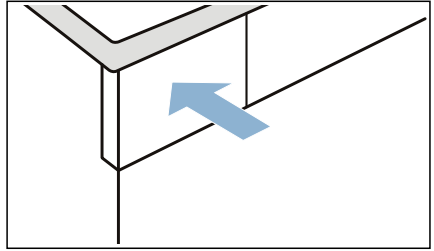

3. Press  (Start/Pause). The appliance care programme starts and an audible signal sounds.

Note: During the appliance care programme, you cannot pause the appliance via  (Start/Pause).

After some time, the appliance pauses the appliance care programme and a message appears in the display informing you that the first part of the appliance care programme has been carried out.

4. Confirm the messages in the display.
5. Pull out the condensation container horizontally and empty it.

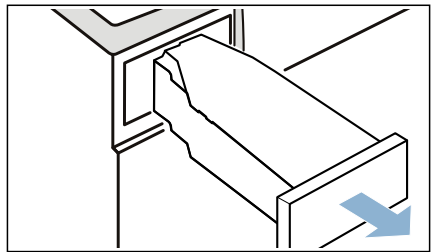

6. Pour approx. 1 ½ litre of warm tap water into the condensation container.

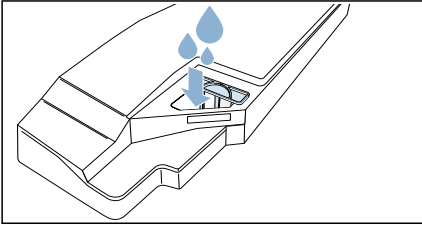

Note: Hold the full condensation container horizontally at all times so that no liquid spills out.

7. Carefully swing the condensation container round horizontally and empty it to dispose of any remaining original appliance care product.

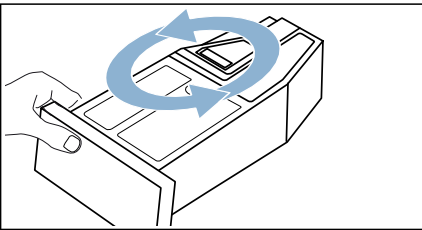

8. Pour approx. another 1 ½ litre of warm tap water into the condensation container.

9. Slide in the condensation container until it clicks into place.

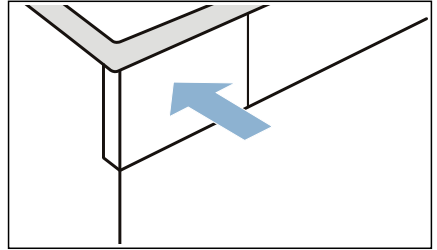

10. Press ▷||| (Start/Pause).
The appliance care programme is resumed.

Note: During the appliance care programme, you cannot pause the appliance via ▷||| (Start/Pause).

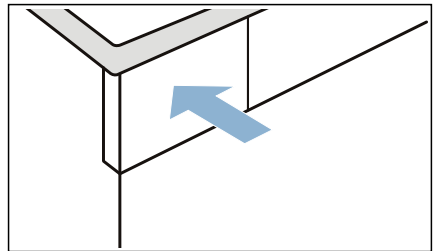

A message appears in the display once the appliance care programme has ended, and an audible signal sounds.

11. Empty the condensation container again.
12. Slide in the condensation container until it clicks into place.



13. Press ⏻ for standby mode.
You have now completed the appliance care programme.

Help with the appliance

Faults	Cause/remedy
The appliance will not start.	Check the mains plug and the fuses.
Water is leaking out.	<ul style="list-style-type: none"> ■ The appliance may be positioned at an angle. Level the appliance. ■ In the base unit, make sure that: <ul style="list-style-type: none"> - The heat exchanger cover is properly locked. - There is no dirt or debris on the heat exchanger cover's seal. → Page 57 ■ If the optional drain hose* is installed, make sure that the drain hose is correctly connected. → Page 51
No power. The door cannot be automatically opened.	Manually open the door → Page 33
The appliance is paused but the drum is turning.	The appliance has detected a high temperature and has started the CoolDown process. Temperature regulation can take up to 10 minutes. You can cancel the CoolDown process at any time by opening the door.
The programme will not start	<p>Make sure that:</p> <ul style="list-style-type: none"> ■ The door is closed. ■  has been deactivated ■ You have pressed  (Start/Pause) <p>Note: If the programme has been delayed by setting  (Ready in), the programme will start later.</p>
Programme duration displayed changes as drying progresses.	Not a fault. The moisture sensor measures the residual moisture in the laundry and adjusts the programme duration (with the exception of timed programmes).
Creasing.	<ul style="list-style-type: none"> ■ Load exceeded or incorrect programme selected for a type of fabric. All the required information can be found in the programme table. → Page 26 ■ Remove laundry from the drum as soon as the drying programme has finished. Creasing occurs when clothing is left in the drum.

<p>Laundry is not dried properly or is still too damp.</p>	<ul style="list-style-type: none"> ■ After the programme has ended, warm laundry feels damper than it actually is. Spread out the laundry and let it cool down. ■ Adjust the drying time or increase the degree of dryness. This will extend the drying time but the temperature will remain the same. ■ Select a timed programme to add extra drying time for laundry that is still damp. ■ Select a timed programme for a small load. ■ Do not exceed the maximum load for a programme. → <i>Page 26</i> ■ Clean the moisture sensor in the drum. The sensor may become covered in a fine layer of limescale or detergent and care product residue, which then impairs its performance. → <i>Page 55</i> ■ Drying has been interrupted as a result of a power cut, because the condensation container is full or because the maximum drying time has been exceeded. <p>Note: See also the laundry tips. → <i>Page 32</i></p>
<p>Drying is taking too long.</p>	<ul style="list-style-type: none"> ■ The appliance may have fluff in it. This will increase the required drying time. <ul style="list-style-type: none"> - Clean the base unit. → <i>Page 57</i> - Clean the air duct. → <i>Page 56</i> - Run a complete drying cycle with a load weighing more than 3 kg. Make sure that the laundry has not been pre-dried. <p>Note: The appliance's automatic self-cleaning function uses the condensed water from your laundry. If you regularly dry loads weighing less than 3 kg, there will not be enough condensed water from your laundry to run the appliance's automatic self-cleaning function. You should therefore dry loads weighing more than 3 kg on a regular basis, making sure that the laundry has not been pre-dried.</p> ■ The heat exchanger may have fluff in it. <ul style="list-style-type: none"> - Run the basic appliance care programme. → <i>Page 63</i> - If you can see fluff in the exposed heat exchanger, clean it carefully using a vacuum cleaner. ■ If the air inlet on the appliance is blocked or not fully open, this may increase the drying time. Make sure that the air inlet remains unobstructed. ■ If the ambient temperature is lower than 15 °C or higher than 30 °C, this may increase the drying time and affect the drying result. ■ Inadequate air circulation in the room may increase the drying time. Make sure the room is adequately ventilated.
<p>Unpleasant odour in the appliance</p>	<p>Run the intensive appliance care programme. → <i>Page 65</i></p>
<p>I am unable to connect to my home network.</p>	<ul style="list-style-type: none"> ■ Wi-Fi is switched off. To connect to your home network, switch on Wi-Fi.  must appear on the display. ■ Wi-Fi is switched on but a connection to your home network cannot be established. Check whether your home network is available or try to connect to your home network again.

Home Connect is not working.	<ul style="list-style-type: none">■ You can find solutions to problems with Home Connect at www.home-connect.com.■ The availability of the Home Connect functionality depends on the availability of the Home Connect Services (e.g. provision of the app) in your country. Home Connect Services are not available in every country – for further information please check: www.home-connect.com.
Humidity in the room is increasing.	Make sure the room is sufficiently ventilated.
Unusual noises when drying.	When drying is in progress, the pump and compressor generate noise when operating normally. This does not indicate that the appliance is malfunctioning.
The appliance feels cold despite drying.	Not a fault. The appliance can dry effectively at low temperatures using a heat pump.
Drying programme is stopped.	If the drying programme is stopped due to a power failure, restart the programme or remove the laundry and spread it out.
Residual water in the condensation container despite the appliance being connected to the drain hose*.	If the optional drain hose is installed, residual water remains in the condensation container due to the appliance's self-cleaning function.
* Depending on how the appliance is equipped or the available accessory	

Note: If you cannot rectify the fault yourself by turning the appliance off and then on again, please contact our after-sales service. → *Page 74*



Transporting the appliance

Warning

Risk of injury/material damage/ damage to the appliance!

If you take hold of any of the appliance's protruding parts (e.g. the appliance door) in order to lift or move it, these parts may break off and cause injury. Do not take hold of any of the appliance's protruding parts in order to move the appliance.

Warning

Risk of injury!

- The appliance is very heavy. Lifting it may result in injury. Do not lift the appliance on your own.
- The appliance has sharp edges on which you could cut your hands. Do not take hold of the appliance by its sharp edges. Wear protective gloves to lift it.

Prepare the appliance for transportation as follows:

1. Pull out the condensation container horizontally and empty it.

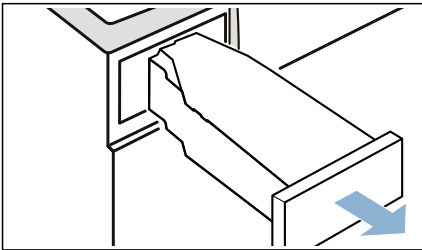

2. Push the condensation container back into the appliance until you feel it lock into place.

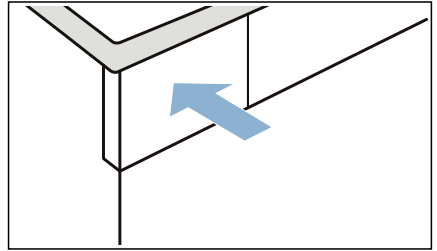

3. Switch on the appliance.
4. Set any programme. Your programme is now set and the corresponding **programme settings** are displayed.
5. Press  (Start/Pause).
6. Wait for 5 minutes. The condensation water will be drained.
7. Empty the condensation container again.
8. If installed, remove the drain hose from the washbasin, siphon or floor drain. → Page 51

Caution!

Secure the drain hose to the appliance to prevent it from slipping out. Do not kink the drain hose.

9. Press  for standby mode.
10. Disconnect the appliance's mains plug from the power supply.

The appliance is now ready to be transported.



Caution!

Risk of material damage/damage to the appliance

Despite draining, there will always be some residual water in the appliance. Any residual water may leak out and cause material damage. The appliance should therefore be transported upright.



Consumption values

Consumption values table

Programme	Spin speed used for spinning the laundry (in rpm)	Duration** (in min)		Energy consumption** (in kWh)	
		9 kg	4.5 kg	9 kg	4.5 kg
Cotton					
Cupboard Dry  *	1400	193	126	1.32	0.83
	1000	218	140	1.52	0.93
	800	244	154	1.72	1.03
Iron Dry  *	1400	134	89	0.92	0.58
	1000	159	103	1.12	0.68
	800	185	117	1.32	0.78
Easy-Care		3.5 kg		3.5 kg	
Cupboard Dry  *	800	62		0.39	
	600	76		0.48	
* Programme setting in accordance with the applicable EN61121 standard when using the external drain hose.					
** The values may differ from those specified, depending on the type of fabric, composition of laundry to be dried, residual moisture in the laundry, the degree of dryness that has been set, the amount of laundry being loaded, the environmental conditions, and any additional functions that have been activated.					

Most efficient programme for cotton laundry

The "standard cottons programme" below (denoted by the  symbol) is suitable for drying cotton laundry with a normal dampness level, and is the most efficient programme for drying damp cotton laundry in terms of combined energy consumption.

Standard programmes for cottons in accordance with current EU regulation 932/2012			
Programme + dryness level	Load (in kg)	Energy consumption (in kWh)	Programme duration (in min)
 Cotton + Cupboard Dry 	9/4.5	1.52/0.93	218/140
Programme setting for testing and energy labelling in accordance with Directive 2010/30/EU.			



Technical specifications

Dimensions:

850 x 600 x 640 mm

(height x width x depth)

Weight:

56 kg (depending on the model)

Mains connection:

Mains voltage 220 - 240 V, 50 Hz

Nominal current 10 A

Nominal power 800 W

Maximum load:

9 kg

Power consumption when switched off:

0.10 W

Power consumption when left on:

0.10 W

Drum interior light***Ambient temperature:**

10 - 35 °C

Power consumption when networked (Wi-Fi) in standby mode/duration:

2.3 W / 2.3 mins



Disposal



Dispose of packaging and the appliance in an environmentally responsible manner.

This appliance is labelled in accordance with the European Directive 2012/19/EU, which governs waste electrical and electronic equipment (WEEE). The directive provides a framework for the collection and recycling of old appliances, which is valid across the EU.

Caution!**Risk of fire/risk of poisoning/risk of material damage and damage to the appliance**

The appliance contains R290, a refrigerant that is environmentally friendly but flammable. If it is not disposed of correctly, this may result in fire or poisoning.

Dispose of the appliance correctly and do not damage the pipes in the refrigerant circuit.

* Depending on the appliance features



After-sales service

If you cannot rectify the fault yourself by turning the appliance off and then on again, please contact our after-sales service. → Enclosed after-sales service directory or cover page

We will always find an appropriate solution in order to avoid unnecessary visits by engineers.

Please provide the after-sales service with the product number (E no.) and the production number (FD) of the appliance.

E-Nr. _____	FD _____
-------------	----------

E no. Product number
FD Production number

You can find this information, depending on the model*:

On the inside of the door*/open service flap* and at the rear of the appliance.

Trust in the expertise of the manufacturer.

Contact us for assistance. By doing so, you can be sure that the repairs are carried out by trained service engineers using genuine spare parts.

Repair order and advice in the event of faults

GB 0344 892 8999 (Calls charged at local or mobile rate.)

IE 01450 2655 (0.03 € per minute at peak. Off peak 0.0088 € per minute.)

You can find the contact information for all countries in the attached after-sales service directory.

BSH Hausgeräte GmbH

Carl-Wery-Straße 34

81739 München

GERMANY

siemens-home.bsh-group.com

Manufactured by BSH Hausgeräte GmbH under Trademark License of Siemens AG



9001389282 (9804)