

Use and care
GUIDE

Masterpiece® Series Combination Steam Oven

MES301HS MES301HP



Table of CONTENTS

About This Manual	4	How to Obtain Service or Parts	29
How This Manual is Organized	4	Getting the Most Out of Your Appliance	30
▲ Safety Definitions	4	General Tips	30
IMPORTANT SAFETY INSTRUCTIONS	5	Cooking Charts	31
Proper Installation and Maintenance	5	STATEMENT OF LIMITED PRODUCT WARRANTY ...	41
Fire Safety	6	What this Warranty Covers & Who it Applies to	41
Burn Prevention	6	How Long the Warranty Lasts	41
Child Safety	6	Repair/Replace as Your Exclusive Remedy	41
Cleaning Safety	7	Out of Warranty Product	41
Cookware Safety	7	Warranty Exclusions	41
Proposition 65 Warning	7		
Causes of damage	8		
Your New Appliance	8		
Control Panel	8		
Oven cavity	10		
Cooling Fan	10		
Oven Vent	10		
Convection Fan	10		
Accessories	10		
Operation	11		
Before Using the Appliance for the First Time	11		
Fill water tank	12		
Operating the Appliance	12		
Automatic Shutoff	13		
Clock and Timer Settings	14		
Automatic Programming - EasyCook	16		
Favorites	21		
Panel Lock	21		
Basic Settings	21		
Cleaning and Maintenance	23		
Cleaning	23		
Steam Clean	24		
Decalcify	24		
Removing and Installing the Appliance Door	25		
Cleaning the Door Glass	26		
Clean racks	27		
Replacing the Door Gasket	27		
Service	28		
Before Calling for Service	28		
Technical service	29		

This THERMADOR Appliance is made by
 BSH Home Appliances Corporation
 1901 Main Street, Suite 600
 Irvine, CA 92614

Questions?

1-800-735-4328

www.thermador.com

We look forward to hearing from you!

About This Manual

How This Manual is Organized

You can get the most out of your new oven by reading this manual from beginning to end. This way you will systematically get to know your appliance and become familiar with its operation and features.

The manual consists of the following sections:

- The “Safety” section provides information on how to safely operate your oven.
- “Your New Appliance” introduces you to the oven components and features.
- The “Operation” section offers you step-by-step instructions on how to operate your oven.

- “Cleaning and Maintenance” provides you with information on how to clean and care for the various oven parts.
- The “Service” section includes do-it-yourself troubleshooting tips.
- In “Getting the Most Out of Your Appliance” you can find a list of many common foods with the appropriate heating mode, temperature, rack position and cook time. This section also provides you with several bakeware and preparation tips.
- The “Warranty” section contains information on your product warranty.

Pay special attention to the important safety instructions in the “Safety” section.

▲ Safety Definitions

▲ WARNING

This indicates that death or serious injuries may occur as a result of non-observance of this warning.

▲ CAUTION

This indicates that minor or moderate injuries may occur as a result of non-observance of this warning.

NOTICE: This indicates that damage to the appliance or property may occur as a result of non-compliance with this advisory.

Note: This alerts you to important information and/or tips.

IMPORTANT SAFETY INSTRUCTIONS

READ AND SAVE THESE INSTRUCTIONS

IMPORTANT SAFEGUARDS

SAVE THESE INSTRUCTIONS.

WARNING

When properly cared for, your new appliance has been designed to be safe and reliable. Read all instructions carefully before use. These precautions will reduce the risk of burns, electric shock, fire, and injury to persons. When using kitchen appliances, basic safety precautions must be followed, including those in the following pages.

Proper Installation and Maintenance

Have the installer show you the location of the circuit breaker or fuse. Mark it for easy reference.

This appliance must be properly installed and grounded by a qualified technician. Connect only to properly grounded outlet. Refer to Installation Instructions for details.

This appliance is intended for normal family household use only. It is not approved for outdoor use. See the Statement of Limited Product Warranty. If you have any questions, contact the manufacturer.

This appliance is intended to be used in household and similar applications such as:

- staff kitchen areas in shops, offices and other working environments;
- farm houses;
- by clients in hotels, motels and other residential type environments;
- bed and breakfast type environments.

Do not store or use corrosive chemicals, vapors, flammables or nonfood products in or near this appliance. It is specifically designed for use when heating or cooking food. The use of corrosive chemicals in heating or cleaning will damage the appliance and could result in injury.

Do not operate this appliance if it is not working properly, or if it has been damaged. Contact an authorized servicer.

Do not obstruct oven vents.

Do not repair or replace any part of the appliance unless specifically recommended in this manual. Refer all servicing to an authorized servicer.

In the event of an error the display flashes and beeps continuously. If this happens during self-clean, disconnect appliance from the power supply and call a qualified technician.

In the event of an error the display flashes and beeps continuously. Disconnect appliance from the power supply and call an authorized servicer.

WARNING

When removing the door make sure oven is cool and power to the oven has been turned off before removing the door. Failure to do so could result in burns.

The oven door is heavy and fragile. Use both hands to remove the oven door. The door front is glass. Handle carefully to avoid breaking.

Grasp only the sides of the oven door. Do not grasp the handle as it may swing in your hand and cause injury or damage.

Failure to grasp the oven door firmly and properly could result in personal injury or product damage.

Lay the door on a flat smooth surface so that the door cannot fall over. Failure to do so may result in personal injury or damage to the appliance.

WARNING

To avoid injury from hinge bracket snapping closed, be sure that both levers are securely in place before removing door. Also, do not force door open or closed - the hinge could be damaged and injury could result.

WARNING

Make sure the appliance and lights are cool and power to the appliance has been turned off before replacing the light bulb(s). Failure to do so could result in electrical shock or burns. The lenses (if equipped) must be in place when using the appliance. The lenses (if equipped) serve to protect the light bulb from breaking. The lenses (if equipped) are made of glass. Handle carefully to avoid breaking. Broken glass can cause an injury.

WARNING

Light socket is live when door is open if main power supply is not turned off.

WARNING

Risk of short circuiting! Never allow electrical appliance cords to become pinched in the hot appliance door. The cord's insulation can melt.

IMPORTANT SAFETY INSTRUCTIONS

READ AND SAVE THESE INSTRUCTIONS

Fire Safety

WARNING

NEVER cover any slots, holes or passages in the oven bottom or cover an entire rack with materials such as aluminum foil. Doing so blocks air flow through the oven. Aluminum foil linings may also trap heat, causing a fire hazard.

If materials inside an oven or warming drawer should ignite, keep door closed. Turn off the appliance and disconnect the circuit at the circuit breaker box.

WARNING

Use this appliance only for its intended use as described in this manual. NEVER use this appliance as a space heater to heat or warm the room. Doing so may result in overheating the appliance. Never use the appliance for storage.

Always have a working smoke detector near the kitchen. In the event that personal clothing or hair catches fire, drop and roll immediately to extinguish flames.

Have an appropriate fire extinguisher available, nearby, highly visible and easily accessible near the appliance.

Smother flames from food fires other than grease fires with baking soda. Never use water on cooking fires.

WARNING

TO REDUCE THE RISK OF INJURY TO PERSONS IN THE EVENT OF A GREASE FIRE, OBSERVE THE FOLLOWING:

- a. SMOTHER FLAMES with a close-fitting lid, cookie sheet, or metal tray, then turn off the burner. BE CAREFUL TO PREVENT BURNS. If the flames do not go out immediately, EVACUATE AND CALL THE FIRE DEPARTMENT.
 - b. NEVER PICK UP A FLAMING PAN – You may be burned.
 - c. DO NOT USE WATER, including wet dishcloths or towels – a violent steam explosion will result.
 - d. Use an extinguisher ONLY if:
 - You know you have a Class ABC extinguisher, and you already know how to operate it.
 - The fire is small and contained in the area where it started.
 - The fire department is being called.
 - You can fight the fire with your back to an exit.
-

Burn Prevention

DO NOT TOUCH HEATING ELEMENTS OR INTERIOR SURFACES OF OVEN - Heating elements may be hot even though they are dark in color. Interior surfaces of an oven become hot enough to cause burns. During and after use, do not touch, or let clothing, potholders, or

other flammable materials contact heating elements or interior surfaces of oven until they have had sufficient time to cool. Other surfaces of the appliance may become hot enough to cause burns. Among these surfaces are oven vent openings, surfaces near these openings and oven doors.

Exercise caution when opening the appliance. Standing to the side, open the door (or drawer) slowly and slightly to let hot air and/or steam escape. Keep your face clear of the opening and make sure there are no children or pets near the unit. After the release of hot air and/or steam, proceed with your cooking. Keep doors shut unless necessary for cooking or cleaning purposes. Do not leave open doors unattended.

Do not heat or warm unopened food containers. Build-up of pressure may cause the container to burst and cause injury.

Use caution when cooking foods with high alcohol content (e.g. rum, brandy, bourbon) in the oven. Alcohol evaporates at high temperatures. There is a risk of burning as the alcohol vapors may catch fire in the oven. Use only small quantities of alcohol in foods, and open the oven door carefully.

Always place oven racks in desired location while oven is cool. Always use oven mitts, when the oven is warm. If a rack must be moved while oven is hot, do not let potholder contact the heating elements.

Always use dry potholders. Moist or damp potholders on hot surfaces may result in burns from steam. Do not let potholder touch hot heating elements. Do not use a towel or other bulky cloth.

Secure all loose garments, etc. before beginning. Tie long hair so that it does not hang loose, and do not wear loose fitting clothing or hanging garments, such as ties, scarves, jewelry, or dangling sleeves.

Use pot holders to remove inserted cooking accessories from the hot oven. Hot liquid may spill over when removing the cooking accessories.

Hot steam can escape when opening the oven door. Hot water may drip from the door. Keep children away.

Hot steam can escape during use. Do not touch the ventilation openings.

Child Safety

When children become old enough to use the appliance, it is the responsibility of the parents or legal guardians to ensure that they are instructed in safe practices by qualified persons.

Do not allow anyone to climb, stand, lean, sit, or hang on any part of an appliance, especially a door, warming drawer, or storage drawer. This can damage the appliance, and the unit may tip over, potentially causing severe injury.

Do not allow children to use this appliance unless closely supervised by an adult. Children and pets should not be left alone or unattended in the area where the appliance is in use. They should never be allowed to play in its vicinity, whether or not the appliance is in use.

IMPORTANT SAFETY INSTRUCTIONS

READ AND SAVE THESE INSTRUCTIONS

CAUTION

Items of interest to children should not be stored in an appliance, in cabinets above an appliance or on the backsplash. Children climbing on an appliance to reach items could be seriously injured.

Cleaning Safety

Risk of severe burns! Do not clean the appliance immediately after turning it off. The water in the evaporator dish is still hot. Wait until the appliance has cooled down.

Keep oven free from grease build up.

WARNING

RISK OF INJURY

Scratched glass in the appliance door can burst. Do not use any glass scrapers or strong or abrasive cleaning agents.

WARNING

RISK OF ELECTRICAL SHOCK

Moisture entering the appliance can cause an electrical shock. Don't use a high-pressure cleaner or steam cleaner.

Cookware Safety

Do not place food directly on oven bottom.

Follow the manufacturer's directions when using cooking or roasting bags.

Ovenware must be heat and steam resistant. Silicone baking pans are not suitable for Combination mode.

When using Steam mode with a perforated cooking pan, always slide the baking pan underneath it. The pan will catch any drippings.

The oven bottom and the evaporator dish must always remain clear. Always place ovenware on the rack or in the perforated cooking pan.

Proposition 65 Warning:

This product may contain a chemical known to the State of California, which can cause cancer or reproductive harm. Therefore, the packaging of your product may bear the following label as required by California:

STATE OF CALIFORNIA PROPOSITION 65 WARNING:



Cancer and Reproductive Harm - www.P65Warnings.ca.gov

Causes of damage

- Do not place anything directly on the oven bottom. Do not line it with aluminum foil. Heat build-up can damage the appliance.
- The oven bottom and the evaporator dish should always remain clear. Always place dishes in a perforated baking pan or on a rack.
- Aluminum foil may not contact the door pane in the oven. This can cause permanent discoloration of the door pane.
- Dishes must be heat and steam resistant. Silicone baking dishes are not suited for combination operation with steam.
- Do not use dishes with rust spots. Even the smallest spots can lead to corrosion in the oven.
- When steaming with a perforated baking pan, always push the baking sheet or the unperforated baking pan beneath it. This will catch drippings.
- Do not leave moist groceries in a closed oven for an extended period of time. It can lead to corrosion inside the oven.
- Fruit juice can leave stains in the oven. Always remove fruit juice immediately and wipe up first with a damp and then a dry cloth.
- If the door seal is very dirty, the appliance door will no longer close correctly. Nearby furniture can be damaged. Always keep the door seal clean and replace if necessary.
- Do not place anything on the open appliance door. This can damage the appliance.
- Do not hold or carry the appliance by the door handle. The door handle cannot carry the weight of the device and could break off.
- The appliance is made of high-grade stainless steel. Incorrect care can cause corrosion in the oven. Observe the care and cleaning instructions in the user manual. Remove dirt in the oven immediately after the appliance has cooled.

Your New Appliance

This section covers information on the following:

- Control panel
- Oven modes
- Oven and accessories

Control Panel

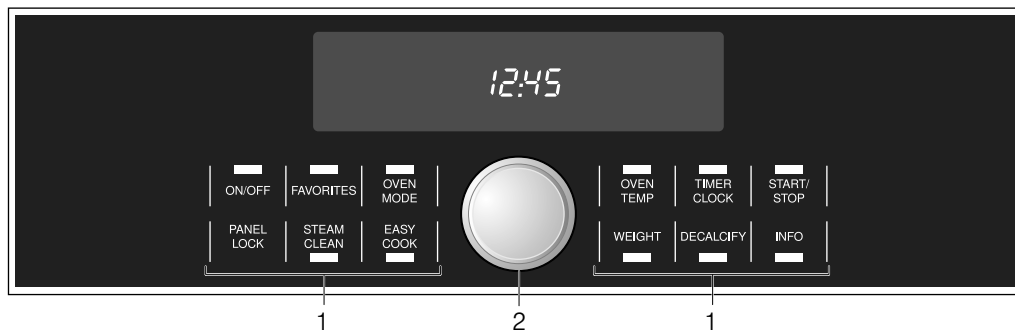

1	Touchpads
2	Settings Dial

Touchpads









You only have to press lightly on the touchpads to operate them. The touchpads will not work if you press several of them at once, such as when cleaning them.

ON/OFF	Turn the appliance on and off.
FAVORITES	Touch to select the Favorites menu. Touch and hold longer to store Favorites in memory.
OVEN MODE	Sets the oven mode.
PANEL LOCK	Touch and hold for four seconds to turn the panel lock on or off. Prevents the oven from being turned on or its settings from being changed accidentally.
STEAM CLEAN	Sets Steam Clean mode.

EASY COOK	Sets automatic programming.
OVEN TEMP	Set the temperature.
TIMER/CLOCK	Sets the timer function.
START/STOP	Touch briefly to start/pause operation. Touch and hold longer to cancel operation.
WEIGHT	Sets the weight for EasyCook automatic programming.
DECALCIFY	Sets Decalcify mode.
INFO	Touch briefly to view the current pre-heating temperature. Touch and hold longer to open or close the basic settings menu.

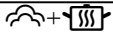
Oven Modes

Use the OVEN MODE touchpad to access the various oven modes of the appliance.

Oven mode	Temperature range	Display symbol	Use
True Convection	85 - 450 °F (30 - 230° C)		For moist cakes, sponge cakes, braised meat. A fan on the back wall distributes the heat evenly throughout the oven.
Steam	95 - 210 °F (35 - 100° C)		Vegetables, fish, side dishes; extracting fruit juice
Combination	250 - 450 °F (120 - 230° C)		Fish, soufflés and baked goods. Convection and Steam are combined
Reheat	210 - 360 °F (100 - 180° C)		Plated dishes and baked goods. Cooked food is gently reheated. The inflow of steam keeps the food moist.
Proof	95 - 120 °F (35 - 50° C)		Yeast dough and sour dough. The dough rises much faster than at room temperature. Steam and Convection are combined to keep the surface of the dough from drying out.
Defrost	95 - 140 °F (35 - 60° C)		Fruit, vegetables, meat and fish. Steam and Convection are combined. The humidity in the steamer oven gently transfers heat to the food. The food does not dry out or lose its shape.
Slow Cook	140 - 250 °F (60 - 120° C)		Roast beef, leg of lamb. Makes all types and cuts of meat extra tender.
Dish Warming	85 - 160 °F (30 - 70° C)		For ovenware and plates. Food in preheated ovenware does not cool down as quickly. Drinks stay warm longer.
Keep Warm	140 - 210 °F (60 - 100° C)		Keeps cooked food warm for up to one hour.

▲ CAUTION

WHEN USING KEEP WARM MODE, FOLLOW THESE GUIDELINES:

- Do not use the Keep Warm mode to heat cold food.
- Be sure to maintain proper food temperature. The USDA recommends holding hot food at 140 °F (60 °C) or warmer.
- DO NOT warm food longer than one hour.

Oven cavity

The oven has four levels. The levels are counted from the bottom up.

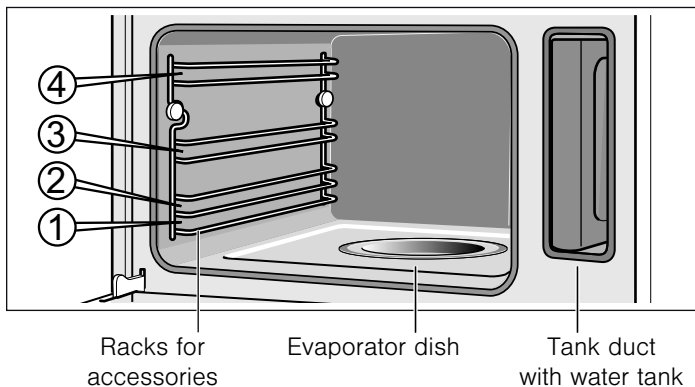

▲ CAUTION

- Do not place anything directly on the oven bottom. Do not line it with aluminum foil. Heat build-up can damage the appliance.
- The oven bottom and the evaporator dish should always remain clear. Always place dishes in a perforated baking pan or on a rack.
- Do not push accessories between the insertion levels, otherwise the appliance could tip.
- To avoid burns, place oven racks in desired positions before turning oven on. Always use oven mitts when the oven is warm. If a rack must be moved while the oven is hot, do not let oven mitts contact hot heating elements
- Use caution when removing oven racks from the lowest rack position to avoid contact with the hot oven door.

Cooling Fan

The cooling fan runs during all cooking modes. The fan can be heard when it is running, and warm air may be felt as it is released from the oven vent. The fan may also run after the oven is off.

Oven Vent

The oven vent is located at the bottom of the unit. Warm air may be released from the vent before, during and after cooking. It is normal to see steam escaping from the vent, and condensation may collect in this area. This area may be warm when the oven is in use. Do not block the vent, since it is important for air circulation.

Convection Fan

The convection fan operates during all convection modes. When the oven is operating in a convection mode, the fan turns off automatically when the door is opened. The convection fan may also run during Fast Preheat and Self-Clean.

Accessories

Use only the accessories supplied with the product or available from the after-sales service. They are specially designed for your appliance.

Your appliance is equipped with the following accessories:

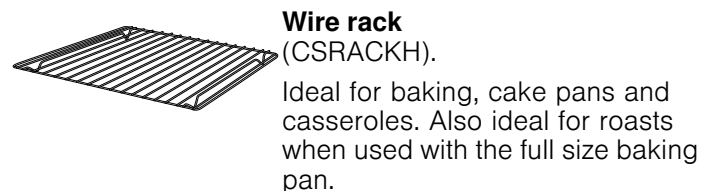
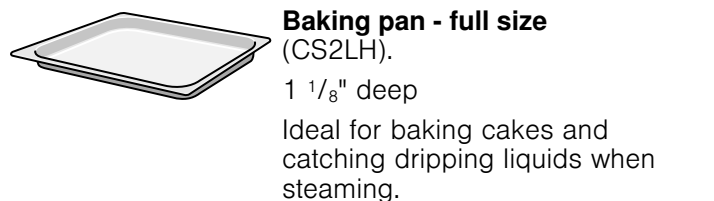
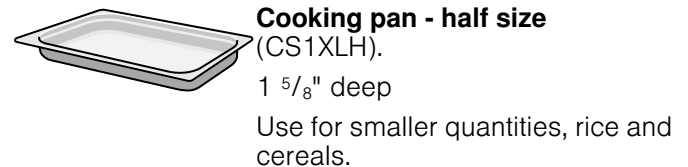
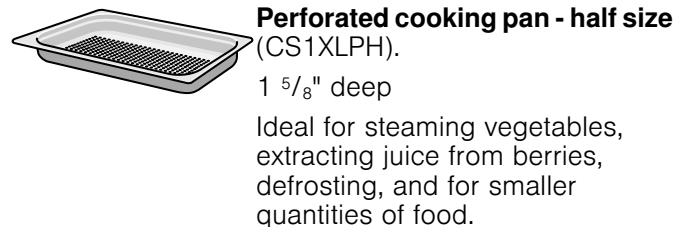
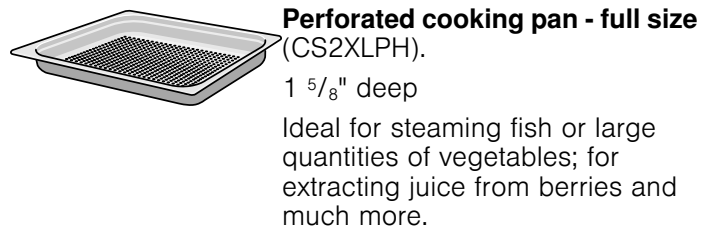

Additional accessories

The following additional accessories can be purchased in retail stores:

Accessory	Order no.
Perforated cooking pan - Full Size, 1 5/8" deep	CS2XLPH
Perforated cooking pan - Half Size, 1 5/8" deep	CS1XLPH
Cooking pan - Full Size, 1 5/8" deep	CS2XLH
Cooking pan - Half Size, 1 5/8" deep	CS1XLH

Accessory	Order no.
Baking pan - Full Size, 1 1/8" deep	CS2LH
Wire rack	CSRACKH
Powder descaler	310967

Note: The cooking pans may become warped during baking. This is due to major temperature fluctuations affecting the accessory. This may occur if food is placed on only one part of the accessory or a deep frozen item such as pizza has been placed on the accessory.

Operation

Before Using the Appliance for the First Time

- Appliance must be properly installed by a qualified technician before use.
- Remove all packing materials from inside and outside the oven.
- While cool, wipe with a clean, damp cloth and dry.
- There may be a slight odor from your new appliance; this is normal and will disappear after a short time.
- Optimum cooking results depend on proper cookware being used.
- Read and understand all safety precautions and Use and Care Manual information.

Execute the following sections prior to operating:

Setting the Clock

After plugging in the appliance, **12:00** flashes on the display.

Turn the settings dial to set the clock to the current time. The setting is automatically accepted after a few seconds.

Changing the time

1. Touch TIMER/CLOCK repeatedly until the arrow appears next to the clock symbol .
2. Use the settings dial to set the current time.
3. Touch TIMER/CLOCK to confirm.

Adjusting the Water Hardness Level

Descal the appliance using Decalcify mode at regular intervals. This can prevent damage to the appliance. The appliance automatically informs you when descaling is required. The factory setting is water hardness level II. Change the setting if your water is softer or harder.

Checking water hardness

You can ask your water utility company about the water hardness.

Softened water

Descaling is not required if you only use softened water. In this case, change the water hardness level to softened "0".

Changing the water hardness level

1. Touch and hold ON/OFF until the appliance turns on.
2. Touch and hold INFO for approximately 4 seconds. The initial basic setting **001** appears in the display.
3. Touch INFO repeatedly until **007** (water hardness level) appears in the display.
4. Use the settings dial to change the water hardness level.

Options:

-	softened	
1	1-soft	I
2	2-average	II
3	3-hard	III
4	4-very hard	IV

5. Touch and hold INFO for approximately 4 seconds. The change is stored.

Cleaning

Before initial use, heat up the appliance once while empty and clean the accessories.

Heating up the appliance

1. Fill and slide in the water tank.
2. Touch and hold ON/OFF to turn the appliance on. OVEN MODE lights up on the display.
3. Use the settings dial to set the oven mode to Steam .
4. Touch START/STOP to turn on the appliance. The appliance automatically heats up to 210 °F (100° C) and turns off after 20 minutes. A beep sounds.
5. Touch and hold ON/OFF until the appliance turns off. Leave the door open a crack until the appliance has cooled.

Cleaning accessories before use

Clean the accessories thoroughly with soapy water and a cloth before initial use.

Fill water tank

When you open the door, you'll see the water tank to the right.

NOTICE: Use of inappropriate liquids can damage the appliance!

- Only use fresh tap water, softened water, or mineral water without carbonation.
- If your tap water contains a lot of lime, we recommend softened water.
- Do not use distilled water, highly chlorinated tap water (> 40 mg/l), or any other liquids.

Information about your tap water can be obtained from your water utility office.

Fill the water tank before each use:

1. Open door and remove water tank (picture A).
2. Fill the water tank to the "max" line with cold water (picture B).

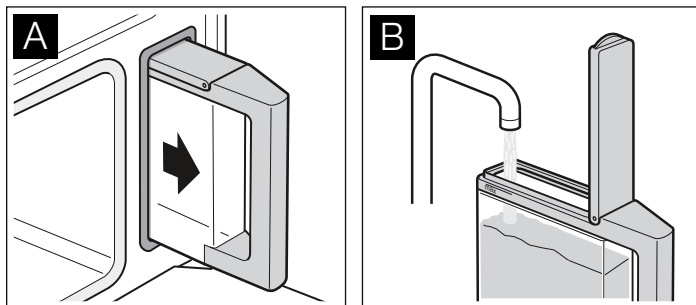

3. Close tank lid until it snaps.
4. Insert water tank completely (picture C).

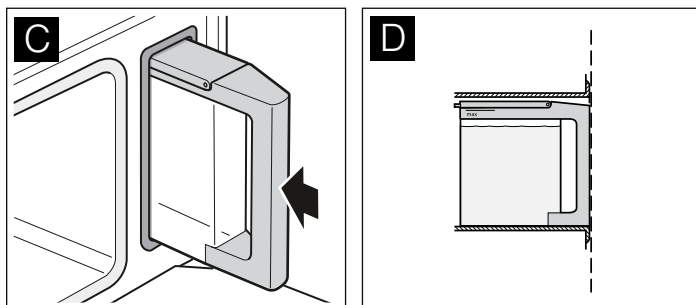

The tank must be flush with the tank funnel (picture D).

After each use

Empty the water tank after each use.

1. Keep the water tank level while slowly pulling it out of the appliance to ensure that no remaining water drips down and out through the vent.
2. Pour out the water.
3. Thoroughly dry the seal of the tank lid and the slot where the tank resides in the appliance.

Indication of water level

The indicator lights up:

The water tank is only half full.

If you think that the amount of water in the water tank is sufficient for what you want to cook, you can start the appliance. If the water level is too low, then fill the water tank up to "max", slide the tank back in and then start the appliance.

The indicator starts flashing:

The water tank is empty. A beep sound and operation is stopped.

1. Carefully open the oven door. Steam will escape from inside.
2. Remove the water tank, fill it and slide it back in.
3. Press **START/STOP**.

Automatic Calibration

The temperature at which the water will boil depends on the air pressure. During calibration, the appliance is adjusted to the pressure conditions in the area where it has been installed. This takes place automatically the first time steam is used at 210 °F (100° C). More steam than usual will be produced during calibration.

After moving: To ensure that the appliance will automatically adjust to the new location, reset the appliance to its factory settings (see *Basic Settings*)

Operating the Appliance

This section covers the following:

- Turning the appliance on and off
- Important instructions to follow after each use.

WARNING

SCALDING HAZARD

Movement when opening the appliance door and when removing the cookware can cause hot liquid to spray out. Do not stand too close to the appliance when opening it. Open appliance door carefully. Remove cookware carefully. Keep children away.

Turning on the Appliance

Example shown in the illustration:

Set the oven mode to Steam at 175 °F (80° C).

1. Touch and hold ON/OFF until the appliance turns on. OVEN MODE lights up in the display. The first oven mode, True Convection  appears in the display.



2. Use the settings dial to set the desired oven mode.

3. Touch OVEN TEMP and use the settings dial to set the temperature.



4. Touch TIMER/CLOCK repeatedly until the arrow appears after the I→◀ Cook Time symbol.
5. Use the settings dial to set the Cook Time (see *Clock and Timer Settings*).
6. Press START/STOP to turn on the appliance. The appliance starts to heat up. When using Steam mode, the Cook Time starts after the appliance is preheated.

Changing the temperature

After Cook Time starts, you can turn the settings dial at any time to change the temperature.

Changing the End Time

See *Clock and Timer Settings, Changing the End Time*.

Turning Off the Appliance

▲ WARNING

RISK OF SEVERE BURNS

Hot steam may escape when opening the appliance door. Carefully open the door only after cooking is finished.

At the end of Cook Time

If you set a cook time, the appliance will turn off automatically. A beep sounds. Press TIMER/CLOCK to stop the signal.

Touch and hold ON/OFF until the appliance turns off. Carefully open the appliance door.

Pausing Operation

Touch START/STOP or open the appliance door. The appliance pauses operation. START/STOP flashes.

Close the appliance door and press START/STOP to resume operation.

If you have activated Autostart, the appliance will not resume operation (see *Basic Settings*).

Canceling Operation

Touch and hold ON/OFF to cancel operation and turn off the appliance.

The cooling fan may continue to run when you open the appliance door.

After every use

Empty water tank

1. Open the appliance door carefully. Hot steam can escape!
2. Remove and empty water tank.
3. Dry the tank lid and tank duct in the appliance well.

NOTICE: Do not dry the water tank in the hot oven. This will damage the water tank.

Dry oven

▲ WARNING

RISK OF SCALDING

The water in the evaporator shell can be hot. Let it cool before wiping it out.

1. Leave the appliance door open a crack until the appliance has cooled.
2. Wipe out the cooled oven and evaporator shell with the accompanying sponge and dry it off well with a soft cloth.
3. Remove dirt from the oven immediately after the appliance has cooled. Burnt on food is much harder to remove later.
4. Wipe down furniture or handles in case condensation has accumulated there.

Automatic Shutoff

The appliance features an automatic shutoff function. Automatic shutoff is activated when the settings have not been changed over an extended period of time. The time when automatic shutoff is activated is based on the temperature selected.

Shutoff Activated



FB appears in the display. Operation is interrupted.

Touch any key to make the display indicator disappear. You can now adjust the settings.





Clock and Timer Settings

Use TIMER/CLOCK to access the clock and timer settings. The following options are available.

If the appliance is off

-  sets the timer
-  sets the clock

If the appliance is on

-  sets the timer
-  sets the Cook Time, if applicable
-  changes the End Time, if applicable
-  displays the time

A short beep will sound when you are not permitted to change or adjust a setting.

Setting the Timer

The timer works independently from other functions of the appliance. It can be used as a kitchen timer and can be set at any time.

1. Touch TIMER/CLOCK.

The arrow appears after the Timer symbol .

2. Use the settings dial to set the timer.

The timer is set for "minutes:seconds".

The timer runs on the display for a few seconds. It then moves to the background. The  symbol indicates that the timer is running.

Display the running timer

Touch TIMER/CLOCK. The timer appears for a few seconds.

Changing the timer

Touch TIMER/CLOCK. Use the settings dial to change the timer.

Canceling the timer

Touch TIMER/CLOCK and turn the settings dial to reset the timer to 00:00. The timer disappears after a few seconds.

After the timer runs out

A beep sounds. 00:00  appears on the display. Touch TIMER/CLOCK to cancel the signal.

Setting the Cook Time

If you set Cook Time for your dish, operation automatically stops at the end of the programmed time. The appliance stops heating.

Note: Cook Time must always be set when using oven modes with steam.

Example shown in the illustration:

Set Cook Time to 35 minutes.

Requirement:

An oven mode and temperature must be set.

1. Touch TIMER/CLOCK repeatedly until the arrow appears after the  Cook Time symbol.



2. Use the settings dial to set the Cook Time.

The Cook Time is accepted after a few seconds. The parentheses to the left and right of the Cook Time disappear. The  symbol lights up.

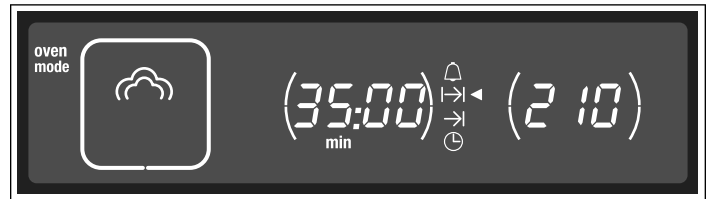

3. If operation has not yet started, touch START/STOP. The running Cook Time is visible in the display.

Note: When using Steam mode, the Cook Time starts after the appliance is preheated.

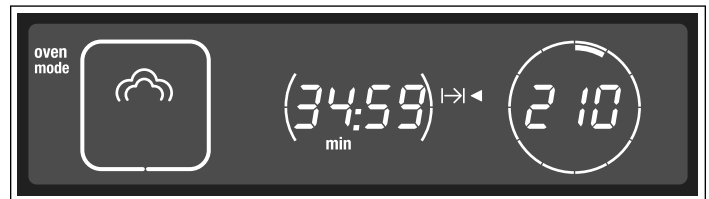

After the Cook Time runs out

A beep sounds. The appliance stops heating. Touch TIMER/CLOCK to stop the signal early.

CAUTION

Hot steam can escape when opening the oven door.

Open the oven door and use potholders to carefully remove ovenware. Touch and hold ON/OFF until the appliance turns off.

Changing the Cook Time

Touch TIMER/CLOCK repeatedly until the arrow appears after the  Cook Time symbol. Use the settings dial to change the Cook Time. The changed Cook Time starts.

Checking the Time Settings

Use TIMER/CLOCK to check all settings.

Changing the End Time

You can change the time when the food will be done. The appliance starts automatically and turns off at the preferred End Time.

⚠ CAUTION

To maintain food safety, do not leave food in the oven for more than one hour before or after cooking.

Note: Some programs do not allow the End Time to be changed.

The time required for preheating when using Steam must be considered when setting the Cook Time. The set End Time can be delayed to make up for the time required for preheating.

Delaying the End Time

The example is shown in the illustrations:

It is 9:30 a.m. The food takes 45 minutes to cook, but should not be ready until 12:45 p.m.

Requirements:

- The set mode has not started.
- A Cook Time has been set.

1. Touch TIMER/CLOCK repeatedly until the arrow appears after the End Time symbol →|◀.

The bars in the display indicate that the End Time has not been changed.

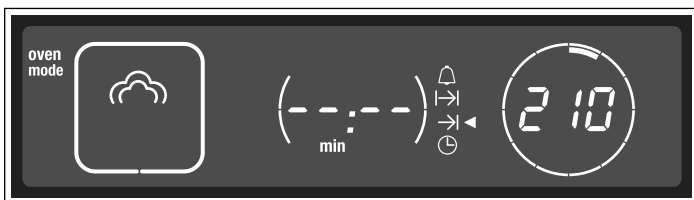

2. Use the settings dial to set the End Time to a later time.

3. Touch START/STOP to confirm.

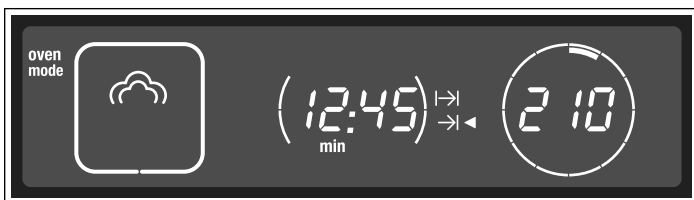

The setting is accepted. The appliance is in delayed mode. The End Time →|◀ is displayed.

Operation starts automatically at the correct time. In the example, operation starts at 12:00 p.m. The running Cook Time |→|◀ then appears in the display.

Adjusting the End Time

The End Time can be adjusted as long as the appliance is in delayed mode. To do this, use TIMER/CLOCK to switch to End Time →|◀ and use the settings dial to adjust the End Time.

Canceling the End Time

The End Time can be canceled as long as the appliance is in delayed mode. To do this, use TIMER/CLOCK to switch to End Time →|◀ and turn the settings dial to the left until -:- appears. Cook Time starts immediately.

After the Cook Time runs out

A beep sounds. The appliance stops heating. Touch TIMER/CLOCK to stop the signal early.

⚠ CAUTION

Hot steam can escape when opening the oven door.

Open the oven door and use potholders to carefully remove ovenware. Touch and hold ON/OFF until the appliance turns off.

Setting the Clock

The appliance must be off in order to set or change the clock.

After a Power Outage

After a power outage, four zeros flash in the display.

1. Use the settings dial to set the current time.
2. Touch TIMER/CLOCK. The clock setting is accepted.

Changing the Time

Example:

Switching daylight savings on or off on the clock.

1. Touch TIMER/CLOCK repeatedly until the arrow appears after the Clock symbol ⌚◀.
2. Use the settings dial to change the time.
3. Touch TIMER/CLOCK. The new clock setting is accepted.

Changing the Time Format

The clock can display the time in 12-hour or 24-hour format (see *Basic Settings*).

Displaying the Time

When the appliance is off, the current time is not displayed. You can change this setting, so that the time is also displayed when the appliance is off (see *Basic Settings*).

Automatic Programming - EasyCook

This section covers the following:

- Setting a program from automatic programming - EasyCook
- Information and tips on the programs
- Available programs

Automatic programming makes it easy to prepare food. There are 16 program groups with a total of 40 programs.

⚠ CAUTION

To maintain food safety, do not leave food in the oven for more than one hour before or after cooking.

Setting a Program

Select the appropriate program from the program chart. Read the information on the programs.

The example is shown in the illustration: To roast 3 lbs (1.4 kg) of fresh chicken (program P13):

1. Touch and hold ON/OFF until the appliance turns on.
2. Touch EASY COOK.
The first program **P01** and a suggested weight appear in the display.

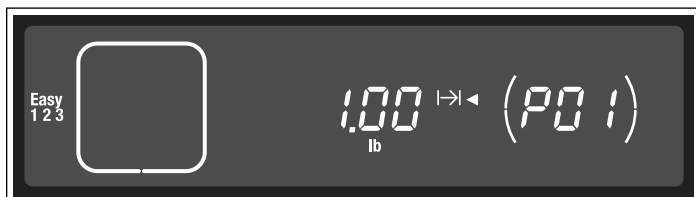

3. Use the settings dial to select the preferred program.

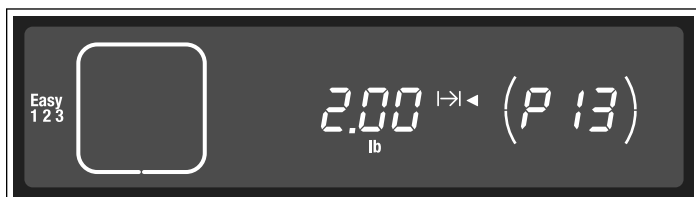

4. Touch WEIGHT and use the settings dial to set the weight of the food.

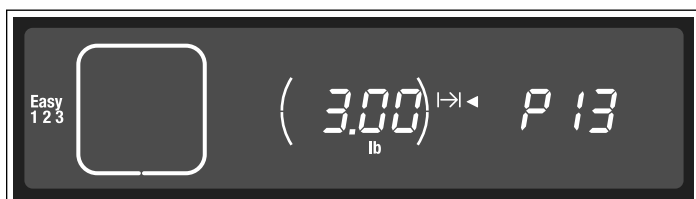

5. Touch START/STOP to start the appliance.

The running Cook Time of the program **62:02** appears in the display.

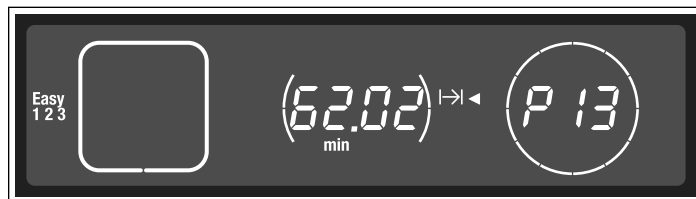

⚠ WARNING

RISK OF SEVERE BURNS

Hot steam may escape when opening the appliance door. Carefully open the door only after cooking is finished.

Changing End Time

Some programs allow you to delay the End Time. The program starts later and ends at the preferred time (see section: *Clock and Timer Settings*).

Clearing Settings

To clear all settings, touch and hold START/STOP for four seconds. You can now set a new oven mode or a new program.

At the End of Cook Time

A beep sounds. Touch TIMER/CLOCK to stop the signal early.

Open the oven door and use pot holders to carefully remove ovenware. Touch and hold ON/OFF until the appliance turns off.

Canceling a Program

Touch and hold ON/OFF to cancel operation and turn off the appliance.

Program Information

All programs are designed for cooking on one level. Cooking results may vary depending on the amount and quality of the food.

Ovenware

Use the recommended ovenware. All meals have been tested using this ovenware. Cooking results may vary if different ovenware is used.

When cooking food in a perforated cooking pan, also insert the baking pan at rack level 1. The pan will catch any drippings.

Quantity/Weight

Add liquid and food mixtures such as rice and water no more than 1.6 inches up the side of the accessory.

Automatic programming requires the weight of the food. For individual pieces, like pieces of chicken, always enter the weight of the largest piece. The total weight must be within the present weight range.

Cooking Time

The cooking time appears after the program starts. You can change it during the first 10 minutes, since the preheat time depends on conditions such as the temperature of the water and of the food being cooked.

Vegetables

Wait until after cooking to season vegetables.

Program	Notes	Ovenware/accessories	Level
P1*	Steam cauliflower florets	Florets of equal size	Perforated cooking pan + 3 baking pan 1
P2*	Steam green beans	-	Perforated cooking pan + 3 baking pan 1
P3*	Steam broccoli florets	Florets of equal size	Perforated cooking pan + 3 baking pan 1
P4*	Steam green asparagus	-	Perforated cooking pan + 3 baking pan 1
P5**	Steam mixed vegetables, frozen	-	Perforated cooking pan + 3 baking pan 1

* You can delay the End Time for this program

** Can be used with all frozen vegetables

Potatoes

Wait until after cooking to season potatoes.

Program	Notes	Ovenware/accessories	Level
P6*	Unpeeled boiled potatoes	Medium-size, 1.6-2" diam.	Perforated cooking pan + 3 baking pan 1
P7*	Boiled potatoes	Medium-sized, quartered, individual weight, 1-1.4 oz (30-40 g)	Perforated cooking pan + 3 baking pan 1

* You can delay the End Time for this program

Cereals and grains

Weigh out the food to be cooked and add the correct amount of water:

Rice 1 : 1.5

Couscous 1 : 1

Enter the dry weight. One cup of rice equals 0.4 lbs.

Stir the cereal or grain after cooking. This will help it quickly absorb the remaining water.

To prepare risotto: Add water to the risotto at a ratio of 1 to 2. Enter the entire weight, including the water. One cup of risotto and 2 cups of water equal approximately 1.5 lbs. The message "stir" will appear after approximately 15 minutes. Stir the risotto.

Program	Notes	Ovenware/accessories	Level
P8	Basmati rice	max. 1.7 lbs. (0.75 kg)	Cooking pan 2
P9	Brown rice	max. 1.7 lbs. (0.75 kg)	Cooking pan 2
P10	Long grain rice	max. 1.7 lbs. (0.75 kg)	Cooking pan 2
P11	Couscous	max. 1.7 lbs. (0.75 kg)	Cooking pan 2
P12	Risotto, Arborio rice	max. 4.5 lbs. (2 kg)	Cooking pan 2

Poultry

Do not place pieces of chicken on top of each other in the ovenware. You can marinate the pieces of chicken before cooking.

Program	Notes	Ovenware/accessories	Level
P13 Whole chicken, fresh	Total weight 1.5 - 4.5 lbs. (0.7 - 1.5 kg)	Wire rack + baking pan	2
P14 Chicken parts	Total weight 0.3 - 1.2 lbs. (0.04 - 0.35 kg)	Wire rack + baking pan	2

Beef

A tall roast is recommended for roast beef.

Program	Notes	Ovenware/accessories	Level
P15** Sirloin, fresh, slow cook, medium	Total weight 2 - 4.5 lbs. (1 - 2 kg)	Baking pan	2
P16* Pot roast (chuck), fresh	1 - 3.5 lbs. (1 - 1.5 kg)	Baking pan	2

* You can delay the End Time for this program

** Sear the meat before cooking

Pork

Cut the rind from the center outward prior to cooking.
The shoulder cut is the best cut for a roast with crust.

Program	Notes	Ovenware/accessories	Level
P17* Roast, fresh	2 - 4.5 lbs. (0.8 - 2 kg)	Wire rack + baking pan	2

* You can delay the End Time for this program

Lamb

Program	Notes	Ovenware/accessories	Level
P18 Leg, fresh, boned, well done	2 - 4.5 lbs. (1 - 2 kg)	Wire rack + baking pan	2
P19* Leg, fresh, boned, slow cook, medium*	2 - 4.5 lbs. (1 - 2 kg)	Baking pan	2

* Sear the meat well beforehand

Fish

Grease the perforated cooking pan to prepare for the fish.

Do not place whole fish, fish fillets or fish sticks on top of each other. Enter the weight of the heaviest piece of fish and select pieces that are approximately the same size.

Program	Notes	Ovenware/accessories	Level
P20 Steaming whole fresh fish	0.5 - 4.5 lbs. (0.3 - 2 kg)	Perforated cooking pan + baking pan	3 1
P21 Steaming fish fillets, fresh	max. 1" thick	Perforated cooking pan + baking pan	3 1
P22 Steaming fish fillet, frozen	max. 1" thick	Perforated cooking pan + baking pan	3 1
P23 Oysters and clams	-	Perforated cooking pan + baking pan	2

Baked goods, desserts

Preparing fruit compote: This program is suitable for fruits with stones and pits only. Weigh out the fruit, add approximately $\frac{1}{3}$ of water and add sugar and spices to taste.

Preparing rice pudding: Weigh out the rice and add 2.5 times as much milk. Add the rice and milk no more than 1 inch up the side of the accessory. Stir after cooking. The remaining milk will be absorbed quickly.

Program	Notes	Ovenware/accessories	Level	
P24*	Fruit compote	-	Baking pan	2
P25	Rice pudding	-	Baking pan	2

* You can delay the End Time for this program

Bread, bread rolls

Use parchment paper on the baking pan when baking bread and bread rolls.

Baking bread: The programs are for free-form loaves only. Baking bread in a loaf pan is not recommended. The dough should not be too soft. Before baking, use a sharp knife to make several slashes about 0.4 inches deep into the bread dough..

Let the dough rise and then bake. A beep will sound after approximately 20 minutes. Make slash marks in the dough and then touch START/STOP.

Baking fresh bread rolls: The rolls should all weigh the same. Enter the weight of the individual bread rolls.

Program	Notes	Ovenware/accessories	Level	
P26*	White bread, bake	1 - 4.5 lbs. (0.4 - 2 kg)	Baking pan + parchment paper	2
P27	White bread, proof and bake	Note the message	Baking pan + parchment paper	2
P28*	Multigrain bread, bake	1.25 - 4.5 lbs. (0.6 - 2 kg)	Baking pan + parchment paper	2
P29	Multigrain bread, proof and bake	Note the message	Baking pan + parchment paper	2
P30*	Rye bread, bake	1.25 - 4.5 lbs. (0.6 - 2 kg)	Baking pan + parchment paper	2
P31	Rye bread, proof and bake	Note the message	Baking pan + parchment paper	2
P32*	Fresh bread rolls, bake	Weight per piece 0.1 - 0.3 lbs. (0.05 - 0.1 kg)	Baking pan + parchment paper	2
P33	Frozen bread rolls, bake	Total weight 0.5 - 2.5 lbs. (0.2 - 1 kg)	Baking pan + parchment paper	2

* You can delay the End Time for this program

Reheat

Program	Notes	Ovenware/accessories	Level	
P34*	Pizza, cooked, thin crust	-	Wire rack + baking pan	3
P35*	Pizza, cooked, deep dish	-	Wire rack + baking pan	3

* You can delay the End Time for this program

Defrosting

- Freeze the food as flat as possible and in appropriate portions at -0° F (-18°C).
- Do not freeze oversized portions. Defrosted food does not keep as long and spoils more quickly than fresh food.
- All defrost programs assume the food is raw.
- If necessary, while the food is thawing, split it up or take pieces that have already thawed out of the appliance.
- Let the food sit for another 5 to 15 minutes after it has thawed to complete defrosting.

▲ WARNING

HEALTH HAZARD

When defrosting animal food products, make sure to remove the thawed liquid. The liquid must not come into contact with other food products. Germs could be transferred to the other food. After the food has thawed, heat up the steamer oven using True Convection for 15 minutes at 360° F (180°C).

- **Defrost whole bird:** Remove the packaging before defrosting. Let the bird sit for some time after it has thawed. For large chickens, you can remove the giblets after resting for approximately 30 minutes.
- **Defrost meat:** Use this program to defrost individual cuts of roast.
- **Thaw fruit only:** If you want to thaw fruit slightly, adjust the cooking results based on the individual fruit.

Program	Notes	Ovenware/accessories	Level	
P36	Chicken pieces, bone-in	max. 4.5 lbs. (1.8 kg)	Perforated cooking pan + baking pan	3 1
P37	Meat	max. weight 3.5 lbs. (1.5 kg) per piece	Perforated cooking pan + baking pan	3 1
P38	Berries	-	Perforated cooking pan + baking pan	3 1

Cooking eggs

Pierce holes in eggs before cooking. If eggs are not pierced, they may burst during cooking. Do not place

eggs on top of each other. One large egg weighs approx. 2 oz. (57 g).

Program	Notes	Ovenware/accessories	Level	
P39*	Soft-boiled eggs	Eggs, large, max. 2 lbs. (1 kg)	Perforated cooking pan + baking pan	3 1
P40*	Hard-boiled eggs	Eggs, large, max. 4 lbs. (1.8 kg)	Perforated cooking pan + baking pan	3 1

* You can delay the End Time for this program

Favorites

Use FAVORITES to store and access 6 custom programs at any time. FAVORITES is useful if you frequently prepare particular types of meals. You can also store a meal from automatic programming.

Storing a Setting in Favorites

1. Set the preferred mode. Do not start the oven.
2. Briefly touch FAVORITES and use the settings dial to select the memory setting.



3. Touch and hold FAVORITES until the ✓ symbol appears after the memory setting.
The setting is stored and can be started at any time.

Storing a Different Setting

Enter a new setting and store it. This will override the old setting.

Canceling a FAVORITES Setting

Touch and hold START/STOP.

Starting a FAVORITES Setting

You can start stored settings at any time.

1. Briefly touch FAVORITES and use the settings dial to select the memory setting. The stored settings are displayed.
2. Touch START/STOP.
The FAVORITES setting starts.

Changing the Memory Setting

Once a setting is started, you cannot change it.

Canceling a running FAVORITES Setting

Touch and hold START/STOP until True Convection mode (☼) appears. You can now adjust the settings.

Deleting a FAVORITES Setting

If you change the basic setting C01, C09, C10 or C11, all FAVORITES settings are cleared (see: *Basic Settings*).

Panel Lock

You can use the panel lock to prevent children from accidentally turning the appliance on.

Activate Panel Lock

Turn off the appliance. Touch and hold PANEL LOCK for approximately four seconds until the →○ symbol appears.

The Panel Lock is activated.

Deactivate Panel Lock

Touch PANEL LOCK until the →○ symbol disappears.

The Panel Lock is deactivated.

Note: You can still set the timer while the panel lock is activated.

Basic Settings

The appliance features various basic settings present in the factory. These basic settings can, however, be changed as necessary.

You can restore the factory settings to reverse any changes.

The example is shown in the illustration:

Change the basic setting for the Cook Time signal from short to long.

1. Touch and hold ON/OFF until the appliance turns on.
2. Touch and hold INFO for approximately 4 seconds.
The first basic setting C01 appears in the display.



3. Touch INFO repeatedly until the desired basic setting appears.
4. Use the settings dial to change the basic setting.



Now you can touch INFO to select additional basic settings and change them using the settings dial.

5. Touch and hold INFO for approximately 4 seconds. All changes have been saved.

Canceling Changes

Touch START/STOP. The changes are not saved.

Basic Settings Table

The following basic settings can be changed:

Basic Setting	Function	Options
C01* National code	Preselection of units and clock display mode: USA - °F, 12-hour mode, lbs. Canada - °C, 24-hour mode, kg	0 = none 1 = USA 2 = Canada
C02 Clock display	When the appliance is off	0 = off 1 = on
C03 Time	Sets current time	
C04 Touchpad sound	Sound emitted when a touchpad is touched	0 = off 1 = on
C05 Cook Time signal	Signal after Cook Timer ends	1 = short 2 = medium 3 = long
C06 Oven Autostart	Autostart activated: Oven does not restart after oven door is opened	0 = off 1 = on
C07 Water hardness level	Water hardness level setting for the Decalcify indicator	- = softened 1 = soft 2 = average 3 = hard 4 = very hard
C08 Calibration	Resets calibration. The appliance is recalibrated the next time Steam mode is used at 210° F (100 °C).	OFF = reset off On = reset on
C09* Temperature units	Temperatures are indicated in °F. If you switch to °C, "°C" also appears in the display.	0 = °F 1 = °C
C10* Clock display mode	The clock in the display appears in 12-hour or 24-hour mode	0 = 12-hour mode 1 = 24-hour mode
C11* Weight units	Weights can be displayed in lbs. or kg.	0 = lbs. 1 = kg
C12 Display brightness	Sets the display brightness.	8 levels: 0 (dark) - 7 (bright)

* If you change the basic settings, all Favorites settings are cleared (see: *Favorites*).

Cleaning and Maintenance

Cleaning

This section covers information on the following:

- Care and cleaning of the appliance
- Cleaning agents and aids
- Steam Clean mode
- Decalcify mode

▲ WARNING

RISK OF SHORT CIRCUITING

Never use pressure washers or steam jet blowers to clean the appliance.

▲ WARNING

RISK OF BURNS

Wait until the appliance has cooled down before cleaning.

NOTICE:

- Remove food residue and spills from the cavity immediately after the appliance has cooled down. Burned on residue is very difficult to remove at a later time.
- If heavily soiled, use Steam Clean mode (see *Steam Clean*).
- Salts are very abrasive and can cause rust spots. Remove residue left by strong sauces (ketchup, mustard) or salted foods immediately after the oven has cooled down.

Cleaning Sponge

The cleaning sponge provided is very absorbent. Use the cleaning sponge only to clean the oven cavity and to remove any remaining water from the evaporator dish. Wash the cleaning sponge thoroughly before initial use. The cleaning sponge can be washed in a dishwasher.

Cleaners

Appliance exterior	Soapy water, Use a soft cloth to dry.
aluminum front panel/handle	Mild window cleaner. Wipe using a soft window cloth or a lint-free microfiber cloth at a horizontal angle without placing pressure on the surfaces.
stainless steel front trim, door handle	Soapy water, Use a soft cloth to dry. Always remove lime deposits, grease, oil, starch and egg white stains immediately. Special stainless steel cleaners are available through customer service or at retail stores.
Oven interior	Warm soapy water or vinegar and water mixture. Use the cleaning sponge provided or a soft dishwashing brush. NOTICE: Never use steelwool or abrasive pads! The oven cavity can rust. If heavily soiled, use an all-purpose cleaner, such as Simple Green. Follow package directions for mixing. Spray on soils, allow to work for 15 - 30 minutes, then wipe the entire cavity with paper towels or cloth. Run Steam Clean cycle so the cavity is rinsed thoroughly. NOTICE: Do not allow the oven light, bulb or door gaskets to come in contact with the cleaner.
Evaporator dish	Warm soapy water or vinegar and water mixture.
Outer gasket on oven	Warm soapy water.
Water tank	Soapy water. Do not clean in dishwasher!
Tank slot	Wipe dry after each use.
Lid seal	Dry well after each use.
Rack rails	Use warm soapy water or wash in dishwasher (see <i>Cleaning Racks</i>).
Glass in doors	Glass cleaner
Accessories	Soak in warm soapy water. Clean with a brush or kitchen sponge or wash in dishwasher. Use a water and vinegar mixture for stains or discoloration caused by starchy foods (such as rice).

Steam Clean

Steam Clean uses steam to help dissolve food residue and spills in the oven. Residue and spills can be easily removed afterward.

Steam Clean takes approximately 30 minutes.

Note: Operation of the appliance will be blocked if Steam Clean is canceled. The appliance cannot be operated again until after the first and second cleaning cycle to ensure that no dishwashing liquid remains inside.

Preparation

- Let the oven cool down and remove any accessories.
- Clean the evaporator dish using the cleaning sponge provided.
- Fill the water tank with water up to "max". Add a drop of dishwashing liquid to the evaporator dish on the oven bottom.

Starting Steam Clean

1. Touch and hold ON/OFF until the appliance turns on.
2. Touch STEAM CLEAN to select Steam Clean mode.
3. Touch START/STOP. Steam Clean starts. The light in the oven remains off.

Cleaning Cycle 1

A beep sounds after approximately 30 minutes. The  (empty evaporator dish) symbol appears.

1. Remove the rack rails from the oven and clean (see *Removing Rack Rails*).
2. Use a soft dishwashing brush and the cleaning sponge to wipe out the partially dissolved food soil from the oven and evaporator dish.
3. Fill the water tank with water, if necessary, and then slide it back in.
4. Touch START/STOP. The appliance starts the cleaning process.

Cleaning Cycle 2

After a short time, the  symbol appears for the second time.

1. Thoroughly wash out the cleaning sponge.
2. Use the cleaning sponge to remove any water remaining in the evaporator dish.
3. Touch START/STOP.
The appliance starts the cleaning process. After the second cleaning cycle, the  symbol appears.
4. Touch and hold ON/OFF.

Removing Residual Water

Use the cleaning sponge to remove any water remaining in the evaporator dish. Wipe down the oven using the cleaning sponge and dry afterwards using a soft cloth.

Canceling Steam Clean

1. Touch and hold ON/OFF. Steam Clean stops.
The appliance must be cleaned twice after Steam Clean is canceled to ensure that no dishwashing soap remains inside.
2. Touch ON/OFF. The  symbol appears.
Now follow the same steps as under *Cleaning Cycle 1* described above.

Decalcify

Run Decalcify mode at specific intervals to ensure that the appliance continues to operate properly. The  indicator will remind you.

The descaling process takes approximately 30 minutes. Decalcify mode is not required if you only use softened water.

Note: Operation of the appliance will be blocked if Decalcify is canceled. The appliance cannot be operated again until after the first and second cleaning cycle to ensure that not descaling agent remains inside.

Descaling Agent

Use only the powder descaler recommended by customer service to descale the appliance.

USA:

www.thermador-eshop.com

Canada :

Marcone - 800 - 287 - 1627

or Reliable Parts - 800-663-6060, www.reliableparts.ca

NOTICE: Other descaling agents can damage the appliance.

1. Mix 32 oz water and 1 packet powder descaler to produce a descaler solution.
2. Empty the water tank and fill it with the descaling solution.

NOTICE: Do not let the descaling solution come in contact with the control panel or other sensitive surfaces. If it does, immediately remove it using water.

Starting Decalcify Mode

The oven cavity must be cooled down completely.

1. Touch and hold ON/OFF until the appliance turns on.
2. Touch DECALCIFY to select Decalcify mode.
3. Touch START/STOP. Decalcify mode starts. The light in the oven remains off.

Cleaning Cycle 1

A beep sounds after approximately 30 minutes. The  (fill water tank) symbol appears.

1. Wash out the water tank thoroughly, fill it with water and slide it back in. the  (empty evaporator dish) symbol appears.
2. Use the cleaning sponge provided to remove any water remaining in the evaporator dish.
3. Touch START/STOP. The appliance starts the cleaning process.

Cleaning Cycle 2

After a short time, the  symbol appears for the second time.

1. Thoroughly wash out the cleaning sponge.
2. Use the cleaning sponge to remove any water remaining in the evaporator dish.
3. Touch START/STOP. The appliance starts the cleaning process. After Decalcify mode is complete,  appears.
4. Touch and hold ON/OFF.

Removing Residual Water

Use the cleaning sponge to remove any water remaining in the evaporator dish. Wipe down the oven using the cleaning sponge and dry afterwards using a soft cloth.

Canceling Decalcify Mode

1. Touch and hold ON/OFF. Decalcify mode stops. The appliance must be cleaned twice after Decalcify mode is canceled to ensure that no descaling solution remains inside.
2. Touch ON/OFF. The  symbol appears. Now follow the same steps as under *Cleaning Cycle 1* described above.

Descaling Only the Evaporator Dish

You can also use Decalcify mode to descale only the evaporator dish in the oven cavity without descaling the entire appliance.

The only difference in this procedure is as follows:

1. Mix 1½ cups of water and 2 teaspoons powder descaler to produce a descaler solution.
2. Fill the evaporator dish completely with the descaling solution.
3. Fill the water tank with water only.
4. Start Decalcify mode as described.

You can also descale the evaporator dish manually.

Removing and Installing the Appliance Door

The appliance door can be removed for easy cleaning.

⚠ CAUTION

WHEN REMOVING THE OVEN DOOR:

- Make sure oven is cool and power to the oven has been turned off before removing the door. Failure to do so could result in electrical shock or burns.
- The oven door is heavy and parts of it are fragile. Use both hands to remove the oven door. The door front includes glass components. Handle carefully to avoid breakage.
- Grasp only the sides of the oven door. Do not grasp the handle as it may swing in your hand and cause damage or injury.
- Failure to grasp the oven door firmly and properly could result in personal injury or product damage.
- To avoid injury from hinge bracket snapping closed, be sure that both locking levers are securely in place before removing the door. Also, do not force the oven door open or closed - the hinge could be damaged and injury could result.
- If the door is removed without turning both retainers until they stop, the hinge can snap back. Do not reach into the hinge area. Call customer service.
- Do not lay the removed door on sharp or pointed objects as this could break the glass. Lay the door on a flat, smooth surface, positioned so that the door cannot fall over.

Removing the Appliance Door

1. Open the door all the way.
2. Lay the two stop levers on the right and left down flat (picture A).
3. Position the door at an angle. Use both hands to grasp the left and right sides of the door. Close the door a little more and then remove it (picture B).

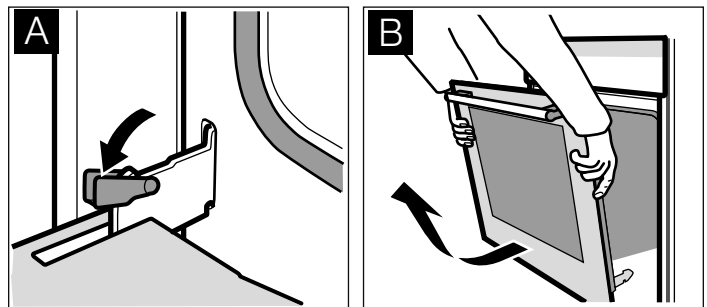

Installing the Appliance Door

Reattach the door after cleaning.

1. Keep the door hinges straight while inserting them into the left and right oven openings. The notch on both hinges must lock in place on both sides (picture C).

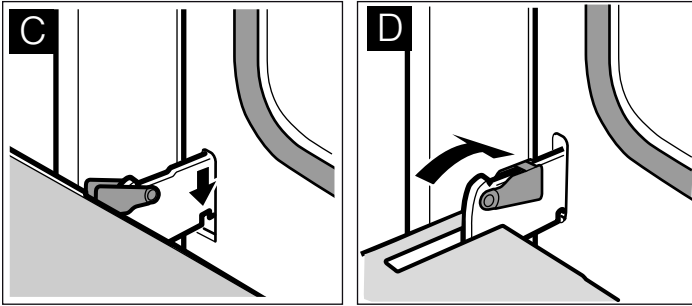

2. Open the door all the way and flip up the stop lever (picture C).
3. Close the door.

Cleaning the Door Glass

The inner door glass on the appliance can be removed for easier cleaning.

⚠ WARNING

RISK OF PERSONAL INJURY

- Do not use the appliance until the door glass and appliance door have been properly installed.
- Hidden parts at the appliance door could have sharp edges. Use protective gloves!

1. Remove the door and place it on a towel, handle side down.
2. Unscrew the top cover on the door. To do this, loosen the left and right screws (Fig. A).
3. Remove the door glass (Fig. B).

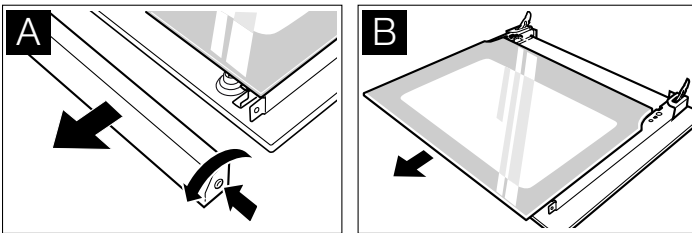

Clean the door glass using a glass cleaner and a soft cloth.

Removing the intermediate panel

Before removing, make a note of the position in which the intermediate panel is fitted, so that you do not refit it the wrong way round later.

1. Press the left and right-hand holders outwards.
2. Lift the intermediate panel slightly and take it out.

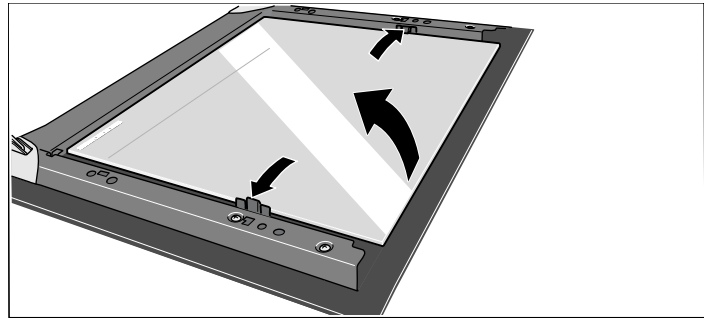

Cleaning

Clean the door glass using a glass cleaner and a soft cloth.

NOTICE: Do not use any sharp or abrasive medium or a glass scraper. The glass could be damaged.

Fitting the intermediate panel

1. Insert the intermediate panel on the left and right into the supports.
2. Push the intermediate panel downwards in the retainers.

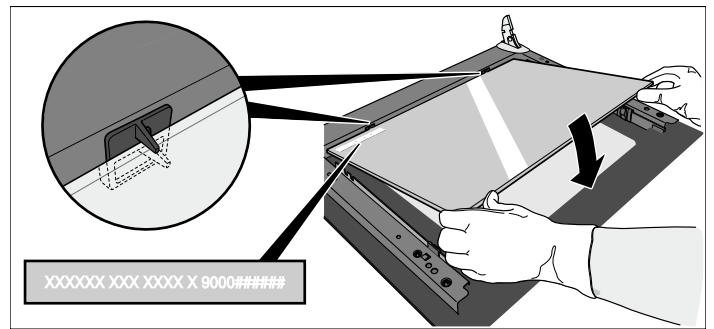

Installing the Door Glass

1. Reinsert the door glass.
Make sure that the flat surface faces outward and the printed surface is on the inside.
2. Put the cover in place and screw it back on.
3. Reinstall the door.

Clean racks

The racks can be removed for cleaning.

▲ WARNING

RISK OF BURNS FROM HOT PARTS WITHIN THE OVEN

Wait until the oven is cool.

Unhinging racks

NOTICE: Tilt the rack all the way to the front only until you feel resistance because otherwise the appliance sidewall will be bent.

1. Carefully press the front of the rack up until it unhinges and release it sideways from the bracket (image A).
2. Unhinge the rack from the bracket and remove it (image B).

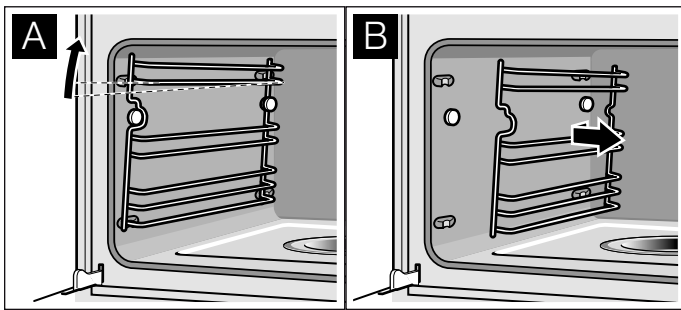

3. Clean racks with dish detergent and dish sponge/brush or clean racks in the dish washer.

Reinserting racks

1. Insert the rack with the indentations facing up.
2. Hook rack in back and push it back until it engages (image C).
3. Hook rack on the front bracket and press down until it engages and is horizontally secured in the appliance (image D).

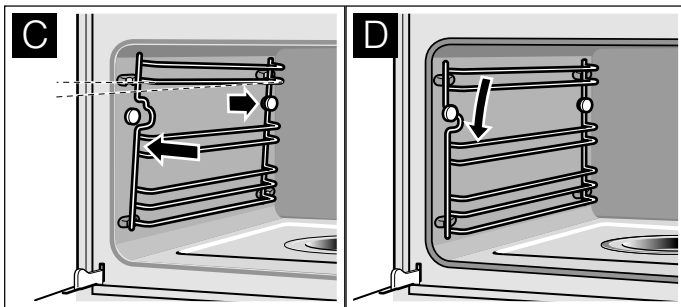

The racks each only fit on one side.

Replacing the Door Gasket

If the outer gasket on the oven door is defective, it must be replaced. Replacement gaskets for the appliance can be obtained through customer service. Provide customer service with the appliance model and serial numbers.

1. Open the appliance door.
2. Remove the old door gasket.
3. Insert the new door gasket and tuck it in all the way around the door. The seam must be on the side of the door.
4. Check the fit of the door gasket again, particularly in the corners.

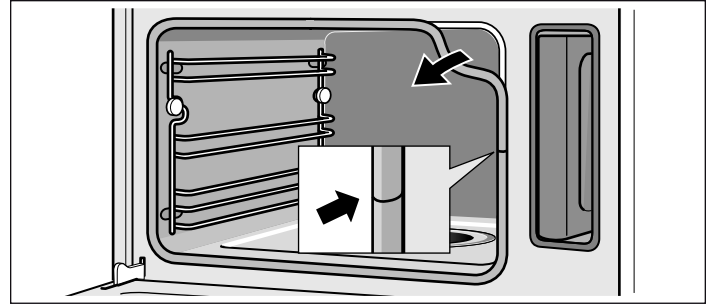





Service

Before Calling for Service

Before calling Customer Service, consider the suggestions and instructions below:

⚠ CAUTION

Repairs should only be done by an authorized servicer.
Improper repair of your appliance may result in risk of severe physical injury or death.

Problem	Possible Cause	Tip/Solution
Appliance is not working	Cord is not plugged in	Connect appliance to power.
	Power outage	Check if other kitchen appliances are working.
	Defective fuse	Check the fuse or breaker box to see if the breaker or fuse to the appliance is working.
	Faulty operation	Turn off power to the appliance at the main power supply (fuse or breaker box) and turn it back on after approximately 10 seconds.
Appliance does not start	Appliance door is not closed all the way	Close the appliance door.
Appliance does not start, 00:40 min. appears and  flashes in the display	Steam Clean or Decalcify was canceled	Clean the appliance twice (see <i>Canceling Steam Clean</i> or <i>Canceling Decalcify Mode</i>).
Four zeros appear in the display 00:00	Power outage	Set the current time using the settings dial and then touch TIMER/CLOCK.
Appliance is not operating. A cook time appears in the display	The settings dial was turned accidentally	Touch START/STOP.
	After adjusting the setting, START/STOP was not touched	Touch START/STOP, or clear the setting by touching ON/OFF.
Appliance is not heating up. Three heat indicator bars appear in the display	A touchpad combination was touched	Disconnect from power and reconnect after approximately 20 seconds. Within 2 minutes, touch and hold PANEL LOCK for 4 seconds.
FB appears in the display	Automatic shutoff is activated	Touch any touch key.
 appears	Appliance has not been used for at least 2 days and the water tank is full	Empty and clean the water tank. Always empty the water tank after cooking.
The  indicator appears, but the water tank is full	Water tank was not inserted correctly	Slide in the water tank until it locks in place.
	Detection system not working	Call customer service.
The  indicator appears, but the water tank is not empty yet, or the water tank is empty, but the  indicator does not appear	Water tank is dirty. The moving water level detectors are stuck	Shake and clean the water tank. If the components are still stuck, obtain a new water tank through customer service.
Water tank empties without any apparent reason. Evaporator dish is overflowing.	Water tank was not closed properly	Close the tank lid until it clearly snaps into place.
	Tank lid seal is dirty	Clean the seal.
	Tank lid seal is defective	Obtain a new water tank through customer service.

Problem	Possible Cause	Tip/Solution
Evaporator dish has been boiled dry even though the water tank is full	Water tank was not inserted correctly	Slide in the water tank until it locks into place.
	Supply line is clogged	Descale appliance. Verify that the water hardness level is set correctly.
A "plop" noise can be heard when cooking	Temperature change affecting frozen food and caused by water vapor	This is normal.
An excessive amount of steam is produced when steaming	Appliance is being calibrated automatically	This is normal.
An excessive amount of steam is repeatedly produced when steaming	Appliance cannot be calibrated automatically when cooking for short periods of time	Reset the appliance to the factory setting (see <i>Basic Settings</i>). Next, start the Steam mode for 20 minutes at 210 °F (100° C).
Steam escapes from the vent openings when cooking		This is normal.
Appliance no longer produces steam correctly	The appliance needs to be descaled	Start Decalcify mode.
The error message "E.." appears in the display	Technical defect	Turn the settings dial to clear the error message and reset the clock, if necessary. If the error message reappears, contact customer service.
The error message "E011" appears in the display	A touchpad was touched for too long or is stuck	Turn the settings dial to clear the error message. Touch all touchpads individually to check if they are clean.

Technical service

Contact our Technical Service Department if your appliance needs repair. Our central Customer Service Center (see below) will also be happy to supply you with details on a center close to you.

E number and FD number:

When you contact our service, please have the Model (E) number and the FD number for your appliance available. You can find the data plate with these numbers on the bottom left side when you open the appliance door. To ensure that you can easily find the numbers in the event of a malfunction, write down the appliance information here.

Model no.	Serial no.
-----------	-------------------

Customer Service

Questions? Please contact us. We look forward to hearing from you!

1-800-735-4328
www.thermador.com
 1901 Main Street, Suite 600
 Irvine, CA 92614

How to Obtain Service or Parts

To reach a service representative, see the contact information at the front of the manual. Please be prepared with the information printed on your product rating label when calling.

Getting the Most Out of Your Appliance

General Tips

Accessories

Use the accessories that come with the appliance. When using steam with a perforated cooking pan, always slide the baking pan underneath it. The baking pan will catch any drippings..

Ovenware

If you use ovenware, always place it in the center of the rack.

The ovenware must be heat and steam resistant. Thick-walled ovenware extends the cooking time.

Use foil to cover food that would normally be prepared in a water bath (such as when melting chocolate).

Aluminum Foil

▲ WARNING

Do not use aluminum foil or protective liners to line any part of the appliance, especially the oven bottom. Installing these liners may result in risk of electric shock or fire.

Steaming

Steaming is a particularly gentle way to cook food. The steam envelopes the food, preventing the food from losing nutrients. No excess pressure is needed for cooking, allowing the food to maintain its shape, color and typical flavor.

Cooking Times and Quantities

When steaming, the cooking times are based on the size of the piece, not on the entire quantity of food. The appliance can steam up to 4.5 lbs. (2 kg) of food.

Note the sizes of pieces listed in the tables. The cooking time is shorter for smaller pieces and longer for larger pieces. The quality and age of the food also affect the cooking time. The values provided therefore serve only as a guideline.

Distribute Food Evenly

Always distribute the food evenly in the ovenware. If the food is placed unevenly in the ovenware, it will cook unevenly.

Delicate Food

Do not layer delicate foods too high in the cooking pan. It is better to use two pans in this case.

Cooking an Entire Meal

You can cook entire meals at the same time in Steam mode without mixing the flavors of the different food. Place the food with the longest cooking time in the appliance first and then add the remaining dishes at the appropriate time. This will ensure that all dishes are ready at the same time.

The total cooking time will be longer when cooking an entire meal, since every time the appliance door is opened, some steam escapes and the appliance has to reheat.

True Convection

True Convection is particularly suited for sweet and savory baked goods, braised meat and various cakes.

Cooking Charts

The charts can be used as a guide. Follow package or recipe directions.

These charts contain a selection of dishes that can be easily prepared in the steamer oven. You can find out

Slow Cooking Meat

Slow cooking is ideal for cooking tender cuts of meat that will be cooked medium rare. The meat stays very moist and is tender.

Place the baking pan in the combination oven and preheat the oven using Slow Cook mode.

Food	Amount	Accessories	Level	Oven mode	Temperature	Cooking time in min.
Boned leg of lamb	2 - 3.5 lbs (1 - 1.5 kg)	baking pan	2	Slow Cook	175 °F (80° C)	140 - 160
Roast beef	3.5 - 5.5 lbs (1.5 - 2.5 kg)	baking pan	2	Slow Cook	175 °F (80° C)	150 - 180
Pork fillets	-	baking pan	2	Slow Cook	175 - 195 °F (80 - 90° C)	50 - 70
Pork medallions	-	baking pan	2	Slow Cook	175 °F (80° C)	60 - 80
Beef steaks	approx. 1.2 in. (3 cm) thick	baking pan	2	Slow Cook	175 °F (80° C)	40 - 60
Duck breast	-	baking pan	2	Slow Cook	175 °F (80° C)	35 - 55

Reheating Food

Reheat mode gently reheats food. The food tastes and looks as if it were freshly prepared. Baked goods from

the day before can also be reheated to their original crispness.

Food	Accessories	Level	Oven mode	Temperature	Cooking time in min.
Dinner plate	wire rack	2	Reheat	250 °F (120° C)	12 - 18
Vegetables	baking pan	3	Reheat	210 °F (100° C)	12 - 15
Noodles, potatoes, rice	baking pan	3	Reheat	210 °F (100° C)	5 - 10
Bread rolls*	wire rack	2	Combination	340 - 360 °F (170 - 180° C)	6 - 8
Baguettes*	wire rack	2	Combination	340 - 360 °F (170 - 180° C)	5 - 10
Bread*	wire rack	2	Combination	340 - 360 °F (170 - 180° C)	8 - 12
Pizza	wire rack + baking pan	3	Reheat	340 - 360 °F (170 - 180° C)	12 - 15

* Preheat for 5 minutes

Defrosting

Freeze the food as flat as possible and in appropriate portions at -0 °F (-18° C). Do not freeze oversized portions. Defrosted food does not keep as long and spoils more quickly than fresh food.

Defrost food in the freezer bag on a plate or in the perforated cooking pan. Always slide the baking pan under the perforated cooking pan. This keeps the food from lying in the defrosted water and keeps the oven clean.

Use Defrost mode.

Let the food sit for another 5 to 15 minutes after it has thawed to complete defrosting.

⚠ WARNING

HEALTH HAZARD

When defrosting animal food products, make sure to remove the thawed liquid. The liquid must not come into contact with other food products. Germs could be transferred to the other food. After the food has thawed, heat up the steam oven using True Convection for 15 minutes at 360° F (180° C).

Defrosting meat

Thaw cuts of meat that will be breaded just until seasonings and bread crumbs can stick to the meat.

Defrosting poultry

Remove from packaging before defrosting. Make sure to pour out any defrosted liquid.

Food	Amount	Accessories	Level	Temperature	Cooking time in min.
Chicken parts, bone-in	2 lbs (1 kg)	perforated + baking pan	3 1	115 - 120° F (45 - 50 °C)	60 - 70
Chicken parts, boneless	1 lb (0.4 kg)	perforated + baking pan	3 1	115 - 120° F (45 - 50 °C)	30 - 35
Block-frozen vegetables (such as spinach)	1 lb (0.4 kg)	perforated + baking pan	3 1	115 - 120° F (45 - 50 °C)	20 - 30
Berries	0.66 lb (0.3 kg)	perforated + baking pan	3 1	115 - 120° F (45 - 50 °C)	5 - 8
Fish fillet	1 lb (0.4 kg)	perforated + baking pan	3 1	115 - 120° F (45 - 50 °C)	15 - 20
Beef	2 lbs (1 kg)	perforated + baking pan	3 1	115 - 120° F (45 - 50 °C)	70 - 80

Proofing Dough

The dough rises much faster using this mode than at room temperature.

You can choose any rack level for the rack or carefully place the rack on the oven bottom.

NOTICE: Do not scratch the oven bottom.

Place the dough-rising bowl on the rack. Do not cover the dough.

Food	Amount/weight	Ovenware	Temperature	Cooking time in min.
Yeast dough	2 lbs (1 kg)	bowl + wire rack	105° F (40 °C)	20 - 30
Sourdough	2 lbs (1 kg)	bowl + wire rack	105° F (40 °C)	20 - 30

Vegetables

Place the vegetables in the perforated cooking pan and place at rack level 3. Place the baking pan underneath at rack level 1. The baking pan will catch any drippings.

Food	Size	Accessories	Operating mode	Temperature	Cooking time in min.
Artichokes	whole	perforated + baking tray	Steam	210 °F (100° C)	30 - 35
Cauliflower	whole	perforated + baking tray	Steam	210 °F (100° C)	30 - 40
Cauliflower	florets	perforated + baking tray	Steam	210 °F (100° C)	10 - 15
Broccoli	florets	perforated + baking tray	Steam	210 °F (100° C)	8 - 10
Peas	-	perforated + baking tray	Steam	210 °F (100° C)	5 - 10
Fennel	slices	perforated + baking tray	Steam	210 °F (100° C)	10 - 14
Stuffed vegetables (zucchini, eggplant, peppers)	Do not precook vegetables	baking tray at level 2	Combina-tion	320 - 360 °F (160 - 180° C)	15 - 30
Green beans	-	perforated + baking tray	Steam	210 °F (100° C)	15 - 20
Carrots	slices	perforated + baking tray	Steam	210 °F (100° C)	10 - 20
Kohlrabi	slices	perforated + baking tray	Steam	210 °F (100° C)	15 - 20

* Preheat the appliance

Food	Size	Accessories	Operating mode	Temperature	Cooking time in min.
Leeks	slices	perforated + baking tray	Steam	210 °F (100° C)	4 - 6
Swiss chard*	shredded	perforated + baking tray	Steam	210 °F (100° C)	8 - 10
Green asparagus*	whole	perforated + baking tray	Steam	210 °F (100° C)	7 - 12
White asparagus*	whole	perforated + baking tray	Steam	210 °F (100° C)	10 - 15
Spinach*	-	perforated + baking tray	Steam	210 °F (100° C)	2 - 3
Brussels sprouts	sprouts	perforated + baking tray	Steam	210 °F (100° C)	20 - 30
Red beets	whole	perforated + baking tray	Steam	210 °F (100° C)	40 - 50
Red cabbage	shredded	perforated + baking tray	Steam	210 °F (100° C)	30 - 35
Cabbage	shredded	perforated + baking tray	Steam	210 °F (100° C)	25 - 35
Zucchini	slices	perforated + baking tray	Steam	210 °F (100° C)	2 - 3
Peapods	-	perforated + baking tray	Steam	210 °F (100° C)	8 - 12

* Preheat the appliance

Side Dishes and Legumes

Add the appropriate amount of water or liquid.
Example: 1 : 1.5 = for every ½ cup of rice, add ¾ cup of water.

You can choose any rack level for the cooking pan.

Food	Ratio	Accessories	Level	Oven mode	Temperature	Duration in min.
Unpeeled boiled potatoes (Medium size)	-	Perforated + baking pan	3 1	Steam	210 °F (100° C)	35 - 45
Boiled potatoes (Quartered)	-	Perforated + baking pan	3 1	Steam	210 °F (100° C)	20 - 25
Potato gratin	-	Baking pan	2	True Convection	340 - 360° F (170 - 180° C)	35 - 45
Brown rice	1:1,5	Cooking pan	-	Steam	210 °F (100° C)	30 - 40
Long grain rice	1:1,5	Cooking pan	-	Steam	210 °F (100° C)	20 - 30
Basmati rice	1:1,5	Cooking pan	-	Steam	210 °F (100° C)	20 - 30
Parboiled rice	1:1,5	Cooking pan	-	Steam	210 °F (100° C)	15 - 20
Lentils	1:2	Cooking pan	-	Steam	210 °F (100° C)	30 - 45
Canellini beans, pre-softened	1:2	Cooking pan	-	Steam	210 °F (100° C)	65 - 75
Couscous	1:1	Cooking pan	-	Steam	210 °F (100° C)	6 - 10
Dumplings	-	Perforated + baking pan	3 1	Steam	205 °F (95° C)	20 - 25

Poultry, Meat, Fish

Insert rack and baking pan together at the same rack level.

Once the roast is done, let it rest in the closed steamer oven for an additional 10 minutes after turning it off. This will help the meat retain its juices.

Using the Combination oven mode makes the meat particularly tender and juicy on the inside while forming a crust on the outside.

Poultry

Food	Amount/ weight	Accessories	Level	Oven mode	Temperature	Cooking time in min.
Chicken, whole	2.65 lbs (1.2 kg)	wire rack + baking pan	2	Combination	360 - 375 °F (180 - 190° C)	50 - 60
Chicken, halved	per 1 lbs (0.4 kg)	wire rack + baking pan	2	Combination	360 - 375 °F (180 - 190° C)	35 - 45
Chicken breast	per 0.33 lbs (0.15 kg)	perforated + baking pan	3 1	Steam	210 °F (100° C)	15 - 25
Chicken piece	per 2.65 lbs (0.12 kg)	wire rack + baking pan	2	Combination	360 - 390 °F (180 - 200° C)	20 - 35
Duck, whole	4.5 lbs (2 kg)	wire rack + baking pan	2	Combination	340 °F (170° C)	60 - 80
				True Convec- tion	410 °F (210° C)	15 - 20
Duck breast*	per (0.35 kg)	wire rack + baking pan	2	Combination	340 - 360 °F (170 - 180° C)	10 - 15
Turkey, whole, unstuffed	8 - 11 lbs	wire rack + baking pan	1	Combination	325 °F (165° C)	15 - 75
Turkey, whole, unstuffed**	12 - 14 lbs	wire rack + baking pan	1	Combination	325 °F (165° C)	80 - 95
Rolled turkey roast	3.5 lbs (1.5 kg)	wire rack + baking tray	2	Combination	300 - 320 °F (150 - 160° C)	70 - 90
Turkey breast	2 lbs (1 kg)	wire rack + baking tray	2	Combination	300 - 320 °F (150 - 160° C)	60 - 80

* Sear first

** Use baking pan 1 5/8" deep (see *Additional Accessories*)

Beef

Food	Amount/ weight	Accessories	Level	Oven mode	Temperature	Cooking time in min.
Pot-roast beef*	3.5 lbs (1,5 kg)	Wire rack + baking pan	2	Reheat	285 - 300 °F (140 - 150° C)	100 - 140
Fillet of beef, medium*	2 lbs (1 kg)	Wire rack + baking pan	2	Reheat	340 - 360 °F (170 - 180° C)	20 - 28
Thin slice of roast beef, medium*	2 lbs (1 kg)	Wire rack + baking pan	2	True Convec- tion	340 - 360 °F (170 - 180° C)	40 - 55
Thick cut of sirloin, medium*	2 lbs (1 kg)	Wire rack + baking pan	2	True Convec- tion	340 - 360 °F (170 - 180° C)	45 - 60

* Sear first

Veal

Food	Amount/ weight	Accessories	Level	Oven mode	Temperature	Cooking time in min.
Veal, bone-in	3.5 lbs (1.5 kg)	wire rack + baking pan	2	Combination	320 - 360 °F (160 - 180° C)	50 - 70

* Sear first

Food	Amount/ weight	Accessories	Level	Oven mode	Temperature	Cooking time in min.
Veal, loin*	2 lbs (1 kg)	wire rack + baking pan	2	Combination	320 - 360 °F (160 - 180° C)	15 - 25
Breast of veal, stuffed	3.5 lbs (1.5 kg)	wire rack + baking pan	2	Combination	285 - 320 °F (140 - 160° C)	75 - 120

* Sear first

Pork

Food	Amount/ weight	Accessories	Level	Oven mode	Temperature	Cooking time in min.
Bone-in without rind	3.5 lbs (1.5 kg)	wire rack + baking pan	2	Combination	340 - 360 °F (170 - 180° C)	70 - 80
Bone-in with rind	3.5 lbs (1.5 kg)	wire rack + baking pan	2	Steam	210 °F (100° C)	20 - 25
				Combination	285 - 320 °F (140 - 160° C)	40 - 50
				True Convection	410 - 430 °F (210 - 220° C)	20
Pork chop, boneless*	1.2 lbs (0.5 kg)	wire rack + baking pan	2	Combination	320 - 360 °F (160 - 180° C)	20 - 30
Fillet in puff pastry	2 lbs (1 kg)	baking pan	2	Combination	360 - 390 °F (180 - 200° C)	40 - 60
Smoked pork on the bone	2 lbs (1 kg)	wire rack + baking pan	2	Combination	250 - 285 °F (120 - 140° C)	60 - 70
Smoked pork ribs	sliced	baking pan	2	Steam	210 °F (100° C)	15 - 20
Rolled roast	3.5 lbs (1.5 kg)	wire rack + baking pan	2	Combination	340 - 360 °F (170 - 180° C)	70 - 80

* Sear first

Other

Food	Amount/ weight	Accessories	Level	Oven mode	Temperature	Cooking time in min.
Meat loaf	made from 1.2 lbs (0.5 kg) minced meat	baking pan	2	Combination	340 - 360 °F (170 - 180° C)	45 - 60
Boned leg of lamb	3.5 lbs (1.5 kg)	wire rack + baking pan	2	Combination	340 - 360 °F (170 - 180° C)	60 - 80
Loin of lamb on the bone*	3.5 lbs (1.5 kg)	wire rack + baking pan	2	Combination	320 - 340 °F (160 - 170° C)	15 - 25
Wiener sausages	-	perforated + baking pan	3 1	Steam	175 - 185 °F (80 - 85° C)	12 - 18

* Sear first

Fish

Food	Amount/ weight	Accessories	Level	Oven mode	Temperature	Cooking time in min.
Whole	per 0.66 lbs (0.3 kg)	perforated + baking tray	3	Steam	175 - 195 °F (80 - 90° C)	15 - 25
			1			
Fillet	per 3.5 lbs (0.15 kg)	perforated + baking tray	3	Steam	175 - 195 °F (80 - 90° C)	10 - 20
			1			
Trout, whole	per 0.5 lbs (0.2 kg)	perforated + baking tray	3	Steam	175 - 195 °F (80 - 90° C)	12 - 15
			1			
Cod fillet	per 0.33 lbs (0.15 kg)	perforated + baking tray	3 1	Steam	175 - 195 °F (80 - 90° C)	10 - 14

Food	Amount/ weight	Accessories	Level	Oven mode	Temperature	Cooking time in min.
Salmon fillet	per 0.33 lbs (0.15 kg)	perforated + baking tray	3 1	Steam	210 °F (100° C)	8 - 10
Clams, oysters	0.33 lbs (1.5 kg)	baking tray	2	Steam	210 °F (100° C)	10 - 15
Haddock, perch fillet	per 0.5 lbs (0.15 kg)	perforated + baking tray	3 1	Steam	175 - 195 °F (80 - 90° C)	10 - 20
Sole rolls, stuffed	-	perforated + baking tray	3 1	Steam	175 - 195 °F (80 - 90° C)	10 - 20
Shrimp, large	per 1 lb (0.4 kg)	perforated + baking tray	3 1	Steam	210 °F (100° C)	8 - 13
Shrimp, medium	per 1 lb (0.4 kg)	perforated + baking tray	3 1	Steam	210 °F (100° C)	5 - 8

Roasting Tips

When is the roast done?	Use a meat thermometer (available in stores) to measure the meat temperature.
The roast is too dark and the crust is burnt in some areas.	Check the rack level and temperature.
The roast turned out well, but the sauce is burned.	Next time, use a smaller roasting pan or add more liquid.
The roast looks good, but the sauce is too light and runny.	Next time, use a larger roasting pan or add less liquid.

Soufflés, Casseroles, Additions to Soups, etc.

Food	Accessories	Level	Oven mode	Temperature	Cooking time in min.
Lasagna	baking pan	2	Combination	320 - 340 °F (160 - 170° C)	35 - 45
Soufflés	soufflé dish + baking pan	2	Combination	360 - 390 °F (180 - 200° C)	15 - 25
Semolina dumplings	perforated + baking pan	3 1	Steam	195 - 205 °F (90 - 95° C)	7 - 10

Desserts, compote

Compote

Weigh out the fruit, add approximately $\frac{1}{3}$ the amount of water and add sugar and spices to taste.

Rice pudding

Weigh out the rice and add 2.5 times as much milk. Add the rice and milk no higher than $\frac{1}{2}$ inch (2.5 cm) up the side of the accessory. Stir after cooking. The remaining milk will be absorbed quickly.

Yogurt

Heat the milk to 195° F (90 °C) on the cooktop. Remove from heat and let cool to 105° F (40 °C). Heating the milk is not required if using ultra high temperature (UHT) milk.

Stir in one to two teaspoons of plain yogurt or the appropriate amount of yogurt starter per 100 ml milk. Pour the mixture into clean glass jars and cover with lids. After preparation, leave the glass jars in the refrigerator to cool.

Food	Accessories	Oven mode	Temperature	Cooking time in min.
Yeast dumplings	baking pan	Steam	210 °F (100° C)	20 - 25
Egg custard	mold + wire rack	Steam	195 - 210 °F (90 - 100° C)	15 - 20
Sweet baked items (such as rice pudding)	ovenproof dish + wire rack	Combination	320 - 340 °F (160 -170° C)	50 - 60
Rice pudding*	baking pan	Steam	210 °F (100° C)	25 - 35
Yogurt*	portion-sized jars + wire rack	Steam	105 °F (40° C)	300 - 360
Apple compote	baking pan	Steam	210 °F (100° C)	10 - 15

* You can also use the appropriate program (see section: *Automatic Programming*)

Food	Accessories	Oven mode	Temperature	Cooking time in min.
Pear compote	baking pan	Steam	210 °F (100° C)	10 - 15
Cherry compote	baking pan	Steam	210 °F (100° C)	10 - 15
Rhubarb compote	baking pan	Steam	210 °F (100° C)	10 - 15
Plum compote	baking pan	Steam	210 °F (100° C)	15 - 20

* You can also use the appropriate program (see section: *Automatic Programming*)

Cakes and Baked Goods

Dark metal baking pans are recommended. The temperature and cooking time depend on the quantity and consistency of the dough. Temperature ranges are therefore provided in the charts.

Start with a lower temperature setting. This will provide for more even browning. Use a higher temperature setting the next time, if necessary.

Do not overfill the rack or baking pan.

Food	Accessories	Level	Oven mode	Temperature	Cooking time in min.
Sponge cake	10-inch tube pan	2	True Convection	300 - 320 °F (150 -160° C)	60 - 70
Sponge flan base	ring	2	True Convection	300 - 320 °F (150 -160° C)	30 - 45
Delicate fruit flan, sponge	springform cake pan	2	True Convection	300 - 320 °F (150 -160° C)	45 - 55
Sponge base (2 eggs)	ring	2	True Convection	360 - 375 °F (180 -190° C)	12 - 16
Sponge flan (6 eggs)	springform cake pan	2	True Convection	300 - 320 °F (150 -160° C)	25 - 35
Shortcrust pastry base with crust	springform cake pan	2	True Convection	300 - 320 °F (150 -160° C)	40 - 50
Swiss flan	springform cake pan	2	True Convection	360 - 375 °F (180 -190° C)	35 - 60
Bundt	Bundt cake pan	2	Combination	300 - 320 °F (150 -160° C)	35 - 45
Savoury cakes (such as quiche)	quiche dish	2	True Convection	360 - 375 °F (180 -190° C)	35 - 60
Apple tart	flan-base cake pan	2	True Convection	340 - 375 °F (170 -190° C)	35 - 50

Food	Accessories	Level	Operating mode	Temperature	Cooking time in min.
Yeast cake with dry topping	baking pan	2	Combination	300 - 320 °F (150 -160° C)	35 - 45
			True Convection	300 - 320 °F (150 -160° C)	35 - 45
Swiss roll	baking pan	2	True Convection	360 - 390 °F (180 -200° C)	10 - 15
Braided loaf	baking pan	2	Combination	300 - 320 °F (150 -160° C)	25 - 35
Strudel, sweet	baking pan	2	Combination	320 - 360 °F (160 -180° C)	40 - 60
Onion tart	baking pan	2	Combination	340 - 360 °F (170 -180° C)	30 - 40

Bread, Bread Rolls

Food	Accessories	Level	Oven mode	Temperature	Cooking time in min.
White bread, 1.7 lbs (0.75 kg) flour	baking pan + parchment paper	2	Combination	390 - 410 °F (200 - 210° C)	15 - 20
			True Convection	320 - 340 °F (160 - 170° C)	20 - 25
Sourdough bread, 1.7 lbs (0.75 kg) flour	baking pan + parchment paper	2	Combination	390 - 430 °F (200 - 220° C)	15 - 25
			True Convection	300 - 320 °F (150 - 160° C)	40 - 60
Multigrain bread, 1.7 lbs (0.75 kg) flour	baking pan + parchment paper	2	Combination	390 - 430 °F (200 - 220° C)	15 - 20
			True Convection	320 - 340 °F (160 - 170° C)	25 - 40
Whole grain bread, 1.7 lbs (0.75 kg) flour	baking pan + parchment paper	2	Combination	390 - 430 °F (200 - 220° C)	20 - 30
			True Convection	285 - 300 °F (140 - 150° C)	40 - 60
Rye bread, 1.7 lbs (0.75 kg) flour	baking pan + parchment paper	2	Combination	390 - 430 °F (200 - 220° C)	20 - 30
			True Convection	300 - 320 °F (150 - 160° C)	50 - 60
Bread rolls, 0.15 lbs (70 g) each, unbaked	baking pan + parchment paper	2	Combination	375 - 390 °F (190 - 200° C)	25 - 30
Bread rolls made with seet yeast dough, 0.15 lbs (70 g) each, unbaked	baking pan + parchment paper	2	Combination	340 - 360 °F (170 - 180° C)	20 - 30

Small Baked Products

Food	Accessories	Level	Operating mode	Temperature	Cooking time in min.
Meringue	baking pan	2	True Convection	175 - 195° F (80 - 90 °C)	120 - 180
Macaroons	baking pan	2	True Convection	285 - 320° F (140 - 160 °C)	15 - 25
Puff pastry	baking pan	2	Combination	340 - 375° F (170 - 190 °C)	10 - 20
Muffins	muffin pan	2	True Convection	340 - 360° F (170 - 180 °C)	20 - 30
Choux pastry, such as cream puffs	baking pan	2	True Convection	340 - 375° F (170 - 190 °C)	27 - 35
Biscuits	baking pan	2	True Convection	300 - 320° F (150 - 160 °C)	12 - 17
Leavened cake, such as apple cake	baking pan	2	True Convection	300 - 320° F (150 - 160 °C)	15 - 20

Baking Tips

If using your own recipe	Look at cakes or baked goods in the table that are similar to your recipe.
This will help to determine if the cake is cooked through	About 10 minutes before the end of baking time according to your recipe, stick a toothpick into the highest part of the cake. The cake is done when the batter no longer sticks to the toothpick.
The cake collapses	Next time, use less liquid or set oven temperature 20° F (10 °C) lower. Use the mixing times specified in the recipe.
The center of the cake is higher than on the sides	Do not grease the sides of the springform or cake pan. After baking, carefully remove the cake from the pan using a knife
Springform of loaf cake is too dark in the back	Do not place the baking pan up against the back wall of the oven. Place it on the center of the rack.
The cake is too dry	Use a toothpick to make tiny holes in the finished cake and pour drops of fruit juice or alcoholic beverage over the cake. Next time, set the temperature 20° F (10 °C) higher and shorten the baking time or use the Combination oven mode.
The bread or cake looks good, but is runny inside (overly moist, has streaks of liquid running through it)	Next time, use less liquid. Bake a little longer and at a lower temperature. Pre-bake crusts for pies and cakes with juicy/runny fillings. Sprinkle crust with almonds or bread crumbs and then add the filling. Observe the baking time specified in the recipe
Cakes or baked goods brown unevenly	Set the temperature a little lower next time

Juice Extraction

Before extracting juice from berries, place the berries in a bowl and add sugar. Let the berries sit for one hour so that the juice is drawn out.

Place the berries into the perforated cooking pan and place pan at rack level 3. To catch the juice, place the non-perforated cooking pan at rack level 1. When ready, pour the berries into a cheese cloth and squeeze out the remaining juice.

Food	Accessories	Level	Oven mode	Temperature	Cooking time in min.
Raspberries	Perforated + cooking pan	3 1	Steam	210° F (100 °C)	30 - 45
Red currants	Perforated + cooking pan	3 1	Steam	210° F (100 °C)	40 - 50

Frozen products

Follow the manufacturer's instructions on the packaging.

The specified cooking times apply to dishes placed in a cold oven.

Food	Accessories	Level	Oven mode	Temperature	Cooking time in min.
French fries	baking pan + parchment paper	2	True Convection	340 - 375° F (170 - 190 °C)	25 - 35
Croquettes	baking pan + parchment paper	2	True Convection	360 - 390° F (180 - 200 °C)	18 - 22
Thinly sliced fried potatoes	baking pan + parchment paper	2	True Convection	360 - 390° F (180 - 200 °C)	25 - 30
Pasta, fresh, refrigerated*	baking pan	2	Steam	210° F (100 °C)	5 - 10
Lasagna, frozen	baking pan + wire rack	2	Combination	375 - 410° F (190 - 210 °C)	35 - 55
Pizza, thin crust	baking pan + wire rack	2	True Convection	360 - 390° F (180 - 200 °C)	15 - 23
Pizza, deep dish	baking pan + wire rack	2	True Convection	360 - 390° F (180 - 200 °C)	18 - 25
Pizza, French bread	baking pan + wire rack	2	True Convection	360 - 390° F (180 - 200 °C)	18 - 22

* Add a little liquid

Food	Accessories	Level	Oven mode	Temperature	Cooking time in min.
Pizza, chilled	baking pan + parchment paper	2	True Convection	340 - 360° F (170 - 180 °C)	12 - 17
Herb butter baguette, refrigerated	baking pan	2	True Convection	360 - 390° F (180 - 200 °C)	15 - 20
Bread rolls, baguette, frozen	baking pan + wire rack	2	True Convection	360 - 390° F (180 - 200 °C)	18 - 22
Pretzels, frozen	baking pan + parchment paper	2	True Convection	360 - 390° F (180 - 200 °C)	18 - 22
Partially cooked bread rolls or baguette, pre-baked	baking pan + parchment paper	2	True Convection	300 - 340° F (150 - 170 °C)	12 - 15
Strudel, frozen	baking pan + parchment paper	2	Combination	320 - 360° F (160 - 180 °C)	45 - 60
Fish sticks	baking pan + parchment paper	2	True Convection	380 - 400° F (195 - 205 °C)	20 - 24
Whole fish	perforated + baking pan	3 1	Steam	175 - 210° F (80 - 100 °C)	20 - 25
Frozen fish fillet	baking pan + wire rack	2	Combination	360 - 390° F (180 - 200 °C)	35 - 50
Salmon fillets	Perforated + cooking pan	3 1	Steam	175 - 210° F (80 - 100 °C)	20 - 25
Broccoli	Perforated + cooking pan	3 1	Steam	210° F (100 °C)	4 - 6
Cauliflower	Perforated + cooking pan	3 1	Steam	210° F (100 °C)	5 - 8
Green beans	Perforated + cooking pan	3 1	Steam	210° F (100 °C)	4 - 6
Peas	Perforated + cooking pan	3 1	Steam	210° F (100 °C)	4 - 6
Carrots	Perforated + cooking pan	3 1	Steam	210° F (100 °C)	3 - 5
Mixed vegetables	Perforated cooking pan + baking pan	3 1	Steam	210° F (100 °C)	4 - 8
Brussels sprouts	Perforated cooking pan + baking pan	3 1	Steam	210° F (100 °C)	5 - 10

* Add a little liquid

STATEMENT OF LIMITED PRODUCT WARRANTY

What this Warranty Covers & Who it Applies to

The limited warranty provided by BSH Home Appliances in this Statement of Limited Product Warranty applies only to the Thermador Built-in Oven sold to you, the first using purchaser, provided that the Product was purchased:

- For your normal, household (non-commercial) use, and has in fact at all times only been used for normal household purposes.
- New at retail (not a display, "as is", or previously returned model), and not for resale, or commercial use.
- Within the United States or Canada, and has at all times remained within the country of original purchase.

The warranties stated herein apply only to the first purchaser of the Product and are not transferable.

Thermador reserves the right to request proof of purchase at the time any warranty claim is submitted to confirm that the Product falls within the scope of this limited product warranty.

Please make sure to return your registration card; while not necessary to effectuate warranty coverage, it is the best way for Thermador to notify you in the unlikely event of a safety notice or product recall.

How Long the Warranty Lasts

BSH warrants that the Product is free from defects in materials and workmanship for a period of seven hundred and thirty (730) days from the date of purchase. The foregoing timeline begins to run upon the date of purchase, and shall not be stalled, tolled, extended, or suspended, for any reason whatsoever.

This Product is also warranted to be free from *cosmetic* defects in material and workmanship (such as scratches of stainless steel, paint/porcelain blemishes, chip, dents, or other damage to the finish of the Product), for a period of sixty (60) days from the date of purchase or closing date for new construction. This *cosmetic* warranty excludes slight color variations due to inherent differences in painted and porcelain parts, as well as differences caused by kitchen lighting, product location, or other similar factors. This *cosmetic* warranty specifically excludes any display, floor, "As Is", or "B" stock appliances.

Repair/Replace as Your Exclusive Remedy

During this warranty period, BSH or one of its authorized service providers will repair your Product without charge to you (subject to certain limitations stated herein) if your Product proves to have been manufactured with a defect in materials or workmanship. If reasonable attempts to repair the Product have been made without success, then BSH will replace your Product (upgraded models may be available to you, in BSH's sole discretion, for an additional charge). All removed parts and components shall become the property of BSH at its sole option. All replaced and/or repaired parts shall assume the identity

of the original part for purposes of this warranty and this warranty shall not be extended with respect to such parts. BSH's sole liability and responsibility hereunder is to repair manufacturer-defective Product only, using a BSH-authorized service provider during normal business hours. For safety and property damage concerns, BSH highly recommends that you do not attempt to repair the Product yourself, or use an un-authorized servicer; BSH will have no responsibility or liability for repairs or work performed by a non-authorized servicer. If you choose to have someone other than an authorized service provider work on your Product, THIS WARRANTY WILL AUTOMATICALLY BECOME NULL AND VOID. Authorized service providers are those persons or companies that have been specially trained on BSH products, and who possess, in BSH's opinion, a superior reputation for customer service and technical ability (note that they are independent entities and are not agents, partners, affiliates or representatives of BSH). Notwithstanding the foregoing, BSH will not incur any liability, or have responsibility, for the Product if it is located in a remote area (more than 100 miles from an authorized service provider) or is reasonably inaccessible, hazardous, threatening, or treacherous locale, surroundings, or environment; in any such event, if you request, BSH would still pay for labor and parts and ship the parts to the nearest authorized service provider, but you would still be fully liable and responsible for any travel time or other special charges by the service company, assuming they agree to make the service call.

Out of Warranty Product

BSH is under no obligation, at law or otherwise, to provide you with any concessions, including repairs, pro-rates, or Product replacement, once this warranty has expired.

Warranty Exclusions

The warranty coverage described herein excludes all defects or damage that are not the direct fault of BSH, including without limitation, one or more of the following:

- Use of the Product in anything other than its normal, customary and intended manner (including without limitation, any form of commercial use, use or storage of an indoor product outdoors, use of the Product in conjunction with air or water-going vessels).
- Any party's willful misconduct, negligence, misuse, abuse, accidents, neglect, improper operation, failure to maintain, improper or negligent installation, tampering, failure to follow operating instructions, mishandling, unauthorized service (including self-performed "fixing" or exploration of the appliance's internal workings).
- Adjustment, alteration or modification of any kind.
- A failure to comply with any applicable state, local, city, or county electrical, plumbing and/or building codes, regulations, or laws, including failure to install the product in strict conformity with local fire and building codes and regulations.

- Ordinary wear and tear, spills of food, liquid, grease accumulations, or other substances that accumulate on, in, or around the Product.
- Any external, elemental and/or environmental forces and factors, including without limitation, rain, wind, sand, floods, fires, mud slides, freezing temperatures, excessive moisture or extended exposure to humidity, lightning, power surges, structural failures surrounding the appliance, and acts of God.

In no event shall BSH have any liability or responsibility whatsoever for damage to surrounding property, including cabinetry, floors, ceilings, and other structures or objects around the Product. Also excluded from this warranty are scratches, nicks, minor dents, and cosmetic damages on external surfaces and exposed parts; Products on which the serial numbers have been altered, defaced, or removed; service visits to teach you how to use the Product, or visits where there is nothing wrong with the Product; correction of installation problems (you are solely responsible for any structure and setting for the Product, including all electrical, plumbing or other connecting facilities, for proper foundation/flooring, and for any alterations including without limitation cabinetry, walls, floors, shelving, etc.); and resetting of breakers or fuses.

TO THE EXTENT ALLOWED BY LAW, THIS WARRANTY SETS OUT YOUR EXCLUSIVE REMEDIES WITH RESPECT TO PRODUCT, WHETHER THE CLAIM ARISES IN CONTRACT OR TORT (INCLUDING STRICT LIABILITY, OR NEGLIGENCE) OR OTHERWISE. THIS WARRANTY IS IN LIEU OF ALL OTHER WARRANTIES, WHETHER EXPRESS OR IMPLIED. ANY WARRANTY IMPLIED BY LAW, WHETHER FOR MERCHANTABILITY OR FITNESS FOR A PARTICULAR PURPOSE, OR OTHERWISE, SHALL BE EFFECTIVE ONLY FOR THE PERIOD THAT THIS EXPRESS LIMITED WARRANTY IS EFFECTIVE. IN NO EVENT WILL THE MANUFACTURER BE LIABLE FOR CONSEQUENTIAL, SPECIAL, INCIDENTAL, INDIRECT, "BUSINESS LOSS", AND/OR PUNITIVE DAMAGES, LOSSES, OR EXPENSES, INCLUDING WITHOUT LIMITATION TIME AWAY FROM WORK, HOTELS AND/OR RESTAURANT MEALS, REMODELLING EXPENSES IN EXCESS OF DIRECT DAMAGES WHICH ARE DEFINITELY CAUSED EXCLUSIVELY BY BSH, OR OTHERWISE. SOME STATES DO NOT ALLOW THE EXCLUSION OR LIMITATION OF INCIDENTAL OR CONSEQUENTIAL DAMAGES, AND SOME STATES DO NOT ALLOW LIMITATIONS ON HOW LONG AN IMPLIED WARRANTY LASTS, SO THE ABOVE LIMITATIONS MAY NOT APPLY TO YOU. THIS WARRANTY GIVES YOU SPECIFIC LEGAL RIGHTS, AND YOU MAY ALSO HAVE OTHER RIGHTS WHICH VARY FROM STATE TO STATE.

No attempt to alter, modify or amend this warranty shall be effective unless authorized in writing by an officer of BSH.



1901 MAIN STREET, SUITE 600 IRVINE, CA 92614 // 1-800-735-4328 // WWW.THERMADOR.COM
© 2018 BSH HOME APPLIANCES CORPORATION
9001387736 en-us 981122