



SIEMENS



Washer dryer

WD14U520GC

en User manual and installation instructions



Register your product on My Siemens and discover exclusive services and offers.
siemens-home.bsh-group.com/welcome

The future moving in.

Siemens Home Appliances

Your new washer dryer

You have chosen a Siemens washer dryer.

Please take a few minutes to read and become familiar with the advantages of your washer dryer.

To meet the high quality demands required by Siemens, every washer dryer that leaves our factory is carefully checked to ensure that it functions correctly and is in perfect condition.

For more information on our products, accessories, replacement parts and services, see our website www.siemens-home.bsh-group.com or contact our after-sales service centres.

If the operating and installation instructions describe different models, any differences will be pointed out at the relevant points in the text.



Read these operating and installation instructions before switching on the washer dryer.

Display rules

Warning!

This combination of symbol and signal word indicates a possibly dangerous situation. Not heeding the warning can cause death or injuries.

Caution!

This signal word indicates a possibly dangerous situation. Not heeding the caution can cause property and/or environmental damage.

Note/tip

Information about the optimum use of the appliance/any other useful information.

1. 2. 3. / a) b) c)

The steps are represented by numbers or letters.

■ / -

Lists are represented by a small box or a dash.

Contents

 Intended use	4
--	---

 Safety instructions	5
---	---

Children/people/pets	5
Installation	6
Operation	8
Cleaning/Maintenance	10

 Environmental protection	11
--	----

Packaging/used appliance	11
Tips on economical use	11

 Positioning and connecting	12
--	----

Standard accessories	12
Safety instructions	13
Installation surface	13
Installation on a base or a wooden joist floor	13
Installing the appliance in a kitchenette	14
Removing the transport locks	14
Hose and cable lengths	16
Water inlet	16
Water outlet	17
Alignment	18
Electrical connection	19
Before washing for the first time	19
Transportation	20

 Getting to know the appliance	21
---	----

Appliance	21
Control panel	22
Touch-Display	23

 Laundry	24
---	----

Preparing laundry for washing	24
Preparing laundry for drying	25

 Overview of programmes	26
--	----











Selectable programme	26
Drying table	30
Starching	30

Dyeing/bleaching	30
------------------------	----

 Programme default settings	31
---	----

Temperature	31
Spin speed	31
Finish in	31

 Additional programme settings	32
--	----

Wash+Dry	32
Dry	32
 (Cupboard dry)	32
 (Cupboard dry+)	32
 (Iron dry)	32
 Speed	32
 Eco	32
 (Prewash)	32
 (Rinse plus)	32
 (Easy iron)	33
 (Water plus)	33
 (Memory)	33
 (Silent)	33

 Operating the appliance	33
--	----

Preparing the appliance	33
Switching on the appliance/selecting a programme	34
Placing laundry into the drum	34
Dosing and adding detergent and care products	35
Starting the programme	36
Childproof lock	36
Adding/removing laundry	37
Changing the programme	37
Cancel the programme	37
Programme end	37
Removing laundry/switching off the appliance	38

 Appliance settings	38
---	----

Automatic switch-off	38
Basic settings	38

 Sensors	39
--	----

Unbalanced load detection system	39
--	----



Cleaning and maintenance . . . 40

Appliance housing/control panel . . .	40
Drum	40
Descaling.	40
Detergent drawer and housing	40
Drain pump is blocked	41
The drain hose at the siphon is blocked	42
Filter in the water supply is blocked	42



Faults and what to do about them 43

Emergency release	43
Information on the display panel . . .	44
Faults and what to do about them. .	45



After-sales service 49



Consumption values 50



Technical data. 51



Aqua-Stop warranty 51



Intended use

- This appliance is intended for private domestic use only.
- Do not install or operate this appliance anywhere that is liable to experience frost and/or outdoor conditions. There is a risk that the appliance will be damaged if residual water in it freezes. If hoses freeze up, they may crack/burst.
- This appliance must only be used for washing domestic laundry, consisting of machine-washable items and hand-washable woollens (see label on item). Using the appliance for any other purpose is outside of the scope of its intended application and is forbidden.
- This appliance must only be used for drying and freshening up domestic laundry, consisting of items that have been washed with water and are suitable for tumble drying (see label on item). Using the appliance for any other purpose is outside of the scope of its intended application and is forbidden.
- This appliance is suitable for operation with mains water and commercially available detergents and care products (must be suitable for use in washing machines).
- This appliance is intended for use up to a maximum height of 4000 metres above sea level.

Before you switch on the appliance:

Check that there is no visible damage to the appliance. Do not operate the appliance if it is damaged. Should you have any problems, please contact your specialist dealer or our customer service.

Read and follow the operating and installation instructions and all other information provided with this appliance.

Retain the documents for subsequent use or for subsequent owners.

Safety instructions

The following safety information and warnings are provided to protect you from injury and to prevent material damage to your surroundings.

It is nevertheless important to take the necessary precautions and to proceed with care when installing, maintaining, cleaning and operating the appliance.

Children/people/pets

Warning **Risk of death!**

Children and other people who are unable to assess the risks involved when using the appliance may injure themselves or may find themselves in life-threatening situations. Therefore please note:

- The appliance may be used by children over the age of 8 years and by persons with reduced physical, sensory or mental capacity or by persons with a lack of experience or knowledge as long as they are supervised or have received instruction on how to use the appliance safely and they have understood the potential risks of using the appliance.
- Children must not play with this appliance.

- Do not allow children to clean or maintain this appliance unsupervised.
- Keep children under 3 years and pets away from this appliance.
- Do not leave the appliance unattended when children or other people who are unable to assess the risks are in the vicinity.

Warning **Risk of death!**

Children may lock themselves inside appliances and find themselves in a life-threatening situation.

- Do not position the appliance behind a door, as this may obstruct the appliance door or prevent it from opening completely.
- Once an appliance has reached the end of its life, pull the mains plug from the socket **before** severing the mains cable, and then destroy the lock on the appliance door.

Warning **Risk of suffocation!**

If allowed to play with the packaging/plastic film or packing components, children may become caught in these or pull them over their heads and suffocate.

Keep packaging, plastic film and packing components away from children.

⚠ Warning

Risk of poisoning!

Detergents and care products may result in poisoning if consumed.

If accidentally swallowed, seek medical advice. Keep detergents and care products out of the reach of children.

⚠ Warning

Eye/skin irritation!

Contact with detergents or care products may cause eye/skin irritation.

Rinse eyes/skin thoroughly if they/it come(s) into contact with detergents or care products. Keep detergents and care products out of the reach of children.

Installation

⚠ Warning

**Risk of electric shock/fire/
material damage/damage to
the appliance!**

If the appliance is not installed properly, this may lead to a dangerous situation. Ensure the following:

- The mains voltage on your power socket must match the rated voltage specified on the appliance (identification plate). The connected loads and the required fuse protection are specified on the identification plate.

- The mains plug and the protective contact socket must match and the earthing system must be correctly installed.
- The installation must have an adequate cross section.
- The mains plug must be freely accessible at all times. If this is not possible, in order to comply with the relevant safety regulations, a switch (all pole disconnection) must be built into the permanent installation in accordance with electrical installation regulations.
- If using a residual current circuit breaker, only use one that bears the following mark: . The presence of this mark is the only way to be sure that it fulfils all the applicable regulations.

⚠ Warning

**Risk of electric shock/fire/
material damage/damage to
the appliance!**

If the appliance's mains cable is altered or damaged, this may result in electric shock, short circuiting or fire due to overheating.

The mains cable must not be kinked, crushed or altered, and must not come into contact with any heat sources.

⚠ Warning**Risk of fire/material damage/
damage to the appliance!**

The use of extension cords or power strips may result in fire due to overheating or short circuiting.

Connect the appliance directly to an earthed socket that has been correctly installed. Do not use extension cords, power strips or multi-way couplers.

⚠ Warning**Risk of injury/material
damage/damage to the
appliance!**

- The appliance may vibrate or move when in operation, potentially resulting in injury or material damage. Place the appliance on a clean, even, solid surface and, using a spirit level to guide you, level it with the screw-in feet.
- If you take hold of any of the appliance's protruding parts (e.g. the appliance door) in order to lift or move it, these parts may break off and cause injury. Do not take hold of any of the appliance's protruding parts in order to move the appliance.

⚠ Warning**Risk of injury!**

- The appliance is very heavy. Lifting it may result in injury. Do not lift the appliance on your own.

- The appliance has sharp edges on which you could cut your hands. Do not take hold of the appliance by its sharp edges. Wear protective gloves to lift it.
- If the hoses and mains cables are not correctly routed, they may constitute a tripping hazard, which may result in injury. Route hoses and cables such that they do not constitute a tripping hazard.

Caution!**Material damage/damage to
the appliance**

- If the water pressure is too high or too low, the appliance may not be able to operate properly, and it may also result in material damage or damage to the appliance. Make sure that the water pressure in the water supply facility is at least 100 kPa (1 bar), and does not exceed 1000 kPa (10 bar).
- If the water hoses are altered or damaged, this may result in material damage or damage to the appliance. The water hoses must not be kinked, crushed, altered or severed.

- The use of hoses supplied by other brands to connect to the water supply may result in material damage or damage to the appliance. Use the hoses supplied with the appliance or genuine spare part hoses only.
- The appliance is secured for transportation by transport locking devices. If the transport locking devices are not removed before the appliance is operated, this may result in damage to the appliance.

It is important to completely remove all transport locking devices before using the appliance for the first time. Make sure that you retain these transport locking devices separately. It is important to refit the transport locking devices if the appliance is to be transported, in order to prevent the appliance from being damaged in transit.

Operation

Warning **Risk of explosions/fire!**

Laundry that has come into contact with solvents, oil, wax, wax remover, paint, grease or stain remover may ignite when dried in the machine, or even cause the appliance to explode. Therefore please note:

- Rinse the laundry thoroughly with warm water and detergent before drying it in the machine.
- Do not place laundry in this appliance to be dried if the laundry has not been washed first.
- Do not use the appliance if industrial chemicals have been used to clean the laundry.

Warning **Risk of explosions/fire!**

- Laundry that has been pretreated with cleaning agents that contain solvents, e.g. stain remover/cleaning solvent, may cause an explosion in the drum. Rinse the laundry thoroughly with water before washing it in the machine.
- Certain objects may ignite when drying is in progress, or even cause the appliance to catch fire or explode. Remove any lighters or matches from pockets on items of clothing.
- If there is coal dust or flour in the air around the appliance, this may cause an explosion. Make sure that the area around the appliance is kept clean when it is in operation.

Warning **Risk of fire/material damage/ damage to the appliance!**

If a program is terminated before the drying cycle has

finished, this prevents the laundry from cooling down sufficiently and may cause the laundry to ignite, or may result in material damage or damage to the appliance.

- During the last part of the drying cycle, the laundry in the drum is not heated (cooling cycle). This is to ensure that it remains at a temperature at which it will not be damaged.
- Do not switch off the appliance before the drying cycle has finished unless you remove all items of laundry from the drum immediately and spread them out (to dissipate the heat).

 **Warning**
Risk of poisoning!

Poisonous fumes may be given off by cleaning agents that contain solvents, e.g. cleaning solvent.

Do not use cleaning agents that contain solvents.

 **Warning**
Risk of injury!

- If you support your weight/sit on the appliance door when it is open, the appliance may tip over, which may result in injury.
Do not support your weight on the appliance door when it is open.

- If you climb onto the appliance, the worktop may break, which may result in injury.
Do not climb onto the appliance.
- If you reach into the drum while it is still rotating, you risk injuring your hands.
Wait until the drum has stopped rotating.

 **Warning**
Risk of scalding!

When washing at high temperatures, there is a risk of scalding if you come into contact with hot detergent solution (e.g. when draining hot detergent solution into a washbasin).
Do not reach into the hot detergent solution.

 **Warning**
Eye/skin irritation!

Detergent and care products may spray out if the detergent drawer is opened while the appliance is in operation.
Rinse eyes/skin thoroughly if they/it come(s) into contact with detergents or care products. If accidentally swallowed, seek medical advice.

Caution!

Material damage/damage to the appliance

- If the amount of laundry in the appliance exceeds its maximum load capacity, it may not be able to operate properly, or this may result in material damage or damage to the appliance.
Do not exceed the maximum load capacity of dry laundry. Make sure you comply with the maximum load capacities specified for each of the programs.
- Foam and foam rubber may deform or melt if dried in the appliance.
Do not dry laundry items that contain foam or foam rubber in the appliance.
- If you pour the wrong quantity of detergent or cleaning agent into the appliance, this may result in material damage or damage to the appliance.
Use detergents/care products/cleaning agents and softeners in accordance with the manufacturers' instructions.

Cleaning/Maintenance

Warning **Risk of death!**

The appliance is powered by electricity. There is a risk of electric shock if you come into contact with live components. Therefore please note:

- Switch off the appliance. Disconnect the appliance from the power supply (pull out the plug).
- Never take hold of the mains plug with wet hands.
- When removing the mains plug from the socket, always take hold of the plug itself and never the mains cable, otherwise this may damage the mains cable.
- Do not make any technical modifications to the appliance or its features.
- Repairs and any other work on the appliance must only be conducted by our customer service or by an electrician. The same applies for replacing the mains cable (when necessary).
- Spare mains cables can be ordered from our customer service.

Warning **Risk of poisoning!**

Poisonous fumes may be given off by cleaning agents that contain solvents, e.g. cleaning solvent.
Do not use cleaning agents that contain solvents.

Warning **Risk of electric shock/material damage/damage to the appliance!**

If moisture penetrates the appliance, this may cause it to short circuit.

Do not use a pressure washer, steam cleaner, hose or spray gun to clean your appliance.

Warning

Risk of injury/material damage/damage to the appliance!

The use of spare parts and accessories supplied by other brands is dangerous and may result in injury, material damage or damage to the appliance. For safety reasons, use genuine spare parts and accessories only.

Caution! **Material damage/damage to the appliance**

Cleaning agents and agents for pretreating laundry (e.g. stain removers, prewash sprays, etc.) may cause damage if they come into contact with the surfaces of the appliance. Therefore please note:

- Do not allow these agents to come into contact with the surfaces of the appliance.
- Clean the appliance with nothing but water and a soft, damp cloth.
- Remove any detergent, spray or other residues immediately.



Environmental protection

Packaging/used appliance



Dispose of packaging in an environmentally-responsible manner.

This appliance is labelled in accordance with European Directive 2012/19/EU concerning used electrical and electronic appliances (waste electrical and electronic equipment - WEEE).

The guideline determines the framework for the return and recycling of used appliances as applicable throughout the EU.

Tips on economical use

- Always fill the appliance with the maximum amount of laundry for each programme. → *Page 26*
- Wash normally soiled laundry without pretreating.
- For light and normal soiling in laundry, you can save energy and detergent.
- The selectable temperatures apply to the care labels on the textiles. The temperatures in the appliance may deviate from this so that you get the optimum mix of energy-saving and washing results.

- **Sleep mode:** If the appliance is not operated for a prolonged period (approx. 5 minutes), the display panel lighting goes out before the programme starts and after the programme has ended, ① flashes. Touch any area of display panel to activate the display backlighting. When the programme is running, most of the display panel lighting goes out. Touch any area of display panel to re-activate the lighting.
- **Automatic switch off:** If the appliance is not operated for a prolonged period (approx. 20 minutes), it will automatically switch off (depending on the water level inside of appliance) before the programme starts and after the programme has ended. Press the power button ① again to switch on the appliance.
- If the laundry is then dried in the appliance, select the maximum possible spin speed. The less water the laundry contains, the less time and energy are required for drying. Do not dry dripping wet laundry.



Positioning and connecting

Standard accessories

Note: Check the appliance for transport damage. Never use a damaged appliance. If you have any complaints, contact the dealer from whom you purchased the appliance or our Customer Service.

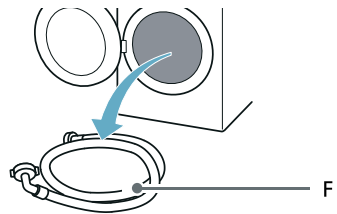
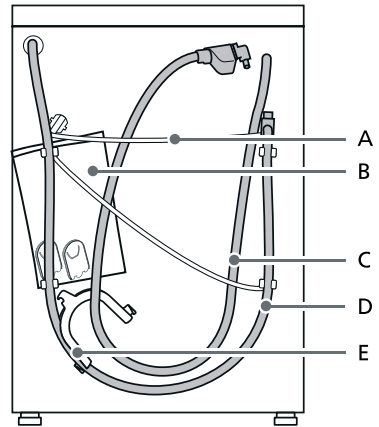

- A Mains lead
- B Bag:
 - Installation and operating instructions
 - Customer Service location directory*
 - Warranty*
 - Supplementary sheet for the installation and operating instructions*
 - Cover caps for openings after the transport braces have been removed
 - Home Connect Installation Guides*
- C Water inlet hose on aquaStop models
- D Water outlet hose
- E Elbow for securing the water outlet hose*
- F Cold water inlet hose on Standard/Aqua-Secure models
- * Depending on the model

In addition, a hose clamp (24 - 40 mm diameter, available from specialist retailers) is required to connect the water outlet hose to a siphon.

Useful tool

- Spirit level for aligning
- Wrench with:
 - WAF13 for loosening the transport braces and
 - WAF17 for aligning the appliance feet

Safety instructions



Warning

Risk of injury!

- The appliance is very heavy. Be careful when lifting/transporting the appliance.
- When the appliance is lifted by its protruding parts (e.g. the appliance door), the components may break off and cause injuries. Do not lift the appliance by protruding parts.

- If the hose and mains cables are not routed properly, there is a risk of tripping and injury. Lay hoses and cables in such a way that there is no risk of tripping.

Caution!

Damage to the appliance

Frozen hoses may rip/burst. Do not install the appliance in areas exposed to frost or outdoors.

Caution!

Water damage

The connection points for the water supply hose and water drain hose are under high water pressure. To prevent leaks and water damage, you must follow the instructions in this section.

Notes

- In addition to the safety information listed here, the local water and electricity supplier may have special requirements.
- If in doubt, have the appliance connected by a specialist.

Installation surface

Note: The appliance must be stable aligned so that it does not move around.

- The installation surface must be firm and level.
- Soft floors/floor coverings are not suitable.

Installation on a base or a wooden joist floor

Caution!

Damage to the appliance

The appliance may "wander" and tip/topple from the base when spinning. The feet of the appliance must be secured with holding brackets. Order no. WMZ 2200, WX 975600, CZ 110600, Z 7080X0.

en Positioning and connecting

Note: On wooden joist floors, install the appliance:

- In a corner, if possible,
- On a water-resistant wooden board (min. 30 mm thick) which is screwed tightly to the floor.

Installing the appliance in a kitchenette

Warning **Risk of death!**

There is a risk of electric shock if you touch live components.
Do not remove the appliance covering plate.

Notes

- Recess width of 60 cm required.
- Only install the appliance underneath a continuous worktop that is securely connected to adjacent cabinets.

Removing the transport locks

Caution! **Damage to the appliance**

- The appliance is secured for transportation using transport locks. If the transport locks are not removed, the appliance may become damaged when it is operated.
Before using the appliance for the first time, make sure that you completely remove all four transport locks. Keep the locks in a safe place.
- To prevent transport damage from occurring if the appliance is moved at a later date, you must refit the transport locks before transporting the appliance.

Note: Keep the screws and sleeves in a safe place.

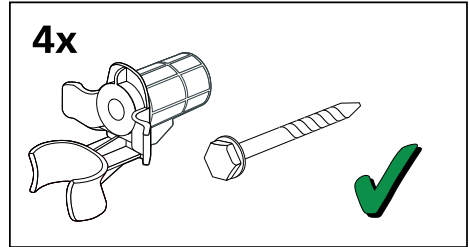

1. Take the hoses out of the holders.

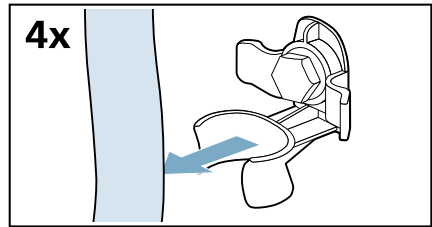

2. Unscrew and remove all four transport brace screws.

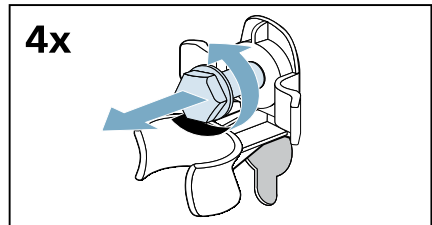

- a) Remove the mains cable from the holders.

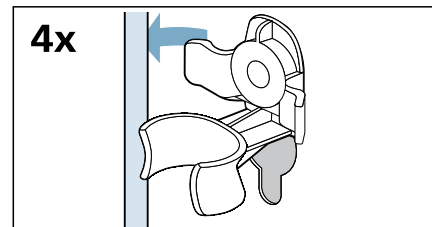

b) Remove the sleeves.

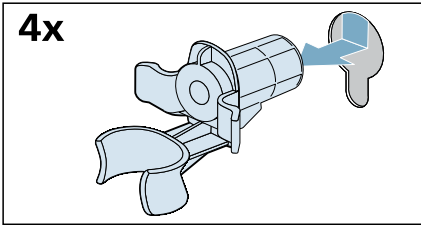

3. Fit the covers.

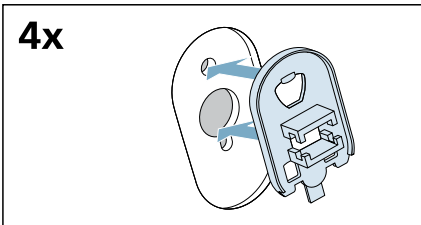

4. Lock the covers firmly in place by applying pressure to the snap-in hooks.

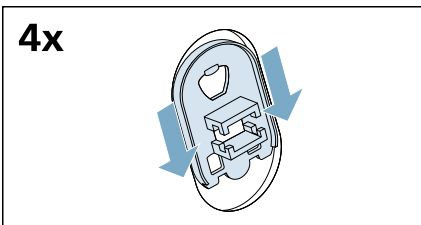

Hose and cable lengths

Connection on left side

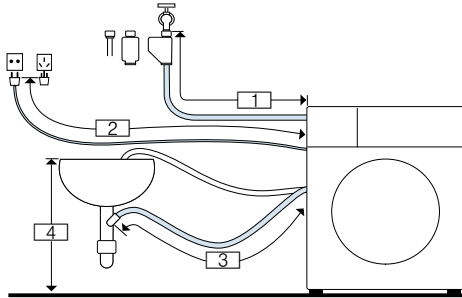

- 1 ~ 105 cm
- 2 ~ 150 cm
- 3 ~ 95 cm
- 4 0 cm ~ 100 cm

or

Connection on right side

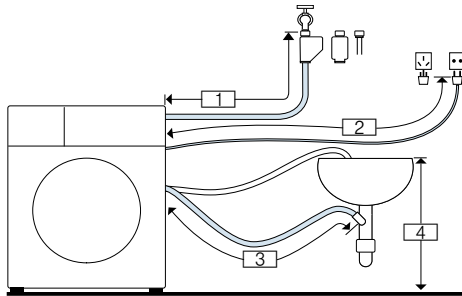

- 1 ~ 60 cm
- 2 ~ 195 cm
- 3 ~ 140 cm
- 4 0 cm ~ 100 cm

Note: If the supply hose is too short for your connection, you can order an extension from the after-sales service.

Water inlet

Warning **Risk of death!**

There is a risk of electric shock if you touch live components. Do not immerse the Aqua-Stop safety valve* in water (it contains an electric valve).

* Depending on the model

Observe the following when connecting the appliance:

Notes

- Only operate the appliance using cold mains water.
- Do not connect the appliance to the mixer tap of an unpressurised hot-water boiler.
- Do not use a used supply hose. Only use the supply hose supplied or one that was purchased from an authorised specialist retailer.
- Do not bend, squash, modify or cut through the water supply hose (otherwise its strength is no longer guaranteed).
- Only tighten the screw connections by hand. If the screw connections are tightened too much with a tool (pliers), the thread may be damaged.

Optimum water pressure in the supply network

At least 100 kPa (1 bar)

Maximum 1000 kPa (10 bar)

When the tap is open, the water flow is at least 8 l/min.

If the water pressure is higher than this, a pressure-reducing valve must be installed.

Connection

1. Connect the water supply hose to the water tap ($\frac{3}{4}$ " = 26.4 mm) and to the appliance:

– Model: **Standard**

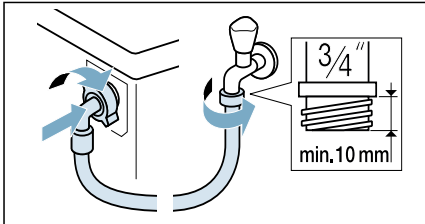

– Model: **Aqua-Secure**

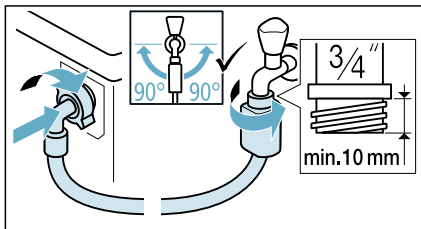

– Model: **Aqua-Stop**

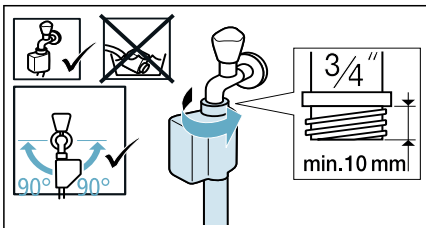

Tip: Connect also an external water filter (depending on the model) between water supply hose and tap. The filter filters dirt particles out of the water.

Water filter must be cleaned regularly to remove contaminants. This will prevent blockages. See also → separate installation and cleaning instruction for water filter.

2. Open the water tap carefully, checking the leak tightness of the connection points. The screw connection is under mains water pressure.

Water outlet

Warning **Risk of scalding!**

When you are washing at high temperatures, there is a risk of scalding if you come into contact with hot water (e.g. when draining hot water into a washbasin).

Do not reach into the hot water.

Caution! **Water damage**

When water is being pumped away, the outlet hose is under water pressure and may slip out of the wash basin or connection point.

Secure the drain hose so that it cannot slip out.

Caution! **Damage to the appliance/fabrics**

If the end of the drain hose is immersed in the drained water, water may be sucked back into the appliance and may damage the appliance/fabrics. Make sure that:

- The plug does not block drainage from the washbasin.
- The end of the drain hose is not immersed in the drained water.
- The water drains away quickly enough.

Note: Do not kink the water drain hose or put strain on it lengthways.

Connection

■ Drainage into a siphon

The connection point must be secured using a hose clamp with a diameter of 24 - 40 mm (available from specialist dealers).

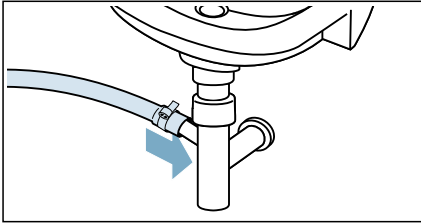

■ Drainage into a washbasin

Secure the outlet hose so that it cannot slip out. Elbow available from after-sales service: Individual part number 00655300

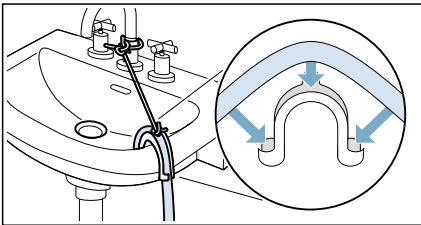

■ Drainage into a plastic pipe with rubber bushing or into a drainage pit

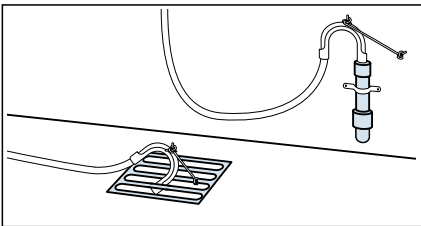

Note: The plastic pipe is not standard accessory, available from specialist dealers.

Alignment

Level the appliance using a spirit level. Incorrect levelling may result in intense noise, vibrations and "wandering".

1. Loosen the lock nuts using a wrench, by turning it in a clockwise direction.

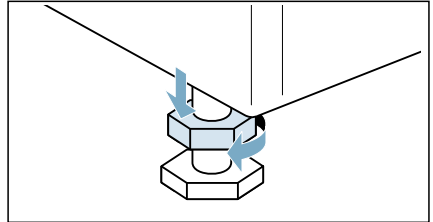

2. Check the alignment of the appliance with a spirit level, and adjust it if necessary. Change the height by turning the appliance feet. All four appliance feet must stand firmly on the ground.

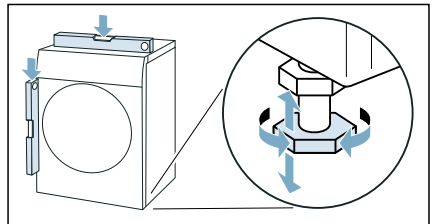

3. Tighten the lock nut against the housing. In doing so, hold the foot tight and do not adjust its height. The lock nuts on all four appliance feet must be screwed tightly against the housing.

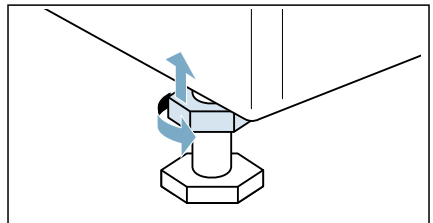

Electrical connection

Warning

Risk of death!

There is a risk of electric shock if you touch live components.

- Never touch or hold the mains plug with wet hands.
- Only pull out the mains cable by the plug and never by the cable, as this could damage it.

Observe the following information and ensure that:



Notes

- The mains voltage and voltage indicated on the appliance (rating plate) are the same. The connected load and fuse required are specified on the rating plate.
- The appliance is only connected to an alternating current via a properly installed earthed socket.
- The mains plug fits the socket.
- The earthing system is properly installed.
- The mains cable is only replaced by a qualified electrician (if this is necessary). Replacement mains cables are available from the after-sales service.
- No multiple plugs/couplings or extension cables are used.
- If an earth-leakage circuit breaker is used, only a type which displays this symbol is used: . Only this symbol guarantees compliance with the currently applicable regulations.
- The mains plug can be accessed at all times.
- The mains cable is not bent, squashed, modified, cut through, or in contact with heat sources.

Before washing for the first time

The appliance was inspected thoroughly before leaving the factory. To remove any residual test water, run the **Drum clean** programme the first time **without** laundry.

Note:

- The appliance must have been installed and connected properly. → *"Positioning and connecting" on page 12*
 - Never switch on a damaged appliance.
1. Insert mains plug.
 2. Turn the water tap on.
 3. Press the  button till the indicator lamp lights up, release the button. The appliance is switched on.
 4. Close the door. Do not load any laundry.
 5. Select the **Drum clean 90° C** programme.
 6. Open the detergent drawer.
 7. Pour approx. 1 litre of water into dispenser **II**.
 8. Add standard detergent to dispenser **II** according to manufacturer's instructions for light soiling.
- Note:** To prevent over sudsing, use only half the recommended amount of detergent. Do not use any woollens or mild detergents.
9. Close the detergent drawer.
 10. Select .
 11. When the programme ends, press the  button till the indicator lamp turns off, release the button.

Your appliance is now ready for use.

Transportation

e.g. when moving home

Preparatory work:

1. Turn off the water tap.
2. Reduce the water pressure in the supply hose. → *Page 42*
3. Drain any residual water.
→ *Page 41*
4. Disconnect the appliance from the mains.
5. Remove the hoses.
6. Empty the dispensers.
→ *"Detergent drawer and housing"*
on page 40

Installing the transport locks:

1. Remove the covers and keep them in a safe place.

Note: Use a screwdriver if necessary.

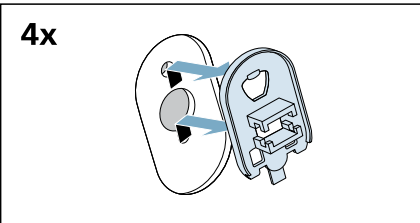
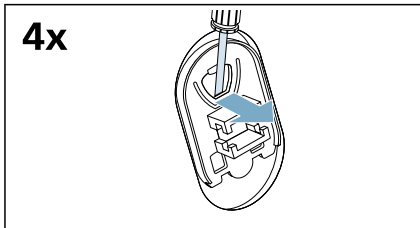

2. Insert all four sleeves.

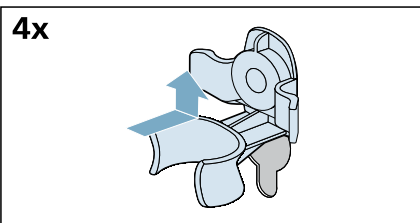

- a) Clip the mains cable securely in the holders.

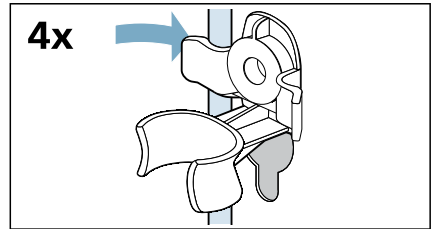

- b) Insert and tighten the screws.

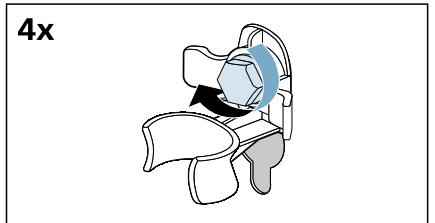

- c) Clip the hoses securely in the holders.

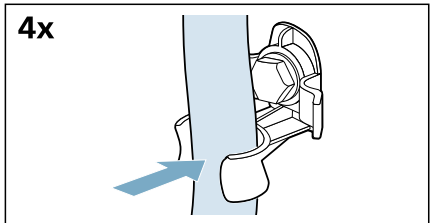

Before switching on the appliance again:

Notes

- The transport braces **must** be removed.
→ *"Removing the transport locks"*
on page 14
- Pour approx. 1 litre of water into dispenser **II**, select the **Empty** programme and start.
This will prevent detergent from flowing straight into the drain during the next wash.

Getting to know the appliance

Appliance

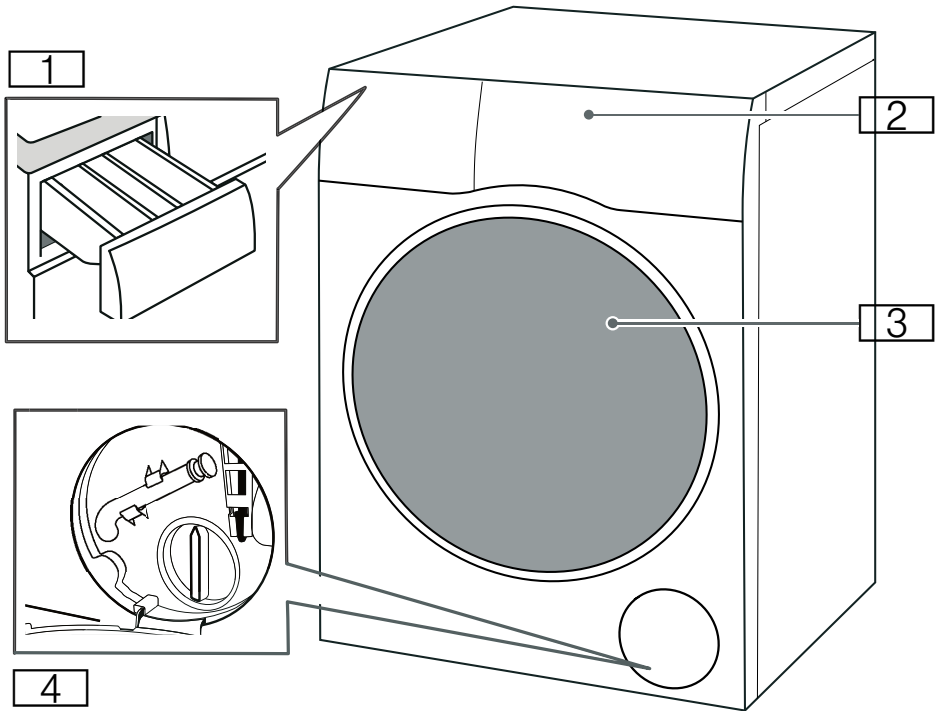

- 1** Detergent drawer
- 2** Control panel
- 3** Loading door
- 4** Service flap

Control panel

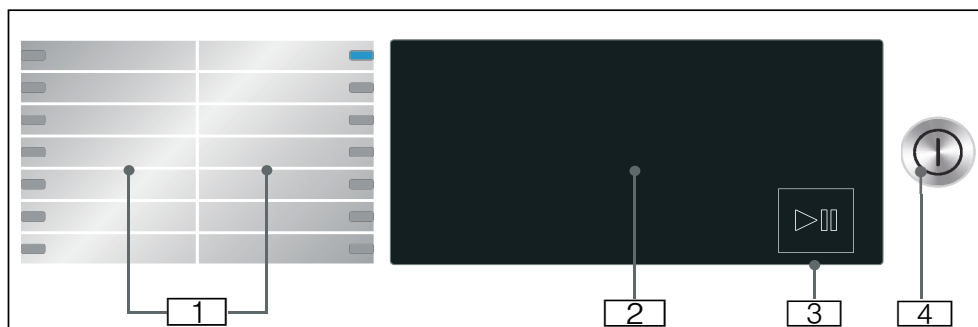

- 1** Programmes that can be selected.
- 2** Touch-Display
- 3** Start/Pause button
Touch ▶|| button to start, interrupt (e.g. reload washing) and cancel the programme.
- 4** Power button
Press the ⓐ button to switch the appliance on/off.

Touch-Display

Programme default settings

90°	1400	
60°	1200	
40°	800	
30°	600	
20°	400	
❄️	🌀	

Display	Setting	Description
❄️ - 90°	Temperature	Temperature that can be set in °C ❄️ = cold
🌀, 400-1400*	Spin speed	Spin speed in rpm (revolutions per minute) 🌀 = No spin
2:30*	Programme remaining time	Programme remaining time depends on the programme selection in h:min (hours:minutes)
0.5 - 24 h	"Finish in" time	Programme ends after ... h (h = hours)
10.0* kg/ 6.0* kg	Maximum load for Washing/Dry-ing	Recommended load in kg
* Depending on the selected model and programme.		

Additional programme settings



Display	Setting
Wash+Dry	
Dry	
🗄️+ (Cupboard dry+)	
🗄️ (Cupboard dry)	
🧻 (Iron dry)	
⏴ (Prewash)	→ "Additional programme settings" on page 32
🧺 (Rinse plus)	
🧺 (Easy iron)	
🧺 (Water plus)	
⚙️ Speed	
🌿 Eco	
★ (Memory)	
🔇 (Silent)	

Status indicators for the programme progress (programme sequence)

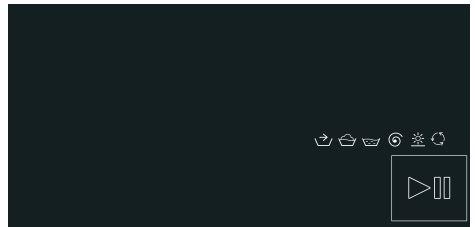

Display	Setting
▶️⏸️	Start/Pause button
🧺	Pretreatment
🧺	Wash
🧺	Rinse
🌀	Spin/Drain
❄️	Dry
🔄	Wrinkle guard
End	Programme end



Laundry

Preparing laundry for washing

Protecting your laundry and appliance

Caution!

Damage to the appliance/textiles

Foreign objects (e.g. coins, paper clips, needles, nails) may damage the washing or components of the appliance.

The following instructions must be observed when preparing your laundry:

- Always follow the manufacturer's instructions when dosing all detergents, cleaning aids, care products and cleaning agents.
- Do not exceed maximum load. Overfilling will impair the washing result.
- Keep detergents and agents for the pretreatment of laundry (e.g. stain remover, prewash sprays, etc.) away from the surfaces of the appliance. Using a damp cloth, immediately remove any fine spray residue and other residue or droplets.
- Empty any pockets. Remove any foreign objects.
- Remove metal parts (paper clips, etc.).
- Trousers, knitwear and knitted textiles, e.g. jersey garments, T-shirts or sweatshirts, should be turned inside out.
- Ensure that underwired bras are appliance-washable.
- Wash delicates in a net or bag (tights, underwired bras, etc).
- Close zips, button up covers.
- Brush sand out of pockets and collars.
- Remove curtain fittings or place in a net/bag.

Sorting laundry

Sort your laundry according to the care instructions and manufacturer's information on the care labels, depending on:

- Type of fabric/fibre
- Colour
- **Note:** Laundry may discolour. Wash white and coloured items separately. Wash new coloured items separately the first time you wash them.
- Soiling
 - Wash laundry with the same level of soiling together. Some examples of soiling levels can be found in the chapter
 - **Light:** Do not need to pretreat, adjust the  **Speed** setting if necessary.
 - **Normal**
 - **Heavy:** Load less laundry, need to pretreat or soak laundry firstly.
 - **Stains:** Remove/pretreat stains while they are fresh. First dab with soapy water; do not rub. Then wash the items of laundry with the appropriate programme. Stubborn or dried-in stains can sometimes only be removed by washing several times.
- Symbols on the care labels



Suitable for normal washing process;

e.g. Cottons programme



A gentle washing process is required;

e.g. Easy-Care programme



An especially gentle washing process is required;

e.g. Delicates/

Silk programme



Suitable for washing by hand; e.g. Wool  programme





Do not machine wash.

Preparing laundry for drying

Note: To ensure an even drying result, sort the laundry according to the:

- Type of fabric
- Care symbols which are indicated on the care labels.

Only dry laundry which is labelled “dryer-proof” or which has the following care symbols:

-  : You can select **Cottons/Towels/Hygiene/myTime + Dry**
-  : You can select **Easy-Care/Mix/Wool /Shirts/Business + Dry**

The following textiles should not be dried:

-  = care symbol “Do not dry”
- Delicates (silk, synthetic curtains).
- Textiles which contain foam rubber or similar materials.
- Textiles which were treated with flammable liquids, e.g. with stain remover, petroleum ether, thinners. Risk of explosion!
- Textiles which still contain hairspray or similar substances.

Notes

- Before drying, hand-washed textiles must be spun at the appropriate spin speed.
- Before drying, spin at the optimum speed. A spin speed of more than 1000 rpm is recommended for cotton, more than 800 rpm for easy-care textiles.
- Do not iron washing immediately after drying. It is recommended to roll the washing up first to distribute residual moisture evenly.
- To ensure a good drying performance, quilts, terry cloths and other large textiles should be dried separately. Do not dry more than 6 terry cloths (or 5 kg).
- Do not exceed the maximum load.

Overview of programmes

Selectable programme







Programme/Type of laundry	Options/Information
<p>Name of the programme</p> <p>Brief explanation of the programme and for which fabrics it is suitable.</p>	<p>Max. load for washing/ Max. load for drying</p> <p>Max. load as kg depending on the model and the programme</p> <p>selectable temperature* as °C</p> <p>selectable spin speed* in rpm</p> <p>possible additional programme settings*</p>
<p>Cottons</p> <p>Hard-wearing fabrics, heat-resistant fabrics made of cotton or linen.</p>	<p>10.0 (5.0**) kg/6.0 kg</p> <p>✳ - 90 °C</p> <p>400 - 1400 rpm</p> <p>≡⌚ Speed, ⌚ Eco, ⌚ (Water plus), ✂ (Easy iron), ⌚ (Rinse plus), ⌚ (Pre-wash), ☆ (Memory), ⌚ (Silent), Wash+Dry, Dry, ⌚+ (Cupboard dry+), ⌚ (Cupboard dry), ⌚ (Iron dry)</p>
<p>Easy-Care</p> <p>Textiles made of synthetic materials or blended fabrics.</p>	<p>4.0 kg/2.5 kg</p> <p>✳ - 60 °C</p> <p>400 - 1400 rpm</p> <p>≡⌚ Speed, ⌚ Eco, ⌚ (Water plus), ✂ (Easy iron), ⌚ (Rinse plus), ⌚ (Pre-wash), ☆ (Memory), ⌚ (Silent), Wash+Dry, Dry, ⌚+ (Cupboard dry+), ⌚ (Cupboard dry), ⌚ (Iron dry)</p>
<p>Mix</p> <p>Mixed load of cottons and synthetic fabrics.</p>	<p>4.0 kg/2.5 kg</p> <p>✳ - 40 °C</p> <p>400 - 1400 rpm</p> <p>≡⌚ Speed, ⌚ Eco, ⌚ (Water plus), ✂ (Easy iron), ⌚ (Rinse plus), ⌚ (Pre-wash), ☆ (Memory), ⌚ (Silent), Wash+Dry, Dry, ⌚+ (Cupboard dry+), ⌚ (Cupboard dry), ⌚ (Iron dry)</p>
<p>* Depending on the model and the programme. ** Reduced load with ≡⌚ Speed additional programme setting.</p>	

Programme/Type of laundry	Options/Information
<p>Delicates/Silk</p> <p>For delicate, washable fabrics, e.g. made of silk, satin, synthetic fibres or blends (e.g. silk blouses, silk scarves).</p>	<p>2.0 kg/-</p> <p>❄ - 40 °C</p> <p>🌀 - 800 rpm</p> <p>⌚ Speed, 🌿 Eco, 🚰 (Water plus), 🧺 (Easy iron), 🚰 (Rinse plus), ⏴ (Pre-wash), ☆ (Memory), 🗨 (Silent)</p>
<p>Wool 🐑</p> <p>Hand- or appliance-washable fabrics that are made of wool or contain wool;</p> <p>particularly gentle wash programme to prevent laundry from shrinking, with longer pauses in the programme (during which the items rest in the water).</p> <p>Note: In order to prevent clothing shrink, after drying still contain a small amount of water, please take out the clothes as soon as possible after the end of the programme to flat dry.</p>	<p>2.0 kg/1.0 kg</p> <p>❄ - 40 °C</p> <p>🌀 - 800 rpm</p> <p>☆ (Memory), 🗨 (Silent), Wash+Dry, Dry, 🗄 (Iron dry)</p>
<p>Towels</p> <p>For hygienic cleaning of terry cloth textiles, such as towels and bathrobes. Adjusted spinning for optimal washing and soft to touch results.</p>	<p>3.5 kg/3.5kg</p> <p>❄ - 90 °C</p> <p>400 - 1400 rpm</p> <p>⌚ Speed, 🌿 Eco, 🚰 (Water plus), 🧺 (Easy iron), 🚰 (Rinse plus), ⏴ (Pre-wash), ☆ (Memory), 🗨 (Silent), Wash+Dry, Dry, 🗄+ (Cupboard dry+), 🗄 (Cupboard dry)</p>
<p>Rinse/Spin/Empty</p> <p>Combined extra programme for rinsing and spinning the laundry, and draining the rinsing water</p> <p>Note: The setting 🚰 (Rinse plus) is activated at the factory for this programme.</p> <p>If you only want to spin the laundry: Deactivate the 🚰 (Rinse plus) setting and, if required, adjust the spin speed.</p> <p>If you only want to drain water: Deactivate the 🚰 (Rinse plus) setting and select the 🌀 setting.</p>	<p>-</p> <p>-</p> <p>🌀 - 1400 rpm</p> <p>🧺 (Easy iron), 🚰 (Water plus), 🚰 (Rinse plus), ☆ (Memory), Wash+Dry, 🗄+ (Cupboard dry+), 🗄 (Cupboard dry), 🗄 (Iron dry)</p>
<p>* Depending on the model and the programme.</p> <p>** Reduced load with ⌚ Speed additional programme setting.</p>	

Programme/Type of laundry	Options/Information
<p>Drum clean</p> <p>Special programme for drum hygiene or fluff removal. Do not load any laundry.</p> <p>90°C = antibacterial programme. 40°C = antibacterial programme, special drum cleaning detergent can be used.</p> <p>✳ = no antibacterial programme, to remove hair or fluff from the tub.</p> <p>The Drum clean programme indicator flashes if you have not used any programme at a temperature of 60 °C or higher for an extended period.</p> <p>Notes</p> <ul style="list-style-type: none"> Switching the Drum clean information signal on/off. → "Switching the drum-care information signal on/off" on page 39 Always follow the manufacturer's instructions when dosing the detergent. 	<p>0.0 kg/0.0 kg</p> <p>✳, 40°C, 90 °C</p> <p>1200 rpm</p> <p>☆ (Memory), 🚫 (Silent)</p>
<p>Hygiene</p> <p>Hard-wearing fabrics made of cotton or linen.</p> <p>Note: Particularly suited to washing items that need to be hygienically clean and especially kind to sensitive skin thanks to the longer wash cycle at a defined temperature, higher water level and longer spin cycle.</p>	<p>6.5 kg/5.0 kg</p> <p>✳ - 60 °C</p> <p>400 - 1400 rpm</p> <p>⌚ Speed, 🌿 Eco, 🚰 (Water plus), 🧺 (Easy iron), 🚰 (Rinse plus), ⏴ (Pre-wash), ☆ (Memory), 🚫 (Silent), Wash+Dry, Dry, 🗄️* (Cupboard dry+), 🗄️ (Cupboard dry), 🧺 (Iron dry)</p>
<p>Outdoor/Waterproofing</p> <p>Wash cycle followed by waterproofing of membrane-coated weatherproof and outdoor clothing or water-resistant fabrics</p> <p>Notes</p> <ul style="list-style-type: none"> Use special detergent that is suitable for machine washing; add the correct dosage to the dispenser II in accordance with the manufacturer's instructions. Add the dosage of waterproofing agent (max. 170ml) to the dispenser 🧴. Laundry must not be treated with fabric softener. Before washing, thoroughly clean the detergent drawer. It is recommended that you pull down the zipper before washing and turn the inner layer inside out. 	<p>1.0 kg/1.0 kg</p> <p>✳ - 40 °C</p> <p>400 - 800 rpm</p> <p>⌚ Speed, 🌿 Eco, 🚰 (Water plus), 🚰 (Rinse plus), ☆ (Memory), 🚫 (Silent), Wash+Dry, Dry, 🗄️ (Cupboard dry)</p>
<p>* Depending on the model and the programme. ** Reduced load with ⌚ Speed additional programme setting.</p>	

Programme/Type of laundry	Options/Information
<p>Shirts/Business</p> <p>Non-iron shirts or blouses made of cotton, linen, synthetic fibres or blended fabrics.</p>	<p>2.0 kg/2.0 kg</p> <p>❄ - 60 °C</p> <p>400 - 800 rpm</p> <p>≡⌚ Speed, 🌿 Eco, 🚰 (Water plus), 🧺 (Easy iron), 🚰 (Rinse plus), ⏸ (Pre-wash), ☆ (Memory), 🚰 (Silent), Wash+Dry, Dry, 🗄 (Cupboard dry), 🚰 (Iron dry)</p>
<p>Refresh</p> <p>Odor removal and wrinkle reduction program, suitable for wool, linen, suits, etc. which do not need frequent washing.</p> <p>Notes</p> <ul style="list-style-type: none"> It is recommended to hang the clothing in a ventilated environment for 3-5mins after program finished. In case of continuously using the refresh program, it is recommended to run a washing cycle between each refresh program cycle to remove odor from the appliance. The detergent can not be added for this programme. 	<p>-/1.0 kg</p> <p>-</p> <p>-</p> <p>☆ (Memory), 🚰 (Silent), Dry</p>
<p>myTime</p> <p>Mixed fabrics; for lightly soiled laundry made of cotton and synthetics.</p> <p>The length of the programme can be set each time. The maximum programme length is 60 minutes for washing and 120 minutes for drying, it can be reduced in 10-minute increments.</p> <p>Notes</p> <ul style="list-style-type: none"> Increase the length of the programme with 🚰 (Rinse plus) additional programme setting. The → (Finish in) programme default setting can not be selected for this programme. If you use this programme for drying, the detergent can not be added. 	<p>2.0 kg/6.0 kg</p> <p>❄ - 40 °C</p> <p>400 - 1200 rpm</p> <p>🚰 (Water plus), 🧺 (Easy iron), 🚰 (Rinse plus), ☆ (Memory), 🚰 (Silent), Dry, 🚰 (Iron dry)</p>
<p>Super 15'/Wash & Dry 60'</p> <p>For small amount lightly soiled garments made of cotton, linen, synthetic or blended fabrics. Approx. 15 mins for washing. If drying function is selected, it's followed by another approx. 45 mins drying process.</p> <p>Note: The default programme is Super 15'. You can switch to Wash & Dry 60' programme by touching Wash+Dry button.</p>	<p>2.0 kg/1.0 kg</p> <p>❄ - 40 °C</p> <p>400 - 1200 rpm</p> <p>☆ (Memory), 🚰 (Silent), Wash+Dry, 🗄 (Cupboard dry)</p>
<p>* Depending on the model and the programme. ** Reduced load with ≡⌚ Speed additional programme setting.</p>	



Drying table

Recommended drying programme	Option	Drying load (kg)	Estimated drying time (min)		
			 (Iron dry)	 (Cupboard dry)	 (Cupboard dry+)
Cottons/Towels/Hygiene	 Speed	1.0-2.0	40-50	50-70	65-90
		2.0-4.0	50-75	70-95	90-135
		4.0-6.0	75-90	95-120	135-160
	 Eco	1.0-2.0	45-65	60-90	75-110
		2.0-4.0	65-115	90-160	110-185
		4.0-6.0	115-150	160-240	185-265
Easy-Care/Mix/ Shirts/ Business	 Speed	0.5-1.5	30-40	35-60	45-80
		1.5-2.5	40-60	60-90	80-110
	 Eco	0.5-1.5	35-50	55-80	75-105
		1.5-2.5	50-75	80-120	105-145
Outdoor/Waterproofing		1.0	-	120	-

- i The time listed above is the reference value, the actual drying effect may be affected by the clothing type, clothing weight, dehydration degree and ambient temperature.
- i In order to achieve uniform drying effect, it is recommended to distinguish between heavy and light-weight clothing. For example, separate the thick towel and the shirt to bake.
- i  (Cupboard dry+) is recommended for drying bulky or heavy clothing.
- i In order to reduce the folding of clothing after drying, it is recommended to put a small amount of clothing drying.
- i Please refer to the panel display for the drying time of the programme not mentioned in the table above.

Starching

Note: Laundry should not be treated with fabric softener.

1. Switch on the appliance.
2. Select the **Rinse** programme.
3. Measure starch into compartment  in accordance with the manufacturer's instructions (clean first if necessary).
4. Touch the  button.

Dyeing/bleaching

Dye should only be used in normal household quantities. Salt may damage stainless steel. Always follow the dye manufacturer's instructions.

Do **not** use the appliance to bleach clothes.

P+ Programme default settings

You can change the default settings for selected programmes. The settings can be changed even while the selected programme is running. The effects depending on the progress of the programme.



Temperature

Before and after the programme starts, you can change the temperature setting, depending on what stage the programme is in, by adjusting the desired temperature on the display.

The maximum temperature that can be set depends on the programme that has been selected.

Spin speed

Depending on what stage the programme is in, you can change the spin speed (in rpm; revolutions per minute) before and during the programme by adjusting the desired speed on the display.

setting : ="No spin". The water is only drained.

You can select "No spin" to prevent creasing if the laundry will not be taken out of the appliance immediately after the programme has ended.

The maximum speed that can be set depending on the model and the programme that has been selected.

Finish in

Before starting the programme, you can preselect the programme end ("Finish in" time) in 0.5h increments (h = hour) up to a maximum of 24 hours.

To do this:

1. Select a programme (except **myTime** programme).
The programme duration is displayed for the selected programme, e.g. **2:30** (hours:minutes).
2. Select the **+** button repeatedly until the required number of hours is displayed.

Note: The setting values are increased using the **+** button, and decreased using the **-** button.

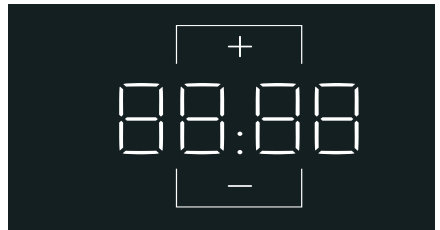

3. Select the **▷|||** button.
The programme starts.
The selected number of hours (e.g. **8h**) is shown in the display panel and counts down until the programme starts. The duration of the programme is then displayed.

Note: The length of the programme is automatically adjusted when the programme is running. Changes to the programme default settings or programme additional settings may also change the programme duration.

After starting the programme (if a "Finish in" time has been selected and the programme has not yet started), you can change the preselected number of hours as follows:

1. Select the **▷|||** button.
2. Touch the **+** or **-** button to change the number of hours.
3. Select the **▷|||** button.

Additional programme settings

Note: You can find possible additional programme settings in the overview; these differ depending on the model.

By selecting additional programme settings, you can better adapt the washing/drying process to your items of laundry.

The settings can be selected or deselected depending on the progress of the programme.

The button indicator lamps light up if a setting is activated.

The settings are not retained after the appliance is switched off.

Wash+Dry

Continuous cycle with washing and drying at once.

Dry

Drying cycle without washing.

(Cupboard dry)

For single-layer fabrics. Garments can be folded or hung up in a cupboard.

(Cupboard dry+)

For fabrics made of thick, multilayered items of clothing, which need to be dried longer. Garments can be folded or hung up in a cupboard. Laundry more dry than  (**Cupboard dry**).

(Iron dry)

Normal, single-layered laundry that still needs to be damp after drying and is suitable for ironing or hanging up.

Speed

Washing/drying in a shorter time while achieving a washing/drying result that is consistent with the normal performance.

Touch  **Speed** to activate or deactivate this additional programme setting.

Note: With the additional  **Speed** option activated, the maximum washing load will be reduced, and extra cooling water will be needed for the drying process.

Eco

Washing with less energy while achieving a washing result that is consistent with the normal performance. Drying with less water while achieving a drying result that is consistent with the normal performance.

Touch  **Eco** to activate or deactivate this additional programme setting.

Note: With the  **Eco** additional programme setting activated, washing at lower temperatures over a longer period of time to conserve washing performance; drying with less water over a longer period of time to achieve drying result.

(Prewash)

Prewash for heavily soiled laundry.

Touch  (**Prewash**) to activate or deactivate it.

Note: Put the detergent into dispenser I and II.

(Rinse plus)

Additional rinse cycle depending on the programme; longer programme length for particularly sensitive skin and/or for areas with very soft water.

(Easy iron)

Reduces creasing by means of a special spin sequence followed by fluffing and reduced spin speed.

Touch  (**Easy iron**) and activate or deactivate it.

Note: If  (**Easy iron**) has been activated, the laundry will have retained a higher than average level of moisture after spinning.

(Water plus)

Increased water level for gentler treatment of the laundry.

Touch  (**Water plus**) to activate or deactivate it.

☆ (Memory)

With memory you can save a selected programme with your favourite settings.

To store:

1. Switch on the appliance.
2. Select a programme.
3. If required, change the programme default settings and/or select programme additional settings.
4. Touch and hold ☆ (**Memory**) button for approx. three seconds.

The programme is saved if all of the settings flash briefly.

Calling up: touch ☆ (**Memory**) button briefly after you switch on the appliance.

Reset: touch and hold ☆ (**Memory**) button again for approx. three seconds after selecting the new programme and settings.

(Silent)

Function designed for noise reduction. Washing and drying process noise will be reduced, and ending signal will be switched off.

Note: If silent is selected for wash only, remaining moisture of the laundry will be slightly increased. The spin result may not be satisfying. Before hanging you can select **Spin** programme to further reduce moisture.



Operating the appliance

Preparing the appliance

The appliance was tested before delivery. To remove residual water from the test procedure, the first wash cycle should be run without laundry using the **Drum clean** programme.

→ "Before washing for the first time" on page 19

Notes

- Never switch on a damaged appliance!
- Inform customer service!

1. Insert mains plug.

Warning

Risk of death from electric shock!

Risk of death if live parts are touched.

- Never pull out the mains plug by tugging the power cord.
- Insert/pull out the mains plug with dry hands only.

en Operating the appliance

2. Turn the water tap on.

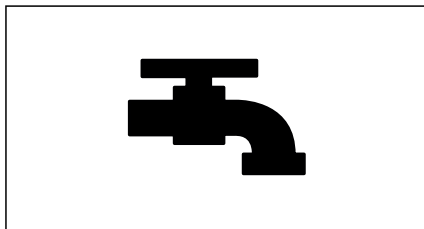

3. Open the appliance door.

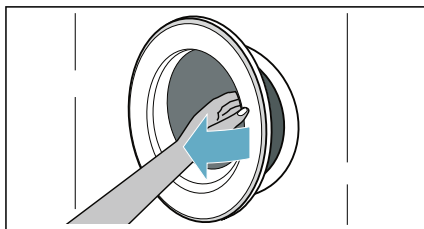

Placing laundry into the drum

Insert the laundry.

Close the door.

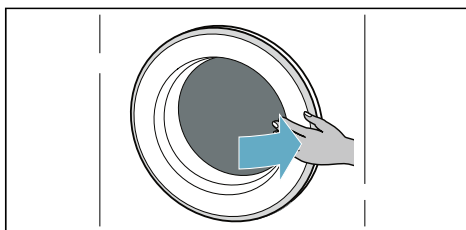
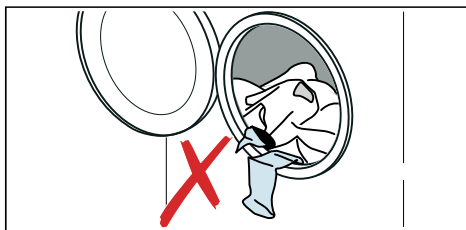

Switching on the appliance/ selecting a programme

Press the  button till the indicator lamp lights up, release the button. The appliance is switched on.

The **Cottons** programme, which is preset at the factory, is then always displayed.

You can use this programme or select a different programme.

Note: If you have activated the childproof lock, you must deactivate it before you can set a programme.

Presettings and maximum load are indicated on the Touch-Display for the selected programme.

You can use the displayed presettings or adjust the selected programme optimally to the items of washing by changing the → "Programme default settings" on page 31 and/or selecting → "Additional programme settings" on page 32.

Notes

- Unfold and load presorted items of laundry. Mix large and small items. Washing items of different size distribute themselves better during the spin cycle. Individual items of washing may cause an unbalanced load.
- Observe the maximum specified load. Overfilling adversely affects the washing/drying result and promotes creasing. Make sure that no items of laundry are trapped between the door and the rubber seal, and close the door.

Dosing and adding detergent and care products

Caution!

Damage to the appliance

Detergents and agents for the pretreatment of laundry (e.g. stain remover, prewash sprays, etc.) may damage the surfaces of the appliance. Keep these agents away from the surfaces of the appliance. Using a damp cloth, immediately remove any fine spray residue and other residue/droplets.

Dosing

Dose the detergents and care products according to:

- water hardness (ask your water supply company),
- the manufacturer's specifications on the packaging,
- the amount of laundry,
- soiling.

Filling the dispensers

1. Pull out the detergent drawer.



Warning

Eye / skin irritation!

If the detergent drawer is opened while the appliance is running, detergent/care product may run out. Carefully open the drawer. If detergent/care product comes into contact with eyes or skin, rinse thoroughly. If accidentally swallowed, seek medical advice.

2. Pour in detergent and/or cleaning product.

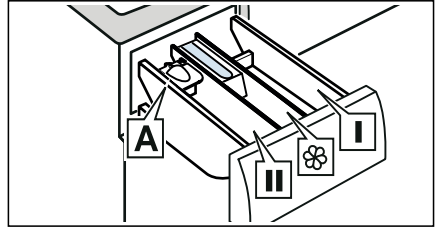

- | | |
|--------------|--|
| Dispenser I | Detergent for pretreat and clothing disinfectant. (only for the appliance with pretreat and disinfectant function) |
| Dispenser ☼ | Softener, starch. Do not exceed the maximum load. |
| Dispenser II | Detergent for main wash, water softener, bleach, stain remover. |
| Dispenser A* | For dosing liquid detergent. |

*depending on the model

Notes

- Always follow the manufacturer's instructions when dosing all detergents, cleaning aids, care products and cleaning agents.
- Dilute viscous fabric softener and fabric conditioner with water. This will prevent blockages.
- Be careful when opening the detergent drawer while the appliance is running.

Measuring aid A* for liquid detergent

*depending on the model

Position the measuring aid A for measuring the correct amount of liquid detergent:

1. Pull out the detergent drawer. Press down the insert and fully remove the drawer.

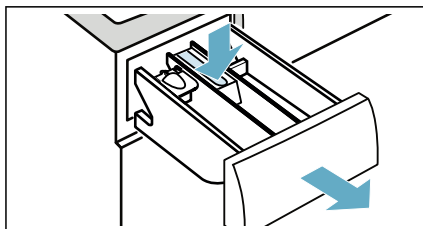

2. Slide the measuring aid forwards, fold it down and click it into place.

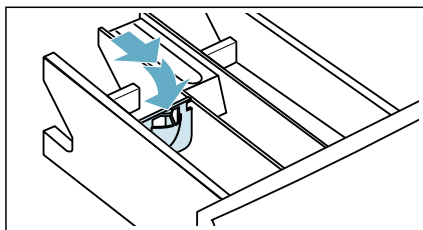

3. Reinsert the drawer.

Note: Do not use the measuring aid for gel detergents and washing powder, or for programmes with pretreat or when "Finish in" time is selected.

For models without a measuring aid, pour the liquid detergent into the appropriate dispenser and place it in the drum.

Starting the programme

Touch and hold ▷ button for 1~2 seconds, then release the button. The programme starts and the appliance door is locked.

The **Finish in** time is shown in the Touch-Display and counts down until the programme starts. After the programme has started, the programme duration is displayed. And the displays for the programme's progress light up. → "Touch-Display" on page 23

Note: Foam detection

If the symbol  also lights up in the Touch-Display, the appliance has detected too much foam during the wash cycle and automatically activated additional rinse cycles to remove the foam.

If you want to lock the programme to prevent it from being adjusted inadvertently, you can select the childproof lock.



Childproof lock



You can lock the appliance to prevent the functions you have set from being changed inadvertently. To do this, activate the childproof lock.

Touch and hold the  **3 sec** button to **activate/deactivate** the childproof lock.



To activate the childproof lock:

After the programme starts, Touch and hold the  **3 sec** button for 3 seconds.

-  **3 sec** lights up: The childproof lock is activated.
-  **3 sec** flashes: If a button is touched while childproof lock is activated, the  **3 sec** button will flash.

Note: When the programme ends, **End** is displayed. The door is locked.  **3 sec** and  remain on to remind you to deactivate the childproof lock.

To deactivate the childproof lock:



Touch and hold the  **3 sec** button until the  **3 sec** indicator lamp is off.

Adding/removing laundry

After starting the programme, you can add or remove laundry if necessary.

Touch the  button. The appliance checks whether reloading is possible.

If the following appears on the Touch-Display:

- The symbol  disappears, reloading is possible.
- The symbol  lights up, reloading is not possible.



To continue the programme, touch the  button. The programme continues automatically.

Notes

- Do not leave the door open for too long when adding laundry as water from the laundry may leak out.
- For safety reasons, the door remains locked when the water level or temperature is high, or while the drum is turning, and it is not possible to add laundry during this time.

Changing the programme

If you have started the wrong programme by mistake, you can change the programme as follows:

1. Touch the  button.
2. Select another programme.
3. And touch the  button again. The new programme starts from the beginning.



Note: If drying is activated, you have to switch the appliance off and on again to change the drying programme.

Cancel the programme

For programmes washing at high temperatures:

1. Touch the  button.
2. To cool down laundry: Select **Rinse**.
3. Touch the  button.



For programmes washing at low temperatures:

1. Touch the  button.
2. Select **Spin**.
3. Touch the  button.

For programmes in drying process:

1. Switch the appliance off.
2. Switch the appliance on again.
3. To cool down laundry: Select the **myTime + Dry**.
4. Touch the  button.

Programme end

End lights up on the Touch-Display and  and  displays are off.

If you have selected , the water is only drained after rinse process, no spin cycle.

Notes

- If **Hot** flashes in the display before the drying programme ends, the temperature in the drum is high. The programme for cooling the drum runs until the temperature in the drum has dropped.
- Wrinkle guard process starts after drying process is finished to prevent laundry getting wrinkle if you do not take laundry out in time. The process lasts about 30 minutes. **0:00** will be displayed in time display and  symbol will be displayed as the status symbol. You can touch any area of Touch-Display to terminate this process, then the door will be released and laundry can be taken out.

Removing laundry/switching off the appliance

1. Press the **Ⓛ** button till the indicator lamp turns off, release the button. The appliance is switched off.
2. Open the door and remove the laundry.
3. Turn off the water tap.
Note: Not required for Aqua-Stop models.

Notes

- Do not leave any items of laundry in the drum. They may shrink in the next wash or discolour another item.
- Remove any foreign objects from the drum and the rubber seal – risk of rusting.
- Wipe the rubber seal dry.

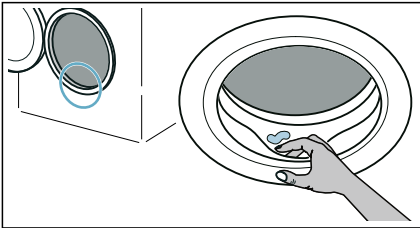

- Leave the door and detergent drawer open so that any residual water can evaporate.
- Always wait until the programme ends, as the appliance could still be locked. Then switch the appliance on and wait for it to unlock.

Appliance settings

Automatic switch-off

If the appliance is not operated for a prolonged period (at least 20 minutes, depending on the water level inside of appliance), it will automatically switch

off before the programme starts or after the programme has ended. Press the power button **Ⓛ** again to switch on the appliance.

Basic settings

To access the basic settings, touch and hold the **🔊 (Silent)** button for approx. 3 seconds. The control panel show:

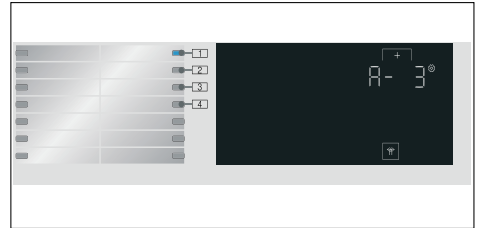

You can change the following basic settings:

- The volume of the end signal.
- The volume of the buttons.
- The brightness of the Touch-Display.
- Switching the Drum clean information signal on/off.

End signal

You can select position **1** and use the **+** button to adjust the volume of the end signal, e.g. **A-3**.

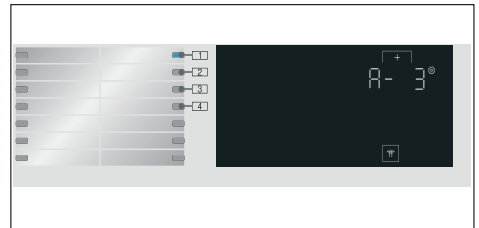

Possible setting values:

- 0 off
- 1 quiet
- 2 medium
- 3 loud
- 4 very loud

Button signal

You can select position **2** and use the **+** button to adjust the volume of the button signal, e.g. **b- 3**.

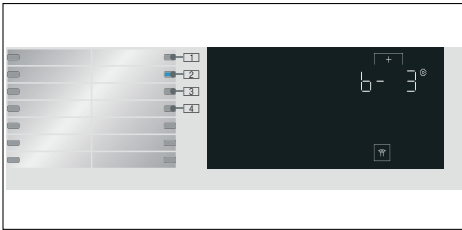

Possible setting values:

- 0 off
- 1 quiet
- 2 medium
- 3 loud
- 4 very loud

Brightness

Possible setting values: 1 - 4

You can select position **3** and use the **+** button to adjust the brightness of the Touch-Display, e.g. **[- 3]**.

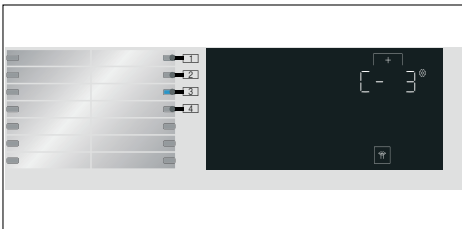

Possible setting values:

- 1 not very bright
- 2 normal level of brightness
- 3 bright
- 4 very bright

Switching the drum-care information signal on/off

You can select position **4** and use the **+** button to switch the **Drum clean** information signal on or off, e.g. **d- 1**.

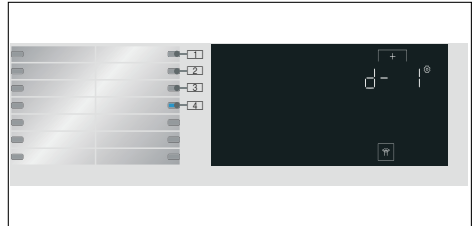

Possible setting values:

- 0 off
- 1 on



Sensors

Unbalanced load detection system

The automatic unbalanced load detection system detects imbalances and ensures even distribution of the laundry by repeatedly starting and stopping drum spinning.

If the laundry is extremely unevenly distributed, the spin speed is reduced or the spin cycle is not performed for safety reasons.

Note: Place large and small items of laundry evenly in the drum.



Cleaning and maintenance



Warning

Risk of death!

There is a risk of electric shock if touch live components.
Press the button ① and pull out the mains plug.

Caution!

Fire and explosion hazard!

Toxic vapours can be produced by cleaning agents that contain solvents, e.g. cleaning solvent.
Do not use cleaning agents that contain solvents.

Caution!

The appliance may be damaged!

Cleaning agents that contain solvents, e.g. cleaning solvent, can damage surfaces and components in the appliance.
Do not use cleaning agents that contain solvents.

Appliance housing/control panel

- Remove the detergent residue immediately.
- Wipe the housing and the control panel with a soft, damp cloth.
- Do not use abrasive cloths, sponges or detergents (stainless steel cleaner).
- Do not clean the appliance with a water jet.

Drum

Use chlorine-free cleaning agents, do not use steel wool.

If there are odours in the appliance, or to clean the drum, run the **Drum clean 90°C** programme without laundry.

Descaling

Descaling should not be necessary if the detergent is measured out correctly. However, if it is required, follow the manufacturer's instructions for the descaling agent. Suitable descalers can be obtained via our website or from customer services.

Detergent drawer and housing

If the appliance contains detergent or fabric softener residues:

1. Pull out the detergent drawer. Press down the insert and fully remove the drawer.

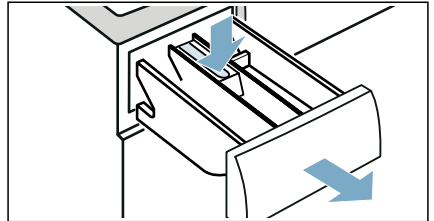

2. To remove the insert: Push the insert upwards from below with your finger.

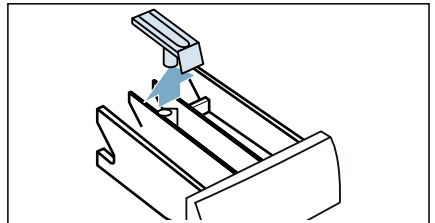

3. Clean the detergent dispenser tray and insert with water and a brush, and dry it. Clean the inside of the housing as well.

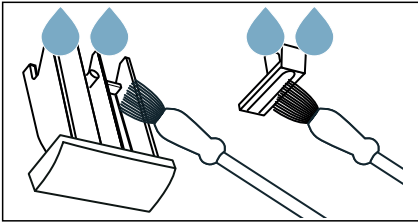

4. Fit the insert and lock it in place (push the cylinder onto the guide pin).

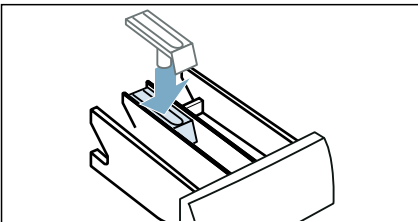

5. Push in the detergent drawer.

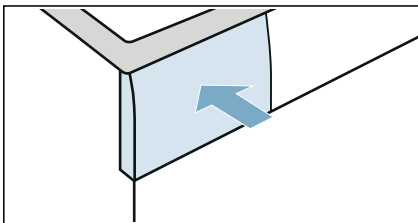

Note: Leave the detergent drawer open so that any residual water can evaporate.

Drain pump is blocked

Note: Turn the water tap off to prevent more water from flowing in and to ensure that it is drained via the pump.

Warning **Risk of scalding!**

When you wash at high temperatures, the water gets very hot. If you come into contact with the hot water, you may be scalded.

Allow the water to cool down first.

1. Switch off the appliance. Pull out the mains plug.
2. Open the service flap.

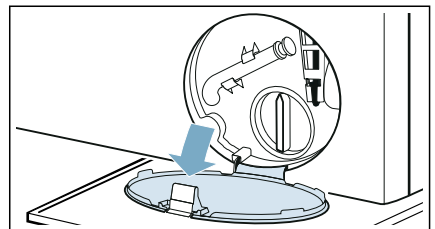

3. Take the drain hose out of the retainer. Remove the sealing cap and pour the water out into a suitable container. Replace the sealing cap and place the drain hose back in the retainer.

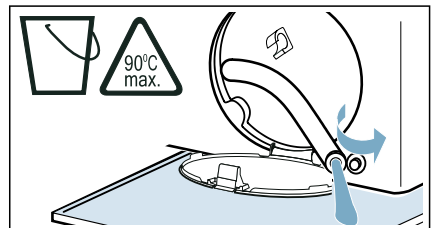

- Carefully unscrew the pump cover; residual water may leak out. Clean the interior, pump cover thread and pump housing. The impeller in the drain pump must be able to rotate.

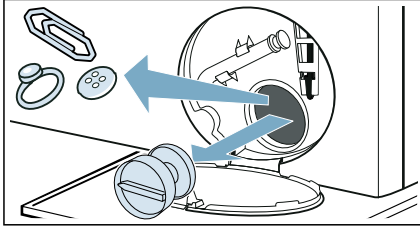

- Refit and screw on the pump cover. The handle must be in a vertical position.

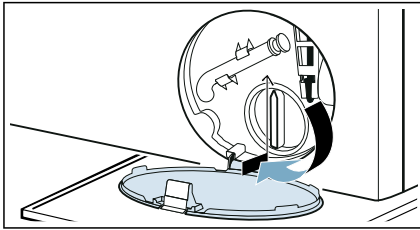

- Close the service flap.

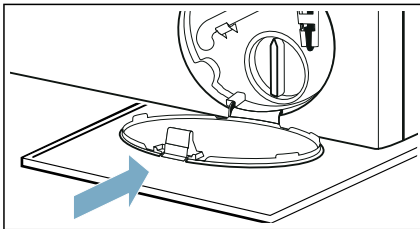

Note: To prevent unused detergent from flowing straight into the drain during the next wash: Pour 1 litre of water into dispenser II and start the **Empty** programme.

The drain hose at the siphon is blocked

- Press the ① button. Pull out the mains plug.
- Loosen the hose clamp. Carefully remove the drain hose; residual water may leak out.
- Clean the drain hose and siphon connecting piece.

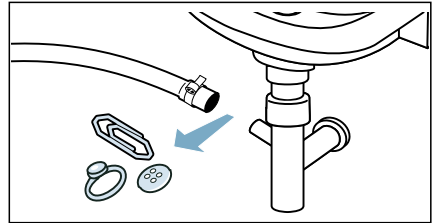

- Re-attach the drain hose and secure the connection point using the hose clamp.

Filter in the water supply is blocked

Release water pressure in the supply hose:

- Turn off the water tap.
- Select the **Cottons** (activate \equiv **Speed** setting) programme.
- Select the \triangleright button. Allow the programme to run for approx. 40 seconds.
- Press the button ①.
- Pull out the mains plug.

Clean the filters:

1. Disconnect the hose from the rear of the appliance.

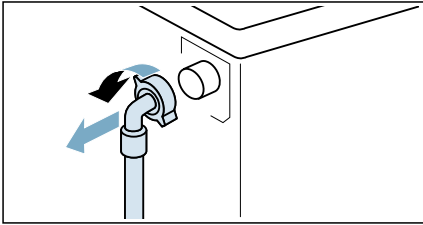

2. Use pliers to remove the filter.

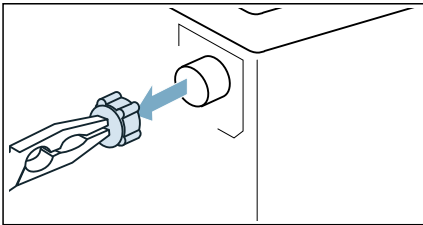

3. Clean the filter with a small brush.

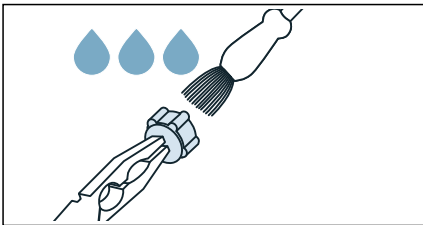

4. Connect the hose and check for leaks.

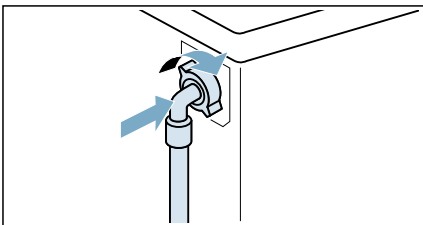

? **Faults and what to do about them**

Emergency release

E.g. power outage or in the event of a loss of power

The programme continues when the power supply is restored.

However, if the laundry has to be removed, the appliance door can be opened as follows:

⚠ Warning

Risk of scalding!

When you are washing at high temperatures, there is a risk of scalding if you come into contact with hot water and laundry.

If possible, leave it to cool down first.

⚠ Warning

Risk of injury!

Reaching into the drum while it is still turning may cause hand injuries.

Do not reach into the drum when it is turning.

Wait until the drum has stopped turning.

Caution!

Water damage!

Any escaping water may cause water damage.

Do not open the door if water can be seen through the glass.

1. Press the ① button. Pull out the mains plug.
2. Open the service flap.

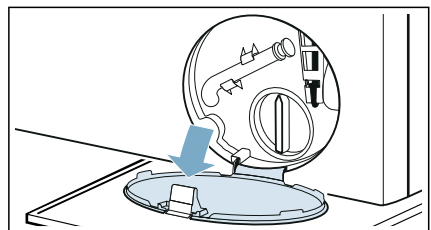



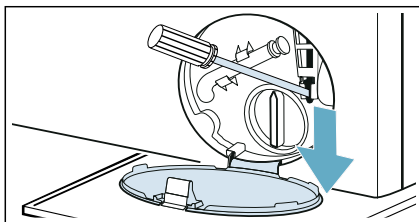

en Faults and what to do about them

3. Drain the water. → *Page 41*
4. Pull the emergency release downwards with a tool and release. The door can then be opened.





Information on the display panel

Display	Cause/Remedy
	<ul style="list-style-type: none"> ■ Flashes fast + signal: The door was opened and the water level is too high. Close the door, continue the programme with ▷ button or select Empty programme. ■ Flashes slowly: The door lock temperature is too high to open the door. Wait approx. 30 seconds until the door lock temperature cools down.
Hot	The temperature in the drum is too high. Wait for the appliance running to cool down the laundry till the Hot disappears on the display panel, then the door can be opened.
	<ul style="list-style-type: none"> ■ Flashes (no water supply): Water tap turned on? Filter in the water supply is blocked? → <i>"Filter in the water supply is blocked" on page 42</i> Is the supply hose kinked or trapped? ■ Lights up (low water pressure): For information only. This will not affect the programme progress. The programme duration is extended.
E:36 alternating with -10	<ul style="list-style-type: none"> ■ Drain pipe or water drain hose is blocked. Clean the drain pipe and the water outlet hose. ■ Drain pipe or water drain hose is caught or jammed. Ensure that the drain pipe and water drain hose are not kinked or trapped. ■ The drain pump is blocked. → <i>"Drain pump is blocked" on page 41</i> ■ The drain hose at the siphon is blocked. → <i>"The drain hose at the siphon is blocked" on page 42</i> ■ The water drain hose is connected too high. Install the water outlet hose at a maximum height of 1 meter. → <i>"Hose and cable lengths" on page 16</i>
H:95 alternating with End when programme is finished	No water detected in drying phase, may get bad drying result.
H:32 alternating with End when programme is finished	The unbalanced load detection system has interrupted the spin cycle because the laundry is unevenly distributed. Distribute small and large items of laundry evenly in the drum.

Display	Cause/Remedy
 3 sec lights up	The childproof lock is activated – deactivate it.
 lights up	Too much foam has been detected and an additional wash cycle has been activated. Add less detergent to the next washing cycle with the same load.
The indicator lamp of the Drum clean programme flashes	Run the Drum clean 90°C programme to clean and care for the drum and the outer tub. Notes <ul style="list-style-type: none"> ■ Run the programme without laundry. ■ Use washing powder or a detergent containing bleach. To prevent foaming, only use half the amount of detergent recommended by the detergent manufacturer. Do not use detergent designed for woollens or delicates. ■ Switching the Drum clean information signal on/off. → "Switching the drum-care information signal on/off" on page 39
Other displays	Switch off the appliance, wait for five seconds and then switch it on again. If the display appears again, call customer service.

Faults and what to do about them

Faults	Cause/Remedy
Water is leaking from the appliance.	<ul style="list-style-type: none"> ■ Attach the drain hose correctly or replace it. ■ Tighten the screw fitting on the supply hose.
The appliance is not filling with water.	<ul style="list-style-type: none"> ■ Programme does not start? ■ Is the water tap turned on?
Detergent is not being dispensed.	<ul style="list-style-type: none"> ■ Could the filter in the water supply be blocked? → "Filter in the water supply is blocked" on page 42 ■ Is the supply hose kinked or trapped?
The wrong detergent/fabric softener has been poured into the dispenser(s).	Dispenser(s): <ol style="list-style-type: none"> 1. Empty and clean. 2. Refill.
Detergent/fabric softener has congealed in the dispensers.	Clean and refill the dispensers.
The door cannot be opened.	<ul style="list-style-type: none"> ■ Childproof lock activated? Deactivate childproof lock. ■ The temperature in drum is too high to open the door. ■ The safety function is activated. Stop the programme? ■ The water level in drum is too high. ■ Can the door only be opened by the emergency release? → "Emergency release" on page 43

Faults	Cause/Remedy
The programme will not start.	<ul style="list-style-type: none"> ■ Have you touched the ▷ button or selected → (Finish in) time? ■ Is the door closed? ■ Childproof lock activated? Deactivate childproof lock. ■ Shop mode activated? If the display shows Shop for 5 s after you have switched on or off the appliance, the appliance is in shop mode. Turn off the shop mode as follows: <ol style="list-style-type: none"> 1. Switch the appliance off and on again. 2. Wait for the display message Shop to disappear. 3. Touch and hold ▷ for at least 5 s. The appliance will automatically switch off. You can use the appliance now as usual.
The programme has started and the drum is rotating, but the drum is not filling with water.	Not a fault – Some programme specifically detect and weigh the load after the program has started in order to calculate the optimum amount of water for washing. The drum will then start filling with water.
The water is not draining.	<ul style="list-style-type: none"> ■ Drain pipe or water drain hose is blocked. Clean the drain pipe and the water drain hose. ■ Drain pipe or water drain hose is caught or jammed. Ensure that the drain pipe and the water drain hose are not kinked or trapped. ■ Could the drain pump be blocked? → "Drain pump is blocked" on page 41 ■ Could the drain hose at the siphon be blocked? → "The drain hose at the siphon is blocked" on page 42 ■ --- (Rinse hold = no final drain) is activated (depending on the module). Continue the programme by selecting Empty and pressing ▷. ■ The water drain hose is connected too high. Install the water drain hose at a maximum height of 1 meter. → "Hose and cable lengths" on page 16
Water is not visible in the drum.	Not a fault – the water is below the visible area.
The spin result is not satisfactory. Laundry wet/too damp.	<ul style="list-style-type: none"> ■ Not a fault – the unbalanced load detection system has interrupted the spin cycle because the laundry is unevenly distributed. Distribute small and large items of laundry evenly in the drum. ■ Is  (Easy iron) additional programme setting selected (depending on the model)? ■ Is  (Silent) additional programme setting or Silent programme selected (depending on the model)? ■ Is the selected spin speed too low?
The spin cycle runs several times.	Not a fault – the unbalanced load detection system is adjusting an imbalance.
Residual water in the dispenser for care product.	<ul style="list-style-type: none"> ■ Not a fault – effect of the care product not impaired. ■ If required, remove the insert. Clean the detergent drawer and re-insert it.
Compartment  is not rinsed out completely.	Remove the insert. Clean the detergent drawer and reinsert it.

Faults	Cause/Remedy
The programme is taking longer than usual.	<ul style="list-style-type: none"> ■ Not a fault – the unbalanced load detection system is adjusting an imbalance by repeatedly distributing the laundry. ■ Not a fault – the foam detection system is activated – a rinse cycle has been switched on.
The length of the programme changes during the wash/dry cycle.	Not a fault – the programme sequence is optimised for the specific washing/drying process. This may change the length of the programme shown on the Touch-Display.
Foam may come out of the detergent drawer.	<p>Too much detergent used?</p> <p>Mix 1 tablespoon of fabric softener with ½ litre of water and pour into dispenser II. (Not for outdoor, sports and down-filled textiles!)</p> <p>Reduce detergent dosage for the next wash cycle.</p> <p>Use commercially available low foam detergent and care product which are suitable for machine.</p>
Odours, stain formation in the appliance.	<p>Run the Drum clean 90°C programme without laundry.</p> <p>Add washing powder or a detergent containing bleach.</p> <p>Note: To prevent foaming, only use half the amount of detergent recommended by the detergent manufacturer. Do not use detergents designed for woollens or delicates.</p>
Loud noises, vibrations and appliance "movement" during the spin cycle.	<ul style="list-style-type: none"> ■ Is the appliance aligned? → <i>"Alignment" on page 18</i> ■ Are the appliance's feet fixed? Secure the appliance's feet. ■ Have the transport locks been removed? → <i>"Removing the transport locks" on page 14</i>
The Touch-Display indicator lights do not work while the appliance is running.	<ul style="list-style-type: none"> ■ Has there been a power failure? ■ Circuit breaker fuses blown? Reset/replace the fuses. ■ If the fault occurs repeatedly, call customer services.
There is detergent residue on the laundry.	<ul style="list-style-type: none"> ■ Some phosphate-free detergents contain water-insoluble residue. ■ Select Rinse or brush the laundry after washing.
Spin noise during the drying phase.	This is an innovative process known as thermal spinning used to reduce energy consumption during the drying phase.
Fluff found on the laundry.	Run the Drum clean * (cold) programme without laundry and detergent to remove fluff which have accumulated inside the drum during the previous drying cycle.
Water inlet noise during the drying phase.	The washer dryer uses water condensation technology, water is constantly needed to dry the laundry. Therefore the water tap must be on all the time, till the end of the drying phase.

Faults	Cause/Remedy
Drying duration extended.	<ul style="list-style-type: none"> ■ Run the Drum clean ✱ (cold) programme to remove fluff which has collected in the washer drum during the drying phase. ■ If the ambient temperature is higher than 30 °C, this may extend the drying time. ■ Insufficient air circulation in the room may increase the drying time. Ventilate the room.
Drying programme does not start.	<ul style="list-style-type: none"> ■ Drying additional programme setting not selected? ■ Door not closed properly?
Creasing.	<ul style="list-style-type: none"> ■ Creasing occurs when you have exceeded the maximum load or selected the wrong program for the type of fabric. All the required information can be found in the programme overview table. ■ Remove clothes immediately after drying; creasing may occur if they are left in the drum.
The drying result is not satisfactory (laundry is not dry enough).	<ul style="list-style-type: none"> ■ After the end of the programme, warm laundry feels damper than it actually is. Spread the laundry out and allow the heat to disperse. ■ Excessively high ambient temperature (above 30 °C) or inadequate ventilation in the room in which the washer dryer is situated. ■ The laundry has not been spun well enough before drying. Always set the highest selectable spin speed for the particular washing programme. ■ Washer dryer overloaded: Observe the recommendations for the maximum load in the programme table and on the load display. Do not overload the washer dryer, as the maximum load for the drying phase is less than the maximum load for the wash cycle. Unload the washer dryer after washing with the maximum load and divide the laundry into two drying cycles. ■ The power supply voltage is too low (below 200 V) – provide a suitable power supply. ■ The water pressure is low. According to water condensing principle, low water pressure will cause evaporated steam to not condense properly and completely. ■ The water tap is closed during drying. Due to the use of the water condensation technology for drying, please keep the connected water tap open during the drying process, otherwise proper drying cannot be guaranteed. ■ Thick multilayered textiles or textiles with thick fillings dry easily on the surface, but not inside. This equalisation process may take longer. For these types of textiles, select drying mode * (Cupboard dry+) or select myTime with Dry.
<p>If you cannot rectify a fault yourself (after switching the appliance off and on again) or a repair is required:</p> <ul style="list-style-type: none"> ■ Switch off the appliance and pull out the mains plug. ■ Turn off the water tap and call customer service. 	



After-sales service

If you cannot rectify a fault yourself, (→ *"Faults and what to do about them" on page 43*), please contact our after-sales service.

We will always find an appropriate solution to avoid unnecessary visits by engineers.

Please provide the after-sales service with the product number (E-Nr.) and the production number (FD) of the appliance.

E-Nr. _____	FD _____
-------------	----------

E-Nr.	Product number
FD	Production number

You can find this information (depending on the model):

- On the inside of the loading door
- On the back of the appliance

Trust the expertise of the manufacturer. Contact us. By doing so, you can be sure that the repairs are carried out by trained service personnel using genuine spare parts.



Consumption values

Energy and water consumption, programme duration and residual moisture for the main washing programme

(approximate values)

Programme	Load	Energy consumption*	Water consumption*	Programme duration*
Cottons 20 °C	10,0 kg	0,39kWh	91 l	3¼ h
Cottons 40 °C	10,0 kg	1,32 kWh	91 l	4 h
Cottons 60 °C	10,0 kg	1,54 kWh	92 l	3¼ h
Cotton 60 °C + Eco **	10,0 kg	1,22 kWh	70 l	5 h
Cotton 60 °C + Eco (washing)	10,0 kg			
Cotton + Dry + Speed + + (Cupboard dry+) (drying) **	6,0 kg	4,81 kWh	70 l	8 h
Cotton 90 °C	10,0 kg	2,70 kWh	104 l	3¼ h
Easy-Care 40 °C	4,0 kg	0,77 kWh	69 l	2¼ h
Mix 40 °C	4,0 kg	0,63 kWh	50 l	1¼ h
Delicates/Silk 30 °C	2,0 kg	0,21 kWh	35 l	¾ h
Wool 30 °C	2,0 kg	0,21 kWh	41 l	¾ h
Cotton + Dry + Speed + (Cupboard dry) (drying)	6,0 kg	3,11 kWh	38 l	2¼ h
Easy-Care + Dry + Speed + (Cupboard dry) (drying)	2,5 kg	1,32 kWh	21 l	1½ h

Values determined according to the valid version of IEC62512.

* Observed values may deviate from the indicated values due to influence of water pressure, hardness and inlet temperature, ambient temperature, type, amount and soiling of laundry, detergent used, fluctuations in power supply and selected additional functions.

** Program setting with maximum spin speed for testing and energy labeling according to valid version of UAE.S 5010-2 with cold water (25°C).



Technical data

Dimensions:

848 mm x 598 mm x 620 mm
(height x width x depth)

Weight:

84 kg

Mains connection:

Nominal voltage 220-240V, 50 Hz

Minimum installation protection (\equiv)10 A

Nominal power 1900-2300 W

Water pressure:

100–1000 kPa (1–10 bar)



Aqua-Stop warranty

Only for appliances with Aqua-Stop

In addition to warranty claims against the vendor based on the purchase agreement and to our appliance warranty, we will provide compensation under the following conditions:

1. If water damage is caused due to a fault in our Aqua-Stop system, we will compensate domestic customers for the damage caused.
2. The liability guarantee is valid for the service life of the appliance.
3. It is a prerequisite of all warranty claims that the appliance with Aqua-Stop must have been installed and connected correctly in accordance with our instructions; this also includes a correctly fitted Aqua-Stop extension (genuine accessories). Our warranty does not cover defective feed lines or fittings leading to the Aqua-Stop connection at the tap.
4. Appliances with Aqua-Stop do not need to be supervised during operation, nor secured afterwards by turning off the tap.
The tap only needs to be turned off if you are away from home for a long period, e.g. for several weeks' holiday.

BSH Hausgeräte GmbH
Carl-Wery-Straße 34
81739 München, GERMANY
siemens-home.bsh-group.com

Manufactured by BSH Hausgeräte GmbH under the trademark licence of Siemens AG



9001381863 (020525)

en