

SIEMENS



Steam oven

















CD634GB.1B

siemens-home.bsh-group.com/welcome

en Instruction manual

Register
your
product
online

Table of contents

	Intended use	4		Basic settings	17
	Important safety information	4	Changing settings		
	Causes of damage	5	List of settings		
	Environmental protection	6	Changing the time		
	Tips for saving energy	6		Cleaning	18
	Environmentally-friendly disposal	6	cleaning agents		
	Getting to know your appliance	7	Descal		
	Control panel	7	Removing and fitting the appliance door		
	Controls	7	Removing and installing the door panels		
	Display	7	Cleaning the rails		
	Steaming menu	8		Trouble shooting	22
	Operating modes menu	8	Fault table		
	Further information	8	Replacing the cooking compartment bulb		
	Cooking compartment functions	8	Replacing the glass cover or seals		
	Accessories	9	Changing the door seal		
	Accessories included	9		Customer service	24
	Inserting accessories	9	E number and FD number		
	Optional accessories	9		Settings table and tips	24
	Before using for the first time	10	Accessories		
	Before using for the first time	10	Ovenware		
	Initial use	10	Cooking time and quantity		
	Calibrating the appliance and cleaning the cooking compartment	10	Distributing food evenly		
	Cleaning the accessories	11	Pressure-sensitive food		
	Operating the appliance	11	Cooking a menu		
	Switching the appliance on and off	11	Vegetables		
	Starting or interrupting operation	12	Side dishes and pulses		
	Filling the water tank	12	Poultry and meat		
	Setting the type of heating and temperature	12	Fish		
	After each use	13	Soup vegetables, miscellaneous		
	Time-setting options	13	Dessert, compote		
	Timer	13	Reheating food		
	Cooking time	14	Defrosting		
	End time	14	Prove dough		
	Dishes	15	Extracting juice		
	Selecting and setting food	15	Preserving		
	Instructions for the dishes	15	Frozen products		
	Table	16	Test dishes		
	Childproof lock	17			
	Activating and deactivating	17			

Additional information on products, accessories, replacement parts and services can be found at www.siemens-home.bsh-group.com and in the online shop www.siemens-home.bsh-group.com/eshops

Intended use

Read these instructions carefully. Only then will you be able to operate your appliance safely and correctly. Retain the instruction manual and installation instructions for future use or for subsequent owners.

This appliance is only intended to be fully fitted in a kitchen. Observe the special installation instructions.

Check the appliance for damage after unpacking it. Do not connect the appliance if it has been damaged in transport.

Only a licensed professional may connect appliances without plugs. Damage caused by incorrect connection is not covered under warranty.

This appliance is intended for domestic use only. The appliance must only be used for the preparation of food and drink. The appliance must be supervised during operation. Only use this appliance indoors.

This appliance is intended for use up to a maximum height of 2000 metres above sea level.

This appliance may be used by children over the age of 8 years old and by persons with reduced physical, sensory or mental capabilities or by persons with a lack of experience or knowledge if they are supervised or are instructed by a person responsible for their safety how to use the appliance safely and have understood the associated hazards.

Children must not play with, on, or around the appliance. Children must not clean the appliance or carry out general maintenance unless they are at least 15 years old and are being supervised.

Keep children below the age of 8 years old at a safe distance from the appliance and power cable.

Always slide accessories into the cooking compartment the right way round.

→ "Accessories" on page 9

Important safety information

Warning – Risk of burns!

- The appliance becomes very hot. Never touch the interior surfaces of the cooking compartment or the heating elements. Always allow the appliance to cool down. Keep children at a safe distance.
- Accessories and ovenware become very hot. Always use oven gloves to remove accessories or ovenware from the cooking compartment.
- Hot steam may escape during operation. Do not touch the ventilation openings. Keep children away.

Warning – Risk of scalding!

- The accessible parts become hot during operation. Never touch the hot parts. Keep children at a safe distance.
- Water in a hot cooking compartment may create hot steam. Never pour water into the hot cooking compartment.
- When you open the appliance door, hot steam can escape. Steam may not be visible, depending on its temperature. When opening, do not stand too close to the appliance. Open the appliance door carefully. Keep children away.
- The water in the evaporator dish is still hot even after the appliance has been switched off. Do not empty the evaporator dish immediately after switching off the appliance. Allow the appliance to cool down before cleaning it.
- Hot liquid may spill over the sides of the accessory when it is removed from the cooking compartment. Remove hot accessories with care and always wear oven gloves.

Warning – Risk of injury!

- Scratched glass in the appliance door may develop into a crack. Do not use a glass scraper, sharp or abrasive cleaning aids or detergents.
- Flammable liquids can catch fire in the cooking compartment when it is hot (explosion). Do not fill the water tank with any flammable fluids (e.g. alcoholic drinks). Only fill the water tank with water or with the descaling solution that is recommended by us.

⚠ Warning – Risk of electric shock!

- Incorrect repairs are dangerous. Repairs may only be carried out by one of our trained after-sales engineers. If the appliance is faulty, unplug the mains plug or switch off the fuse in the fuse box. Contact the after-sales service.
- The cable insulation on electrical appliances may melt when touching hot parts of the appliance. Never bring electrical appliance cables into contact with hot parts of the appliance.
- Do not use any high-pressure cleaners or steam cleaners, which can result in an electric shock.
- When replacing the cooking compartment bulb, the bulb socket contacts are live. Before replacing the bulb, unplug the appliance from the mains or switch off the circuit breaker in the fuse box.
- A defective appliance may cause electric shock. Never switch on a defective appliance. Unplug the appliance from the mains or switch off the circuit breaker in the fuse box. Contact the after-sales service.

 Causes of damage**Caution!**

- Accessories, foil, greaseproof paper or ovenware on the cooking compartment floor: Do not place accessories on the cooking compartment floor. Do not cover the cooking compartment floor with any sort of foil or greaseproof paper. The cooking compartment floor and the evaporator dish must always be kept clear. A build-up of heat may damage the appliance. Always place ovenware in a perforated cooking container or on a wire rack.
- Aluminium foil in the cooking compartment must not come into contact with the door panel. This could cause permanent discolouration of the door panel.
- Ovenware: Ovenware must be heat and steam resistant.
- Ovenware with areas of rust: Do not use any ovenware which displays areas of rust. Even the smallest spots of rust can lead to corrosion in the cooking compartment.
- Dripping liquids: When steaming with a perforated cooking container, always insert the baking tray, the universal pan or the solid cooking container underneath. Dripping liquid is caught.
- Moisture in the cooking compartment: Over an extended period of time, moisture in the cooking compartment may lead to corrosion. Allow the cooking compartment to dry after use. Do not keep moist food in the closed cooking compartment for extended periods of time. Do not store food in the cooking compartment.
- Extremely dirty seal: If the seal is very dirty, the appliance door will no longer close properly during operation. The fronts of adjacent units could be damaged. Always keep the seal clean.
→ "Cleaning" on page 18
- Appliance door as a seat, shelf or worktop: Do not sit on the appliance door, or place or hang anything on it. Do not place any cookware or accessories on the appliance door.
- Inserting accessories: depending on the appliance model, accessories can scratch the door panel when closing the appliance door. Always insert the accessories into the cooking compartment as far as they will go.
- Carrying the appliance: do not carry or hold the appliance by the door handle. The door handle cannot support the weight of the appliance and could break.
- Looking after the appliance: The cooking compartment on your appliance is made of high-quality stainless steel. Improper care may lead to corrosion in the cooking compartment. Refer to the care and cleaning instructions in the instruction manual. Remove food residues from the cooking compartment as soon as the appliance has cooled.
- Hot water in the water tank: Hot water can damage the pump. Only fill the water tank with cold water.
- Descaling solution: Do not allow any descaling solution to come into contact with the control panel or other surfaces on the appliance. This damages the surfaces. If this does happen, remove the descaling solution immediately with water.
- Cleaning the water tank: Do not clean the water tank in the dishwasher. Otherwise, the water tank will be damaged. Clean the water tank with a soft cloth and standard washing-up liquid.

Environmental protection

Your new appliance is particularly energy-efficient. Here you can find tips on how to save even more energy when using the appliance, and how to dispose of your appliance properly.

Tips for saving energy

- Only preheat the appliance if this is specified in the recipe or in the operating instructions table.
- Open the appliance door as infrequently as possible while the food is cooking.
- When steaming, you can cook on several levels at the same time. When preparing foods with different cooking times, those with the longest cooking time should be placed in the oven first.

Environmentally-friendly disposal

Dispose of packaging in an environmentally-friendly manner.



This appliance is labelled in accordance with European Directive 2012/19/EU concerning used electrical and electronic appliances (waste electrical and electronic equipment - WEEE). The guideline determines the framework for the return and recycling of used appliances as applicable throughout the EU.

Getting to know your appliance

In this chapter, we will explain the indicators and controls. You will also find out about the various functions of your appliance.

Note: Depending on the appliance model, individual details and colours may differ.

Control panel

In the control panel, you can use the buttons and rotary selector to set the various functions of the appliance. The current settings are shown on the display.



- 1 Buttons**
The buttons to the left and right of the rotary selector have a pressure point. Press these buttons to activate them.
- 2 Rotary selector**
You can turn the rotary selector clockwise and anti-clockwise.
- 3 Display**
You can see the current adjustment values, options or notes in the display.
- 4 Touch fields**
There are sensors under the touch fields to the left < and right > of the display. Touch the respective arrow to select the function.

Touch fields

<	Field to the left of the display	Navigates left
>	Field to the right of the display	Navigates right

Rotary selector

Use the rotary selector to change the operating modes and adjustment values shown in the display.

In most selection lists, e.g. types of heating, the first selection follows the last. For temperature for example, you must turn the rotary selector back when the minimum or maximum temperature is reached.

Controls

Use the controls to set your appliance simply and directly.

Buttons and touch fields

Here you can find a short explanation of the various buttons and touch fields.

Buttons		Meaning
on/off		Switches the appliance on and off
menu	Menu	Opens the operating modes menu
i	Information	Displays notes
⌚	Time-setting options	Opens the time-setting options menu
🔒	Childproof lock	Activates/deactivates the child-proof lock
Start/Stop		Starts, pauses or cancels operation

Display

The display is structured so that the information can be read at a glance.

The value that you can currently set is in focus. It is displayed in white lettering with a dark background.

Status bar

The status bar is at the top of the display. The time and set time functions are displayed here.

Temperature indicator





The temperature indicator bars show the heating phases in the cooking compartment.

Heating indicator	The heating indicator displays the rising temperature in the cooking compartment. When all bars are filled, the optimum time for placing the dish in the oven has been reached.
Residual heat indicator	When the appliance is switched off, a line appears under the status bar which shows how much residual heat is in the cooking compartment. Once the temperature has dropped to approximately 60 °C, the display goes out.

Note: Due to thermal inertia, the temperature displayed may be slightly different to the actual temperature inside the oven. You can use the  button to check the current heating temperature when heating up.

Steaming menu

Your appliance has different types of heating. After switching on the appliance, you are taken directly to the Steaming menu, in which you can find the types of heating.

Steam heating type	Temperature	Use
 Steaming	30-100 °C	For vegetables, fish, side dishes, for juicing fruit and for blanching
 Reheating	80-100 °C	For plated meals Cooked food is gently reheated. The steam ensures that the food does not dry out
 Prove dough	30-50 °C	For yeast dough Dough will rise considerably more quickly than at room temperature. The surface of the dough does not dry out
 Defrosting	30-60 °C	For fruit and vegetables The moisture gently transfers the heat to the food. The food does not dry out or lose its shape

Default values

The appliance suggests a temperature or setting for each heating type. You can accept this value or change it in the appropriate area.

Opening the appliance door

If you open the appliance door during an operation, the operation is paused. Operation continues to run when you close the door.

Operating modes menu

The menu is divided into different operating modes. In this way, you can quickly access the required function.

Interior lighting

When you open the appliance door, the interior lighting switches on. If the door remains open for longer than 15 minutes, the lighting switches off again.

Operating mode	Use
Steaming → "Operating the appliance" on page 11	Setting and starting the appropriate type of steam heating.
Dishes	Prepare dishes with steam.
Descal	Descals the water supply system.
Settings → "Basic settings" on page 17	You can adapt your appliance's basic settings to suit your needs.

For most operating modes, the interior lighting switches on as soon as the operation is started. When the operation has finished, the lighting switches off.

Note: You can set the interior lighting not to come on during the operation in the basic settings.

Further information

In most cases, the appliance provides notes and further information on the action just carried out. To do this, press the  button. The note is shown for a few seconds.

Cooling fan

The cooling fan switches on and off as required. The hot air escapes above the door.

Some notes are displayed automatically, for example as confirmation, or to provide an instruction or warning.

Caution!

Do not cover the ventilation slots. Otherwise the oven will overheat.

So that the cooking compartment cools down more quickly after operation, the cooling fan continues to run for a certain period afterwards.

Note: You can change how long the cooling fan continues to run for in the basic settings. → "Basic settings" on page 17

Cooking compartment functions

Some functions make your appliance easier to use. This, for example, enables the cooking compartment to be well lit and a cooling fan to prevent the appliance from overheating.

Accessories

Your appliance is accompanied by a range of accessories. Here, you can find an overview of the accessories included and information on how to use them correctly.

Accessories included

Your appliance is equipped with the following accessories:

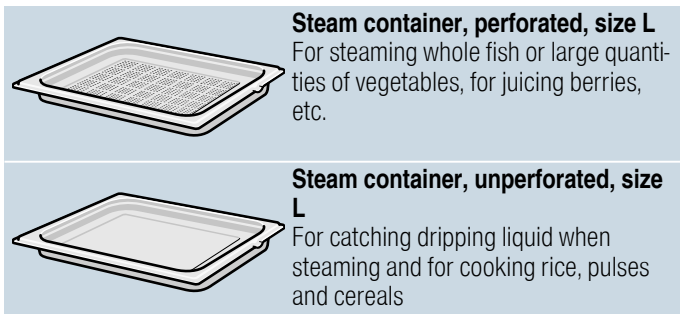

Only use genuine accessories. They are specially adapted for your appliance.

You can buy accessories from the after-sales service, from specialist retailers or online.

Inserting accessories

The cooking compartment has four shelf positions. The shelf positions are counted from the bottom up.

In some appliances, the top shelf position in the cooking compartment features a grill symbol.

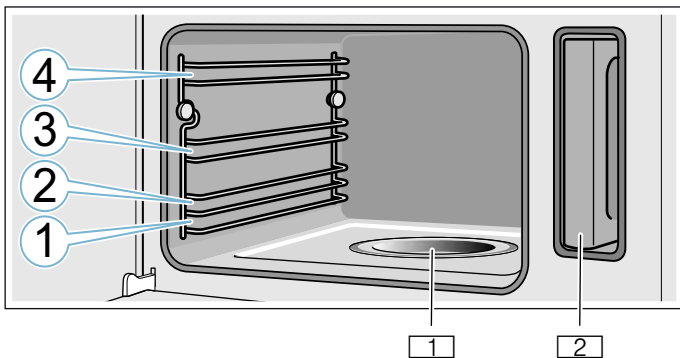

- 1 Evaporator dish
- 2 Water tank in the water tank recess

Caution!

- Do not place anything on the cooking compartment floor. Do not cover it with aluminium foil. A build-up of heat could damage the appliance. The cooking compartment floor and the evaporator dish must always be kept clear. Always place ovenware in a perforated cooking container or on a wire rack.
- Do not slide any accessories between the shelf positions, or they may tip.

Locking function

The accessories can be pulled out approximately halfway before they lock in place. The locking function prevents the accessories from tilting when they are pulled out.

- The accessories must be inserted into the cooking compartment the right way round for the tilt protection to work properly.
- Always insert the accessories fully into the cooking compartment so that they do not touch the appliance door.

When inserting the wire rack, ensure that the lug **b** is facing downwards and the **a** safety lug on the wire rack is at the rear and is facing upwards.

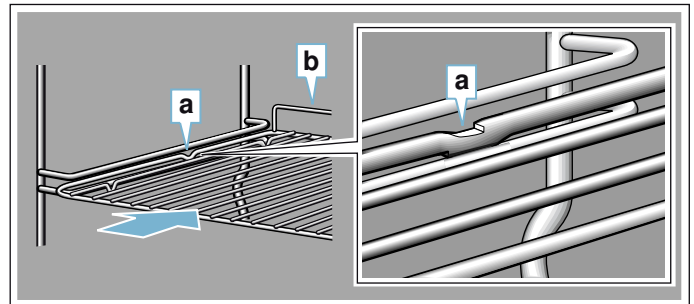

When inserting steam containers, make sure that the lug **c** is at the back and is facing downwards.

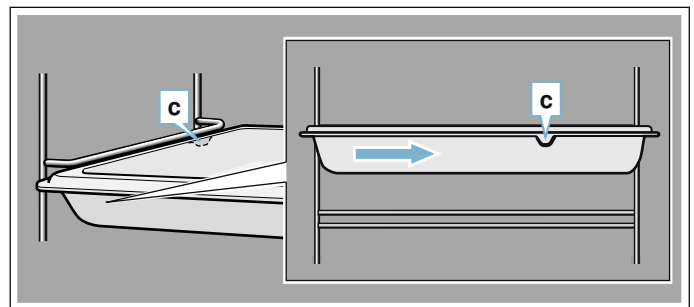

Optional accessories

You can buy optional accessories from the after-sales service, from specialist retailers or online. *You will find a comprehensive range of products for your appliance in our brochures and online.

Both availability and whether it is possible to order online differ between countries. Please see your sales brochures for more details.

Note: Not all optional accessories are suitable for every appliance. When purchasing, please always quote the exact identification number (E-no.) of your appliance.
→ "Customer service" on page 24

Special accessories

- Steam container, perforated, size S
- Steam container, solid, size S
- Steam container, perforated, size L
- Steam container, solid, size L
- Wire rack for steamer
- Porcelain cooking container, solid, size S
- Porcelain cooking container, solid, size L

Decorative trims

For concealing the lower shelf of the unit and the base of the appliance.



Before using for the first time

Before you can use your new appliance, you must make some settings. You must also clean the cooking compartment and accessories.

Before using for the first time

Before using the appliance for the first time, enquire about the water hardness of your tap water from your water supplier.

So that the appliance can reliably remind you to decalcify it when required, you must correctly set your water hardness range.

Caution!

The appliance may become damaged due to the use of unsuitable liquids.

Do not use distilled water, highly chlorinated tap water (>40 mg/l) or other liquids.

Only use cold, fresh tap water, softened water or non-carbonated mineral water.

Notes

- If your water is very hard, we recommend that you use softened water.
- If you only use softened water, you can set the water hardness range to "softened" in this case.
- If you use mineral water, set the water hardness range to "4 very hard".
- If you use mineral water, you must only use non-carbonated mineral water.

Water hardness range	Setting
0	0 softened
1 (up to 1.3 mmol/l)	1 soft
2 (1.3 - 2.5 mmol/l)	2 medium
3 (2.5 - 3.8 mmol/l)	3 hard
4 (above 3.8 mmol/l)	4 very hard

Initial use

Notes

- You can change these settings at any time in the basic settings. → *"Basic settings" on page 17*
- After connecting the appliance to the power or following a power cut, the settings for initial use are shown in the display.

Setting the language

1. Use the rotary selector to select the required language.
2. Touch the > arrow.
The next setting appears.

Setting the time

1. Use the rotary selector to set the current time.
2. Touch the > arrow.

Setting the date

1. Use the rotary selector to set the current day, month and year.
2. Touch the > field.
The next setting appears.

Setting the water hardness

1. Turn the rotary selector to the right until your water hardness range appears.
2. Touch the arrow > to confirm.
A note appears in the display confirming that the initial use has been completed.

Calibrating the appliance and cleaning the cooking compartment

Before using the appliance to prepare food for the first time, you must calibrate the appliance and clean the cooking compartment.

Calibrating the appliance and cleaning the cooking compartment

The boiling point of water depends on the air pressure. During calibration, the appliance sets itself to the pressure ratio at the installation location. This occurs automatically during the first steam operation. This results in a lot of steam.

Preparing the calibration

1. Remove the accessories from the cooking compartment.
2. Remove leftover packaging, such as polystyrene pellets, from the cooking compartment.
3. Before calibrating the appliance, wipe the smooth surfaces in the cooking compartment with a soft, damp cloth.

Calibrating the appliance and cleaning the cooking compartment

Notes

- The calibration can only be started once the cooking compartment is cold (room temperature).
 - Do not open the appliance door during calibration. Calibration will otherwise be interrupted.
1. Press the On/Off button to switch on the appliance.
 2. Fill the water tank. → *"Filling the water tank" on page 12*
 3. Set the specified heating type, temperature and cooking time, then start the appliance operation.

Settings	
Heating type	Steam
Temperature	100 °C
Cooking time	20 minutes

4. Press the On/Off button to switch off the appliance.
5. Wait until the cooking compartment has cooled down.
6. Clean the smooth surfaces with soapy water and a dish cloth.
7. Empty the water tank and dry the cooking compartment. → *"After each use" on page 13*

Notes

- So that the appliance adapts to a new installation location after moving house, reset the appliance to the factory settings. Repeat the initial use settings and the calibration.
- The appliance saves the calibration settings, even in the event of a power cut or disconnection from the mains. Recalibration is not necessary.

Cleaning the accessories

Clean the accessories thoroughly using soapy water and a dish cloth or soft brush.



Operating the appliance

You have already learnt about the controls and how they work. Now we will explain how to set your appliance. You will learn about what happens when you switch the appliance on and off, and how to select the operating mode.

Warning – Risk of scalding!

When you open the appliance door, hot steam can escape. Steam may not be visible, depending on its temperature. When opening, do not stand too close to the appliance. Open the appliance door carefully. Keep children away.

Warning – Risk of scalding!

The water in the evaporator dish is still hot even after the appliance has been switched off. Do not empty the evaporator dish immediately after switching off the appliance. Allow the appliance to cool down before cleaning it.

Warning – Risk of scalding!

When you open the appliance door, hot water may flow out of the appliance. When opening the door, do not stand too close to the appliance. Open the appliance door carefully. Keep children away from the appliance. If the evaporator dish overflows, do not pour more water into the water tank.

Switching the appliance on and off

Before you are able to set the appliance, you must switch it on.

Exception: The childproof lock and the timer can be set when the appliance is switched off.

Displays or information, e.g the residual heat indicator in the cooking compartment, remain visible in the display after the appliance has been switched off.

Switch off your appliance when you do not need to use it. If no settings are applied for a long time, the appliance switches itself off automatically.

Switching the appliance on

Use the On/Off button to switch the appliance on. The on/off symbol above the button is illuminated in blue.

The Siemens logo appears in the display, and then a type of heating and a temperature.

Note: You can specify which operating modes should appear after the appliance is switched on in the basic settings.

Switching off the appliance

Use the On/Off button to switch off the appliance. The lighting above the button goes out.

A set function is cancelled.

The time appears in the display.

Note: You can set whether or not the time should be displayed when the appliance is switched off in the basic settings.

Starting or interrupting operation

To start operation or to interrupt an operation which has started running, press the Start/Stop button. The cooling fan may continue to run after an operation is interrupted.

Press the On/Off button to delete all settings.

If you open the cooking compartment door during operation, operation is interrupted. Close the cooking compartment door to continue operation.

Filling the water tank

When you open the appliance door, you will see the water tank on the right-hand side. Before starting the operation, fill the water tank with water.

Ensure that you have correctly set the water hardness range. → "Basic settings" on page 17

Caution!

The appliance may become damaged due to the use of unsuitable liquids.

Do not use distilled water, highly chlorinated tap water (> 40 mg/l) or other liquids.

Only use cold, fresh tap water, softened water or uncarbonated mineral water.

Fill the water tank before each use:

1. Open the appliance door.
2. Remove the water tank from the water tank recess (picture 1).
3. Fill the water tank with cold water up to the "max." mark. (Picture 2).

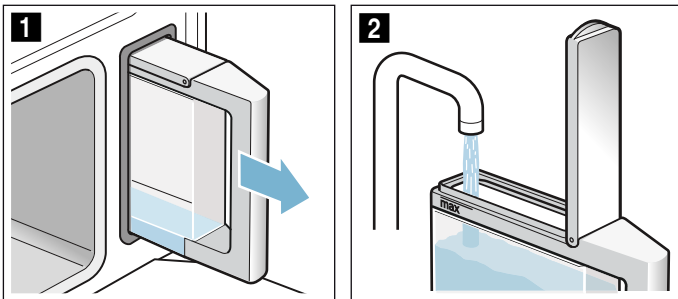

4. Close the tank cover until you feel it engage.
5. Insert the filled water tank (picture 3).
6. Check whether the water tank is pushed in flush with the water tank recess (picture 4).

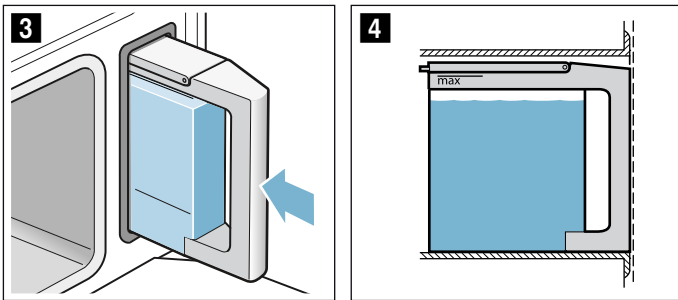

7. Close the appliance door.

The water tank has been filled. You can now start the operation.

Refilling the water tank

If the water tank is empty, the prompt to fill the water tank appears on the display. The operation is stopped.

⚠ Warning – Risk of scalding!

When you open the appliance door, hot water may flow out of the appliance. When opening the door, do not stand too close to the appliance. Open the appliance door carefully. Keep children away from the appliance. If the evaporator dish overflows, do not pour more water into the water tank.

1. Carefully open the appliance door.
2. Remove the water tank and fill it.
3. Slide the water tank back in and close the appliance door.
4. Start the operation.
The operation continues.

Setting the type of heating and temperature

After the appliance is switched on, the suggested type of heating appears with the temperature. You can start this setting immediately with the Start/Stop button.

For other settings, you can change the values as shown in the pictures.

Example: 15 minutes steaming at 90 °C

1. Use the rotary selector to change the type of heating.

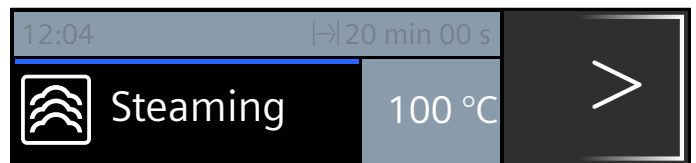

2. Press the arrow > to switch to the temperature.
3. Use the rotary selector to change the temperature.

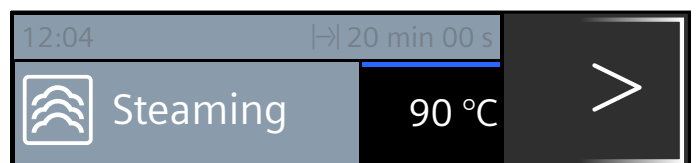

4. Use the ⊖ button to switch to the cooking time.
5. Use the rotary selector to change the cooking time.

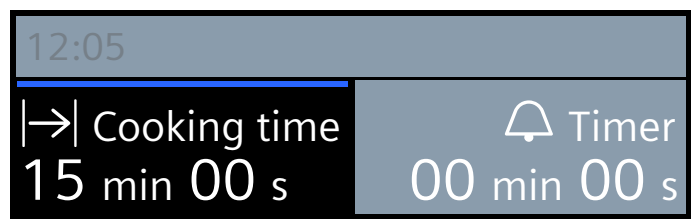

6. Press the Start/Stop button.

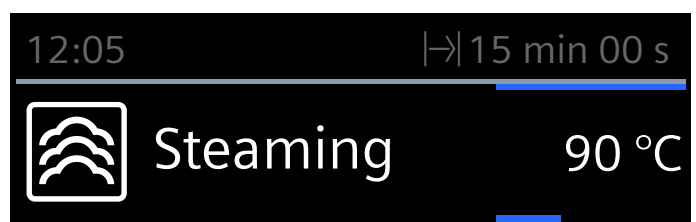

The set type of heating, temperature and cooking time are shown in the display.

“Fill water tank?” message

This message appears if you set a type of heating and the water tank is only half full.

If you think that the water in the water tank is sufficient for the cooking procedure, you can start the appliance.

If not, fill the water tank to the "max" mark, slide it back in and start the appliance.

After each use

Warning – Risk of scalding!

When you open the appliance door, hot steam can escape. Steam may not be visible, depending on its temperature. When opening, do not stand too close to the appliance. Open the appliance door carefully. Keep children away.

Moisture and dirt remain in the cooking compartment after each operation. Therefore dry and clean the appliance after each use. Also empty the water tank after each use.

Drying the cooking compartment

Warning – Risk of scalding!

The water in the evaporator dish may still be hot. Allow it to cool before wiping.

1. Leave the appliance door ajar until the appliance has cooled down.
2. Remove any dirt from the cooking compartment immediately.
3. Wipe out the cooled cooking compartment and evaporator dish with the cleaning sponge and dry with a soft cloth.
4. Wipe the front of the units dry if condensation has formed.

Emptying the water tank

The water tank must be emptied and dried after each steam operation.



Caution!

- Do not dry the water tank in the hot cooking compartment. This will damage the water tank.
- Do not clean the water tank in the dishwasher. This will damage the water tank.

1. Open the appliance door.
2. Remove the water tank and empty the residual water.
3. Thoroughly dry the seal in the tank cover and the water tank recess in the appliance.
4. Insert the water tank into the water tank recess.
5. Close the appliance door.

Time-setting options

Your appliance has different time-setting options.

Time-setting option	Use
 Timer	The timer functions like an egg timer. An audible signal sounds once the set time has elapsed.
 Cooking time	A signal sounds once a set cooking time has elapsed. The appliance switches off automatically.
 End	Set a cooking time and an end time. The appliance switches off automatically so that the operation ends at the desired time.

Notes

- A cooking time of up to one hour can be set exactly to the minute.
A cooking time over one hour can be set in five-minute increments.
- The maximum setting you can make is 23 hours and 59 minutes.
- After a time-setting option has elapsed, a signal sounds.
- Using the  button, you can request information during operation, which then appears briefly in the display.

Timer

You can set the timer at any time, even if the appliance is switched off. It runs parallel to the other time settings and has a separate audible signal. In this way, you can tell whether it is the timer or a cooking time which has elapsed.

The maximum setting you can apply is 24 hours.



1. Press the  button.
The field for the timer opens.
2. Use the rotary selector to set the timer duration.
The timer starts after a few seconds.

The  symbol for the timer and the time counting down are displayed on the left in the status bar.



When the time has elapsed

An audible signal sounds. "Timer elapsed" appears in the display. Use the  button to cancel the audible signal early.

Cancelling the timer duration

Press the  button to open the time-setting options menu and turn the time back. Press the  button to close the menu.

Changing the timer duration

Use the  button to open the time-setting options menu and change the timer time in the next few seconds using the rotary selector. Start the timer with the  button.

Cooking time

If you set the cooking time for your meal, operation stops automatically once this time has elapsed. The oven stops heating.

Prerequisite: A heating type and a temperature have been set.

1. Press the  button.
The time-setting options menu opens.

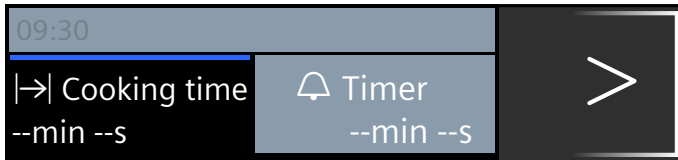

2. Set the cooking time using the rotary selector.





3. Press the Start/Stop button to start.
You can see the  cooking time counting down in the status bar.

The cooking time has elapsed

A signal sounds. The oven stops heating. You can cancel the audible signal early using the  button.

Cancelling the cooking time

Press the  button to open the time-setting options menu and turn the cooking time back. The operation ends. Press the  button to close the menu.

Changing the cooking time



Press the  button to open the time-setting options menu. Change the cooking time using the rotary selector.

End time

If you change the end time, please remember that easily spoiled foods must not be allowed to remain in the cooking compartment for too long.

Prerequisite: The selected operation has not already begun. A cooking time has been set. The time-setting options menu  is open.

Example in the picture: You put the dish in the cooking compartment at 9:30. It takes 45 minutes to cook and will be ready at 10:15, but you would like it to be ready at 12:45 instead.

1. Touch the  arrow to continue to " End".
2. Set the end time using the rotary selector.

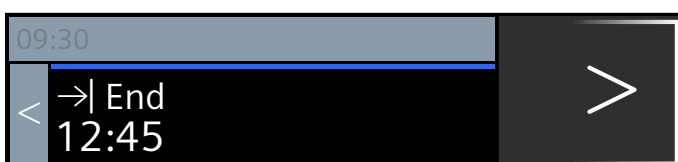

3. Confirm with the Start/Stop button.

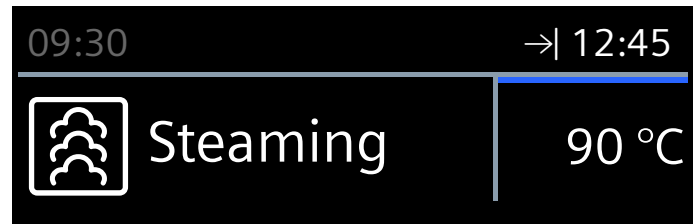

The oven is in standby. The  symbol and the time when operation will be finished appear in the status bar. Operation starts at the appropriate time. You can see the cooking time counting down in the status bar.

The cooking time has elapsed

A signal sounds. The oven stops heating. You can cancel the audible signal early using the  button.

Correcting or cancelling the end time

You cannot correct the end time once the programme has started. Press the On/Off button to delete all settings.

Dishes

You can use the "Dishes" operating mode to very easily prepare food. The appliance chooses the optimal setting for you.

Selecting and setting food

1. Press the menu button.
2. Use the rotary selector to select "Dishes".
3. Touch the > arrow.
4. Use the rotary selector to select the food you require.
5. Touch the > arrow.

Note: Information regarding the best shelf position, cookware, etc. to use is displayed.
6. Press the Start/Stop button to start.

You are guided through the entire setting process for your chosen food. Always touch the > arrow.

Note: The appliance informs you if the cooking compartment is still too hot for your chosen food.

The setting has ended

A signal sounds. The oven stops heating. You can cancel the audible signal early using the  button.

If you are not satisfied with the cooking result, you can increase the cooking time again. Touch the "Extend cooking time" field. A cooking time is suggested. You can change this if you wish.

If you are satisfied with the cooking result, touch "Finish". "Enjoy your meal" appears in the display.

Cancelling the setting

Press the On/Off button. All settings are deleted. You can implement new settings.

Setting a later end time

For some dishes, it is possible to set a later end time. You can find out how to set a later end time by looking in the time-setting options. → *"Time-setting options" on page 13*

Once you have set an end time, the display shows the waiting time. The status bar shows the time at which operation is to end. None of the settings can be changed. Please remember that easily spoiled foods must not be allowed to remain in the cooking compartment for too long.

Instructions for the dishes

All programmes are designed for cooking on one level. The cooking result may vary according to the size and quality of the food.

Cookware

Use the suggested cookware. All meals have been tested using this cookware. The cooking result may change if you use different cookware.

When cooking in the perforated steam container, also insert the solid steam container at level 1. Dripping liquid is caught.

Amount/weight

Do not fill the food more than 4 cm deep in the accessory.

The total weight must be within the specified weight range.

Cooking time

The displayed temperature may change during the first few minutes, as the heating-up time depends on the temperature of the food and the water, amongst other things.

Preparing vegetables

Do not season vegetables until after cooking.

Preparing cereal products/lentils

Weigh the food and add the correct ratio of water:

Basmati rice 1:1.5

Couscous 1:1

Brown rice 1:1.5

Lentils 1:2

Stir cereal products after cooking. The remaining water is quickly absorbed.

Steaming chicken breast

Do not place chicken breasts on top of each other in the cookware.

Steaming fish

When preparing fish, grease the perforated steam container.

Do not place whole fish or fish fillets on top of each other. Enter the weight of the heaviest fish and choose pieces as similar in size as possible.

Preparing yoghurt

Heat the milk to 90 °C on the hob. Then leave to cool to 40 °C. It is sufficient to heat UHT milk to 40 °C. Stir in 150 g (chilled) yogurt.

Pour into cups or small jars and cover with cling film. Place the cups or jars onto the steamer tray and position as indicated in the table. After preparation, leave the yogurt to cool in the refrigerator.

Making rice pudding

Weigh the rice and add 2.5 times the amount of milk. Ensure the level of rice and milk in the accessory is no higher than 2.5 cm. Stir after cooking. The remaining milk is quickly absorbed.

Making fruit compote

The programme is only suitable for fruits with stones and pips. Weigh the fruit and add approximately 1/3 of the water, and add sugar and spices according to taste.

Sterilising bottles

Always clean the bottles with a bottle brush immediately after use. Then clean them in the dishwasher.

Place the bottles in the perforated steam container so that they do not touch one another.

Dry the bottles with a clean cloth after sterilising. The process corresponds to normal sterilisation by boiling.

Cooking eggs

Pierce the eggs before cooking. Do not place eggs on top of each other.

Table

Follow the instructions for the dishes.

Dish	Notes	Accessories	Level
Steam cauliflower florets*	Florets of equal size	perforated + solid steam container	3 1
Steam broccoli florets*	Florets of equal size	perforated + solid steam container	3 1
Steam green beans*	-	perforated + solid steam container	3 1
Steam sliced carrots*	slices, approx. 3 mm thick	perforated + solid steam container	3 1
Steam frozen mixed vegetables	-	perforated + solid steam container	3 1
Unpeeled boiled potatoes*	medium-sized, dia. 4 - 5 cm	perforated + solid steam container	3 1
Basmati rice	max. 0.75 kg	solid steam container	2
Brown rice	max. 0.75 kg	solid steam container	2
Couscous	max. 0.75 kg	solid steam container	2
Lentils	max. 0.55 kg	solid steam container	2
Reheat cooked side dishes*		solid steam container	2
Steam fresh chicken breast	Total weight 0.2 - 1.5 kg	perforated + solid steam container	3 1
Steam fresh fish fillet	max. 2.5 cm thick	perforated + solid steam container	3 1
Steam whole fresh fish	0.3 - 2 kg	perforated + solid steam container	3 1
Yogurt in glass jars	-	jars + solid steam container	2
Rice pudding	-	solid steam container	2
Fruit compote*	-	solid steam container	2
Sterilising bottles*		solid steam container	2
Soft-boiled eggs*	Eggs, size M, max. 1 kg	perforated + solid steam container	3 1
Hard-boiled eggs*	Eggs, size M, max. 1.8 kg	perforated + solid steam container	3 1



* You can set an end time for this dish

Childproof lock

Your appliance is equipped with a childproof lock so that children cannot switch it on accidentally or change any settings.

Activating and deactivating

You can activate and deactivate the childproof lock when the appliance is switched off.



In each case, press the  button for approx. 4 seconds. A confirmation note appears in the display and the  symbol appears in the status bar.

Note: Despite the childproof lock, you can still switch off the oven using the On/Off button.

Basic settings

There are various settings available to you in order to help use your appliance effectively and simply. You can change these settings as required.

Changing settings

1. Press the "On/off" button.
2. Press the menu button.
The operating modes menu opens.
3. Use the rotary selector to select "Settings".
4. Touch the arrow .
5. Use the rotary selector to change the values.
6. Use the arrow  to change to the next settings, and change them if necessary.
7. Press the menu button to save.
"Save" or "Discard" appears on the display.

List of settings

This list tells you all the basic settings and how to change them. Depending on the model of the appliance you own, the display will show only those settings that apply to your appliance.

You can change the following settings:

Setting	Options
Select language	Additional languages possible
Time of day	Sets the current time
Date	Sets the current date
Water hardness	0 (softened)
	1 (soft)
	2 (medium)
	3 (hard)
	4 (very hard)
Audible signal duration	Short (30 s)
	Medium (1 m)
	Long (5 m)
Button tone	Switched off (button tone still sounds when switching on/off using the "On/off" button)
	Switched on
Display brightness	Can be adjusted to one of five different levels
Clock display	Digital
	Off
Lighting	On during operation
	Off during operation
Operation after switching on	Steam
	Main menu
	Dishes
Night-time dimming	Switched off
	Switched on (display dimmed between 10 p.m. and 5.59 a.m.)

Brand name logo	Display
	Do not display
Fan run-on time	Recommended
	Minimum
Factory settings	Restore
	Do not restore

Note: Changes to the language, button tone and display brightness settings take effect immediately. All other changes take effect after the settings have been saved.

Changing the time

You can change the time in the basic settings.

For example: Changing from summer to winter time.

1. Press the On/Off button.
2. Press the Menu button.
3. Use the rotary selector to select "Settings".
4. Touch the arrow > to move to "Time of day".
5. Use the rotary selector to change the time.
6. Press the Menu button.
Save or Discard appears in the display.

Power cut

Following a long power cut, the settings for initial use are shown in the display.

Reset the language, time and date.

cleaning agents

Appliance exterior (with aluminium front)	Use soapy water and dry with a soft cloth. Mild window cleaning agent - wipe over the aluminium front horizontally and without applying pressure using a soft window cloth or a lint-free microfibre cloth.
Appliance exterior (with stainless steel front)	Use soapy water and dry with a soft cloth. Always remove flecks of limescale, grease, starch and albumin (e.g. egg white) immediately. Special stainless steel cleaning agents can be obtained from the after-sales service or from specialist retailers.
Cooking compartment interior with evaporator dish	Hot, soapy water or a vinegar solution - use the enclosed cleaning sponge or a soft washing-up brush. Caution! The cooking compartment could rust. Do not use steel pads or scourers.
Water tank	Soapy water - do not clean in the dishwasher.
Tank recess	Rub dry after every use
Seal in the water tank lid	Thoroughly dry after every use
Rails	See section: Cleaning the rails
Door panels	See section: Cleaning the door panels Caution! Risk of surface damage After cleaning, wipe the door panels with glass cleaner, then dry. Otherwise, stains will be caused that will not be able to be removed.
Door seal	Hot soapy water
Accessories	Soak in hot soapy water. Clean with a brush or washing-up sponge or in the dishwasher. If the rails are discoloured by starchy foods (e.g. rice), clean them with a vinegar solution.

Cleaning

With good care and cleaning, your appliance will retain its appearance and remain fully functioning for a long time to come. We will explain here how you should correctly care for and clean your appliance.

Warning – Risk of short circuit!

Do not use high-pressure cleaners or steam jet cleaners to clean your appliance.

Caution! **Risk of surface damage**

Do not use

- harsh or abrasive cleaning agents
- oven cleaners
- corrosive or aggressive cleaners, or those containing chlorine
- cleaning agents with a high alcohol content

If such an agent comes into contact with the front of the appliance, wash it off immediately with water.

Caution! **Risk of surface damage**

If descaler comes into contact with the front of the appliance or any other sensitive surfaces, wash it off immediately with water.

Remove food residues from the cooking compartment as soon as the appliance has cooled.

Salts are very corrosive and can cause rust. Remove remains of acidic sauces (ketchup, mustard) or salted food from the cooking compartment immediately after cooling.

Do not use hard scouring pads or cleaning sponges.

Cleaning sponge

The enclosed cleaning sponge is very absorbent. Use the cleaning sponge only for cleaning the cooking compartment and for removing residual water from the evaporator dish.

Wash the cleaning sponge thoroughly before using for the first time. You can wash the cleaning sponge in the washing machine (hot wash).

Microfibre cloth

The honeycomb microfibre cloth is particularly suitable for cleaning sensitive surfaces such as glass, glass ceramic, stainless steel or aluminium (product no. 460 770, also available from our online eShop). It removes liquid and greasy deposits in one go.

Descal

The appliance must be descaled regularly in order for it to continue operating correctly.

There are several steps in the descaling programme. All steps must be completed in full. Only after this is the appliance ready for use again.

Note: If you touch the On/Off button during the descaling programme, the process is interrupted and the appliance switches off. Once the appliance has been switched back on again, it must first be rinsed twice in order to remove any remaining descaling solution from the appliance. The appliance is locked for other applications until the second rinsing cycle is complete.

- Descal (approx. 30 minutes), then empty the evaporator dish and refill the water tank
- First rinsing cycle (20 seconds), then empty the evaporator dish
- Second rinsing cycle (20 seconds), then remove the remaining water

The frequency with which the appliance must be descaled depends on the hardness of the water used. When only five more steam-assisted operations are possible, or fewer, the appliance reminds you to descale it with a message on the display. The number of remaining operations is displayed after the appliance is switched on. You can therefore prepare for the descaling in good time.

Starting

Caution!

- Risk of damage to the appliance: Only use liquid descalers recommended by us for the descaling programme. The time the product needs to work during descaling depends on the type of descaler used. Other descalers may damage the appliance. Descaler order no. 311 680
- Descaling solution: Do not allow any descaling solution or descaler to come into contact with the control panel or other surfaces on the appliance, as this will damage the surfaces. If this does happen, remove the descaling solution immediately with water.

1. Mix 300 ml water with 60 ml liquid descaler to make a descaling solution.
2. Remove the water tank and fill it with descaling solution.
3. Once the water tank has been filled with descaling solution, push it back in again fully.
4. Close the appliance door.
5. Press the On/Off button.
6. Press the menu button.
7. Turn the rotary selector until "Descal" appears.
8. Press the Start/Stop button to start descaling. You can see the remaining time counting down in the status bar. An audible signal will sound once the remaining time has fully elapsed.

First rinsing cycle

1. Remove the descaling solution from the evaporator dish using the cleaning sponge provided.
2. Remove the water tank, rinse thoroughly, fill with water and reinsert.
3. Close the appliance door.
4. Press the Start/Stop button. The appliance is rinsed. The first rinsing cycle ends after around 20 seconds.
5. Open the appliance door.
6. Thoroughly rinse out the cleaning sponge with water.
7. Remove the remaining water in the evaporator dish using the cleaning sponge.
8. Proceed with the second rinsing cycle.

Second rinsing cycle

1. Remove the water tank, rinse thoroughly, fill with water and reinsert.
2. Close the appliance door.
3. Press the Start/Stop button. The appliance is rinsed. The second rinsing cycle ends after around 20 seconds.
4. Remove the remaining water in the evaporator dish using the cleaning sponge.
5. Wipe out the cooking compartment using the cleaning sponge and then dry with a soft cloth.
6. Switch off the appliance. Descaling is complete and the appliance is ready for use again.

Descaling the evaporator dish only

You can also use "Descal" if you do not wish to descale the whole appliance, but only the evaporator dish in the cooking compartment.

The only difference is as follows:

1. Mix 100 ml water with 20 ml liquid descaler to make a descaling solution.
2. Completely fill the evaporator dish with descaling solution.
3. Fill the water tank with water only.
4. Start "Descal" as described.

You can also descale the evaporator dish manually.

Removing and fitting the appliance door

For cleaning purposes and to remove the door panels, you can detach the appliance door.

The appliance door hinges each have a locking lever. When the locking levers are closed (figure 1), the appliance door is secured in place. It cannot be detached.

When the locking levers are open in order to detach the appliance door (figure 2), the hinges are locked. They cannot snap shut.

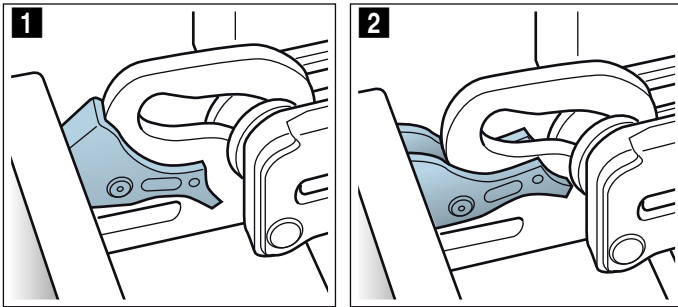

Warning Risk of injury!

- If the hinges are not locked, they can snap shut with great force. Ensure that the locking levers are always fully closed or, when detaching the appliance door, fully open.
- The hinges on the appliance door move when opening and closing the door, and you may be trapped. Keep your hands away from the hinges.

Removing the appliance door

1. Open the appliance door fully and push it in the direction of the appliance.
2. Fold up the two locking levers on the left and right (figure 1).
3. Close the appliance door as far as it goes **a**. With both hands, grip the door on the left- and right-hand side and pull it up and out (figure 2).

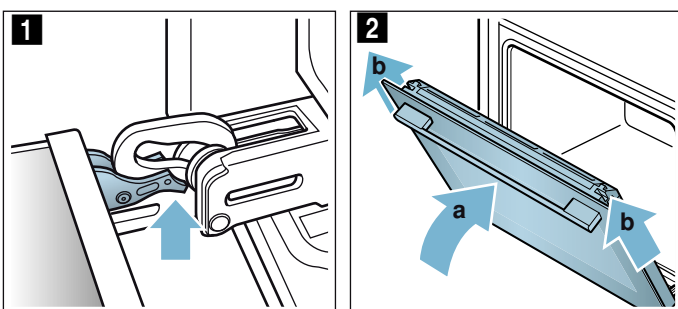

Fitting the appliance door

Reattach the appliance door in the opposite sequence to removal.

1. When attaching the appliance door, ensure that both hinges are inserted straight into the opening (figure 1). Place both hinges at the bottom on the outer panel and use this as a guide. Ensure that the hinges are inserted into the correct opening. You must be able to insert them easily and without resistance. If you can feel any resistance, check that the hinges are inserted into the correct opening.

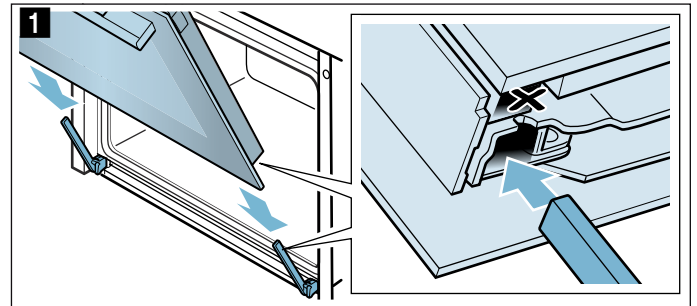

2. Open the appliance door fully. Fold both locking levers closed again (figure 2).

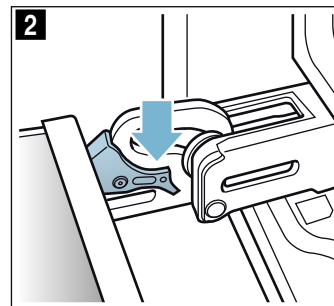

3. Close the cooking compartment door.

Removing and installing the door panels

To facilitate cleaning, you can remove the glass panels from the appliance door.

Removing the door from the appliance

1. Open the appliance door slightly.
2. Press on the right and left side of the cover (figure 1).
3. Remove the cover (figure 2).

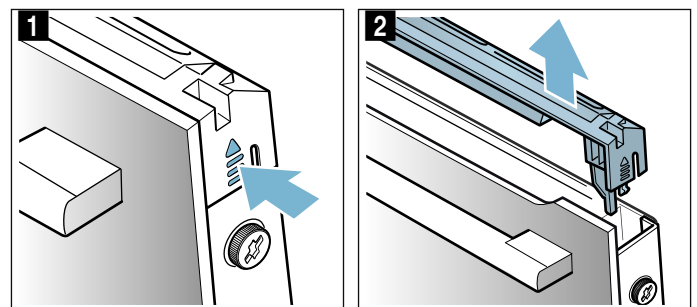

4. Loosen and remove the screws on the left and right of the appliance door (figure 3).

5. Before closing the door again, trap a tea towel which has been folded several times in the door (figure 4). Pull out the front panel upwards and lay it on a flat surface with the door handle facing downwards.

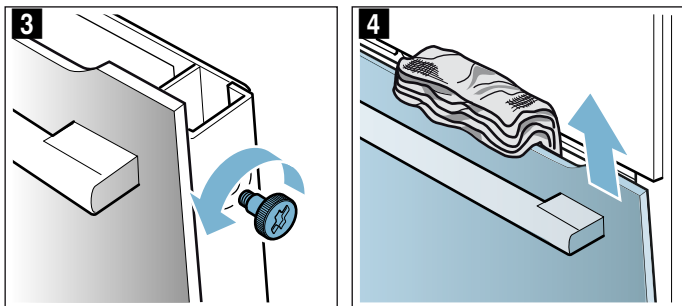

Clean the panels with glass cleaner and a soft cloth.

Warning
Risk of injury!

- Scratched glass in the appliance door may develop into a crack. Do not use a glass scraper, sharp or abrasive cleaning aids or detergents.
- The hinges on the appliance door move when opening and closing the door, and you may be trapped. Keep your hands away from the hinges.

Fitting the door on the appliance

1. Insert the front panel at the bottom into the retainers (figure 1).
2. Close the front panel until both upper hooks are opposite the opening (figure 2).

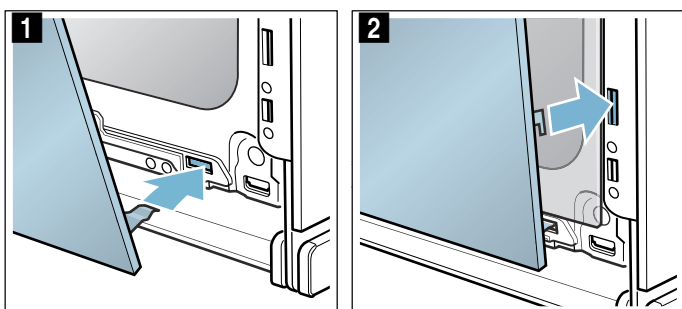

3. Press the front panel at the bottom until it clicks audibly into place (figure 3).
4. Open the appliance door again slightly and remove the tea towel.
5. Screw both screws back in on the left and right.
6. Put the cover back in place and press on it until it clicks audibly into place (figure 4).

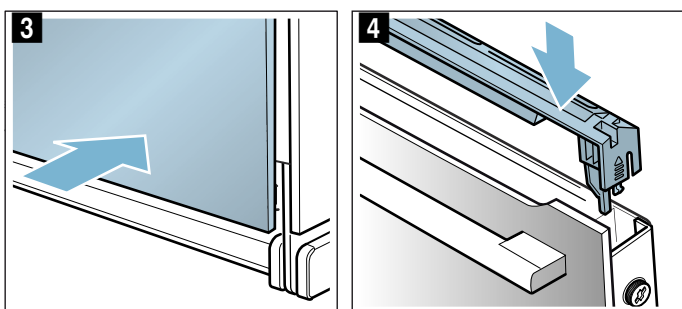

7. Close the appliance door.

Caution!

Do not use the cooking compartment again until the panels have been correctly fitted.

Cleaning the rails

The rails can be removed for cleaning.

Warning – Risk of burning due to hot components in the cooking compartment!

Wait until the cooking compartment has cooled down.

Detaching the rails

Note: Swing the front of the rail as far as possible (until you feel resistance), otherwise the appliance side panel may become bent.

1. Carefully press the front of the rail upwards until it becomes detached, and release it from the holder at the side (fig. 1).
2. Detach the rail from the holder and remove it (fig. 2).

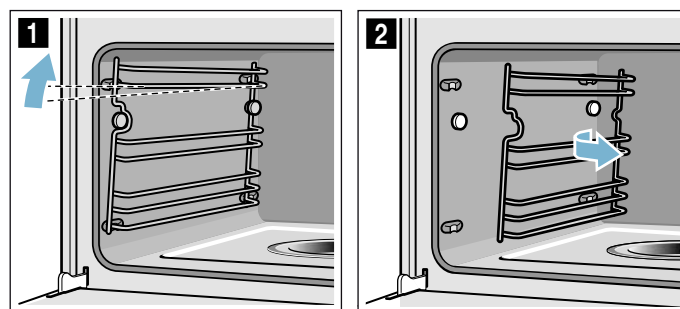

3. Clean the rails with washing-up liquid and a sponge/brush or
Clean the rails in the dishwasher.

Attaching the rails

1. Position the rail so that the indentations are facing upwards.
2. Hook the rail in at the back and push it towards the rear until it engages (fig. 3).
3. Hook the front of the rail onto the holder and press down until it engages and is fixed level in place in the appliance once more (fig. 4).

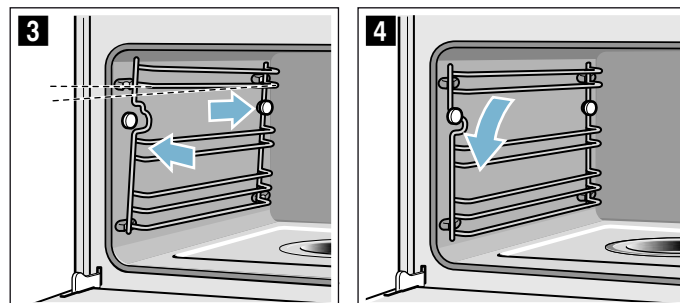

Each set of rails only fits on one side.

Trouble shooting

If a fault occurs, there is often a simple explanation. Before calling the after-sales service, please refer to the fault table and attempt to correct the fault yourself.

Tip: If a meal does not turn out exactly as you wanted, refer to the "Tested for you in our cooking studio" section. Here, you will find plenty of cooking tips and notes.

Fault table

If an error message beginning with 'E' is shown, e.g. E0111, switch the appliance off and then on again. If

Warning – Risk of electric shock!

Incorrect repairs are dangerous. Repairs may only be carried out and damaged power cables replaced by one of our trained after-sales technicians. If the appliance is defective, unplug the appliance from the mains or switch off the circuit breaker in the fuse box. Contact the after-sales service.

this message appears again, contact the after-sales service.

Fault	Possible cause	Information/remedial action
The appliance does not work	The fuse is faulty	Check in the fuse box to make sure that the fuse for the appliance is in working order
	Power cut	Check whether other kitchen appliances are working
Although the appliance is switched on, it cannot be operated; the  symbol is shown in the display	The child lock is activated	Press and hold the  button until the  symbol goes out
The cooking compartment does not heat and "Demo mode on" is shown in the display	The appliance is in demo mode	Switch off the fuse in the fuse box and switch it back on again after approx. 10 seconds. Switch on the appliance and select "Demo mode off" in the settings.
The appliance cannot be started	The appliance door is not fully closed	Close the appliance door
	The appliance is not switched off	Switch the appliance off and back on again
The appliance is prompting you to wipe down the cooking compartment and fill the water tank	The power supply has been disconnected or the appliance has been switched off during the descaling process	Once the appliance is switched on again, rinse it twice
After switching on an operating mode, a message is shown on the display which indicates that the temperature is too high	The appliance has not cooled down sufficiently	Allow the appliance to cool down and switch the operating mode on again
The appliance prompts you to descale without the counter appearing beforehand	The set water hardness range is too low	Carry out descaling Check the set water hardness range and adjust it, if necessary
Buttons flash	Normal occurrence caused by condensation behind the control panel	As soon as the condensation has evaporated, the buttons no longer flash
Liquid in the evaporator dish has fully evaporated, even though the water tank is full	The water tank has not been inserted properly	Push in the water tank completely until you feel it engage
	The feed line to the water tank is blocked	Descale the appliance Check the set water hardness range and change it, if necessary
The water tank empties for no discernible reason. The evaporator dish overflows	The water tank was not closed properly	Close the lid until you feel it lock into place
	The tank lid seal is dirty	Clean the seal
	The tank lid seal is faulty	Obtain a new water tank from the after-sales service
The appliance's display prompts you to fill up the water tank even though it is full.	The water tank has not been inserted properly	Push in the water tank completely until you feel it engage
	The detection system is not working	Call the after-sales service
The appliance's display prompts you to fill up the water tank even though it is not yet empty, or the water tank is empty but no corresponding message appears on the display	The water tank is dirty. The moving water level indicators are jammed	Shake and clean the water tank. If the jammed parts cannot be freed, obtain a new water tank from the after-sales service

The question "Fill the water tank?" appears in the display while the operation is running	Water tank half filled	No remedial action required, operation continues
"Appliance heating" appears on the display but the appliance is not reaching the selected temperature	Automatic calibration values not optimal	Restore the appliance's factory settings and repeat the steps required for first-time operation → "Basic settings" on page 17 → "Before using for the first time" on page 10 The next time you use the steam function at 100 °C, calibration will run automatically and more steam will be produced
When you cook with steam, a lot of steam is produced	The appliance is being automatically calibrated	Normal procedure
When cooking with steam, a lot of steam is produced repeatedly	The appliance is unable to calibrate itself automatically if cooking times are too short	Reset the appliance to the factory settings and repeat the calibration process
Steam escapes from the ventilation slots during cooking	Normal procedure	Not possible

Replacing the cooking compartment bulb

Heat-resistant 230 V/25 W halogen bulbs with seals are available from the after-sales service. Please specify the E number and FD number of your appliance.

⚠ Warning – Risk of electric shock!

When replacing the cooking compartment bulb, the bulb socket contacts are live. Before replacing the bulb, unplug the appliance from the mains or switch off the circuit breaker in the fuse box.

⚠ Warning – Risk of burns!

The appliance becomes very hot. Never touch the interior surfaces of the cooking compartment or the heating elements. Always allow the appliance to cool down. Keep children at a safe distance.

1. Unplug the appliance from the mains or switch off the circuit breaker in the fuse box.
2. Turn the cover anti-clockwise to remove it.
3. Remove the bulb.
Insert the new bulb, making sure that the pins are in the correct position. Push the bulb in firmly.

Caution!

Only operate the appliance with the glass cover and seals.

4. Slide the new seals and the clamping ring onto the glass cover in the right order.

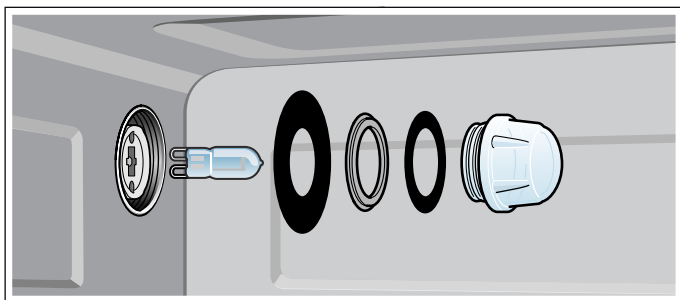

5. Screw the glass cover with the seals back on again.
6. Connect the appliance to the power supply and carry out commissioning again.

Replacing the glass cover or seals

If the glass cover for the halogen bulb or the seals are damaged, they must be replaced. A new glass cover can be obtained from the after-sales service. Please specify the E number and FD number of your appliance.

Changing the door seal

If the seal around the outside of the cooking compartment is faulty, it must be replaced. Replacement seals for your appliance can be obtained from the after-sales service. Please specify the E number and FD number of your appliance.

1. Open the appliance door.
2. Pull off the old seal.
3. Push in the new door seal at one point and pull it in all the way round. The joint must be at the side.
4. Check again that the seal is correctly fitted in the corners.

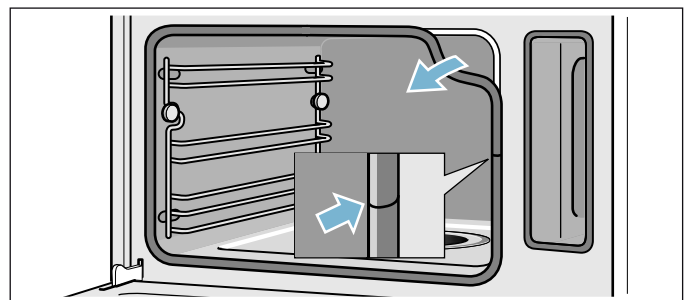

Customer service

Our after-sales service is there for you if your appliance needs to be repaired. We will always find an appropriate solution, also in order to avoid after-sales personnel having to make unnecessary visits.

E number and FD number

When calling us, please quote the full product number (E no.) and the production number (FD no.) so that we can provide you with the correct advice. The rating plate bearing these numbers can be found when you open the appliance door.

On some appliances with a steam-assisted cooking function, you will find the rating plate behind the control panel.

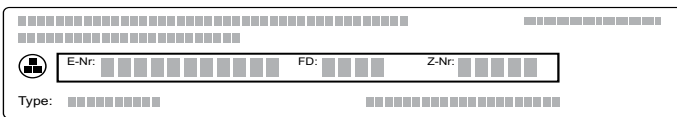

To save time, you can make a note of the numbers for your appliance and the telephone number of the after-sales service in the space below in case you need them.

E no.	FD no.

After-sales service

Please note that a visit from an after-sales service engineer is not free of charge in the event that the appliance has been misused, even during the warranty period.

Please find the contact data of all countries in the enclosed customer service list.

To book an engineer visit and product advice

- GB** 0344 892 8999
Calls charged at local or mobile rate.
- IE** 01450 2655
0.03 € per minute at peak. Off peak 0.0088 € per minute.

Rely on the professionalism of the manufacturer. You can therefore be sure that the repair is carried out by trained service technicians who carry original spare parts for your appliances.

Settings table and tips

Steaming is a particularly gentle way of cooking food. The steam surrounds the dish thereby preventing a loss of nutrients from the food. Cooking takes place without excess pressure. As a result, the shape, colour and typical aroma of the dishes are retained.

The tables contain a selection of dishes which are particularly suitable for your steam oven. You can find out which heating type, accessories, temperature and cooking time are best to select. Unless otherwise stated, the information given applies to inserting accessories when the appliance is cold.

Accessories

Use the accessories provided.

When steaming in the perforated steam container, always insert the solid steam container underneath. Dripping liquid is caught.

Ovenware

When using ovenware, always place it in the middle of the perforated steam container.

Ovenware must be heat and steam resistant. Cooking times are increased if thick-sided ovenware is used.

Food which would normally be prepared in a bain-marie should always be covered with foil (e.g. when melting chocolate).

Cooking time and quantity

The cooking times when steaming depend on the item size, but do not depend on the total quantity. The appliance can steam food to a maximum of 2 kg.

Follow the unit sizes given in the tables. The cooking time is reduced for smaller pieces and increased for larger ones. Cooking time is also influenced by the quality and ripeness of the food. The values quoted can therefore only serve as a guideline.

Distributing food evenly

Always distribute the food evenly in the ovenware. It will not cook evenly if the layers are of different depths.

Pressure-sensitive food

When layering delicate foods in the steam container, do not pile them too high. You should ideally use two steam containers.

Cooking a menu

With steam, you can cook a whole menu at once, without the different flavours mixing. Place the food with the longest cooking time in the appliance first and delay the rest until the appropriate time. This means that all the food will be ready at the same time.

The overall cooking time is extended with menu cooking, as a little steam escapes each time the appliance door is opened and has to be reheated.

Vegetables

Place the vegetables in the perforated steam container and insert at level 3. Always insert the solid steam container underneath at level 1. Any dripping liquid will be caught.

Food	Size	Accessories	Type of heating	Temperature in °C	Cooking time in min.
Artichokes	whole	perforated + solid	Steaming	100	30 - 35
Cauliflower	whole	perforated + solid	Steaming	100	25 - 35
Cauliflower	florets	perforated + solid	Steaming	100	10 - 15
Broccoli	florets	perforated + solid	Steaming	100	8 - 10
Peas	-	perforated + solid	Steaming	100	5 - 10
Fennel	sliced	perforated + solid	Steaming	100	10 - 14
Vegetable flan	-	1.5 l bain-marie dish + wire rack at level 2	Steaming	100	50 - 70
Green beans	-	perforated + solid	Steaming	100	20 - 25
Carrots	sliced	perforated + solid	Steaming	100	10 - 20
Kohlrabi	sliced	perforated + solid	Steaming	100	20 - 25
Leek	sliced	perforated + solid	Steaming	100	6 - 9
Sweetcorn	whole	perforated + solid	Steaming	100	25 - 35
Swiss chard*	shredded	perforated + solid	Steaming	100	8 - 10
Green asparagus*	whole	perforated + solid	Steaming	100	7 - 12
White asparagus*	whole	perforated + solid	Steaming	100	10 - 15
Spinach*	-	perforated + solid	Steaming	100	2 - 3
Romanesco	florets	perforated + solid	Steaming	100	8 - 10
Brussels sprouts	florets	perforated + solid	Steaming	100	20 - 30
Beetroot	whole	perforated + solid	Steaming	100	40 - 50
Red cabbage	shredded	perforated + solid	Steaming	100	30 - 35
White cabbage	shredded	perforated + solid	Steaming	100	25 - 35
Courgette	sliced	perforated + solid	Steaming	100	3 - 4
Mangetout	-	perforated + solid	Steaming	100	8 - 12

* Preheat the appliance

Side dishes and pulses

Add water or liquid in the proportion specified. For example: 1:1.5 = add 150 ml liquid for every 100 g rice.

You may select any shelf position you wish for the solid steam container.

Food	Ratio	Accessories	Level	Type of heating	Temperature in °C	Cooking time in min.
Unpeeled boiled potatoes (medium size)	-	perforated + solid	3 1	Steaming	100	35 - 45
Boiled potatoes (quartered)	-	perforated + solid	3 1	Steaming	100	20 - 25
Brown rice	1:1.5	solid	-	Steaming	100	35 - 45
Long grain rice	1:1.5	solid	-	Steaming	100	20 - 30
Basmati rice	1:1.5	solid	-	Steaming	100	20 - 30
Parboiled rice	1:1.5	solid	-	Steaming	100	15 - 20
Risotto	1:2	solid	-	Steaming	100	30 - 35

Food	Ratio	Accessories	Level	Type of heating	Temperature in °C	Cooking time in min.
Lentils	1:2	solid	-	Steaming	100	35 - 50
Canellini beans, pre-softened	1:2	solid	-	Steaming	100	65 - 75
Couscous	1:1	solid	-	Steaming	100	6 - 10
Unripe spelt grain, coarse ground	1:2.5	solid	-	Steaming	100	15 - 20
Millet, whole	1:2.5	solid	-	Steaming	100	25 - 35
Wheat, whole	1:1	solid	-	Steaming	100	60 - 70
Dumplings	-	perforated + solid	3 1	Steaming	95	20 - 25

Poultry and meat

Poultry

Food	Amount	Accessories	Height	Heating type	Temperature in °C	Cooking time in min.
Chicken breast	0.15 kg each	solid	2	Steam	100	15 - 25
Duck breast*	0.35 kg each	solid	2	Steam	100	12 - 18
* Sear first and wrap in foil						

Beef

Food	Amount	Accessories	Height	Heating type	Temperature in °C	Cooking time in min.
Thin slice of sirloin, medium*	1 kg	solid	2	Steam	100	25 - 35
Thick piece of sirloin, medium*	1 kg	perforated + solid	3 1	Steam	100	30 - 40
* Sear first and wrap in foil						

Pork

Food	Amount	Accessories	Level	Type of heating	Temperature in °C	Cooking time in min.
Fillet of pork	0.5 kg	solid	2	Steaming	100	16 - 20
Pork medallions*	approx. 3 cm thick	solid	2	Steaming	100	10 - 12
Smoked pork ribs	sliced	solid	2	Steaming	100	15 - 20
* Sear first and wrap in foil						

Sausages

Food	Accessories	Level	Type of heating	Temperature in °C	Cooking time in min.
Wiener sausages	perforated + solid	3 1	Steaming	80 - 90	12 - 18
Bavarian veal sausages	perforated + solid	3 1	Steaming	80 - 90	20 - 25

Fish

Food	Amount	Accessories	Height	Heating type	Temperature in °C	Cooking time in min.
Sea bream, whole	0.3 kg each	perforated + solid	3 1	Steam	80 - 90	15 - 25
Sea bream fillet	0.15 kg each	perforated + solid	3 1	Steam	80 - 90	10 - 20
Fish terrine	1.5 l bain-marie dish	solid	2	Steam	70 - 80	40 - 80
Trout, whole	0.2 kg each	perforated + solid	3 1	Steam	80 - 90	12 - 15
Cod fillet	0.15 kg each	perforated + solid	3 1	Steam	80 - 90	10 - 14
Salmon fillet	0.15 kg each	perforated + solid	3 1	Steam	100	8 - 10
Mussels	1.5 kg	solid	2	Steam	100	10 - 15
Ocean perch fillet	0.15 kg each	perforated + solid	3 1	Steam	80 - 90	10 - 20
Sole rolls, stuffed		perforated + solid	3 1	Steam	80 - 90	10 - 20

Soup vegetables, miscellaneous

Food	Accessories	Height	Heating type	Temperature in °C	Cooking time in min.
Royale (egg custard)	solid	2	Steam	90	15 - 20
Semolina dumplings	perforated + solid	3 1	Steam	90 - 95	7 - 10
Hard-boiled eggs (Size M, max. 1.8 kg)	perforated + solid	3 1	Steam	100	10 - 12
Soft-boiled eggs (Size M, max. 1 kg)	perforated + solid	3 1	Steam	100	6 - 8

Dessert, compote

Compote

Weigh the fruit and add approximately $\frac{1}{3}$ of the water, then add sugar and spices according to taste.

Rice pudding

Weigh the rice and add 2.5 times the amount of milk. Ensure the level of rice and milk in the accessory is no higher than 2.5 cm. Stir after cooking. The remaining milk is quickly absorbed.

Yogurt

Heat the milk to 90 °C on the hob. Then leave to cool to 40 °C. It is sufficient to heat UHT milk to 40 °C.

Stir in 150 g (chilled) yogurt. Pour into cups or small jars and cover with cling film. Place the cups or glasses onto the steamer tray and set as indicated in the table.

After preparation, leave the yogurt to cool in the refrigerator.

Food	Accessories	Type of heating	Temperature in °C	Cooking time in min.
Yeast dumplings	solid	Steaming	100	20 - 25
Crème caramel	small moulds + perforated	Steaming	80	15 - 20
Rice pudding*	solid	Steaming	100	25 - 35
Yoghurt*	Portion-sized glasses + perforated	Steaming	40	300 - 360
Apple compote	solid	Steaming	100	10 - 15
Pear compote	solid	Steaming	100	10 - 15
Cherry compote	solid	Steaming	100	10 - 15
Rhubarb compote	solid	Steaming	100	10 - 15
Plum compote	solid	Steaming	100	15 - 20

* You can also use the appropriate programme (see section: Automatic programmes)

Reheating food

Using Reheat, dishes can be gently reheated. They taste and look like they have been freshly prepared.

Food	Accessories	Level	Type of heating	Temperature in °C	Cooking time in min.
Vegetables	solid steam container	3	Reheating	100	12 - 15
Pasta, potatoes, rice	solid steam container	3	Reheating	100	5 - 25

Defrosting

The steam function "Defrost" is suitable for defrosting frozen fruit and vegetables. It is best to allow poultry, meat and fish to defrost in the refrigerator. To defrost the frozen food, remove it from its packaging. Place frozen fruit and vegetables into the steaming pan with the perforated base, and place the steaming pan with the unperforated base underneath. This keeps the food away from the water that forms as it defrosts, and allows this water to be collected as it drips down. For frozen food that needs to retain liquid when it is cooked, e.g. creamed spinach, use the steaming pan with the unperforated base or cookware placed on the wire rack.

The times specified in the table are intended as a guide. They are dependent on the quality, freezing temperature (-18 °C) and composition of the food. Time ranges are specified. Set the shortest time initially, and then extend the time if necessary.

Tip: Food that has been frozen in thinner pieces or in portions defrosts more quickly than food items frozen in a block.

Food	Amount	Accessories	Level	Temperature in °C	Cooking time in min.
Berries	0.5 kg	perforated + solid	3 1	50 - 55	15 - 20
Vegetables	0.5 kg	perforated + solid	3 1	40 - 50	15 - 50

Prove dough

When the Prove dough type of heating is used, dough proves considerably more quickly than at room temperature.

You may select any shelf position you wish for the wire rack or place the wire rack carefully on the cooking compartment floor.

Caution: Do not scratch the cooking compartment floor.

Place the dough bowl on the wire rack. Do not cover the dough.

Food	Amount	Accessories	Temperature in °C	Cooking time in min.
Yeast dough	1 kg	Bowl + wire rack	35	20 - 30

Extracting juice

Before juicing, place the berries in a bowl and sprinkle with sugar. Leave to stand for at least one hour to draw out the juice.

Pour the berries into the perforated steam container and insert at level 3. Insert the solid steam container at level 1 to catch the juice.

Finally, place the berries in a cloth and squeeze out the rest of the juice.

Food	Accessories	Height	Heating type	Temperature in °C	Cooking time in min.
Raspberries	perforated + solid	3 1	Steam	100	30 - 45
Redcurrants	perforated + solid	3 1	Steam	100	40 - 50

Preserving

Preserve food which is as fresh as possible. When foods are stored for a relatively long period, their vitamin content is reduced and they ferment and spoil more easily.

Only use fruit and vegetables which are in perfect condition.

The following foods cannot be preserved with your appliance:

Contents of tins, meat, fish or pastry dough.

Check preserving jars, rubber rings, clips and springs.

Clean rubber rings and jars thoroughly with hot water. The "Sterilise bottles" programme is also suitable for cleaning jars.

Place the jars into the perforated steam container. They must not touch each other.

After the specified cooking time, open the appliance door.

Do not remove the preserving jars from the appliance until they have completely cooled down.

Food	Accessories	Height	Heating type	Temperature in °C	Cooking time in min.
Vegetables	1-litre preserving jars	2	Steam	100	30 - 120
Stone fruits	1-litre preserving jars	2	Steam	100	25 - 30
Pip fruits	1-litre preserving jars	2	Steam	100	25 - 30

Frozen products

Observe the manufacturer's instructions on the packaging.

The cooking times indicated apply to dishes placed in a cold cooking compartment.

Food	Accessories	Level	Type of heating	Temperature in °C	Cooking time in min.
Pasta, fresh, refrigerated*	solid	2	Steaming	100	5 - 10
Trout	perforated + solid	3 1	Steaming	80 - 100	20 - 25
Salmon fillet	perforated + solid	3 1	Steaming	80 - 100	20 - 25
Broccoli	perforated + solid	3 1	Steaming	100	6 - 10
Cauliflower	perforated + solid	3 1	Steaming	100	5 - 8
Beans	perforated + solid	3 1	Steaming	100	6 - 10
Peas	perforated + solid	3 1	Steaming	100	5 - 12
Carrots	perforated + solid	3 1	Steaming	100	4 - 6
Mixed vegetables	perforated + solid	3 1	Steaming	100	6 - 10
Brussels sprouts	perforated + solid	3 1	Steaming	100	5 - 10

* Add a little liquid

Test dishes

These tables have been produced for test institutes to facilitate the inspection and testing of the various appliances.

Test dishes in accordance with EN 60350-1.

Food	Accessories	Level	Type of heating	Temperature in °C	Cooking time in min.
Broccoli (Steam distribution)	perforated + solid	3 1	Steaming	100	7 - 9
Broccoli (Steam supply)	perforated + solid	3 1	Steaming	100	7 - 9
Peas* (Maximum load)	perforated + solid	3 1	Steaming	100	5 - 12

* Spread out 2.0 kg peas evenly in the container.

BSH Hausgeräte GmbH
Carl-Wery-Str. 34, 81739 München
GERMANY

siemens-home.bsh-group.com

Manufactured by BSH Hausgeräte GmbH under Trademark License of Siemens AG



9001365536
980201