



BOSCH



Register your
new device on
MyBosch now and
get free benefits:
**[bosch-home.com/
welcome](https://bosch-home.com/welcome)**











Extractor hood

DDD96AM60, DDD97BM69, DDD97BM60B

[en] Instruction manual

Extractor hood

Table of contents

| | |
|---|-----------|
|  Intended use | 3 |
|  Important safety information | 4 |
|  Environmental protection | 6 |
| Saving energy | 6 |
| Environmentally-friendly disposal | 6 |
|  Operating modes | 6 |
| Exhaust air mode | 6 |
| Air recirculation | 6 |
|  Getting to know your appliance | 7 |
| Control panel | 7 |
|  Before using for the first time | 7 |
| Initial use | 7 |
|  Operating the appliance | 8 |
| Extending/retracting the appliance | 8 |
| Setting the fan | 8 |
| Intensive setting | 8 |
| Fan run-on time | 8 |
| Lighting | 8 |
|  Cleaning and maintenance | 9 |
| Saturation display | 9 |
| Resetting the saturation displays | 11 |
|  Trouble shooting | 11 |
|  Customer service | 12 |
|  Accessories | 12 |

Additional information on products, accessories, replacement parts and services can be found at www.bosch-home.com and in the online shop www.bosch-eshop.com

Intended use

Read these instructions carefully. Only then will you be able to operate your appliance safely and correctly. Retain the instruction manual and installation instructions for future use or for subsequent owners.

The appliance can only be used safely if it is correctly installed according to the safety instructions. The installer is responsible for ensuring that the appliance works perfectly at its installation location.

This appliance is intended for domestic use and the household environment only. The appliance is not intended for use outside. Do not leave the appliance unattended during operation. The manufacturer is not liable for damage which is caused by improper use or incorrect operation.

This appliance is intended for use up to a maximum height of 2000 metres above sea level.

When conveying the exhaust air, official and legal regulations (e.g. state building regulations) must be followed.

This appliance may be used by children over the age of 8 years old and by persons with reduced physical, sensory or mental capabilities or by persons with a lack of experience or knowledge if they are supervised or are instructed by a person responsible for their safety how to use the appliance safely and have understood the associated hazards.

Children must not play with, on, or around the appliance. Children must not clean the appliance or carry out general maintenance unless they are at least 15 years old and are being supervised.

Keep children below the age of 8 years old at a safe distance from the appliance and power cable.

Check the appliance for damage after unpacking it. Do not connect the appliance if it has been damaged in transport.

This appliance is not intended for operation with an external clock timer or a remote control.

Important safety information

Warning – Danger of suffocation!

Packaging material is dangerous to children. Never allow children to play with packaging material.

Warning – Danger of death!

Risk of poisoning from flue gases that are drawn back in.

Always ensure adequate fresh air in the room if the appliance is being operated in exhaust air mode at the same time as room air-dependent heat-producing appliance is being operated.

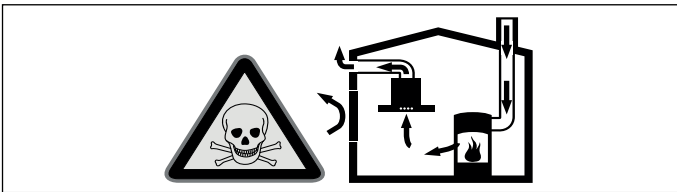

Room air-dependent heat-producing appliances (e.g. gas, oil, wood or coal-operated heaters, continuous flow heaters or water heaters) obtain combustion air from the room in which they are installed and discharge the exhaust gases into the open air through an exhaust gas system (e.g. a chimney).

In combination with an activated vapour extractor hood, room air is extracted from the kitchen and neighbouring rooms - a partial vacuum is produced if not enough fresh air is supplied. Toxic gases from the chimney or the extraction shaft are sucked back into the living space.

- Adequate incoming air must therefore always be ensured.
- An incoming/exhaust air wall box alone will not ensure compliance with the limit.

Safe operation is possible only when the partial vacuum in the place where the heat-producing appliance is installed does not exceed 4 Pa (0.04 mbar). This can be achieved when the air needed for combustion is able to enter through openings that cannot be sealed, for example in doors, windows, incoming/exhaust air wall boxes or by other technical means.

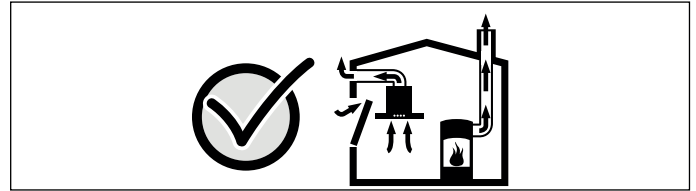

In any case, consult your responsible Master Chimney Sweep. He is able to assess the house's entire ventilation setup and will suggest the suitable ventilation measures to you.

Unrestricted operation is possible if the vapour extractor hood is operated exclusively in the circulating-air mode.

Warning – Risk of fire!

- Fatty deposits in the filters may catch fire. Clean the appliance as described. Comply with the cleaning intervals. Never operate the appliance without the grease filter.
- Grease deposits in the grease filter may catch fire.
 - Clean the grease filter at least once a month.**
 - Never operate the appliance without the grease filter.
- Non-regenerable activated charcoal filters may catch fire in the oven. Never try to regenerate non-regenerable activated charcoal filters. Only regenerate regenerable activated charcoal filters.
- Grease deposits in the grease filter may catch fire. Never work with naked flames close to the appliance (e.g. flambéing). Do not install the appliance near a heat-producing appliance for solid fuel (e.g. wood or coal) unless a closed, non-removable cover is available. There must be no flying sparks.
- Hot oil and fat can ignite very quickly. Never leave hot fat or oil unattended. Never use water to put out burning oil or fat. Switch off the hotplate. Extinguish flames carefully using a lid, fire blanket or something similar.
- When gas burners are in operation without any cookware placed on them, they can build up a lot of heat. A ventilation appliance installed above the cooker may become damaged or catch fire. Only operate the gas burners with cookware on them.

- Operating multiple gas hotplates at the same time generates a great deal of heat. The ventilation appliance may become damaged or catch fire. The ventilation appliance must only be combined with gas hotplates that do not exceed the following values:
 - Maximum five single burners
 The ventilation appliance must only be combined with 75 cm gas hotplates that do not exceed the following values:
 - Total maximum output: 11.9 kW
 - Total maximum output of rear hobs: 4.7 kW
 - Maximum output of wok: 4.2 kW
 The ventilation appliance must only be combined with 90 cm gas hotplates that do not exceed the following values:
 - Total maximum output: 13.7 kW
 - Total maximum output of rear hobs: 4.7 kW
 - Maximum output of wok: 6 kW

⚠ Warning – Risk of burns!

The accessible parts become very hot when in operation. Never touch hot parts. Keep children at a safe distance.

⚠ Warning – Risk of injury!

- Components inside the appliance may have sharp edges. Wear protective gloves.
- Items placed on the appliance may fall down. Do not place any objects on the appliance.
- The light emitted by LED lights is very dazzling, and can damage the eyes (risk group 1). Do not look directly into the switched on LED lights for longer than 100 seconds.
- Risk of jamming when retracting and extending the appliance. Never reach into the moving area of the appliance while it is being retracted or extended. Keep children at a safe distance.
- Cookware set down within the movement area of the appliance can fall over. Hot liquids that pour out can cause injury. Do not set down any cookware within the movement area of the appliance.
- Cookware and cooktops become very hot. Never reach across the hot cooktop or take hold of hot cookware.

⚠ Warning – Risk of electric shock!

- A defective appliance may cause electric shock. Never switch on a defective appliance. Unplug the appliance from the mains or switch off the circuit breaker in the fuse box. Contact the after-sales service.
- Incorrect repairs are dangerous. Repairs may only be carried out and damaged power cables replaced by one of our trained after-sales technicians. If the appliance is defective, unplug the appliance from the mains or switch off the circuit breaker in the fuse box. Contact the after-sales service.
- Do not use any high-pressure cleaners or steam cleaners, which can result in an electric shock.

Causes of damage

Caution!

Risk of damage due to corrosion. Always switch on the appliance while cooking to avoid condensation. Condensate can produce corrosion damage.

Risk of damage due to ingress of humidity into the electronic circuitry. Never clean operator controls with a wet cloth.

Surface damage due to incorrect cleaning. Clean stainless steel surfaces in the direction of the grain only. Do not use any stainless steel cleaners for operator controls.

Surface damage due to strong or abrasive cleaning agents. Never use strong and abrasive cleaning agents.

Items placed on the appliance may damage the appliance or adjacent cooktops when the appliance is extended or retracted. Do not place any objects on the moving parts of the appliance.

Environmental protection

Your new appliance is particularly energy-efficient. Here you can find tips on how to save even more energy when using the appliance, and how to dispose of your appliance properly.

Saving energy

- During cooking, ensure that there is a sufficient supply of air to enable the extractor hood to work efficiently and with a low level of operating noise.
- Adjust the fan speed to the amount of steam produced during cooking. Only use intensive mode when required. The lower the fan speed, the less energy is consumed.
- If cooking produces large amounts of steam, select a higher fan speed in good time. If the cooking steam has already spread around the kitchen, the extractor hood will need to be operated for longer.
- Switch off the extractor hood if you no longer require it.
- Switch off the lighting if you no longer require it.
- Clean and (if required) replace the filter at regular intervals in order to increase the effectiveness of the ventilation system and to prevent the risk of fire.
- Put the lid on to reduce cooking steam and condensation.

Environmentally-friendly disposal

Dispose of packaging in an environmentally-friendly manner.



This appliance is labelled in accordance with European Directive 2012/19/EU concerning used electrical and electronic appliances (waste electrical and electronic equipment - WEEE). The guideline determines the framework for the return and recycling of used appliances as applicable throughout the EU.

Operating modes

Exhaust air mode



The air which is drawn in is cleaned by the grease filters and conveyed to the exterior by a pipe system.

Note: The air must not be discharged into a flue that is used for exhausting fumes from appliances burning gas or other fuels (not applicable to appliances that only discharge the air back into the room).

- Before conveying the exhaust air into a non-functioning smoke or exhaust gas flue, obtain the consent of the heating engineer responsible.
- If the exhaust air is conveyed through the outer wall, a telescopic wall box should be used.

Air recirculation



The air which is drawn in is cleaned by the grease filters and an activated carbon filter, and is conveyed back into the kitchen.

Note: To bind odours in air recirculation mode, you must install an activated carbon filter. The different options for operating the appliance in air recirculation mode can be found in the brochure. Alternatively, ask your dealer. The required accessories are available from specialist retailers, from customer service or from the Online Shop.

Getting to know your appliance

Here, you can get to know your appliance and receive information about the accessories.

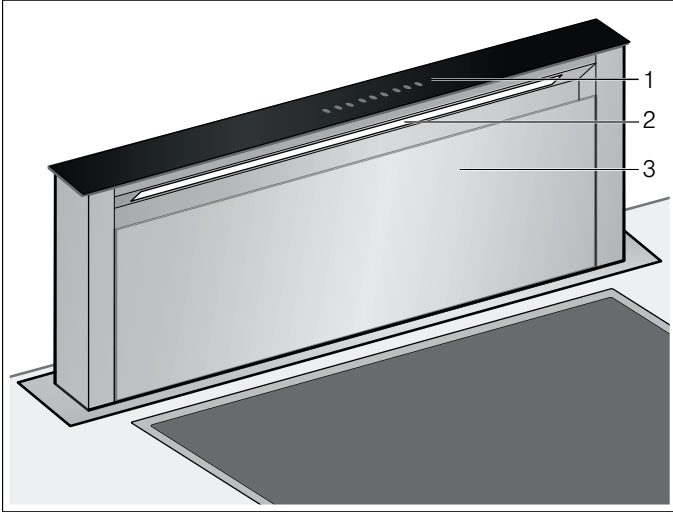





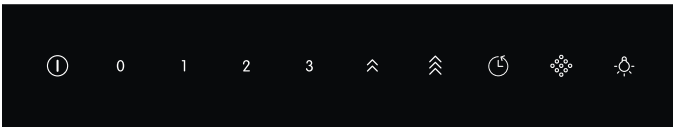

 Control panel

 Lighting

 Filter cover

Control panel



| Symbol | Explanation |
|---|---|
|  | Retracts/extends the appliance, switches the fan on/off |
| 0 | Switches on the fan |
| 1 | Switches on fan setting 1 |
| 2 | Switches on fan setting 2 |
| 3 | Switches on fan setting 3 |
|  | Switches on intensive mode 1 |
|  | Switches on intensive mode 2 |
|  | Switches on the fan run-on |
|  | Saturation indicator |
|  | Switches the lighting on/off |



Before using for the first time

Before you can use your new appliance, you must apply certain settings.



Initial use

Switching over the display for circulating-air mode

For air recirculation mode, the electronic controller's display must be switched over accordingly:

1. Check whether the extractor hood is connected and switched off.
2. Touch .
3. Touch 0.
4. Touch and hold  for at least 3 seconds.
 will flash; the electronic controller has now been switched over to air recirculation mode.

Switching over the display for exhaust air mode

1. Check whether the extractor hood is connected and switched off.
2. Touch .
3. Touch 0.
4. Touch and hold  for at least 3 seconds.
 will be lit; the electronic controller has now been switched over to air extraction mode.

Operating the appliance

This appliance only works when it is completely extended.

Note: Switch on the extractor hood when you start cooking and switch it off again several minutes after you have finished cooking. This is the most effective way of removing the kitchen fumes.

Extending/retracting the appliance

Warning – Risk of injury!

Risk of jamming when retracting and extending the appliance. Never reach into the moving area of the appliance while it is being retracted or extended. Keep children at a safe distance.

Warning – Risk of injury!

Cookware set down within the movement area of the appliance can fall over. Hot liquids that pour out can cause injury. Do not set down any cookware within the movement area of the appliance.

Note: If the appliance has been temporarily disconnected from the power supply, it will retract fully.

Extending the appliance

1. Remove any objects from the appliance's area of movement.
2. Touch .
The appliance will extend fully. The fan will start at setting 2. The lighting will switch on.

Retracting the appliance

Note: The filter cover must be completely closed.

1. Remove any objects from the appliance's area of movement.
2. Touch .
The appliance will retract fully. The lighting and the fan will switch off automatically.

Setting the fan

Note: Always adjust the fan strength to meet current conditions. If there is a large build-up of steam or fumes, select a high fan setting.

Switching on

Touch 1, 2 or 3.



Switching off

Touch 0.

Intensive setting

You can use the intensive setting if there is a large build-up of odours and fumes/vapours.

Switching on

1. Press the  button.
Note: Intensive mode runs for approx. 7 minutes. Once this time has elapsed, the appliance will switch back to fan setting 3.
2. Press the  button.
Note: Intensive mode runs for approx. 7 minutes. Once this time has elapsed, the appliance will switch back to fan setting 3.







Switching off

Touch 1, 2 or 3.

Intensive mode is deactivated.

Fan run-on time

Note: If intensive mode is activated, fan run-on will not be available.

1. Touch .
 and  and fan setting 1 will light up. The fan will continue to run at setting 1 for 10 minutes and then switch off automatically once this time has elapsed. If the lighting has been switched on, this will also be switched off once the run-on time has elapsed.
2. Touch  or .
The fan run-on will end before the remaining run-on time has elapsed.
3. Once the fan run-on has ended, touch .
The appliance will retract fully.

Lighting

The lighting can be switched on and off independently of the ventilation system.

Touch .

Cleaning and maintenance

Warning – Risk of burns!

The appliance becomes hot during operation. Allow the appliance to cool down before cleaning.

Warning – Risk of electric shock!

Penetrating moisture may result in an electric shock. Clean the appliance using a damp cloth only. Before cleaning, pull out the mains plug or switch off the circuit breaker in the fuse box.

Warning – Risk of electric shock!

Do not use any high-pressure cleaners or steam cleaners, which can result in an electric shock.

Warning – Risk of injury!

Components inside the appliance may have sharp edges. Wear protective gloves.

Cleaning agents

To ensure that the different surfaces are not damaged by using the wrong cleaning agent, observe the information in the table. Do not use any of the following:

- Harsh or abrasive cleaning agents,
- Cleaning agents with a high alcohol content,
- Hard scouring pads or cleaning sponges,
- High-pressure cleaners or steam cleaners.

Wash new sponge cloths thoroughly before use.

Follow all instructions and warnings included with the cleaning agents.

| Area | Cleaning agent |
|-----------------------|---|
| Stainless steel | Hot soapy water: Clean with a dish cloth and then dry with a soft cloth. Clean stainless steel surfaces in the grind direction only. Special stainless steel cleaning products are available from our after-sales service or from specialist retailers. Apply a very thin layer of the cleaning product with a soft cloth. |
| Painted surfaces | Hot soapy water: Clean using a damp dish cloth and dry with a soft cloth/towel. Do not use any stainless steel cleaners. |
| Aluminium and plastic | Glass cleaner: Clean with a soft cloth. |

| Area | Cleaning agent |
|----------|---|
| Glass | Glass cleaner: Clean with a soft cloth. Do not use a glass scraper. |
| Controls | Hot soapy water: Clean using a damp dish cloth and dry with a soft cloth/towel. Risk of electric shock caused by penetrating moisture. Risk of damage to the electronics from penetrating moisture. Never clean operating controls with a wet cloth. Do not use any stainless steel cleaners. |

Saturation display

When the metal grease filters or activated charcoal filters are saturated, the corresponding symbol will light up or flash:

- **Metal grease filter:**  will be lit continuously
- **Activated charcoal filter:**  will flash

Do not wait any longer to clean the metal grease filters or replace or regenerate the activated charcoal filters.

Removing metal grease filter

1. Touch .
2. Touch 0.
3. Open the filter cover towards you.

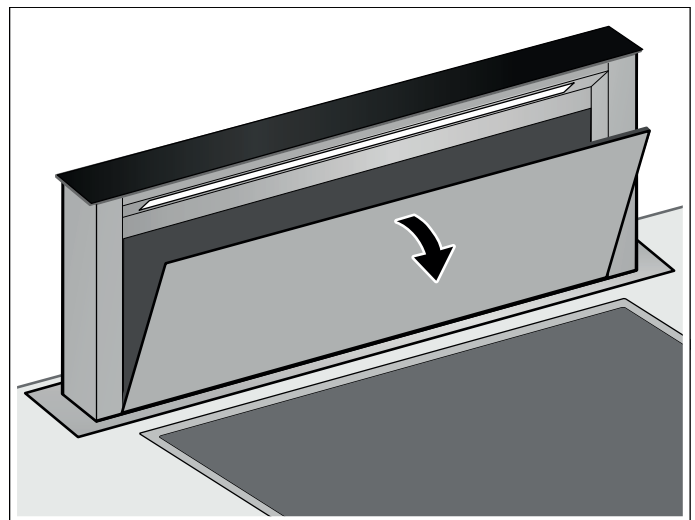

4. Remove the filter from the guide.

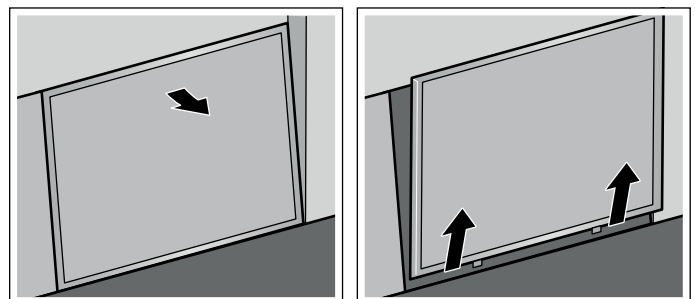

Note: Fat may accumulate in the bottom of the filter holder. Hold the filter holder at an angle to prevent fat from dripping out.

5. Remove the oil collection container.

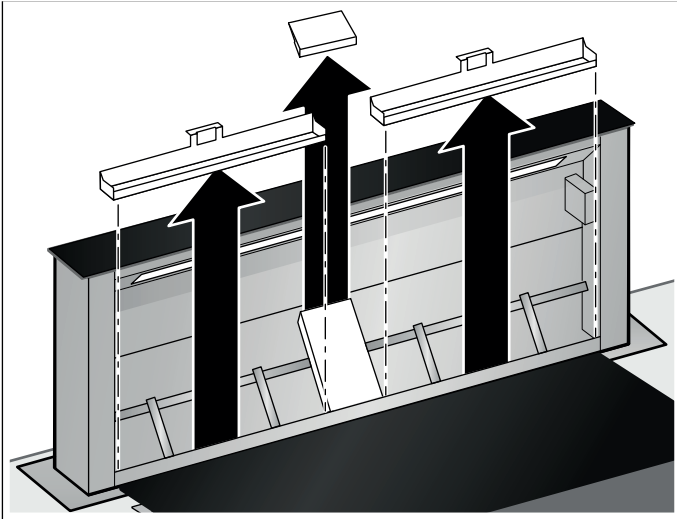

6. For more effective cleaning, remove the protective plate.

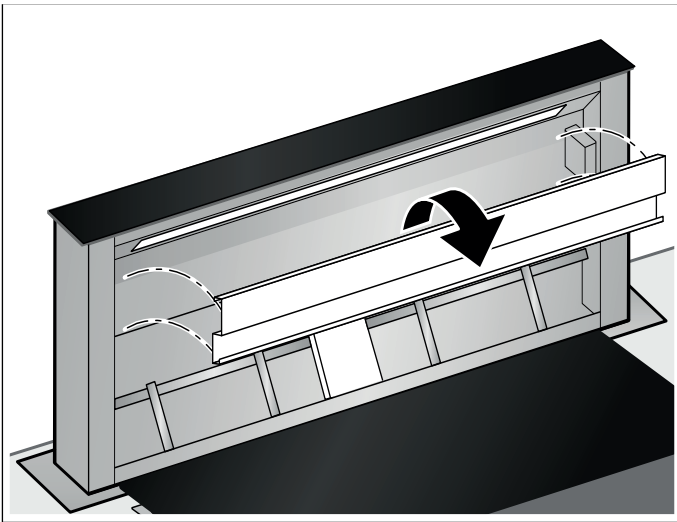

7. Clean the metal grease filter, oil collection container, protective plate and filter cover.
8. After removing the filters, clean the inside of the appliance.

Cleaning the metal grease filter and the oil collection container

⚠ Warning – Risk of fire!

Grease deposits in the grease filter may catch fire.

Clean the grease filter at least once a month.

Never operate the appliance without the grease filter.

Notes

- Do not use any aggressive, acidic or alkaline cleaning agents.
- When cleaning the metal mesh grease filters, also clean the holder for the metal mesh grease filters in the appliance using a damp cloth.
- The metal mesh grease filters can be cleaned in the dishwasher or by hand.

In the dishwasher:

Note: If the metal mesh grease filters are cleaned in the dishwasher, slight discoloration may occur. This has no effect on the function of the metal mesh grease filters.

- Do not clean heavily soiled metal mesh grease filters together with utensils.
- Place the metal mesh grease filters loosely in the dishwasher. The metal mesh grease filters must not be wedged in.

By hand:

Note: You can use a special grease solvent for stubborn dirt. It can be ordered via the Online Shop.

- Soak the metal mesh grease filters in a hot soapy solution.
- Clean the filters with a brush and then rinse them thoroughly.
- Leave the metal mesh grease filters to drain.

Installing the metal mesh grease filter

1. Insert the oil collection container.
2. Insert the metal grease filter.

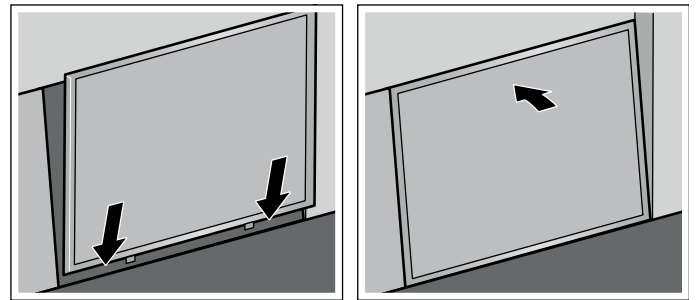

3. Close the filter cover.

Removing the activated charcoal filter (only in circulating-air mode)

The activated charcoal filters must be regenerated or replaced regularly in order to ensure that odours continue to be eliminated effectively. The saturation indicator on your appliance will tell you how frequently this needs to be done.

The activated charcoal filters should be regenerated or replaced at least every 2 months.

1. Remove the metal grease filter.
2. Remove the grille and metal grease filter.

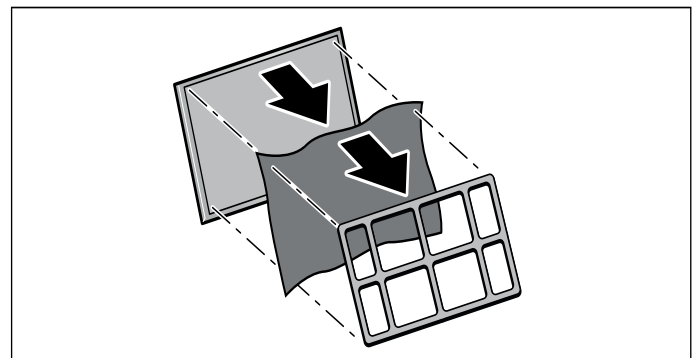

Regenerating the activated charcoal filter

The activated charcoal filters must be regenerated or replaced regularly in order to ensure that odours continue to be eliminated effectively. The saturation indicator on your appliance will tell you how frequently this needs to be done.

The activated charcoal filters should be regenerated or replaced at least every 2 months.

Warning – Risk of fire!

Non-regenerable activated charcoal filters may catch fire in the oven. Never try to regenerate non-regenerable activated charcoal filters. Only regenerate regenerable activated charcoal filters.

Note: Regenerable activated charcoal filters can be regenerated up to ten times.

Note: Odours may develop when regenerating the activated charcoal filter. Make sure that the room is well ventilated and open a window if required.

Note: Regenerated air recirculation filters may be damaged if they fall or are dropped. The damage is not always visible from the outside. Dispose of and replace down any regenerated air recirculation filters that fall or are dropped.

Caution!

Risk of damage due to ingress of moisture into the activated charcoal filter. Never clean activated charcoal filters in the dishwasher or with a wet cloth.

1. If the activated charcoal filter can no longer be regenerated, order a new regenerable activated charcoal filter and use it in place of the old one.
2. Heat the activated charcoal filter for 1 hour at 100 °C in the oven (preheated) using air recirculation mode.
3. Allow the activated charcoal filter to cool down.

Fitting the activated charcoal filter

1. Place the activated charcoal filter onto the metal grease filter.
2. Fix the activated charcoal filter to the grille.

Resetting the saturation displays

Once you have cleaned or replaced the relevant filters, reset the saturation indicator to stop the symbols from flashing.

1. Make sure that the extractor hood has been switched on.
2. Touch and hold  for approx. 3 seconds.

This resets the saturation indicators.

Trouble shooting

Malfunctions often have simple explanations. Please read the following notes before calling the after-sales service.

Warning – Risk of electric shock!

Incorrect repairs are dangerous. Repairs may only be carried out and damaged power cables replaced by one of our trained after-sales technicians. If the appliance is defective, unplug the appliance from the mains or switch off the circuit breaker in the fuse box. Contact the after-sales service.

LED lights

Defective LED lights must only be replaced by the manufacturer, their customer service department or a licensed technician (electrician).

What to do if water gets in

If water gets in to the appliance during cooking or cleaning, proceed as follows:

1. Switch off the appliance.
2. Open the floor cupboard and mop up leaking water.
3. Leave the appliance switched off for 24 hours. After this time, the appliance can be used again without restrictions.

Malfunction table

| Problem | Possible cause | Solution |
|---|--|---|
| The appliance does not work | The plug is not plugged in. | Connect the appliance to the electricity supply |
| | Power cut | Check whether other kitchen appliances are working |
| | Faulty fuse | Check in the fuse box to make sure that the fuse for the appliance is OK |
| Appliance does not switch on. | Filter cover not closed. | Close the filter cover fully. |
| The appliance does not extend or retract. | The circuit breaker in the electrical box is defective. | Call the after-sales service. |
| The button illumination does not work. | The control unit is faulty. | Call the after-sales service. |
| The lighting does not work. | The LED lights are defective. | Call the after-sales service. |
|  or ? will flash on the display. | The grease filter or the activated charcoal filter is saturated. | Clean the filter or replace the activated charcoal filter. → "Cleaning and maintenance" on page 9 |

Customer service

When calling us, please quote the product number (E no.) and the production number (FD no.) so that we can provide you with the correct advice. The rating plate bearing these numbers can be found on the front of the appliance housing underneath the worktop.

You can make a note of the numbers of your appliance and the telephone number of the after-sales service in the space below to save time should it be required.

| E no. | FD no. |
|--|--------|
| | |
| After-sales service  | |

Please be aware that a visit by an after-sales engineer will be charged if a problem turns out to be the result of operator error, even during the warranty period.

Please find the contact data of all countries in the enclosed customer service list.

To book an engineer visit and product advice

- GB** 0344 892 8979
Calls charged at local or mobile rate.
- IE** 01450 2655
0.03 € per minute at peak. Off peak 0.0088 € per minute.

Rely on the professionalism of the manufacturer. You can therefore be sure that the repair is carried out by trained service technicians who carry original spare parts for your appliances.

Accessories

Special accessories

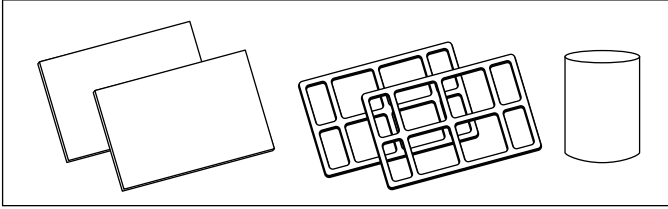
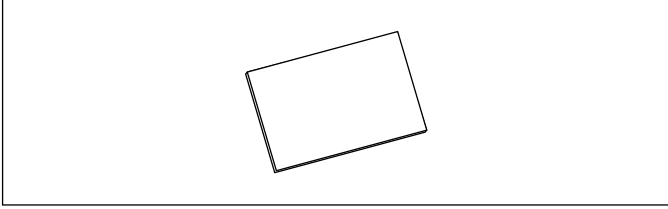
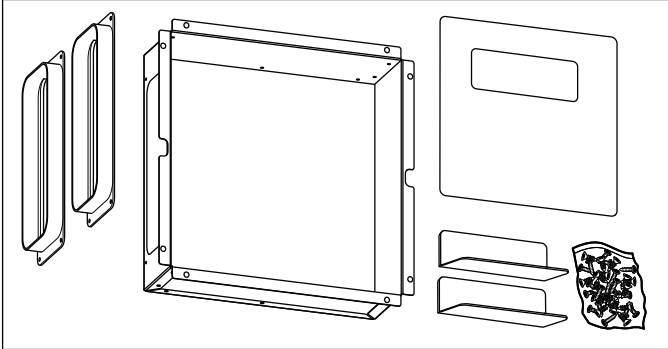
| Accessory | Order number |
|---|--------------|
| Air recirculation accessory set - initial equipment | DSZ9ID0P0 |
|  | |
| Active carbon filter replacement filter | DSZ9ID0Q0 |
|  | |
| Remote installation set | DSZ9ID0M0 |
|  | |



Thank you for buying a Bosch Home Appliance!

Register your new device on MyBosch now and profit directly from:

- **Expert tips & tricks for your appliance**
- **Warranty extension options**
- **Discounts for accessories & spare-parts**
- **Digital manual and all appliance data at hand**
- **Easy access to Bosch Home Appliances Service**

Free and easy registration – also on mobile phones:

www.bosch-home.com/welcome



Looking for help? You 'll find it here.

Expert advice for your Bosch home appliances, need help with problems or a repair from Bosch experts.

Find out everything about the many ways Bosch can support you:

www.bosch-home.com/service

Contact data of all countries are listed in the attached service directory.

Valid within Great Britain:

Imported to Great Britain by

Robert Bosch Hausgeräte GmbH

Carl-Wery-Straße 34

81739 München

Germany

www.bosch-home.com

BSH Home Appliances Ltd.

Grand Union House

Old Wolverton Road

Wolverton, Milton Keynes

MK12 5PT

United Kingdom



9001364763

001217