



Register your new Bosch now:  
[www.bosch-home.com/welcome](http://www.bosch-home.com/welcome)



## Washing machine Top-loader C series



**BOSCH**

**en** Instruction Manual and Installation Instructions

## Your new washing machine

You have chosen a Bosch washing machine.

Please take a few minutes to read and become familiar with the advantages of your washing machine.

To meet the high quality demands required by Bosch, every washing machine that leaves our factory is carefully checked to ensure that it functions correctly and is in perfect condition.

For more information on our products, accessories, replacement parts and services, see our website [www.bosch-home.com](http://www.bosch-home.com) or contact our after-sales service centres.

If the operating and installation instructions describe different models, any differences will be pointed out at the relevant points in the text.



Read these operating and installation instructions before switching on the washing machine.

## Display rules

### **Warning!**

This combination of symbol and signal word indicates a possibly dangerous situation. Not heeding the warning can cause death or injuries.

### **Caution!**

This signal word indicates a possibly dangerous situation. Not heeding the caution can cause property and/or environmental damage.

### **Note/tip**

Information about the optimum use of the appliance/any other useful information.

### **1. 2. 3. / a) b) c)**

The steps are represented by numbers or letters.

■ / -

Lists are represented by a small box or a dash.

# Contents

## **Installing and connecting the appliance** .....4

Included with the appliance: . . . . .	4
Installing the appliance. . . . .	4
Connecting the appliance. . . . .	6
Levelling the appliance. . . . .	9
Before using the appliance for the first time . . . . .	9

## **Quick reference guide** .....10

## **Familiarising yourself with your appliance** .....11

Appliance overview. . . . .	11
Panel . . . . .	12

## **Display** .....13

## **Programme overview** .....15

## **Buttons** .....17

## **Laundry** .....19

Preparing the laundry . . . . .	19
Sorting laundry . . . . .	19

## **Operating the appliance** .....20

Switching on the appliance and setting a programme . . . . .	20
Programme settings . . . . .	20
Placing the laundry into the drum . . . . .	20
Adding detergent and fabric care products . . . . .	21
Starting a programme. . . . .	22
Childproof lock . . . . .	22
Pausing programmes and adding more laundry . . . . .	22
Cancelling the programme . . . . .	22
Resuming the programme when the programme status is Rinse Stop . . . . .	22
Programme end . . . . .	23
Removing laundry and switching off the appliance . . . . .	23

## **Sensors** .....23

Unbalanced load detection system . . . . .	23
Continuous automatic load adjustment function . . . . .	23

## **Cleaning and maintenance** .....24

Cleaning/Maintenance . . . . .	24
Cleaning the drum. . . . .	25
Descaling the appliance . . . . .	25
Cleaning the drain pump. . . . .	25
Cleaning the lint filter. . . . .	26

## **What to do in the event of a fault** .....27

Help with the appliance. . . . .	27
Filter in water supply blocked . . . . .	29

## **Transporting the appliance** ... 30

## **Technical specifications** ..... 31

## **After-sales service** .....32



## Installing and connecting the appliance

### Included with the appliance:

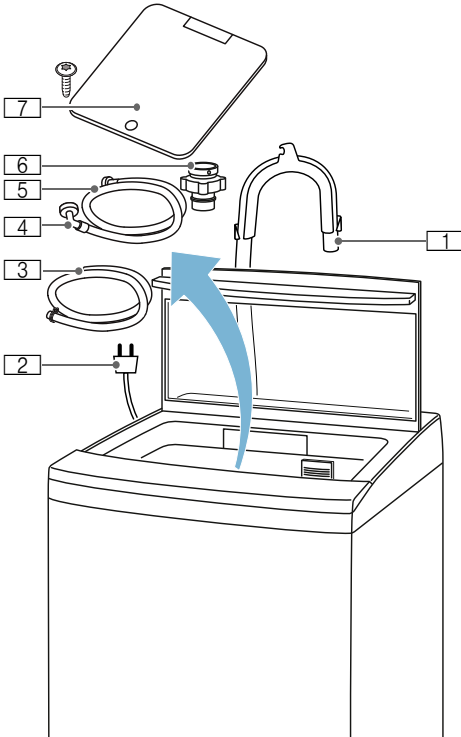

- 1 Water drain hose\*
- 2 Mains cable
- 3 Water drain hose\*
- 4 Water supply hose
- 5 Second water supply hose (identified by a red marking) on models with a hot water supply hose\*

- 6 Snap connector\*
- 7 Bottom plate

\* Depending on the appliance specifications

1. Remove any packaging and protective covers completely from the appliance.
2. Remove the protective film from the control panel.
3. Remove the appliance from the base padding.

**Note:** Operating the appliance on the base padding is strictly forbidden.

4. Open the cover on the appliance and take out all the accessories.

You can now install and connect the appliance.

### Caution!

#### Risk of material damage/damage to the appliance

Objects remaining in the drum that are not designed for operation with the appliance may result in material damage and damage to the appliance. Remove these objects, along with all accessories, from the drum.

### Installing the appliance



#### Warning

#### Risk of injury!

- The appliance is very heavy. Lifting it may result in injury. Do not lift the appliance on your own.
- The appliance has sharp edges on which you could cut your hands. Do not take hold of the appliance by its sharp edges. Wear protective gloves to lift it.
- If the hoses and mains cables are not correctly routed, they may constitute a tripping hazard, which may result in injury. Route hoses and cables such that they do not constitute a tripping hazard.

## Installing the bottom plate

1. Lay the appliance down with its front panel resting on a piece of soft material.

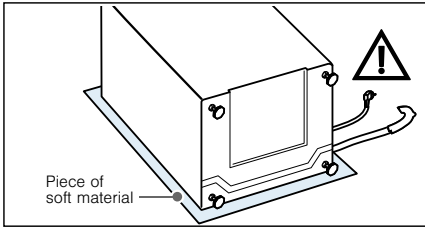

2. Push the bottom plate onto the underside of the appliance and screw it in place.

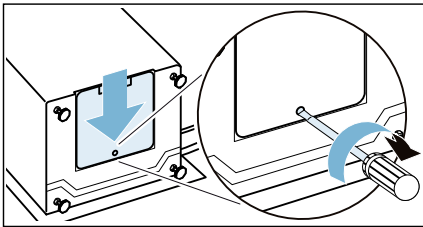

## Installation surface

### Caution!

#### Risk of damage to the appliance

Frozen hoses may rupture or burst. Do not install the appliance in areas that may be exposed to frost or outdoors.

**Note:** The appliance must be stable so that it does not "wander".

- The surface on which the appliance is installed must be firm and level.
- Soft floors/floor coverings are not suitable.
- All four of the appliance's feet must stand firmly on the ground.

## Hose and pipe lengths

- Connecting

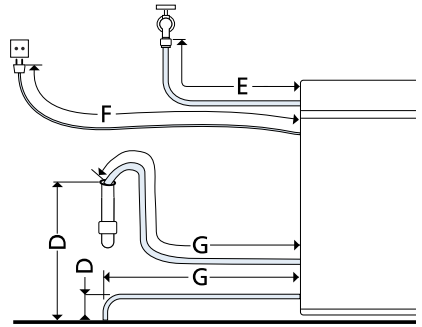

### Model with pump and a maximum load of 14 kg or more:

D	Min. 86 cm - max. 120 cm
E	140 cm
F	Max. 190 cm
G	150 cm

### Model with pump and a maximum load below 14 kg:

D	Min. 86 cm - max. 100 cm
E	140 cm
F	Max. 190 cm
G	150 cm

### Model without pump:

D	Max. 15 cm
E	140 cm
F	Max. 190 cm
G	Max. 100 cm

## Connecting the appliance

### Caution!

#### Risk of material damage/damage to the appliance

- If the water pressure is too high or too low, the appliance may not be able to operate properly, and this may also result in material damage or damage to the appliance. Ensure that the water pressure in the water supply facility is at least 30 kPa (0.3 bar), and does not exceed 800 kPa (8 bar).
- If the water hoses are altered or damaged, this may result in material damage or damage to the appliance. The water hoses must not be kinked, crushed, altered or severed.
- The use of hoses supplied by other brands to connect to the water supply may result in material damage or damage to the appliance. Use the hoses supplied with the appliance or genuine spare part hoses only.

### Notes

- In addition to the information listed here, the local water and electricity supplier may have special requirements.
- If in doubt, have your appliance connected by a professional.

## Water supply hose

### Notes

- When using a spanner, use the correct size and apply controlled force.
- Only operate the appliance using mains water.

## Connection to the universal tap adapter

**Note:** When connecting to a threadless tap, fit the supplied adapter first.

1. Slide the sliding sleeve downwards from the snap connector (all balls must be exposed) and then disconnect the snap connector from the connection socket.

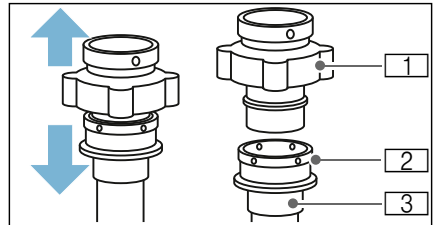

- 1 Connection socket
- 2 Exposed balls
- 3 Snap connector

2. Turn part B of the connection socket until the clearance between part A and part B is at least 5 mm.

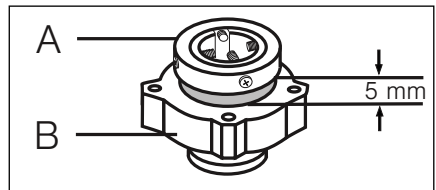

3. Unscrew all of the screws from part A.
4. Slide the connection socket over the tap opening and then screw the screws tightly back into part A.

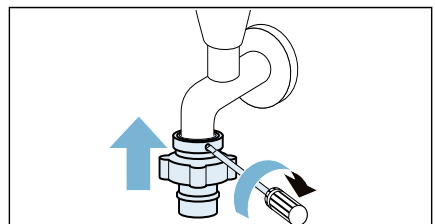

**Note:** Ensure the following:

- The tap's opening is smooth and even.
  - The seal is positioned centrally with respect to the tap opening.
5. Retighten part B.
  6. Slide the sliding sleeve downwards from the snap connector (all balls must be exposed), insert the snap connector into the connection socket and slide it upwards.

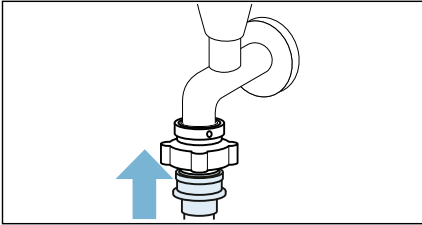

### Model with hot water supply:

1. Connect the red-marked hot water supply hose to the hot water tap ( $\frac{3}{4}$ "; max. 60 °C) and to the red valve on the appliance, and connect the blue-marked cold water supply hose to the cold water tap ( $\frac{3}{4}$ ") and to the blue valve on the appliance.

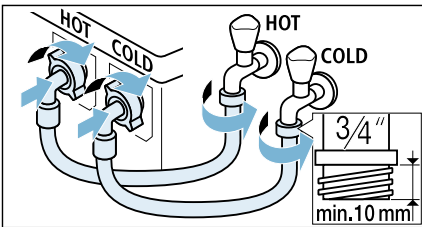

2. Carefully turn on the taps and check that there are no leaks.

### Notes

- The threaded connection is subject to high water pressures.
- Both hoses must be connected in order for the appliance to work correctly.

### Model without hot water supply:

1. Connect the water supply hose to the tap ( $\frac{3}{4}$ ") and to the valve on the appliance.

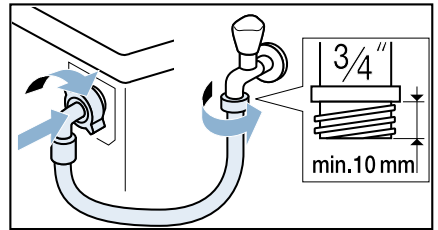

2. Carefully turn on the taps and check that there are no leaks.

**Note:** The threaded connection is subject to high water pressures.

### Water drainage

#### Caution! Water damage

When water is being pumped away, the drain hose is under high water pressure and may slip out of the wash basin or connection point.

Secure the drain hose so that it cannot slip out.

#### Caution! Damage to the appliance/laundry

If the end of the drain hose is immersed in the drained water, water may be sucked back into the appliance and may damage the appliance/laundry.

Make sure that:

- The wash basin outlet is not blocked,
- The end of the drain hose is not immersed in the drained water,
- The water drains away quickly enough.

**Connect the water drain hose as follows:**

1. Use the spring clip to secure the water drain hose to the outlet on the appliance.

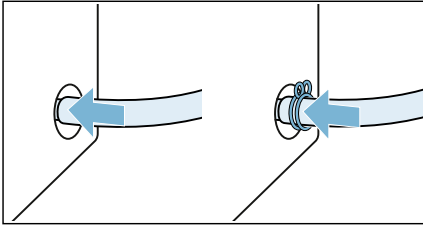

- Note:** Only for appliances with a separate water drain hose.
2. Second end of the water drain hose:
    - For models with a pump, attach it to a waste pipe or hang it in a wash basin.

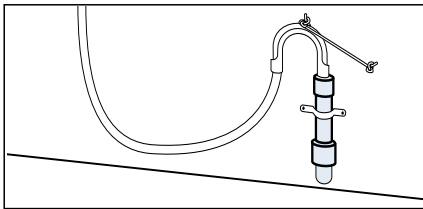

**Note:** The height difference between the surface on which the appliance is installed and the drain pipe must be between 86 and 100 cm or 120 cm, depending on the product variant. → Page 5

- For models without a pump, secure it in a floor drain.

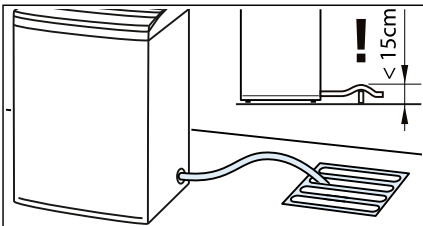

**Notes**

- The height difference between the surface on which the appliance is installed and the water drain hose should be no more than 15 cm.
- If you extend the drain hose, its total length should be no more than 3 m. Otherwise, the water will not be able to drain away properly.

**Electrical connection**

**⚠ Warning**  
**Risk of electric shock/fire/material damage/damage to the appliance!**

If the appliance is not installed properly, this may lead to a dangerous situation. Ensure the following:

- The mains voltage on your power socket must match the rated voltage specified on the appliance (identification plate). The connected loads and the required fuse protection are specified on the identification plate.
- The appliance must only be connected to alternating voltage via a protective contact socket that has been correctly installed. This plug socket must be freely accessible at all times.
- The mains plug and the protective contact socket must match and the earthing system must be correctly installed.
- The installation must have an adequate cross section.
- The mains plug must be freely accessible at all times. If this is not possible, in order to comply with the relevant safety regulations, a switch (all pole disconnection) must be built into the permanent installation in accordance with electrical installation regulations.



- If using a residual current circuit breaker, only use one that bears the following mark: . The presence of this mark is the only way to be sure that it fulfils all the applicable regulations.

### Connect the appliance to the mains power supply as follows:

1. Plug the appliance's mains plug into the designated socket.
2. Check that the mains plug is in securely.

## Levelling the appliance

### Level the appliance as follows:

Adjust the height of the appliance feet to level the appliance. Tighten the lock nuts on all the appliance's adjustable feet against the housing. As you do so, hold the foot tight and do not adjust its height. Use the spirit level on the control panel to check whether the appliance is level.

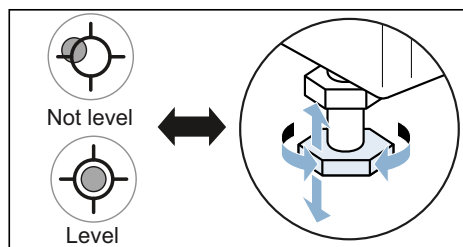

**Note:** If the appliance is ever moved, check that it is still level and re-level it if necessary.

## Before using the appliance for the first time

### Before you switch on the appliance:

Check that there is no visible damage to the appliance. Do not operate the appliance if it is damaged. Should you have any problems, please contact your specialist dealer or our after-sales service.

Your appliance has been thoroughly tested before leaving the factory. To remove any water that may be left over from testing, run the first wash cycle **without** any laundry.

### Run a program without laundry as follows:

1. Press  to switch on the appliance.
2. Set the **Tub clean/Tub Clean** program.
3. Open the appliance lid (but do not place any laundry inside).
4. Pull out the detergent drawer.

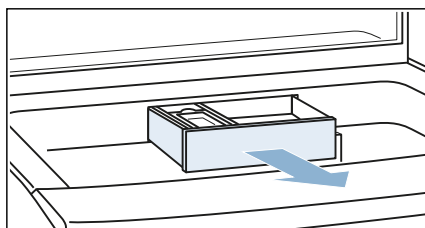

5. Fill compartment **I** with washing power, or fill compartment **II** with liquid detergent.

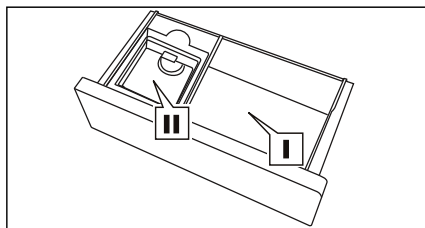







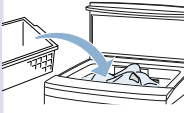
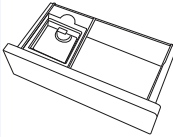
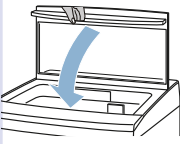

6. Close the detergent drawer.
7. Press .
8. Switch off the appliance at the end of the program.

Your appliance is now ready to use.

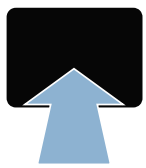
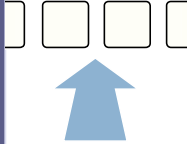

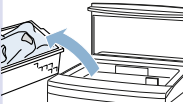
## Quick reference guide

1	<b>Before starting the program:</b>							
		Sort the laundry.	Turn on the water tap.	Load the laundry.				
		2						
Add detergent.	Close the appliance lid.						Switch on the appliance.	Set a program.
3								If necessary, adjust the programme settings.
		4	<b>Once the programme has ended:</b>			Open the lid and remove the laundry.		



## Familiarising yourself with your appliance

### Appliance overview

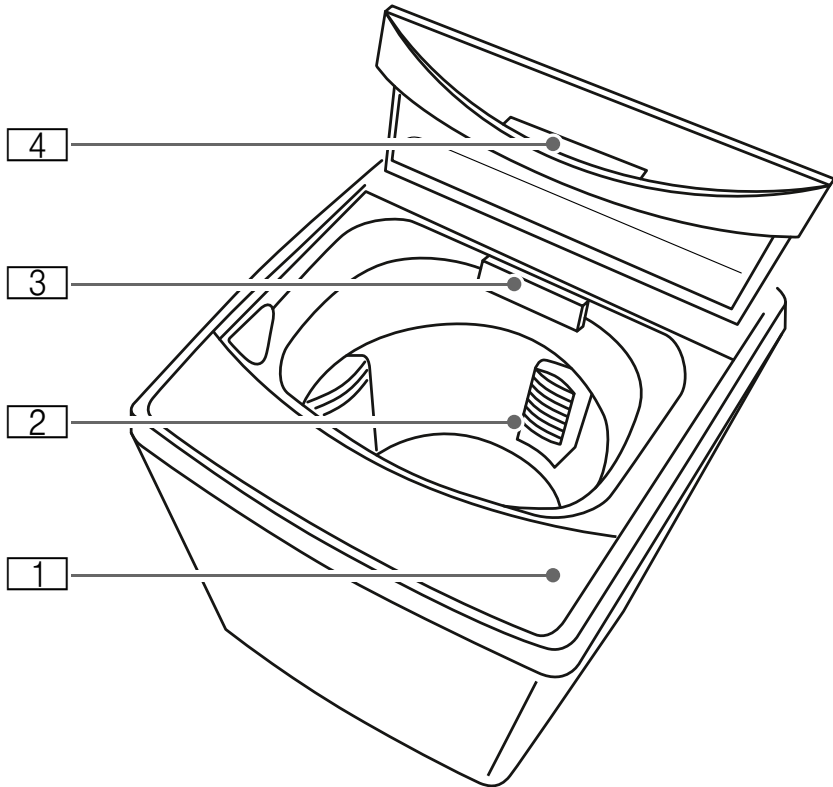

- 1** Control and display panel
- 2** Filter bag
- 3** Detergent drawer
- 4** Appliance lid

## Panel

Model **without** a hot water supply hose:

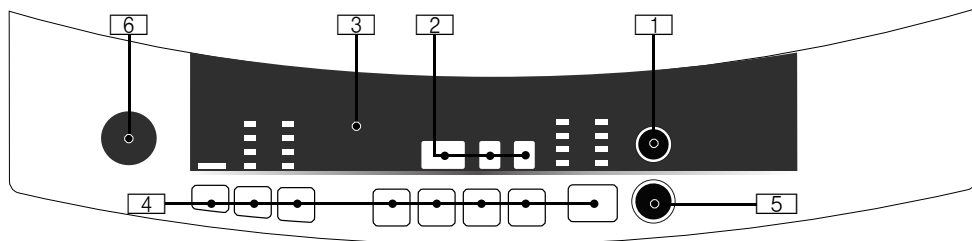

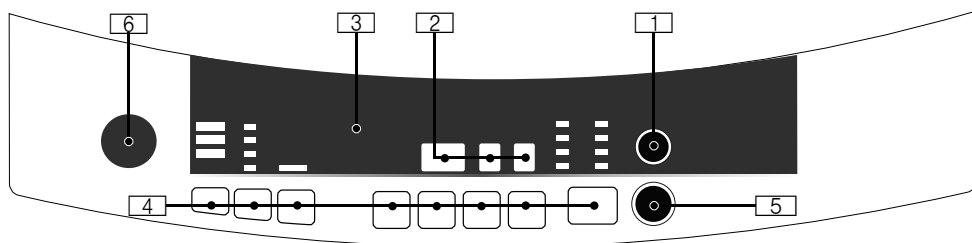

Model **with** a hot water supply hose:



- 1** **Main switch**  
Press this button to switch the appliance on or off.
- 2** **Display**  
Displays settings and information. → *Page 13*
- 3** **Display panel**  
Displays settings and information.
- 4** **Buttons**  
To set a program and adjust the program settings. → *Page 17*
- 5** **Start button**  
To start or interrupt a program or select the automatic program.
- 6** **Spirit level**  
Allows you to check whether the appliance is level. → *Page 9*

**Display**









Number/code	Description	Information
e.g. 50	Wash/spin cycle duration	Expected wash/spin cycle duration (  <b>wash/Wash</b> and  <b>Spin</b> ) in minutes.
e.g. 2	Rinse cycles	Number of rinse cycles (  <b>Rinse</b> ) in the set program.
e.g. 04	Program start delay	Delay to the program start in hours if you have activated the <b>Delay start/Delay Start</b> program setting.
E1	Water supply	The machine is not filling with water properly (unable to reach default water level). Make sure that: <ul style="list-style-type: none"> <li>■ The tap is fully open.</li> <li>■ The supply hose is not kinked or trapped.</li> <li>■ The filter in the water supply is not blocked. → <i>Page 29</i></li> </ul>
E2	Water outlet	The drain pump or drain hose/drain pipe is blocked: <ul style="list-style-type: none"> <li>■ Clean the drain pump → <i>Page 25</i></li> <li>■ Clean the drain hose/drain pipe</li> </ul>
E3	Open lid	The lid must be fully closed when a program is in progress. <ul style="list-style-type: none"> <li>■ Close the lid and press the Start button</li> <li>■ Remove any trapped laundry</li> </ul>
E4	Unbalanced load	<ul style="list-style-type: none"> <li>■ The laundry is not evenly distributed in the drum, creating an imbalance.</li> </ul> <p><b>Note:</b> The appliance has an unbalanced load detection system, which interrupts the spin cycle when the laundry is unevenly distributed. Redistribute the laundry by hand to eliminate the imbalance.</p> <ul style="list-style-type: none"> <li>■ Adjust the height of the appliance feet to level the appliance. → <i>Page 9</i></li> </ul>

CL	Note	<p>The lid has been opened while the <b>child lock/Child Lock/Child lock</b> was active.</p> <ol style="list-style-type: none"><li>1. Switch off the appliance.</li><li>2. Wait 5 seconds.</li><li>3. Switch the appliance on again.</li></ol>
F0-F8	Other faults	<ol style="list-style-type: none"><li>1. Switch off the appliance.</li><li>2. Wait 5 seconds.</li><li>3. Switch the appliance on again.</li></ol> <p>If the fault occurs repeatedly, call the after-sales service.</p>





## Programme overview

Program/type of laundry/information	Load size
<p><b>Name of program</b> Brief explanation of the program and the items for which it is suitable.</p>	Recommended load (in relation to the maximum load → <i>Page 31</i> )
<p><b>Cotton/Daily Wash</b> Hard-wearing items made of cotton, linen or blended fabrics</p>	Full load
<p><b>Delicates/Soft</b> For delicate washable items, e.g. made of satin, synthetic fibres or blended fabrics. <b>Note:</b> Use a detergent that is suitable for machine-washing delicate fabrics.</p>	1/2 load
<p><b>Soak/Dynamic Soak/Refresh</b> Before the main wash cycle starts, the laundry remains in the water for 30 min to remove heavy soiling. To be used for particularly stubborn soiling. <b>Note:</b> To avoid discolouration, only soak laundry of the same colour together.</p>	Full load
<p><b>Intensive</b> Hard-wearing items made of cotton, linen or blended fabrics. Program with a high water level and long wash, rinse and spin cycles. Suitable for heavily soiled laundry.</p>	Full load
<p><b>Quick/Quick Wash</b> Suitable for small items of lightly soiled laundry.</p>	1/3 load
<p><b>Memory</b> This allows you to save a selected program with your favourite settings:</p> <ol style="list-style-type: none"> <li>1. Switch on the appliance.</li> <li>2. Set the Memory program.</li> <li>3. Adjust the program settings if necessary or start the program.</li> </ol> <p><b>Note:</b> When you set the Memory program again the next time you wash laundry, the parameters you last set will still be active.</p>	-
<p><b>Air Dry</b> Program for drying hard-wearing fabrics and fabrics that do not repel water. The laundry is spun and air-dried at a reduced speed.</p>	Full load

<p><b>Tub clean/Tub Clean</b></p> <p>Program for cleaning and caring for the drum and the impeller, e.g. before running the first wash cycle or if an odour has developed after an extended period of non-use.</p> <p><b>Notes</b></p> <ul style="list-style-type: none"> <li>■ We recommend running this program once a month.</li> <li>■ Run the <b>Tub clean/Tub Clean</b> program without any laundry.</li> <li>■ Use standard washing powder or a detergent that contains a bleaching agent. To prevent foaming, only use half the amount of detergent recommended by the detergent manufacturer. Do not use detergents intended for woollens or delicates.</li> </ul>	<p>Empty</p>
<p><b>Auto Start/One Touch Start</b></p> <p>The washing program and water level are set automatically depending on the load.</p> <p><b>Note:</b> The washing program starts immediately and the program duration is shown on the display. Ensure the following beforehand:</p> <ul style="list-style-type: none"> <li>■ The laundry is placed into the drum.</li> <li>■ The detergent has been added.</li> </ul> <p><b>Setting Auto Start/One Touch Start:</b></p> <ol style="list-style-type: none"> <li>1. Press  to switch on the appliance.</li> <li>2. Press .</li> </ol> <p><b>Note:</b> If laundry is heavily soiled, chose a program suitable for the type of fabric.</p>	<p>-</p>
<p><b>Rinse</b></p> <p>Laundry is rinsed and then spun, and the rinsing water is pumped away.</p> <p><b>Setting the Rinse program:</b></p> <ol style="list-style-type: none"> <li>1. Press  to switch on the appliance.</li> <li>2. Press  <b>Rinse</b>.</li> <li>3. Press .</li> </ol>	<p>-</p>
<p><b>Spin</b></p> <p>Laundry is spun only, and the rinsing water is then pumped away.</p> <p><b>Setting the Spin program:</b></p> <ol style="list-style-type: none"> <li>1. Press  to switch on the appliance.</li> <li>2. Press  <b>Spin</b>.</li> <li>3. Press .</li> </ol>	<p>-</p>



## **P+** Buttons

Program setting	Function
	<p>Once you have set a program, you will be shown default program settings. These are recommendations for the set program and may vary. Depending on the program, you can adjust or activate/deactivate the program settings to optimise the washing process for your laundry.</p> <p>You can find out how to adjust program settings on → <i>Page 20</i></p>
 <b>wash/Wash</b>	Once the programme has been set, the wash cycle's preset duration will be displayed. You can adjust the duration of the wash cycle.
 <b>Rinse</b>	<p><b>Adjusting the number of rinse cycles:</b></p> <p>Once the program has been set, the preset number of rinse cycles will be displayed. You can adjust the number of rinse cycles.</p>
 <b>Spin</b>	<p><b>Adjusting the duration of the spin cycle:</b></p> <p>Once the program has been set, the spin cycle's default duration will be displayed. You can adjust the duration of the spin cycle.</p> <p><b>Rinse Hold:</b></p> <p>If you deselect the spin cycle, your laundry will remain in water after the final rinse cycle.</p> <p>For reducing creasing when the laundry is not taken out of the appliance immediately after the program ends.</p>
<b>Program</b>	When you switch on the appliance, the <b>Auto Start/One Touch Start</b> program is set by default. If required, you can change the program before the <b>program starts</b> .
<b>Water Level</b>	<p>Once the program has been set, the program's default water level will be displayed. You can adjust the water level if required.</p> <p><b>Notes</b></p> <ul style="list-style-type: none"> <li>■ If the water level is not shown on the display, the program you are using is one in which the appliance automatically adjusts the water level according to the size of the load. You can still manually adjust the water level when using these programs if you need to.</li> <li>■ Only set a low water level for light loads.</li> </ul>
<b>Temp.</b>	<p><b>cold/Cold:</b> Draw water from the cold water supply hose only.</p> <p><b>warm/Warm:</b> Draw water from the hot and cold water supply hoses.</p> <p><b>hot/Hot:</b> Draw water from the hot water supply hose only.</p> <p><b>Note:</b> Depending on the appliance specifications, water may be drawn from both hot and cold water supply hoses in the <b>hot/Hot</b> setting.</p>
<b>SpeedPerfect/ Speed Perfect</b>	<p>For a shorter wash time with a comparable washing result to the standard program setting. Please note that the energy consumption with this setting is higher than with standard program settings.</p> <p><b>Note:</b> Pressing the <b>Temp.</b>, <b>Water Level</b> or <b>Delay start/Delay Start</b> button resets the <b>SpeedPerfect/Speed Perfect</b> setting.</p>

<b>Delay start/Delay Start</b>	<p>You can use the <b>Delay start/Delay Start</b> button to delay the time at which the program starts by up to 24 hours.</p> <p>Your chosen time in hours, e.g. 8 h, is shown on the display and counts down until the program starts. Once the program has started, the program duration will be displayed.</p> <p><b>Note:</b> If you activate the <b>Delay start/Delay Start</b> program setting, the <b>Auto Start/One Touch Start</b> function will not be available.</p>
<b>Soil Level</b>	<p>You can specify how heavily soiled your laundry is. The appliance adjusts the intensity of the drum movement according to how heavily soiled the laundry is.</p>



## Laundry

### Preparing the laundry

#### Caution!

#### Risk of damage to the drum and laundry

Leaving objects in the pockets of your clothing can cause damage to the drum and laundry when the appliance is in operation. Remove all objects (e.g. metal items) from clothing pockets.

Prepare the laundry as follows:

- Empty all pockets.

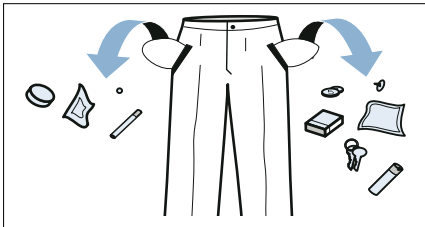





- Tie cloth belts, apron strings, etc. together. For small items of laundry, such as socks and stockings, use a laundry bag.
- Always wash small and large items of laundry together.
- Close any zips, Velcro, hooks, loops or buttons.
- Brush sand out of pockets and collars.
- Remove curtain fittings or place curtains in a laundry bag.
- Pre-treat stains while they are fresh. First, dab stains with soapy water without rubbing them.

**Note:** Stubborn or dried-in stains can sometimes only be removed by washing several times.

### Sorting laundry

Sort your laundry according to the care instructions and the manufacturer's information on the care labels, using the following criteria:

- **Type of fabric/fibre**
- **Colour:**  
Laundry may become discoloured. Wash white and coloured laundry separately. Wash new coloured items on their own the first time you wash them.
- **Soiling:**  
Wash laundry with the same level of soiling together.
- **Care labels:**  
The following symbols tell you which programs you can and cannot use. The numbers in the symbols indicate the maximum recommended washing temperature.

-  Suitable for a normal washing process, e.g. the Cotton/Daily Wash program.
-  A gentle washing process is required, e.g. the Delicates/Soft program.
-  A particularly gentle washing process is required, e.g. the Delicates/Soft program.
-  Do not machine wash.



## Operating the appliance

### Switching on the appliance and setting a programme

**Note:** The appliance must be correctly installed and connected. → *Page 4*

1. Press  to switch on the appliance.

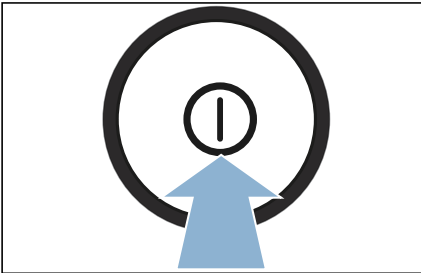

2. Press **Program** repeatedly to set the washing program you require.

**Note:** To set the **Rinse, Spin** and **Auto Start/One Touch Start** programs, follow the instructions in the program overview. → *Page 15*

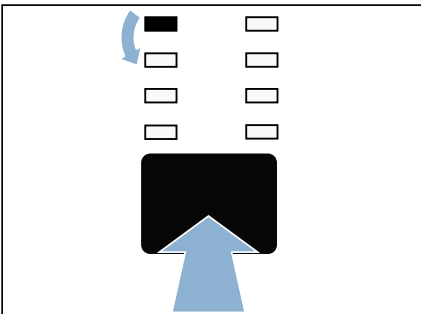

The corresponding indicator light will light up and the default program settings will be shown on the display panel.

3. Adjust the **programme settings** if required.

## Programme settings

Once you have set a program, you will be shown default program settings. Before the program starts, you can adjust or activate/deactivate the settings that can be selected. An overview of all the settings that can be selected can be found from → *Page 17* onwards.

### You can do the following to program settings:

- Activate/deactivate them
- Adjust them

### Adjusting or activating/deactivating:

Press the button for the relevant programme setting repeatedly.

The indicator lights for the activated programme settings will be continuously lit/will flash and the values shown on the display may change.

## Placing the laundry into the drum

**Note:** Do not exceed the appliance's maximum load. If you overload the appliance, it will not be able to wash the laundry as effectively and the laundry is more likely to crease. → *Page 31*

1. Prepare and sort the laundry.
2. Open the lid.  
Check that the drum is completely empty. Empty it if necessary.

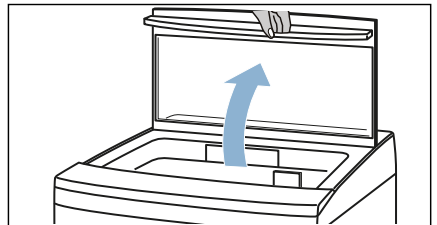

3. Load the laundry unfolded into the drum.

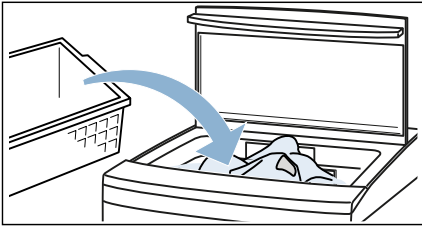

4. Close the lid.

**Caution!**

**Risk of material damage to the appliance or laundry.**

Make sure that laundry is not trapped in the lid.

## Adding detergent and fabric care products

**Caution!**

**Risk of material damage and damage to the appliance**

If you use the wrong quantity of detergent or cleaning product, this may cause material damage or damage to the appliance.

Use detergents/care products/cleaning products in accordance with the manufacturers' instructions.

**Caution!**

**Risk of material damage and damage to the appliance**

Cleaning products and products for pre-treating laundry (e.g. stain removers, prewash sprays, etc.) may cause damage if they come into contact with the surfaces of the appliance. Therefore please note:

- Do not allow these products to come into contact with the surfaces of the appliance.

- Clean the appliance with nothing but water and a soft, damp cloth.
- Remove all detergent residue, spray residue or other residues immediately.

1. Pull out the detergent drawer.

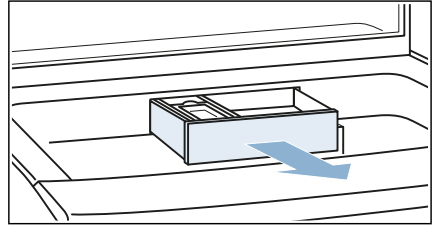

2. Add detergent and/or laundry care products.

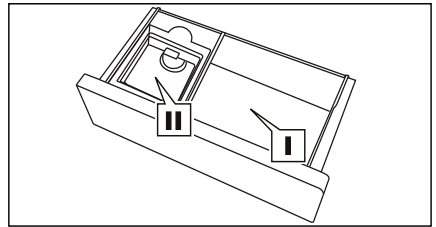

- I Compartment for washing powder, water softener, bleaching agent and stain remover
- II Compartment for liquid detergent.

3. Push in the detergent drawer.

**Notes**

- Do not mix different detergents.
- Follow the detergent dosage instructions on the label on the detergent packaging.

## Starting a programme

Press .

Either the programme duration or, if you have delayed the programme start, the **Delay start/Delay Starttime**, is shown in the display.

**Note:** If you want to prevent the programme from being adjusted inadvertently, you can activate the childproof lock.

## Childproof lock

Once the program has started, you can lock the appliance to prevent the functions you have set from being changed inadvertently. To do this, activate the childproof lock.

### Activating/deactivating the child lock/Child Lock/Child lock:



Press and hold the  **wash/Wash//Program** and  **Rinse** buttons at the same time for approximately 3 seconds.

The **child lock/Child Lock/Child lock** indicator light changes depending on the previous status.

### Notes

- If you open the lid while the childproof lock is activated, a signal will sound and the error code E3 will be displayed. If the lid is not closed and the  button pressed within 20 seconds, the appliance will automatically pump water away and display the error code CL until you switch off the appliance.
- When the childproof lock is active, the appliance can be switched off via the main switch. The childproof lock will be deactivated when the appliance is switched off.

## Pausing programmes and adding more laundry



1. Press .  
The appliance will pause the program.
2. If you need to, you can add more laundry or remove laundry.
3. Press  to resume the program.

### Notes

- If you pause the appliance for more than 1 hour, it will automatically switch off.
- When the wash and spin cycles are in progress, make sure that you pause the appliance before opening the lid.

## Cancelling the programme



Once the program has started, you can cancel it at any time:

1. Press  to switch off the appliance.
2. Press  to switch the appliance back on.
3. Open the lid and remove the laundry or start a new program.

### Notes

- When you start a new program, the appliance will first check the current water level and, if necessary, pump some of the water away.
- If the water level is high or there is a high level of residual moisture in the laundry, run the **Spin** program before taking out your laundry.

## Resuming the programme when the programme status is Rinse Stop

1. Press  to switch on the appliance.
2. Press  **Spin** to set the **Spin** program and to adjust the duration of the spin cycle.
3. Press .

## Programme end

At the end of the program, a signal will sound and then the appliance will switch off automatically.

## Removing laundry and switching off the appliance

1. Remove the laundry.

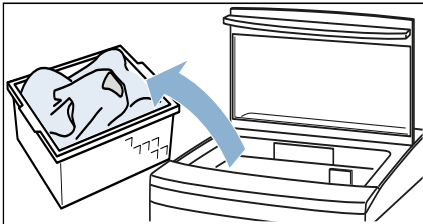

2. Turn off the tap.

### Notes

- **Risk of rusting:** Remove any foreign objects from the drum.
- Leave the lid and detergent drawer open so that residual water can evaporate.

## Sensors

### Unbalanced load detection system

The automatic unbalanced load detection system detects imbalances and ensures that laundry is distributed evenly by repeatedly starting to spin the drum and activating additional rinse cycles.

**Note:** Mix items of laundry of varying sizes. Laundry items of different sizes distribute themselves better during the spin cycle. Individual laundry items may cause an unbalanced load.

### Continuous automatic load adjustment function

The continuous automatic load adjustment function adjusts the water level according to the load in the drum.



## Cleaning and maintenance

### Cleaning/Maintenance

#### **Warning**

##### **Risk of death!**

The appliance is powered by electricity. There is a risk of electric shock if you come into contact with live components. Therefore please note:

- Switch off the appliance. Disconnect the appliance from the power supply (pull out the plug).
- Never take hold of the mains plug with wet hands.
- When removing the mains plug from the socket, always take hold of the plug itself and never the mains cable, otherwise this may damage the mains cable.
- Do not make any technical modifications to the appliance or its features.
- Repairs and any other work on the appliance must only be conducted by our customer service or by an electrician. The same applies for replacing the mains cable (when necessary).
- Spare mains cables can be ordered from our customer service.

#### **Warning**

##### **Risk of poisoning!**

Poisonous fumes may be given off by cleaning agents that contain solvents, e.g. cleaning solvent. Do not use cleaning agents that contain solvents.

#### **Warning**

##### **Risk of electric shock/material damage/damage to the appliance!**

If moisture penetrates the appliance, this may cause it to short circuit. Do not use a pressure washer, steam cleaner, hose or spray gun to clean your appliance.

#### **Warning**

##### **Risk of injury/material damage/damage to the appliance!**

The use of spare parts and accessories supplied by other brands is dangerous and may result in injury, material damage or damage to the appliance. For safety reasons, use genuine spare parts and accessories only.

#### **Caution!**

##### **Material damage/damage to the appliance**

Cleaning agents and agents for pretreating laundry (e.g. stain removers, prewash sprays, etc.) may cause damage if they come into contact with the surfaces of the appliance. Therefore please note:

- Do not allow these agents to come into contact with the surfaces of the appliance.
- Clean the appliance with nothing but water and a soft, damp cloth.
- Remove any detergent, spray or other residues immediately.



## Cleaning the drum

To prevent odours from developing and to clean the drum:

- Run the **Tub clean/Tub Clean** program, adding standard washing powder but not any laundry.  
**Note:** Do not use steel wool or cleaning products containing chlorine.
- Make sure that the area in which the appliance is installed is well ventilated.

## Descaling the appliance

Descaling should not be necessary if the detergent is measured out correctly. If you still wish to use descaler, follow the manufacturer's instructions for use.

### Caution!

#### Risk of material damage/damage to the appliance

Unsuitable descaling agents, e.g. dishwasher tablets or coffee machine descalers, can cause material damage and damage to the appliance. Do not use unsuitable descaling agents for this appliance. You can order suitable descaling agents from our website or from our after-sales service.

## Cleaning the drain pump

**Note:** Only for appliances with a drain pump and a maximum load of less than 14 kg.

1. Turn the pump cover on the back of the appliance anti-clockwise to remove it, and drain the washing water into a suitable container.

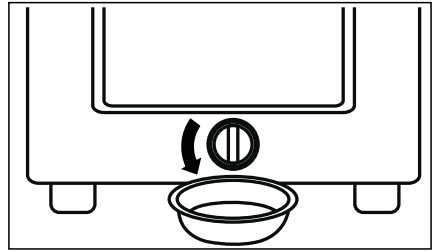

2. Clean the inside and the thread on the pump cover and pump housing.  
**Note:** The impeller in the drain pump must be able to rotate.

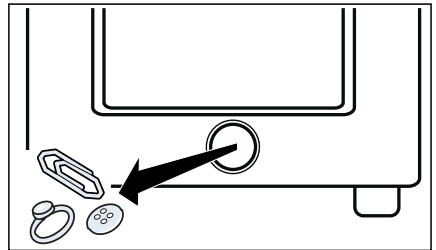

3. Put the pump cover back in place and screw it back on fully.

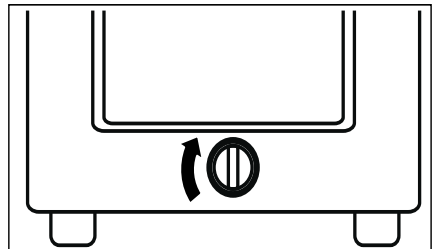

You have now successfully cleaned the drain pump.

## Cleaning the lint filter

During the wash cycle, washing powder residue and lint accumulate in the drum's filters. Clean these filters after every wash, as follows:

1. Remove the filter from the holder.

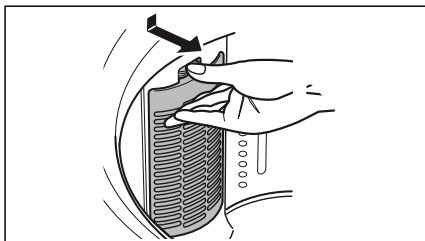

2. Remove the net bag,\* clean it and put it back in.

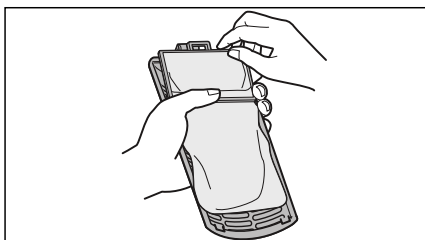

3. Place the filter back into the holder.

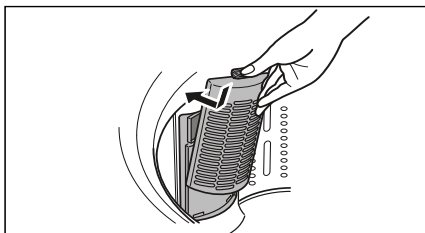

You have now successfully cleaned the filter.

\* Depending on the appliance specifications





## What to do in the event of a fault

### **Warning**

#### **Risk of injury!**

If you reach into the drum while it is still rotating, you risk injuring your hands. Wait until the drum has stopped rotating.

## Help with the appliance

Faults	Cause/remedy
The appliance will not start.	Check the mains plug and the fuses.
The appliance is not filling with water.	<p>Check that:</p> <ul style="list-style-type: none"> <li>■ You have pressed .</li> <li>■ The tap has been turned on and the water pressure is not too low.</li> <li>■ The filter in the water supply is not blocked. → <i>Page 29</i></li> <li>■ The supply hose is not kinked or trapped.</li> </ul>
The washing water is not draining.	<p>Make sure that:</p> <ul style="list-style-type: none"> <li>■ The drain pump has been cleaned. → <i>Page 25</i></li> <li>■ The drain pipe and the drain hose are clean.</li> <li>■ <b>Rinse Hold</b> is not set.</li> <li>■ The maximum height difference between the surface on which the appliance is installed and the water drain hose has not been exceeded. → <i>Page 5</i></li> </ul>
The program will not start.	<p>Make sure that:</p> <ul style="list-style-type: none"> <li>■ The lid is closed.</li> <li>■ You have pressed .</li> </ul> <p><b>Note:</b> If the program start has been delayed by setting <b>Delay start/ Delay Start</b>, the program will start later.</p>
Water is leaking from the machine.	<ul style="list-style-type: none"> <li>■ Make sure that the drain hose is properly secured and is not damaged.</li> <li>■ Check the threaded joint on the supply hose, and tighten it if necessary.</li> </ul>
More detergent than usual is accumulating in the filter bag and drum.	You have been using too much detergent. Make sure you follow the detergent manufacturer's instructions.
There is detergent residue on the laundry.	<ul style="list-style-type: none"> <li>■ Some phosphate-free detergents contain water-insoluble residue.</li> <li>■ Start the <b>Rinse</b> program.</li> </ul>
The machine spins the drum back and forth several times.	<p>Not a fault – the unbalanced load detection system is adjusting an imbalance.</p> <p><b>Note:</b> If the error E4 appears on the display, redistribute the laundry by hand to eliminate the imbalance.</p>

Loud noises, vibrations or machine movement during the spin cycle.

Make sure that the appliance is completely level. → *Page 9*

Odours in the washing machine.

Run the **Tub clean/Tub Clean** program.

Add standard washing powder or a detergent that contains a bleaching agent.



**Note:** To prevent foaming, only use half of the amount of detergent recommended by the detergent manufacturer. Do not use detergents intended for woollens or delicates.

If you cannot rectify a fault yourself (after switching the appliance off and then on again) or a repair is required:

- Switch off the appliance and pull the mains plug out of the socket.
- Turn off the tap and call the after-sales service.

## Filter in water supply blocked

### Preparation:

1. Turn off the tap.
2. Set any programme (except Rinse/Spin).
3. Press . Allow the programme to run for approximately 40 seconds.
4. Press  to switch off the appliance.

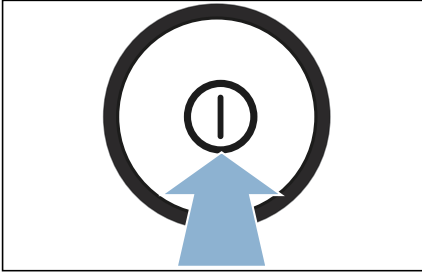

5. Disconnect the appliance's mains plug from the power supply.

### Clean the filter on the tap as follows:

1. Disconnect the hose from the water tap.

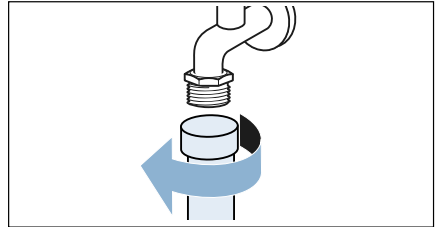

2. Clean the filter with a small brush.

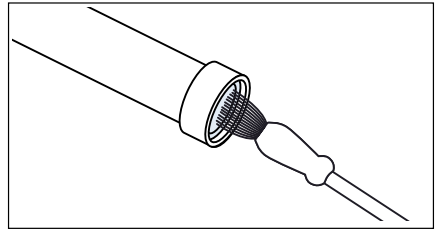

3. Connect the hose and check for leaks.

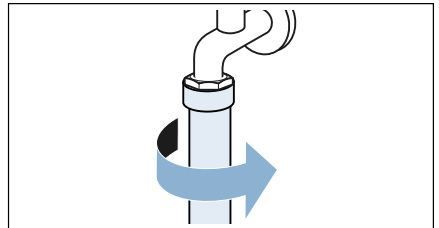

**Clean the filter on the back of the appliance:**

1. Remove the hose from the rear of the appliance.

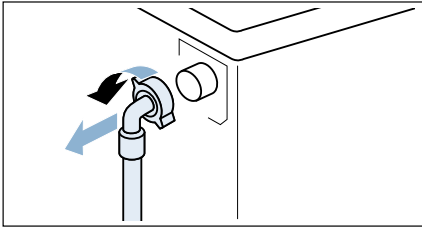

2. Clean the filter with a small brush.

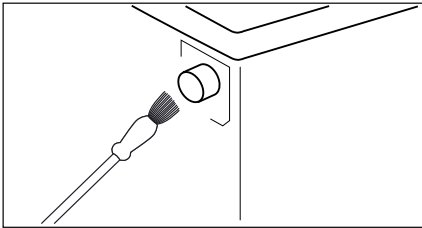

3. Reconnect the hose at the rear of the appliance and check for leaks.

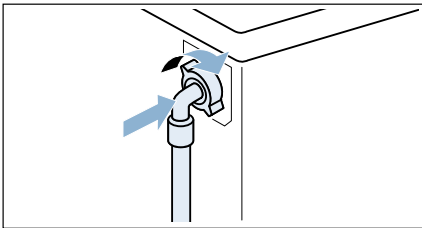

## Transporting the appliance

**Prepare the appliance for transportation as follows:**

1. Turn off the tap.
2. Press  to switch on the appliance.

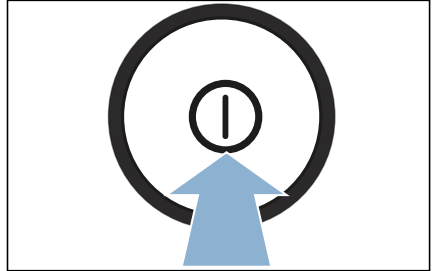

3. Run the **Spin** program without any residual water or laundry.  
→ Page 15  
**Note:** For models without a pump, place the drain hose on the floor and drain the water.
4. Disconnect the appliance's mains plug from the power supply.
5. For models with a drain pump, drain the remaining washing water.  
→ Page 25

**Note:** For models with a drain pump and a maximum load of more than 13 kg, place the drain hose on the floor and drain the water.

6. Remove the hoses.

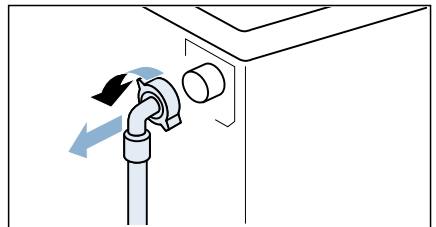

**Note:** Always transport the appliance upright.



## Technical specifications

**Note:** Check the voltage, frequency and maximum load on your appliance's rating plate.

### Models:

Dimensions (in mm)	Weight (in kg)	Rated voltage (in V)	Rated power (in W)	Rated frequency (in Hz)	Maximum load (in kg)
580 x 596 x 968	40	120 / 240	390 - 500	50 / 60	10
601 x 630 x 975	43	120 / 240	550 - 600	50 / 60	13
640 x 684 x 1020	54	120 / 240	600	50 / 60	15
686 x 715 x 1020	59	120 / 240	680	50 / 60	16

### Water pressure (for all models):

0.3 - 8 bar



## After-sales service

If you cannot rectify the error yourself by turning the appliance off and on again, please contact our after-sales service. → Enclosed after-sales service directory

We will always find an appropriate solution and, where possible, prevent the need for an engineer to visit.

Please provide the after-sales service with the product number (E no.) and the production number (FD) of the appliance.

E-Nr. \_\_\_\_\_ FD \_\_\_\_\_

E no.      Product number  
FD        Production number

You can find this information:

On the inside of the lid and on the back of the appliance.

### **You can trust in the manufacturer's expertise.**

Contact us for assistance. This will ensure that the repair is carried out by trained service engineers with genuine spare parts.









Contact information for all countries can be found in the enclosed after-sales service directory.

Robert Bosch Hausgeräte GmbH  
Carl-Wery-Straße 34  
81739 München, GERMANY



9001345015 (9709)