

VG 425 211 CA

Gas hob
瓦斯爐台

Table of contents	3
目錄	15

Table of contents

Intended use	4
Important safety information	5
Causes of damage	7
Environmental protection	7
Saving energy	7
Environmentally-friendly disposal	7
Familiarising yourself with your appliance	8
Gas hob	8
Control knob	8
Visual signals of the luminous disc	8
Individual parts of the burners	9
Operating the appliance	9
Switching on	9
Simmer setting	10
Electronic flame monitoring and automatic re-ignition	10
Switching off	10
Residual heat indicator	10
Safety shut-off	10
Table of settings and tips	10
Tips for cooking and roasting	10
Information and tips regarding cookware	11
Suitable cooking vessels	11
Precautions for use	11
Cleaning and maintenance	12
Cleaning the appliance	12
Burnt-on dirt	12
Burner discolouration	12
Trouble shooting	13
Demo mode	14
After-sales service	14
E number and FD number	14

Additional information on products, accessories, replacement parts and services can be found at www.gaggenau.com and in the online shop www.gaggenau.com/zz/store

Intended use

Read these instructions carefully. Only then will you be able to operate your appliance safely and correctly. Retain the instruction manual and installation instructions for future use or for subsequent owners.

This appliance is only intended to be fully fitted in a kitchen. Observe the special installation instructions.

This appliance must be installed according to the installation instructions included.

Check the appliance for damage after unpacking it. Do not connect the appliance if it has been damaged in transport.

Only allow a licensed professional to connect the appliance. Damage caused by incorrect connection is not covered under warranty. Call the after-sales service if you want to convert your appliance to a different type of gas.

This appliance is intended for domestic use and the household environment only. This appliance must only be used to prepare food and drinks and must never be used as a heater. Do not leave the appliance unattended during operation. Only use the appliance indoors.

Do not install this appliance on boats or in vehicles.

This appliance is intended for use up to a maximum height of 2000 metres above sea level.

This appliance is not intended for operation with an external clock timer or a remote control.

Do not use covers. These can cause accidents, for example due to overheating, catching fire or materials shattering.

Only use safety devices or child protection grilles approved by ourselves. Unsuitable safety devices or child protection grilles may result in accidents.

This appliance may be used by children over the age of 8 years old and by persons with reduced physical, sensory or mental capabilities or by persons with a lack of experience or knowledge if they are supervised or are instructed by a person responsible for their safety how to use the appliance safely and have understood the associated hazards.

Children must not play with, on, or around the appliance. Children must not clean the appliance or carry out general maintenance unless they are at least 15 years old and are being supervised.

Keep children below the age of 8 years old at a safe distance from the appliance and power cable.

Close the safety valve on the gas supply line if the cooker will not be used for a prolonged period.

⚠ Important safety information

⚠ Warning – WHAT TO DO IF YOU SMELL GAS!

Escaping gas may cause an explosion.

If you smell gas or notice any faults in the gas installation:

- Immediately shut off the gas supply or close the gas cylinder valve.
- Immediately extinguish all naked flames and cigarettes.
- Do not use any light or appliance switches and do not pull any plugs out of sockets. Do not use any telephones or mobile phones within the building.
- Open windows and ventilate the room.
- Call the after-sales service or the gas supplier.

⚠ Warning – Risk of asphyxiation!

The use of a gas cooker leads to a build-up of heat, moisture and products of combustion in the room where the appliance is installed. Ensure that the installation room is well ventilated. The natural ventilation openings must be kept open or a mechanical ventilation device must be provided (e.g. an extractor hood). Intensive and persistent use of the appliance may mean that it is necessary to have additional ventilation (e.g. opening a window), or more effective ventilation (e.g. operating the existing mechanical ventilation device at a higher setting).

⚠ Warning – Risk of fire!

- Hot oil and fat can ignite very quickly. Never leave hot fat or oil unattended. Never use water to put out burning oil or fat. Switch off the hotplate. Extinguish flames carefully using a lid, fire blanket or something similar.
- The hotplates become very hot. Never place combustible items on the hob. Never place objects on the hob.

- The appliance becomes very hot and flammable materials could catch fire. Never store or use flammable objects (e.g. spray cans, cleaning agents) under the appliance or in its immediate vicinity. Never place flammable items on or in the appliance.
- When gas hotplates are in operation without any cookware placed on them, they can build up a lot of heat. The appliance and the extractor hood above it may become damaged or be set on fire. Grease residue in the filter of the extractor hood may ignite. Only operate the gas burners with cookware on them.
- If the burner does not ignite after 15 seconds, switch off the control knob and open the door or window in the room. Wait at least 1 minute before igniting the burner again.

⚠ Warning – Risk of burns!

- The appliance becomes hot during operation. Allow the appliance to cool down before cleaning.
- The hotplates and surrounding area (particularly the hob surround, if fitted) become very hot. Never touch the hot surfaces. Keep children at a safe distance.
- The accessible parts become very hot when in operation. Never touch hot parts. Keep children at a safe distance.
- When the appliance cover is closed, heat will accumulate. Only close the appliance cover when the appliance has cooled down. Never switch the appliance on with the appliance cover closed. Do not rest food on the appliance cover or use it to keep food warm.

- Empty cookware becomes extremely hot when set on a gas hotplate that is in operation. Never heat up empty cookware.
- If the liquefied gas bottle is not upright, liquefied propane/butane can enter the appliance. Intense darting flames may therefore escape from the burners. Components may become damaged and start to leak over time so that gas escapes uncontrollably. Both can cause burns. Always use liquefied gas bottles in an upright position.

⚠ Warning – Risk of injury!

- Incorrect repairs are dangerous. Repairs may only be carried out, and damaged power and gas lines replaced, by an after-sales engineer trained by us. If the appliance is faulty, unplug the mains plug or switch off the fuse in the fuse box. Shut off the gas supply. Contact the after-sales service.
- Faults or damage to the appliance are dangerous. Never switch on a faulty appliance. Unplug the appliance from the mains or switch off the circuit breaker in the fuse box. Shut off the gas supply. Contact the after-sales service.
- Unsuitable pan sizes, damaged or incorrectly positioned pans can cause serious injury. Observe the instructions which accompany the cookware.

⚠ Warning – Risk of electric shock and serious injury!

- The cable insulation on electrical appliances may melt when touching hot parts of the appliance. Never bring electrical appliance cables into contact with hot parts of the appliance.
- Do not use any high-pressure cleaners or steam cleaners, which can result in an electric shock.
- A defective appliance may cause electric shock. Never switch on a defective appliance. Unplug the appliance from the mains or switch off the circuit breaker in the fuse box. Contact the after-sales service.
- Incorrect repairs are dangerous. Repairs may only be carried out by one of our trained after-sales engineers. If the appliance is faulty, unplug the mains plug or switch off the fuse in the fuse box. Contact the after-sales service.

Causes of damage

Caution!

- **Risk of heat damage to adjacent appliances or kitchen units:** If the appliance is in operation for an extended period, heat and moisture will be generated. Additional ventilation is required. Open the window or switch on an extractor hood that discharges the extracted air and moisture outside the building.
- **Risk of damage to the appliance due to the build-up of heat:** Do not heat roasters, frying pans or grill stones using more than one burner at a time.
- **Malfunction:** Always turn the control knob to the "Off" position when the appliance is not being used.

Environmental protection

The sections below list a number of energy-saving tips and provide information on disposing of your appliance.

Saving energy

- Choose a burner of roughly the same size as your pan. Place the cookware in the middle.
- Use small saucepans for small quantities. Using a large saucepan with little in it consumes a lot of energy.
- Always place suitable lids on saucepans. Cooking without a lid consumes significantly more energy. Use a glass lid so that you can see into the pan without having to lift the lid.
- Cook with only a little water. This will save energy and preserve the vitamins and minerals in vegetables.
- Switch to a lower heat setting in good time. This will save energy.

Environmentally-friendly disposal

Dispose of packaging in an environmentally-friendly manner.



This appliance is labelled in accordance with European Directive 2012/19/EU concerning used electrical and electronic appliances (waste electrical and electronic equipment - WEEE). The guideline determines the framework for the return and recycling of used appliances as applicable throughout the EU.

Familiarising yourself with your appliance

Gas hob

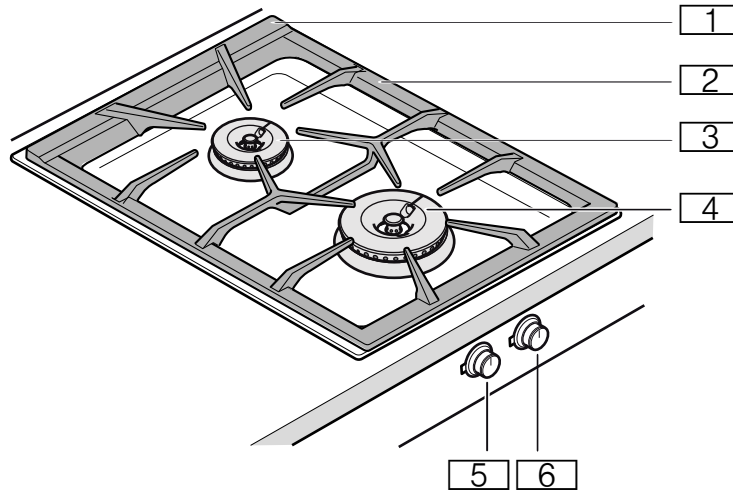

- 1 Ventilation openings (underneath pan support)
- 2 Pan support
- 3 Standard output burner NG1 2.0 kW /LPG 1.8 kW
- 4 High output burner NG1 3.5 kW /LPG 3.7 kW
- 5 Control knob, front hotplate
- 6 Control knob, rear hotplate

Control knob

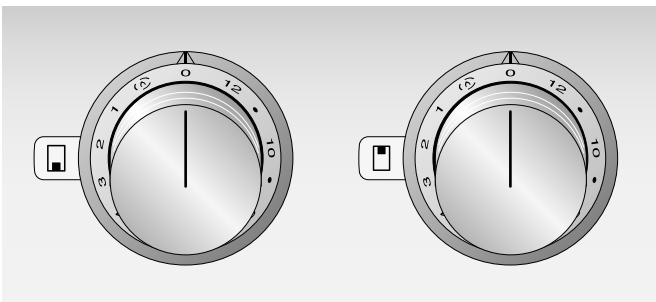

The markings show the position of the corresponding burner and the setting between level 1 to 12 or simmering (D).

Visual signals of the luminous disc

The control knob is encircled by an illuminated ring that indicates a number of statuses and functions.

Indicator	Meaning
○ Off	Appliance off
● Lit continuously orange	Appliance on
☀ Flashing orange	Appliance off Residual heat indicator
☀ Flashing orange and white alternately	Safety shut-off, power failure
☀ Flashing yellow and magenta alternately	Appliance fault Call the after-sales service.
● Lit green and then yellow for some seconds	Appliance initialising, only after first installation or power failure

Simmer setting

With the simmer setting, the burner switches the gas flame on and off. This allows you to melt chocolate or heat up delicate sauces, for example.

Turn the control knob to (🔥). It takes 10 - 50 seconds to switch on or off.

Electronic flame monitoring and automatic re-ignition

For your safety, the hob has an electronic flame monitoring system. If the flame goes out while the hob is in use (e.g. due to a draught), the appliance will automatically re-ignite the burner.

If re-ignition is unsuccessful (e.g. because liquid or food has boiled over and remains on the burner), the appliance will switch off the gas supply. The illuminated ring behind the control knob will flash.

Turn the control knob to 0. Wait until the appliance is cool enough and then check whether all the burner parts are in the correct position. Check whether the burner or the ignition plug are covered in food remnants etc. → "Trouble shooting" on page 13

Switching off

Turn the control knob to position 0. The appliance electronics will shut off the gas supply.

⚠ Warning – Risk of burns!

When the appliance cover is closed, heat will accumulate. Only close the appliance cover when the appliance has cooled down. Never switch the appliance on with the appliance cover closed. Do not rest food on the appliance cover or use it to keep food warm.

Residual heat indicator

The luminous disc behind the control knob flashes after switching off, to indicate that the appliance has still not cooled down to such an extent that it can be touched safely.

Safety shut-off

For your safety, the appliance has a safety shut-off function. The appliance is automatically switched off if it has been in operation for an extended period. How long the appliance waits before switching itself off depends on the setting (setting 12 = 1 hour, setting 1 = 4 hours). The illuminated ring behind the control knob will flash orange and white alternately.

Turn the control knob to 0. You will now be able to start the appliance again as usual.

Table of settings and tips

Heat setting	Cooking method	Examples
12	Heating	Water, clear soups
	Blanching	Vegetables
10-12	Searing	Meat, wok dishes/ pan-fried dishes
	Frying at high temperatures	Meat, potatoes
7-10	Simmering with the lid open	Liquids, dough-based foods
6-8	Baking	Flour-based food
	Frying at medium temperatures	Poultry, fish
4-6	Frying at low temperatures	Fried sausages, onions, egg dishes
	Warming	Vegetables, soups, stews
	Deep-frying	Chips, pastries
3-4	Poaching with the lid open	Dumplings, boiled sausages
	Defrosting	Frozen food
	Braising	Beef olives, joints
2-4	Stewing	Vegetables
	Simmering with the lid on	Soups, vegetables
Simmer setting – up to 3	Soaking	Rice, rice pudding, cereals
Simmer setting	Melting, keeping warm	Chocolate, butter

Tips for cooking and roasting

The values given in the settings table must be looked upon as recommended values. The heat required depends not only on the type and condition of the food, but also the size and contents of the pot.

Due to the high performance of the cooktop, fat and oil will heat up quickly. Never leave the cooktop unattended, fat can ignite, food can burn.

Preferably use the rear cooking zones to prepare meals, that need longer to cook.

Preferably use the high output burners for brief cooking, deep fat frying and searing of large quantities.

Information and tips regarding cookware

The following information and tips have been provided to help you save energy and avoid damaging your cookware.

Suitable cooking vessels

Burner	Recommended pan base diameter	Minimum pan base diameter
Standard-output burner	200 - 240 mm	90 mm
High-output burner	240 - 280 mm	90 mm

Pans with a diameter of less than 90 mm or more than 280 mm should not be used. If you do use larger pans, these should not protrude beyond the edges of the appliance.

Precautions for use

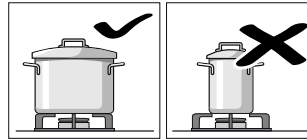

Use pots or pans which are the right size for each burner.

Do not use small pots or pans on large burners. The flame should not touch the sides of the pot.

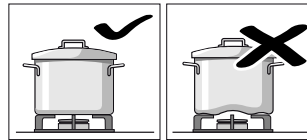

Do not use damaged pots or pans, which do not sit evenly on the cooktop, they may tip over.

Only use pots or pans with a thick, flat base.

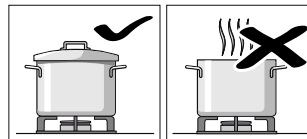

Do not cook without using a lid and make sure the lid is properly fitted. This wastes energy.

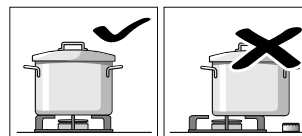

Always centre the pot or pan over the burner, otherwise it could tip over.

Do not place large pots on the burners near the control knobs. These may get damaged by the high temperatures.

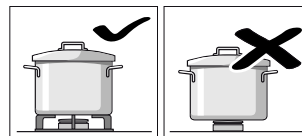

Place the pots or pans on the pan support, never directly on the burner.

Make sure that the pan supports and burner caps are correctly positioned before using the appliance.

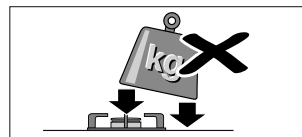

Pots or pans should be placed on the cooktop carefully.

Do not strike the cooktop and do not place excessive weight on it.

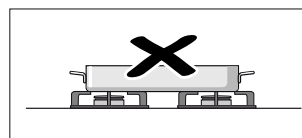

Do not heat a cooking vessel (e.g. roaster, pan, grill stone) on more than one burner at the same time. The resulting heat accumulation will damage the appliance.

Cleaning and maintenance

⚠ Warning – Risk of electric shock!

Do not use any high-pressure cleaners or steam cleaners, which can result in an electric shock.

⚠ Warning – Risk of burns!

The accessible parts become very hot when in operation. Never touch hot parts. Keep children at a safe distance.

Caution!

Risk of surface damage

Do not use these cleaners

- harsh or abrasive cleaning agents
- oven cleaners
- corrosive or aggressive cleaners, or those containing chlorine
- cleaning agents with a high alcohol content
- hard and scratchy sponges, brushes or scouring pads

If such an agent comes into contact with the appliance, wash it off immediately with water.

Thoroughly wash out new sponge cloths before using them!

Cleaning the appliance

Clean the appliance after each use once it has cooled down. Remove spilt liquids immediately and do not allow any food remains to burn on.

Make sure that the ventilation openings under the pan support are always clean. The ventilation openings must not be covered.

Dry the burners thoroughly after cleaning. Only operate the appliance when the burners are dry. Damp burners can cause ignition problems and/or an unstable flame.

During assembly, make sure that the burner parts (catch tappets) are in the correct position. All parts must be straight.

Appliance part/surface	Recommended cleaning
Stainless steel surfaces	Use soapy water and dry with a soft cloth. Only use a minimal amount of water when cleaning so that no water enters the appliance. Soak burnt-on remains with a small amount of soapy water; do not scour. Remove heavy soiling or yellow discoloration caused by heat using our stainless steel cleaning agent (item no. 00311499).
Pan supports	Carefully remove them for cleaning. Soak in the sink. Clean using a scrubbing brush and detergent. Clean the area around the rubber buffers carefully so that they do not become detached. Rinse with clean water before leaving to dry. Do not clean them in the dishwasher.
Burner parts	Use soapy water and dry with a soft cloth. Make sure that the openings are not blocked. Take care that no small parts are lost. Do not clean them in the dishwasher.
Control knob	The soapy cloth must not be too wet. Dry with a soft cloth.

Burnt-on dirt

For hard-to-remove, burnt-on dirt, you can order a cleaning gel from our online shop, from your specialist retailer or our after-sales service (item number 00311859). It is suitable for pan supports and the stainless-steel recess. If necessary, let the dirt soak overnight. Follow the instructions on the cleaning agent.

Caution!

Damage to the surface

Do not use the cleaning gel on the burner parts.

Burner discolouration

After extended use, the brass burner parts take on a darker colour as a result of the oxidation process that occurs naturally. The discolouration does not affect their serviceability.

Trouble shooting

Malfunctions often have simple explanations. Please read the following notes before calling the after-sales service.

Warning – Risk of electric shock!

Incorrect repairs are dangerous. Repairs may only be carried out by one of our trained after-sales engineers. If the appliance is faulty, unplug the mains plug or switch off the fuse in the fuse box. Contact the after-sales service.

Disruption	Possible cause	Solution
The burner will not ignite when it is switched on.	Power supply disconnected.	Turn all control knobs to 0. Check the fuse box to see whether the circuit breaker has tripped.
The burner will not ignite when it is switched on. The illuminated ring behind the control knob is flashing orange and white alternately.	Burner or gas supply fault.	Turn all control knobs to 0. Check: <ul style="list-style-type: none"> ● Are the burner parts positioned correctly? ● Is the main gas tap open? ● Is the burner clean and dry? ● Is there air in the line following initial connection or a cylinder change (in the case of liquid gas)? ● Is the gas cylinder empty (in the case of liquid gas)?
The burner will not ignite when it is switched on. All the illuminated rings behind the control knobs are lit white for 10 seconds after switch-on. Then the illuminated ring around the active control knob is lit orange.	Demo mode is activated.	Deactivate demo mode.
The burner will not ignite when it is switched on. The illuminated ring behind the control knob is flashing yellow and magenta alternately.	Electronics fault	Turn all control knobs to 0 and disconnect the appliance from the mains power supply for one minute (switch off the circuit breaker or pull out the plug). Reconnect the appliance. The illuminated rings around the control knobs will be lit green for a few seconds and then turn yellow. Wait until the illuminated rings switch off. Then turn any of the control knobs to any of the heat settings and then back to 0. Switch on the burner. If the illuminated ring starts flashing yellow and magenta again, call our after-sales service.
The burner goes out while the appliance is in operation. The illuminated ring behind the control knob is flashing orange and white alternately.	Safety switch-off function: No actions have been performed for an extended period.	Turn all control knobs to 0, and then switch them back on if you wish to continue using the appliance.
The burner goes out while the appliance is in operation. The illuminated ring behind the control knob is flashing orange and white alternately.	Domestic power failure: Following a power failure, the appliance will remain switched off for safety reasons.	Turn all control knobs to 0, and then switch them back on if you wish to continue using the appliance.
There is a smell of gas in the kitchen.	Gas may be leaking out where the gas cylinder is connected.	Check that the gas cylinder connection is not leaking. Open windows and ensure the room is well ventilated.

The appliance panelling becomes slightly raised at the corners when it is in operation.	The metal from which the cooktop is made expands as it heats up.	This is normal. It will contract again once it has cooled down.
---	--	---

Notes

- Each time the mains power is switched on or following a power failure, a sound is produced when the gas valves are started up. The illuminated rings around the control knobs will be lit green for a few seconds and then turn yellow. Wait until the illuminated rings switch off.
- When the gas cooktop is switched on, the electronics open up the gas supply, which produces a short sound. A sound can also be heard when the setting is changed. This is normal.

Demo mode

The demo mode is activated if all of the illuminated rings around the control knobs light up white for 10 seconds after switching on the appliance. The burner does not ignite. The illuminated ring around the active control knob lights up orange.

You can deactivate the demo mode as follows:

- 1 Turn all of the control knobs to 0. Disconnect the appliance from the mains power supply. Wait at least 30 seconds.
- 2 Reconnect the appliance. The illuminated rings around the control knobs light up green for a few seconds and then turn yellow. Wait until the illuminated rings switch off.
- 3 Then deactivate demo mode within three minutes as follows:
Turn any of the control knobs anti-clockwise to position 12.
- 4 Turn the control knob clockwise to position 1.
- 5 Turn the control knob anti-clockwise to position 0. Wait until the illuminated ring lights up yellow.
- 6 Turn the control knob clockwise to position 1. The illuminated ring lights up green.
Wait for five seconds. The illuminated ring now turns yellow.

Demo mode has now been deactivated. **To save the setting, always exit the menu as follows:**

- 7 Turn the control knob to 0. Then turn the control knob anti-clockwise to position 12. Turn the control knob clockwise to position 1. Turn the control knob anti-clockwise to position 0. Wait until the illuminated ring goes out.

After-sales service

Our after-sales service is there for you if your appliance needs to be repaired. We will always find an appropriate solution, also in order to avoid after-sales personnel having to make unnecessary visits.

E number and FD number

When calling us, please quote the full product number (E no.) and the production number (FD no.) so that we can provide you with the correct advice. The rating plate that features these numbers can be found on the underside of the appliance.

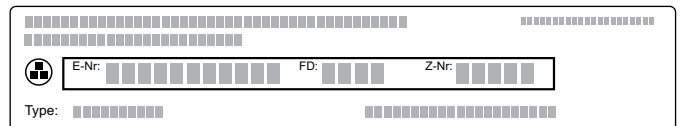

To save time, you can make a note of the numbers for your appliance and the telephone number of the after-sales service in the space below in case you need them.

E no.	FD no.

After-sales service ☎

Please note that a visit from an after-sales service engineer is not free of charge in the event that the appliance has been misused, even during the warranty period.

Please find the contact data of all countries in the enclosed customer service list.

To book an engineer visit and product advice

- GB** 0344 892 8988
Calls charged at local or mobile rate.
- IE** 01450 2655
0.03 € per minute at peak.
Off peak 0.0088 € per minute.
- AU** 1300 368 339
- NZ** 09 477 0492

Trust the expertise of the manufacturer, and rest assured that the repair will be carried out by trained service technicians using original spare parts for your domestic appliance.

目錄

用途	16
重要安全資訊	17
損壞原因	19
環境保護	19
節能	19
符合環保規定的廢棄處理	19
請熟悉您的電器。	20
瓦斯爐	20
控制 旋鈕	20
照明裝置的視覺訊號	20
爐頭的個別零件	21
操作電器	21
開啟	21
煨燉設定	21
電子火候監控與自動再點火	22
關閉	22
餘熱指示燈	22
安全 關閉	22
設定與提示總表	22
烹調 與燒烤的祕訣	22
關於鍋具的提示與資訊	23
適用的 烹調工具	23
使用時 的注意事項	23
清潔與維護	24
清潔電器	24
燒焦的污垢	24
燃燒器泛黃	24
疑難排解	25
展示模式	26
售後服務	26
產品編號及製造編號	26

關於產品、配件、備品與保養的其他資訊，請參閱
www.gaggenau.com/zz/store 與線上商店
www.gaggenau-eshop.com

用途

請詳細閱讀說明。才可以安全並正確地使用本電器。請妥善保管說明手冊及安裝說明，以便未來使用或交給下一位持有人。

本產品僅可安裝於廚房使用。請遵守原廠安裝說明。

本電器必須根據隨附的安裝說明進行安裝。

在開箱後請檢查電器是否有損壞。若在運送過程中已發生損壞，請勿連接本電器。

務必由持有執照的專業人士將電器接電。因不當連接而造成的損壞，不在保固範圍之內。若您想要將本電器轉換成使用不同種類的瓦斯，請聯絡客服中心。

本電器主要用於室內與居家環境。本電器僅適用於準備食物和飲品，不可當做暖爐來使用。操作時務必在場監督。僅供室內使用。

請不要將本電器安裝在船隻或運輸工具上。

本電器僅適用於最高海拔 2000 公尺以下地區。

本產品不適合與外部計時器或遙控操作搭配使用。

請勿使用蓋板。其可能因過熱而造成意外事故，如起火或材料碎裂。

只能使用經我們認可的安全裝置或兒童護欄。不適當的安全裝置或兒童護欄可能會造成意外。

8 歲以上的兒童，身體、感官或精神有障礙者，以及欠缺使用此產品經驗和知識者，可由監護人在旁監督或指導如何安全使用並明瞭其危險性後，使用本產品。

不可讓兒童將本產品當作玩具、或在本產品周圍玩耍。15 歲以上兒童可於有人在旁監督的情況下進行本產品的清潔與保養。

8 歲以下的兒童須與本電器及其電源線保持距離。

若電器將有一段長時間不使用，請關閉瓦斯供給管線上的安全閥。

⚠ 重要安全資訊

⚠ 警告 – 聞到瓦斯味時該做的事！

漏出的瓦斯可能會導致爆炸。

若聞到瓦斯味 或發現瓦斯安裝上有缺陷：

- 立刻關閉瓦斯供給或關閉 瓦斯罐的閥。
- 立刻 滅掉所有暴露出的火焰與煙霧。
- 請勿 開啟任何光源或電器電源，以及將任何插頭從插座拔掉。請勿在建築物裡使用電話或手機。
- 打開窗戶 並使房間內通風。
- 請聯絡售後服務 中心或瓦斯行。

⚠ 警告 – 窒息風險！

使用瓦斯爐將會導致安裝有本電器的房間內產生熱、濕氣及燃燒產物。請確保安裝本電器的房間內有足夠的通風。請務必將通風口打開或使用機械式抽風機（例如抽油煙機）。若密集地或持續地使用本電器，需有額外的通風（例如打開窗戶）或更有效的通風（例如將既有的機械式抽風機開大一點）。

⚠ 警告 – 火災風險！

- 高溫油脂可能會快速點燃。請務必看守並注意高溫油脂的使用。請勿使用水撲滅正在燃燒的油脂。關閉加熱區。小心使用鍋蓋、滅火毯或類似的物品來滅火。
- 加熱區變得非常熱。切勿將易燃物品放置於爐具上。切勿將物品放置於爐具上。
- 電器變得高溫且易燃物可能會著火。請勿在本電器的下方或鄰近處放置或使用易燃物品（例如：噴罐、清潔劑）。請勿在本電器的上方或內部放置易燃物品。
- 如果瓦斯加熱板運作中卻沒有放置任何廚具，此時瓦斯加熱板將產生高溫。本電器與其上方的抽油煙機可能會損壞或起火。抽油煙機的濾網上所殘留的油脂可能會引起點火。務必將廚具放妥之後再開啟瓦斯燃燒器。
- 假如燃燒器在 15 秒後還是沒有點燃，請關閉控制旋鈕並開啟房間內的門窗。再次開啟燃燒器前，需等待至少 1 分鐘。

⚠ 警告 – 燙傷風險！

- 電器在運作時會發燙。清潔前，請務必等待電器完全冷卻。
- 加熱區及周圍區域（特別是爐具周圍）會變得非常熱。切勿觸碰高溫表面。兒童應保持安全距離。
- 運作時可接觸部分會變得非常高溫。請勿觸碰高溫部件。兒童應保持安全距離。
- 當電器的上蓋關閉時，熱能會累積。請在本電器完全冷卻後再使用電器上蓋。請勿在電器上蓋關閉的狀態下開啟本電器的電源。請勿放置食物在電器上蓋或用其來幫助食物保溫。
- 空鍋具放在運轉中的瓦斯加熱板上會變得非常燙。請勿加熱空的鍋具。
- 若液態瓦斯罐沒有垂直擺放好，液態丙烷 / 丁烷可能會流入電器內。強烈猛烈的火焰可能會因此從燃燒器冒出。組件可能會損壞並隨著時間開始外漏，瓦斯也因此會無法控制地竄出。兩者皆會導致燙傷。使用液態瓦斯罐時請務必垂直擺放好。

⚠ 警告 – 受傷風險！

- 不當維修會造成危險。請由受過本公司訓練的售服工程師進行維修或更換損壞的電源·瓦斯管線。烤箱如有故障，請拔掉烤箱插頭或更換保險絲盒內的保險絲。關閉瓦斯供給。請聯絡客服中心。
- 有缺陷或損傷的電器非常危險。電器若有缺陷請勿開啟其電源。請拔掉烤箱插頭或關閉保險絲盒內的斷路器。關閉瓦斯供給。請聯絡客服中心。
- 尺寸不合適的平底鍋、已受損或沒放置好的平底鍋 將導致受傷。請遵照鍋具隨附的指示。

⚠ 警告 – 觸電與嚴重傷害風險！

- 電源線上的絕緣層可能會因接觸高溫部分而融化。請勿讓電源線接觸電器高溫部分。
- 切勿使用任何高壓或蒸氣清潔器，以免觸電。
- 損壞的電器可能導致觸電。請勿開啟損壞電器的電源。請拔掉電器插頭或關閉保險絲盒內的斷路器。請聯絡客服中心。
- 不當維修會造成危險。維修作業需由我們的專業售後服務工程師負責。電器如有故障，請拔掉電器插頭或更換保險絲盒內的保險絲。請聯絡客服中心。

損壞原因

注意!

- **對鄰近電器或廚房用具造成熱損壞：**當電器運轉了一段時間後會產生熱與濕氣。此時需要有額外的通風。打開窗戶或啟動排油煙機將電器排出的空氣及溼氣排放到建築物外面。
- **熱能累積會導致電器損壞：**請勿一次使用一個以上的燃燒器來加熱烤盤、平底鍋或燒烤石。
- **故障：**當電器未使用時，請務必將控制旋鈕轉至「關閉」位置。

環境保護

下一個章節裡，我們明列了節能秘訣與電器廢棄處理相關資訊。

節能

- 選擇和您的鍋具大小相近的燃燒器。將鍋具置於中央。
- 少量烹調時請使用小型湯鍋。少量烹調時使用大型湯鍋會消耗過多的能源。
- 使用適合湯鍋的蓋子。烹調時不加蓋將會消耗較多的能耗。玻璃蓋可方便您不打開蓋子便看到裡面的情況。
- 使用少量的水烹調。既省能源又能保存蔬菜中的維生素和礦物質。
- 及時切換至較低的加熱設定。如此可以節省能源。

符合環保規定的廢棄處理

請以環保的方式將包裝丟棄。



本電器 根據歐盟關於使用過的電器及電子產品的指令 2012/19/EU (使用過的電器及電子產品 - WEEE) 貼有 相關標籤。該指令規定歐盟範圍內 舊電器退還及回收的框架。

爐頭的個別零件

請確保爐頭的個別零件皆安裝於正確位置且平直無彎曲，否則可能出現點火或操作問題。

請固定爐頭前端和爐頭環，以便讓爐頭的固定鎖能扣入對應的插槽內。爐頭是否對齊爐頭環並不重要。

提示：如果爐頭零件是依某種角度裝入，電器將無法使用。

標準爐頭和高功率爐頭的個別零件

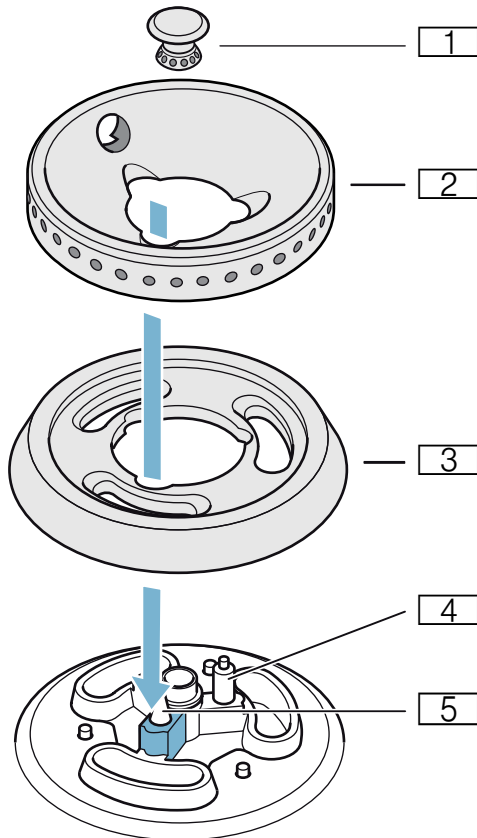

- 1 燃燒器蓋
- 2 燃燒器圓環
- 3 燃燒器前端
- 4 點火器
- 5 熱電偶

操作電器

提示

- 只能使用指定配件。請勿遮蓋不鏽鋼凹槽（例如用鋁箔蓋住）。
- 爐頭和點火器必須保持清潔乾燥。
- 請先確認爐頭和所有燃爐零件都已正確安裝，然後才能點燃。
- 一個爐頭點火時，其他爐頭的也會出現點火器的火花。
- 當瓦斯電器正在點燃時，請勿觸碰點火器。
- 保持電器的清潔非常重要。若點火器骯髒，點火時可能會出現問題。定期使用小型非金屬刷子清潔點火器。請小心維護，避免點火器受到嚴重撞擊。
- 從設定 3 切換到設定 4 或以上時，爐頭會暫時切換至最大輸出。這樣可以讓爐頭環的點火效果達到最佳狀態。
- 請勿遮蓋瓦斯爐後方的通風口。
- 啟動瓦斯爐後，電子設備會打開瓦斯供應，此時會聽到一個短促的聲音。這是正常的現象。
- 停電時，電器無法運作。電器會關閉瓦斯供應。

開啟

瓦斯爐具備自動快速點火功能。

- 1 請在爐架上放置適當的鍋具。
- 2 壓下您所選擇的爐頭控制旋鈕，並順時針或逆時針轉動它到您需要的加熱設定。爐頭將自動點火。

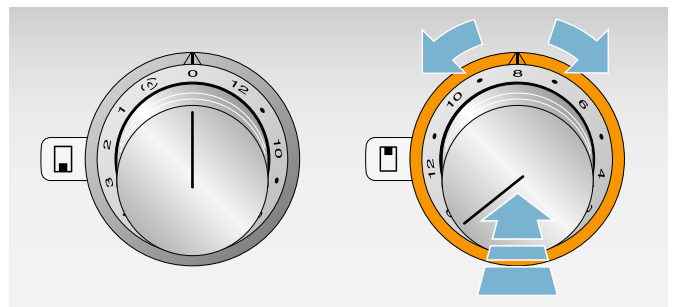

旋轉控制旋鈕來進行加熱設定。

⚠ 警告 – 爆燃風險！

假如燃燒器在 15 秒後還是沒有點燃，請關閉控制旋鈕並開啟房間內的門窗。再次開啟燃燒器前，需等待至少 1 分鐘。

煨燉設定

透過煨燉設定，可切換瓦斯火焰的開啟和關閉。您可藉此融化巧克力或為調製的醬汁加熱等。

將控制旋鈕轉到 (C)。切換開關會需要 10 到 50 秒時間。

電子火侯監控與自動再點火

本瓦斯爐具備電子火侯監控功能以保護您的安全。瓦斯爐使用中若火熄滅（例如因為有風），本電器的燃燒器將自動再點火。

如果無法重新點火（例如因為液體或食物溢出，而且殘渣留在燃燒器上），本電器會關閉瓦斯供應，同時在控制旋鈕後方的發光圓環將會閃爍。

將控制旋鈕轉至 0。待本電器冷卻至適當溫度後再確認所有燃燒器零件的位置是否正確。檢查燃燒器或點火器是否被食物殘渣等所覆蓋。→ "疑難排解" 第 25 頁

關閉

請將控制旋鈕轉至 0 的位置，本電器的電子裝置將會關閉瓦斯供應。

⚠ 警告 – 燙傷風險！

當電器的上蓋關閉時，熱能會累積。請在本電器完全冷卻後再使用電器上蓋。請勿在電器上蓋關閉的狀態下開啟本電器的電源。請勿放置食物在電器上蓋或用其來幫助食物保溫。

餘熱指示燈

關機後控制旋鈕後方的照明裝置閃爍，表示電器尚未降溫至可安全碰觸的程度。

安全 關閉

本電器具備安全關閉裝置以保護您的安全。電器運轉了一段長時間後會自動關閉。電器會依據設定（火力設定 12 = 1 小時，火力設定 1 = 4 小時），決定要等候多久時間後關閉。控制旋鈕後方的發光圓環會交替閃爍橘燈和白燈。

將控制旋鈕轉動到 0 的位置。現在您可以照常重新啟動電器。

設定與提示總表

加熱設定	烹調方法	例如
12	加熱	水、清湯
	燙煮	蔬菜
10-12	燒炙	肉類、炒菜 / 平底鍋油煎料理
	高溫油炸	肉、馬鈴薯
7-10	開蓋燉燉	液體、麵團類食物
6-8	烘焙	麵粉類食物
	以適中溫度油煎	禽肉、魚類
4-6	低溫油煎	油煎香腸、洋蔥、蛋類料理
	加熱	蔬菜、湯、燉菜
	油炸	炸薯條、酥皮點心
3-4	打開蓋水煮	餃子、煲煮過的香腸
	解凍	冷凍食品
	燉煮	橄欖牛肉卷
2-4	燉	蔬菜
	加蓋燉燉	湯、蔬菜
燉燉設定 – 最高 3	浸泡	米、米飯布丁、穀類
燉燉設定	融化、保溫	巧克力、牛油

烹調 與燒烤的祕訣

設定列表裡的數值僅能當做參考數值。所須的加熱不僅依照食物的類型與狀態有所不同，也受到鍋子的尺寸與內裝物的影響。

由於本產品為高效能瓦斯爐，因此可快速加熱油脂和油。請千萬不可放置瓦斯爐不管，油脂可能會引發點火，食物可能會燒起來。

最好能使用後方烹調區來準備肉品，會花比較久的時間。

最好能使用高輸出燃燒器來料理快速烹調食物、油炸以及大量燒炙食物。

關於鍋具的提示與資訊

以下提供您節能並防止鍋具損壞的資訊和提示。

適用的烹調工具

爐頭	建議的鍋底直徑	最小鍋底直徑
標準輸出功率爐頭	200 - 240 公釐	90 公釐
高輸出功率爐頭	240 - 280 公釐	90 公釐

不應使用直徑小於 90 公釐或是大於 280 公釐的鍋具。如果您是使用較大的鍋具，其直徑不應超過電器的邊緣。

使用時的注意事項

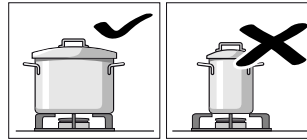

請使用適合各燃燒器尺寸
的鍋子或平底鍋。

請勿在大的燃燒器上使用
過小的鍋子或平底鍋。火
焰不可碰觸到鍋子的邊
緣。

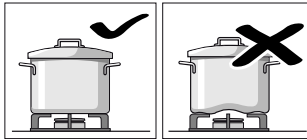

請勿使用已損壞的鍋子或
平底鍋，這樣的器具無法
在瓦斯爐上平均放置而可
能導致傾斜外漏。

請務必使用帶有厚平底
的鍋子或平底鍋。

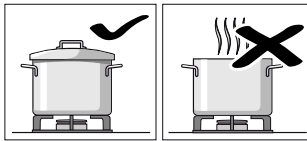

請勿在沒有使用蓋子的狀
態下烹調並確保蓋子的尺
寸合適。如此會造成能源
浪費。

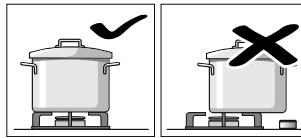

請務必將鍋子或平底鍋擺
放在燃燒器的中間，否則
會傾斜外漏。

請勿在靠近控制旋鈕的燃
燒器上放置過大的鍋子。
這些部分可能會因為高溫
而損壞。

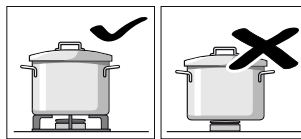

將鍋子或平底鍋放置於爐
架上，務必不要直接放在
燃燒器上。

使用本電器前請確認爐架
與爐芯帽的位置有擺放正
確。

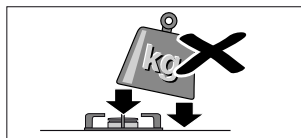

鍋子或平底鍋必須小心地
放置在瓦斯爐上。

請勿敲打本瓦斯爐以及於
上方放置過重的物品。

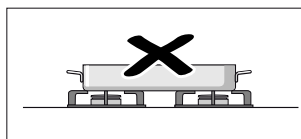

請勿同時使用一個以上的
燃燒器來加熱烹調器具
(例如烘烤器、平底鍋、
燒烤石)。所有加熱的累
積能量將導致電器損壞。

清潔與維護

⚠ 警告 – 觸電風險！

切勿使用任何高壓或蒸氣清潔器，以免觸電。

⚠ 警告 – 燙傷風險！

運作時可接觸部分會變得非常高溫。請勿觸碰高溫部件。兒童應保持安全距離。

注意！

小心損害表面

請勿使用以下的清潔用品

- 強效或腐蝕性的清潔劑
- 爐用清潔劑
- 具腐蝕性或強效清潔劑，或含氯的清潔劑
- 含高酒精成份的清潔劑
- 硬質與易刮傷的海綿，刷子或百潔布

若瓦斯爐正面不慎接觸到此類清潔劑，請立即用清水洗淨。

使用前，請用新的海綿布徹底清潔！

清潔電器

每次使用完請在電器冷卻後做清潔。請立即清除溢出的液體，不要讓任何食物殘渣燃燒起來。

請確認在鍋架下方的通風口保持在乾淨的狀態。通風口絕不能被覆蓋住。

清潔完成後請徹底擦乾爐頭。請務必在爐頭乾燥的狀態下操作本電器。潮濕的爐頭將導致點火問題和 / 或火侯不穩定。

安裝時請確認爐頭零件（定位桿）裝於正確的位置。所有零件必須是平直無彎曲的。

電器零件 / 表面	推薦的清潔方式
-----------	---------

不鏽鋼表面	<p>請使用肥皂水清潔並以軟布擦乾。請確保清潔時使用最少量的水以避免水滲入電器內。</p> <p>請將燒焦的殘渣浸泡在少量的肥皂水裡，並請不要刷洗。</p> <p>請使用本公司的不鏽鋼清潔劑（品項編號 00311499）來去除頑固的髒污或因熱所導致的泛黃。</p>
鍋架	<p>清潔時請小心移開。浸泡在水槽裡。請使用刷子與清潔劑來清潔。</p> <p>請小心清潔橡膠緩衝條的四周以避免其脫落。</p> <p>請先用清水沖洗乾淨，然後晾乾。</p> <p>請勿使用洗碗機清洗。</p>

電器零件 / 表面	推薦的清潔方式
-----------	---------

爐頭零件	<p>請使用肥皂水清潔並以軟布擦乾。請確認開口處沒有受到阻塞。</p> <p>請注意沒有遺失任何小零件。</p> <p>請勿使用洗碗機清洗。</p>
控制旋鈕	<p>沾有肥皂水的布不可太濕。用軟布將其擦乾。</p>

燒焦的污垢

針對難以清除的燒焦污垢，可向售後服務中心購買清潔凝膠（品項編號 00311859）。本清潔凝膠適用於爐架與不銹鋼凹槽。若有需要可將污物浸泡隔夜。請遵循清潔劑上的指示。

注意！

造成表面損壞

請勿將清潔凝膠用於燃燒器的零件上。

燃燒器泛黃

長期使用後，黃銅製的燃燒器組件會因為自然發生的氧化作用而呈現較暗的顏色。此泛黃現象並不會影響其功能。

疑難排解

故障通常可被輕易排除。在聯絡客服中心前，請先閱讀下列說明。

⚠ 警告 – 觸電風險！

不當維修會造成危險。維修作業需由我們的專業售後服務工程師負責。電器如有故障，請拔掉電器插頭或更換保險絲盒內的保險絲。請聯絡客服中心。

破裂	可能原因	解決方法
發光圓環亮起時，燃燒器無法點火。	電源供應已中斷。	將所有的控制旋鈕轉至 0。請檢查保險絲盒內的斷路器是否故障。
發光圓環亮起時，燃燒器無法點火。 控制旋鈕後方的發光圓環會交替閃爍橘燈和白燈。	燃燒器或瓦斯供應故障。	請將所有的控制旋鈕轉至 0。 確認： <ul style="list-style-type: none"> ● 燃燒器零件是否安裝在正確的位置？ ● 主要瓦斯開關是否已打開？ ● 燃燒器是否清潔乾燥？ ● 管線內是否在首次連接後有空氣，或者更換過瓦斯桶（液態天然氣）？ ● 瓦斯桶內的瓦斯桶（液態天然氣）是否用完了？
發光圓環亮起時，燃燒器無法點火。 開啟電器電源後，所有控制旋鈕後方所有的發光圓環會亮起白燈 10 秒鐘。然後使用中的控制旋鈕周圍的發光圓環會亮起橘燈。	展示模式已啟用。	停用展示模式。
發光圓環亮起時，燃燒器無法點火。 控制旋鈕後方的發光圓環將會交替閃爍黃燈和紅燈。	電子裝置故障。	將所有的控制旋鈕轉至 0，切斷電器的電源供應一分鐘（關掉斷路器或拔掉電器插頭）。 重新連接電器的電源。控制旋鈕周圍發光圓環會亮起綠燈，數秒鐘後轉為黃燈。請靜候發光圓環關閉。然後將任一控制旋鈕轉至其中一個加熱設定，再轉回 0 的位置。 開啟燃燒器。如果發光圓環又再次開始閃黃燈和紅燈，請聯絡售後服務中心。
電器在使用時燃燒器熄滅。 控制旋鈕後方的發光圓環會交替閃爍橘燈和白燈。	安全關閉功能： 電器長時間無動作。	將所有的控制旋鈕轉至 0，如果要繼續使用電器，可以將它們重新開啟。
電器在使用時燃燒器熄滅。 控制旋鈕後方的發光圓環會交替閃爍橘燈和白燈。	住家停電 停電後，為了安全起見，電器仍會關閉。	將所有的控制旋鈕轉至 0，如果要繼續使用電器，可以將它們重新開啟。
廚房裡有瓦斯味。	瓦斯有可能從瓦斯桶連接處外洩。	請檢查瓦斯桶連接處是否有瓦斯外洩。打開窗戶，並確保房間內有足夠的通風。
電器在使用時面板的角落會微微上揚。	瓦斯爐所使用的金屬材質在加熱時會膨脹。	這是正常的現象。金屬在冷卻後會再次收縮。

提示

- 每次啟動主電源或是停電之後，瓦斯閥啟動時會發出聲音。控制旋鈕周圍發光圓環會亮起綠燈，數秒鐘後轉為黃燈。請等候發光圓環關閉。
- 啟動瓦斯爐後，電子設備會打開瓦斯供應，此時會聽到一個短促的聲音。設定變更時，也會聽到一個聲音。這是正常的現象。

展示模式

開啟電器後，若控制旋鈕周圍所有發光圓環亮白燈 10 秒鐘，即表示展示模式已啟用。燃燒器無法點火。使用中的控制旋鈕周圍的發光圓環亮起橘燈。

您可以依照下列指示來停用展示模式：

- 1 請將所有的控制旋鈕轉至 0。切斷電器的電源供應。等待至少 30 秒。
- 2 重新連接電器的電源。控制旋鈕周圍的發光圓環會亮起綠燈，數秒鐘後轉為黃燈。請等候發光圓環關閉。
- 3 然後依照下列指示在三分鐘內停用展示模式：將任一控制旋鈕逆時針轉至 12 的位置。
- 4 將控制旋鈕順時針轉至 1 的位置。
- 5 將控制旋鈕逆時針轉至 0 的位置。請等候發光圓環亮起黃燈。
- 6 將控制旋鈕順時針轉至 1 的位置。發光圓環會亮起綠燈。請稍候五秒。現在發光圓環會轉為黃燈。

展示模式隨即關閉。若要儲存設定，必須依照下列指示離開功能表：

- 7 將控制旋鈕轉至 0。然後將控制旋鈕逆時針轉至 12 的位置。將控制旋鈕順時針轉至 1 的位置。將控制旋鈕逆時針轉至 0 的位置。等候發光圓環熄滅。

售後服務

若您的電器需要維修，請聯絡我們的客服中心。我們一定會找出適合的解決方案，同時避免售後服務人員進行不必要的拜訪。

產品編號及製造編號

與我們聯絡時，請提供完整的產品編號 (E no.) 和製造編號 (FD no.)，以便我們提供正確的建議。您可在電器底部找到附有這些數字的銘牌。

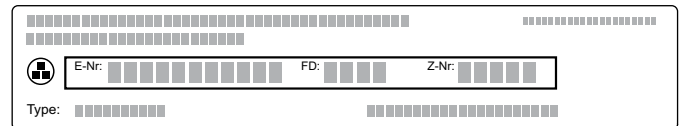

為節省時間，您可記下其編號及下方的售後服務中心電話，以備不時之需。

產品編號
(E no.)

生產序號
(FD no.)

售後服務中心 ☎

請注意，若未根據使用說明書使用本電器，即使在保固期內，售後服務技師到府服務非免費的服務。

各國的聯絡資訊請參閱附件的客戶服務列表。

預約技師到府服務以及產品諮詢

TW 0800 368 888
免付費電話

製造商的專業技術值得信賴；請放心將您的居家電氣用品交給我們，其維修工作皆由訓練精良的客服技術人員執行並且使用原廠備用零件。

Gaggenau Hausgeräte GmbH
Carl-Wery-Straße 34
81739 München
GERMANY
www.gaggenau.com

9001341618 (970921)
en, zh-tw



GAGGENAU