

**SIEMENS**



## Extractor hood

LE63MAC00, LE63MAC00B, LE66MAC00, LE66MAC00B



[siemens-home.bsh-group.com/welcome](https://siemens-home.bsh-group.com/welcome)

Instruction manual

Register  
your  
product  
online



## Table of contents

 <b>Important safety information</b> .....	3
 <b>Environmental protection</b> .....	5
Saving energy .....	5
Environmentally-friendly disposal .....	5
 <b>Operating modes</b> .....	6
Exhaust air mode .....	6
Air recirculation .....	6
 <b>Operating the appliance</b> .....	6
Switching the appliance on and off .....	6
Lighting .....	6
 <b>Cleaning and maintenance</b> .....	7
Cleaning agents .....	7
Removing and installing the filter .....	7
 <b>Trouble shooting</b> .....	8
Fault table .....	8
 <b>Customer service</b> .....	9
 <b>Accessories</b> .....	10

Additional information on products, accessories, replacement parts and services can be found at [www.siemens-home.bsh-group.com](http://www.siemens-home.bsh-group.com) and in the online shop [www.siemens-home.bsh-group.com/eshops](http://www.siemens-home.bsh-group.com/eshops)

## Important safety information

Read these instructions carefully. Only then will you be able to operate your appliance safely and correctly. Retain the instruction manual and installation instructions for future use or for subsequent owners.

The appliance can only be used safely if it is correctly installed according to the safety instructions. The installer is responsible for ensuring that the appliance works perfectly at its installation location.

This appliance is intended for domestic use and the household environment only. The appliance is not intended for use outside. Do not leave the appliance unattended during operation. The manufacturer is not liable for damage which is caused by improper use or incorrect operation.

This appliance is intended for use up to a maximum height of 2000 metres above sea level.

This appliance is not intended for use by persons (including children) with reduced physical, sensory or mental capabilities, or lack of experience and knowledge, unless they have been given supervision or instruction concerning use of the appliance by a person responsible for their safety.

Children must not play with, on, or around the appliance. Children must not clean the appliance or carry out general maintenance unless they are at least 8 years old and are being supervised.

Keep children below the age of 8 years old at a safe distance from the appliance and power cable.

Check the appliance for damage after unpacking it. Do not connect the appliance if it has been damaged in transport.

This appliance is not intended for operation with an external clock timer or a remote control.

### **Warning – Danger of suffocation!**

Packaging material is dangerous to children. Never allow children to play with packaging material.

**⚠ Warning – Danger of death!**

Risk of poisoning from flue gases that are drawn back in.

Always ensure adequate fresh air in the room if the appliance is being operated in exhaust air mode at the same time as room air-dependent heat-producing appliance is being operated.

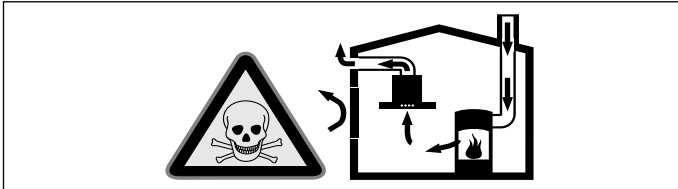

Room air-dependent heat-producing appliances (e.g. gas, oil, wood or coal-operated heaters, continuous flow heaters or water heaters) obtain combustion air from the room in which they are installed and discharge the exhaust gases into the open air through an exhaust gas system (e.g. a chimney).

In combination with an activated vapour extractor hood, room air is extracted from the kitchen and neighbouring rooms - a partial vacuum is produced if not enough fresh air is supplied. Toxic gases from the chimney or the extraction shaft are sucked back into the living space.

- Adequate incoming air must therefore always be ensured.
- An incoming/exhaust air wall box alone will not ensure compliance with the limit.

Safe operation is possible only when the partial vacuum in the place where the heat-producing appliance is installed does not exceed 4 Pa (0.04 mbar). This can be achieved when the air needed for combustion is able to enter through openings that cannot be sealed, for example in doors, windows, incoming/exhaust air wall boxes or by other technical means.

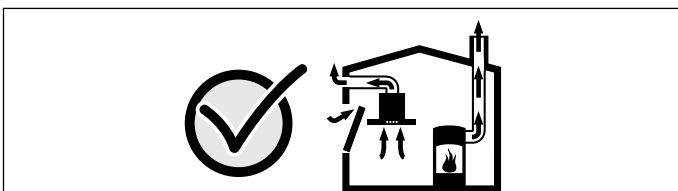

In any case, consult your responsible Master Chimney Sweep. He is able to assess the house's entire ventilation setup and will suggest the suitable ventilation measures to you.

Unrestricted operation is possible if the vapour extractor hood is operated exclusively in the circulating-air mode.

**⚠ Warning – Risk of fire!**

- Grease deposits in the grease filter may catch fire.

**Clean the grease filter at least once a month.**

Never operate the appliance without the grease filter.

- Grease deposits in the grease filter may catch fire. Never work with naked flames close to the appliance (e.g. flambéing). Do not install the appliance near a heat-producing appliance for solid fuel (e.g. wood or coal) unless a closed, non-removable cover is available. There must be no flying sparks.
- Hot oil and fat can ignite very quickly. Never leave hot fat or oil unattended. Never use water to put out burning oil or fat. Switch off the hotplate. Extinguish flames carefully using a lid, fire blanket or something similar.
- When gas burners are in operation without any cookware placed on them, they can build up a lot of heat. A ventilation appliance installed above the cooker may become damaged or catch fire. Only operate the gas burners with cookware on them.
- Operating several gas burners at the same time gives rise to a great deal of heat. A ventilation appliance installed above the cooker may become damaged or catch fire. Never operate two gas burners simultaneously on the highest flame for longer than 15 minutes. One large burner of more than 5 kW (wok) is equivalent to the power of two gas burners.

**⚠ Warning – Risk of burns!**

The accessible parts become very hot when in operation. Never touch hot parts. Keep children at a safe distance.

**⚠ Warning – Risk of injury!**

- Components inside the appliance may have sharp edges. Wear protective gloves.
- Items placed on the appliance may fall down. Do not place any objects on the appliance.
- The light emitted by LED lights is very dazzling, and can damage the eyes (risk group 1). Do not look directly into the switched on LED lights for longer than 100 seconds.

**⚠ Warning – Risk of electric shock!**

- A defective appliance may cause electric shock. Never switch on a defective appliance. Unplug the appliance from the mains or switch off the circuit breaker in the fuse box. Contact the after-sales service.
- Incorrect repairs are dangerous. Repairs may only be carried out and damaged power cables replaced by one of our trained after-sales technicians. If the appliance is defective, unplug the appliance from the mains or switch off the circuit breaker in the fuse box. Contact the after-sales service.
- Do not use any high-pressure cleaners or steam cleaners, which can result in an electric shock.

**Causes of damage****Caution!**

Risk of damage due to corrosion. Always switch on the appliance while cooking to avoid condensation. Condensate can produce corrosion damage.

Always replace faulty bulbs to prevent the remaining bulbs from overloading.

Risk of damage due to ingress of humidity into the electronic circuitry. Never clean operator controls with a wet cloth.

Surface damage due to incorrect cleaning. Clean stainless steel surfaces in the direction of the grain only. Do not use any stainless steel cleaners for operator controls.

Surface damage due to strong or abrasive cleaning agents. Never use strong and abrasive cleaning agents.

Risk of damage from returning condensate. Install the exhaust duct in such a way that it falls away from the appliance slightly (1° slope).

** Environmental protection**

Your new appliance is particularly energy-efficient. Here you can find tips on how to save even more energy when using the appliance, and how to dispose of your appliance properly.

**Saving energy**

- During cooking, ensure that there is a sufficient supply of air to enable the extractor hood to work efficiently and with a low level of operating noise.
- Adjust the fan speed to the amount of steam produced during cooking. Only use intensive mode when required. The lower the fan speed, the less energy is consumed.
- If cooking produces large amounts of steam, select a higher fan speed in good time. If the cooking steam has already spread around the kitchen, the extractor hood will need to be operated for longer.
- Switch off the extractor hood if you no longer require it.
- Switch off the lighting if you no longer require it.
- Clean and (if required) replace the filter at regular intervals in order to increase the effectiveness of the ventilation system and to prevent the risk of fire.
- Put the lid on to reduce cooking steam and condensation.

**Environmentally-friendly disposal**

Dispose of packaging in an environmentally-friendly manner.



This appliance is labelled in accordance with European Directive 2012/19/EU concerning used electrical and electronic appliances (waste electrical and electronic equipment - WEEE). The guideline determines the framework for the return and recycling of used appliances as applicable throughout the EU.

## Operating modes

### Exhaust air mode



The air which is drawn in is cleaned by the grease filters and conveyed to the exterior by a pipe system.

**Note:** The air must not be discharged into a flue that is used for exhausting fumes from appliances burning gas or other fuels (not applicable to appliances that only discharge the air back into the room).

- Before conveying the exhaust air into a non-functioning smoke or exhaust gas flue, obtain the consent of the heating engineer responsible.
- If the exhaust air is conveyed through the outer wall, a telescopic wall box should be used.

### Air recirculation



The air which is drawn in is cleaned by the grease filters and an activated carbon filter, and is conveyed back into the kitchen.

**Note:** To bind odours in air recirculation mode, you must install an activated carbon filter. The different options for operating the appliance in air recirculation mode can be found in the brochure. Alternatively, ask your dealer. The required accessories are available from specialist retailers, from customer service or from the Online Shop.



## Operating the appliance

The extractor hood can only be operated with the canopy open.

**Note:** Switch on the extractor hood when you start cooking and switch it off again several minutes after you have finished cooking. This is the most effective way of removing the kitchen fumes.

### Control panel



Explanation	
	Switches the lighting on/off
	Switches off the fan
1	Switch on the fan.
2	Switches on fan setting 2
3	Switches on fan setting 3

### Switching the appliance on and off

#### Switching on the appliance

Press button 1.

The extractor hood starts at fan setting 1.

#### Selecting the fan setting

Press the 2 or 3 button to set the corresponding fan setting.

#### Switching off the appliance

Press the  button.

### Lighting

The lighting can be switched on and off independently of the ventilation system.

Press the  button.

## Cleaning and maintenance

### **⚠ Warning – Risk of burns!**

The appliance becomes hot during operation. Allow the appliance to cool down before cleaning.

### **⚠ Warning – Risk of electric shock!**

Penetrating moisture may result in an electric shock. Clean the appliance using a damp cloth only. Before cleaning, pull out the mains plug or switch off the circuit breaker in the fuse box.

### **⚠ Warning – Risk of electric shock!**

Do not use any high-pressure cleaners or steam cleaners, which can result in an electric shock.

## Cleaning agents

To ensure that the different surfaces are not damaged by using the wrong cleaning agent, observe the information in the table. Do not use any of the following:

- Harsh or abrasive cleaning agents,
- Cleaning agents with a high alcohol content,
- Hard scouring pads or cleaning sponges,
- High-pressure cleaners or steam cleaners.

Wash new sponge cloths thoroughly before use.

Follow all instructions and warnings included with the cleaning agents.

Area	Cleaning agent
Stainless steel	Hot soapy water: Clean with a dish cloth and then dry with a soft cloth.  Clean stainless steel surfaces in the grind direction only.  Special stainless steel cleaning products are available from our after-sales service or from specialist retailers. Apply a very thin layer of the cleaning product with a soft cloth.
Painted surfaces	Hot soapy water: Clean using a damp dish cloth and dry with a soft cloth/towel.  Do not use any stainless steel cleaners.
Aluminium and plastic	Glass cleaner: Clean with a soft cloth.
Glass	Glass cleaner: Clean with a soft cloth. Do not use a glass scraper.
Controls	Hot soapy water: Clean using a damp dish cloth and dry with a soft cloth/towel.  Risk of electric shock caused by penetrating moisture.  Risk of damage to the electronics from penetrating moisture. Never clean operating controls with a wet cloth.  Do not use any stainless steel cleaners.

## Removing and installing the filter

The filter must be serviced regularly in order to guarantee efficient filtration of odours and grease.

### Metal grease filter

The metal grease filters should be cleaned every 30 operating hours or at least once a month.

### **⚠ Warning – Risk of fire!**

Grease deposits in the grease filter may catch fire. **Clean the grease filter at least once a month.** Never operate the appliance without the grease filter.

### Activated charcoal filter (only in circulating-air mode)

In order to guarantee efficient odour filtration, the filter must be serviced regularly.

The activated charcoal filters must be replaced at least every 4 months.

### Notes

- The activated charcoal filters are not included in the delivery. The activated charcoal filters can be obtained from specialist retailers, from our after-sales service or from the Online Shop.
- The activated charcoal filters cannot be cleaned or reactivated.

### Removing metal grease filter

The metal grease filters filter the grease out of kitchen steam. To keep them in good working order, the filters should be cleaned at least once a month.

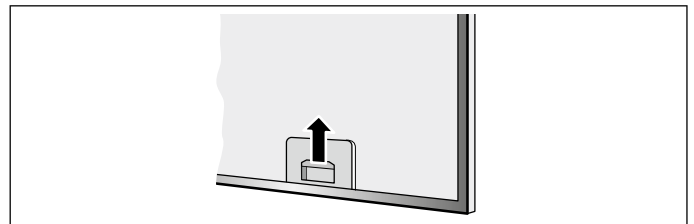

1. Open the lock on the metal grease filters and remove the filters from the retainer.

### Notes

- When you do this, take hold of the metal grease filters from underneath with your other hand. Make sure that the metal grease filters do not fall and damage the hob.
  - Fat may accumulate in the bottom of the metal grease filters. Hold the filters level to prevent fat from dripping out.
2. Clean the metal grease filters.
  3. Clean the inside of the appliance.

### Cleaning the metal mesh grease filters

### Notes

- Do not use any aggressive, acidic or alkaline cleaning agents.
- When cleaning the metal mesh grease filters, also clean the holder for the metal mesh grease filters in the appliance using a damp cloth.
- The metal mesh grease filters can be cleaned in the dishwasher or by hand.

**By hand:**

**Note:** You can use a special grease solvent for stubborn dirt. It can be ordered via the Online Shop.

- Soak the metal mesh grease filters in a hot soapy solution.
- Clean the filters with a brush and then rinse them thoroughly.
- Leave the metal mesh grease filters to drain.

**In the dishwasher:**

**Note:** If the metal mesh grease filters are cleaned in the dishwasher, slight discolouration may occur. This has no effect on the function of the metal mesh grease filters.

- Do not clean heavily soiled metal mesh grease filters together with utensils.
- Place the metal mesh grease filters loosely in the dishwasher. The metal mesh grease filters must not be wedged in.

**Installing the metal mesh grease filter**

1. Insert metal grease filter.
2. Fold up metal grease filter and engage the lock.

**Note:** Make sure that the filter lock engages properly.

**Changing the activated charcoal filter (only in circulating-air mode)**

In order to guarantee efficient odour filtration, the filter must be serviced regularly.

The activated charcoal filters must be replaced at least every 4 months.

**Notes**

- The activated charcoal filters are not included in the delivery. The activated charcoal filters can be obtained from specialist retailers, from our after-sales service or from the Online Shop.
- The activated charcoal filters cannot be cleaned or reactivated.

1. Remove the metal grease filters; see above.
2. Turn the old activated charcoal filters and pull them out of the retainer. **A**
3. Push the new activated charcoal filters into the retainer and turn. **B**

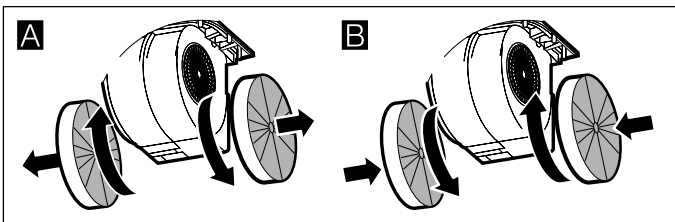

4. Fit the metal grease filters; see above.

## ? Trouble shooting

Malfunctions often have simple explanations. Please read the following notes before calling the after-sales service.

**⚠ Warning – Risk of electric shock!**

Incorrect repairs are dangerous. Repairs may only be carried out and damaged power cables replaced by one of our trained after-sales technicians. If the appliance is defective, unplug the appliance from the mains or switch off the circuit breaker in the fuse box. Contact the after-sales service.

**Fault table**

Problem	Possible cause	Solution
The appliance does not work	The plug is not plugged into the mains	Connect the appliance to the power supply
	Power cut	Check whether other kitchen appliances are working
	The fuse is faulty	Check in the fuse box to make sure that the fuse for the appliance is in working order
The lighting does not work.	The LED lights are defective.	You can read about this in the section entitled "Replacing the LED lights".



## Replacing the LED lights

### **⚠ Warning – Risk of electric shock!**

When changing the bulbs, the bulb socket contacts are live. Before changing the bulb, unplug the appliance from the mains or switch off the circuit breaker in the fuse box.

### **⚠ Warning – Risk of injury!**

The light emitted by LED lights is very dazzling, and can damage the eyes (risk group 1). Do not look directly into the switched on LED lights for longer than 100 seconds.

**Important!** Only use bulbs of the same type and wattage.

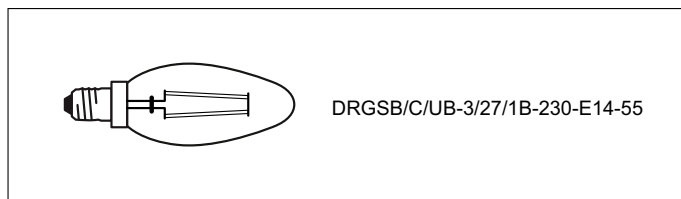

1. Lift the bulb cover slightly and move it towards the outside of the appliance.
2. Unscrew the bulb and replace it with a bulb of the same type.

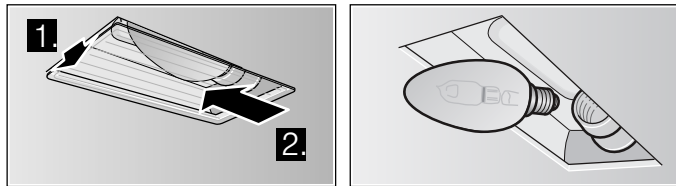

3. Fit the bulb cover.
4. Plug in the mains plug and switch the fuse back on.

## Customer service

When calling us, please give the product number (E no.) and the production number (FD no.) so that we can provide you with the correct advice. The rating plate with these numbers can be found inside the appliance (remove the metal mesh grease filter to gain access).

You can make a note of the numbers of your appliance and the telephone number of the after-sales service in the space below to save time should it be required.

E no.	FD no.
<b>After-sales service</b> 	

Please be aware that a visit by an after-sales engineer will be charged if a problem turns out to be the result of operator error, even during the warranty period.

Please find the contact data of all countries in the enclosed customer service list.

### **To book an engineer visit and product advice**

<b>GB</b>	0344 892 8999 Calls charged at local or mobile rate.
<b>IE</b>	01450 2655 0.03 € per minute at peak. Off peak 0.0088 € per minute.

Rely on the professionalism of the manufacturer. You can therefore be sure that the repair is carried out by trained service technicians who carry original spare parts for your appliances.

## Accessories

### Special accessories

Accessories	Order number
Activated charcoal filter	LZ10IMA00

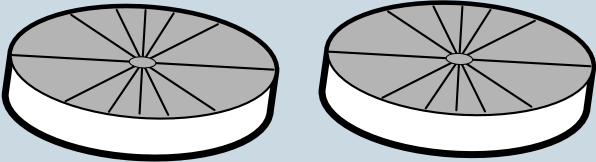

The image shows two identical circular activated charcoal filters. Each filter has a white outer ring and a grey inner disc. The grey disc is divided into several radial segments by thin lines, and there is a small central hole in the middle of each disc.



BSH Hausgeräte GmbH  
Carl-Wery-Str. 34, 81739 München  
GERMANY

[siemens-home.bsh-group.com](http://siemens-home.bsh-group.com)

Manufactured by BSH Hausgeräte GmbH under Trademark License of Siemens AG



9001310078  
980413