



SIEMENS



# Washing machine

WM14U840...

[siemens-home.bsh-group.com/welcome](https://siemens-home.bsh-group.com/welcome)

en Instruction Manual and Installation Instructions

Register  
your  
product  
online

## Your new washing machine

You have chosen a Siemens washing machine.

Please take a few minutes to read and become familiar with the advantages of your washing machine.

To meet the high quality demands required by Siemens, every washing machine that leaves our factory is carefully checked to ensure that it functions correctly and is in perfect condition.

For more information on our products, accessories, replacement parts and services, see our website [www.siemens-home.bsh-group.com](http://www.siemens-home.bsh-group.com) or contact our after-sales service centres.

If the operating and installation instructions describe different models, any differences will be pointed out at the relevant points in the text.



Read these operating and installation instructions before switching on the washing machine.

## Display rules

### **Warning!**

This combination of symbol and signal word indicates a possibly dangerous situation. Not heeding the warning can cause death or injuries.

### **Caution!**

This signal word indicates a possibly dangerous situation. Not heeding the caution can cause property and/or environmental damage.

### **Note/tip**

Information about the optimum use of the appliance/any other useful information.

### **1. 2. 3. / a) b) c)**

The steps are represented by numbers or letters.

■ / -

Lists are represented by a small box or a dash.

# Contents

## **Intended use** ..... 4

## **Safety instructions** ..... 5

Children/people/pets	5
Installation	6
Operation	8
Cleaning/Maintenance	10

## **Environmental protection** ..... 11

Packaging/used appliance	11
Tips on economical use	11

## **Positioning and connecting** ... 12

Standard accessories	12
Safety instructions	13
Installation surface	13
Installation on a base or a wooden joist floor	13
Installation on a platform with drawer	13
Installing the appliance in a kitchenette	13
Removing the transport locks	14
Removing the support struts	15
Hose and cable lengths	15
Water inlet	16
Water outlet	17
Alignment	18
Electrical connection	18
Before washing for the first time	19
Transportation	19

## **Get to know your appliance** ... 21

Appliance	21
Control panel	22
Touch display	23

## **Operating the appliance** ..... 24

Switching on the appliance/ selecting a programme	24
Putting the washing in the drum	25
Programme settings	26
Programme features	28
Options	30
Start the programme	31

Adding more laundry or removing laundry	31
Cancel the programme	32
Programme end	32

## **Appliance menu** ..... 32

Childproof lock	32
Audible signal settings	33
Appliance Setting	33

## **Home Connect** ..... 36

Calling up the Home Connect menu	37
Connecting to the home network and the Home Connect app	37
Energy management	39
Status	39
Activating/deactivating Wi-Fi	39
Resetting your network settings	40
Updating the software	40
Information on data protection	40
Declaration of Conformity	41

## **Intelligent dosing system** ..... 41

Intelligent dosing system in the detergent drawer	41
Initial use/filling the dispensers	41
Everyday use	42
Manual dosage	43

## **Laundry** ..... 44







Protecting your laundry and appliance	44
Sorting laundry	44
Starching	45
Dyeing/bleaching	45

## **Detergent** ..... 45

Correct selection of detergent	45
Saving energy and detergent	46

## **Overview of programmes** ..... 47

Selectable programme	47
----------------------	----

	<b>Sensors</b> .....	<b>52</b>
	Unbalanced load detection system .	52
	Aqua-Sensors .....	52
	<b>Cleaning and maintenance</b> ...	<b>52</b>
	Appliance housing/control panel. . .	52
	Drum .....	52
	Descaling. ....	52
	i-Dos detergent draw and its housing .....	53
	Drain pump is blocked .....	55
	The drain hose at the siphon is blocked .....	56
	Filter in the water supply is blocked	56
	<b>Faults and what to do about them</b> .....	<b>57</b>
	Emergency release .....	57
	Faults and what to do about them. .	58
	<b>After-sales service</b> .....	<b>61</b>
	<b>Consumption values table</b> . . .	<b>62</b>
	<b>Technical data</b> . ....	<b>63</b>
	<b>Aqua-Stop warranty</b> .....	<b>63</b>

## Intended use

- This appliance is intended for private domestic use only.
- Do not install or operate this appliance anywhere that is liable to experience frost and/or outdoor conditions. There is a risk that the appliance will be damaged if residual water in it freezes. If hoses freeze up, they may crack/burst.
- This appliance must only be used for washing domestic laundry, consisting of machine-washable items and hand-washable woollens (see label on item). Using the appliance for any other purpose is outside of the scope of its intended application and is forbidden.
- This appliance is suitable for operation with mains water and commercially available detergents and care products (must be suitable for use in washing machines).
- This appliance is intended for use up to a maximum height of 4000 metres above sea level.

### **Before you switch on the appliance:**

Check that there is no visible damage to the appliance. Do not operate the appliance if it is damaged. Should you have any problems, please contact your specialist dealer or our customer service.

Read and follow the operating and installation instructions and all other information provided with this appliance.

Retain the documents for subsequent use or for subsequent owners.

## Safety instructions

The following safety information and warnings are provided to protect you from injury and to prevent material damage to your surroundings.

It is nevertheless important to take the necessary precautions and to proceed with care when installing, maintaining, cleaning and operating the appliance.

### Children/people/pets

#### **Warning** **Risk of death!**

Children and other people who are unable to assess the risks involved when using the appliance may injure themselves or may find themselves in life-threatening situations. Therefore please note:

- The appliance may be used by children over the age of 8 years and by persons with reduced physical, sensory or mental capacity or by persons with a lack of experience or knowledge as long as they are supervised or have received instruction on how to use the appliance safely and they have understood the potential risks of using the appliance.
- Children must not play with this appliance.

- Do not allow children to clean or maintain this appliance unsupervised.
- Keep children under 3 years and pets away from this appliance.
- Do not leave the appliance unattended when children or other people who are unable to assess the risks are in the vicinity.

#### **Warning** **Risk of death!**

Children may lock themselves inside appliances and find themselves in a life-threatening situation.

- Do not position the appliance behind a door, as this may obstruct the appliance door or prevent it from opening completely.
- Once an appliance has reached the end of its life, pull the mains plug from the socket **before** severing the mains cable, and then destroy the lock on the appliance door.

#### **Warning** **Risk of suffocation!**

If allowed to play with the packaging/plastic film or packing components, children may become caught in these or pull them over their heads and suffocate.

Keep packaging, plastic film and packing components away from children.

**⚠ Warning**

**Risk of poisoning!**

Detergents and care products may result in poisoning if consumed.

If accidentally swallowed, seek medical advice. Keep detergents and care products out of the reach of children.

**⚠ Warning**

**Risk of burns!**

When washing at high temperatures, the glass in the appliance door becomes hot. Stop children from touching the appliance door when it is hot.

**⚠ Warning**

**Eye/skin irritation!**

Contact with detergents or care products may cause eye/skin irritation.

Rinse eyes/skin thoroughly if they/it come(s) into contact with detergents or care products. Keep detergents and care products out of the reach of children.

**Installation**

**⚠ Warning**

**Risk of electric shock/fire/  
material damage/damage to  
the appliance!**

If the appliance is not installed properly, this may lead to a dangerous situation. Ensure the following:

- The mains voltage on your power socket must match the rated voltage specified on the appliance (identification plate). The connected loads and the required fuse protection are specified on the identification plate.
- The mains plug and the protective contact socket must match and the earthing system must be correctly installed.
- The installation must have an adequate cross section.
- The mains plug must be freely accessible at all times. If this is not possible, in order to comply with the relevant safety regulations, a switch (all pole disconnection) must be built into the permanent installation in accordance with electrical installation regulations.
- If using a residual current circuit breaker, only use one that bears the following mark: . The presence of this mark is the only way to be sure that it fulfils all the applicable regulations.

**⚠ Warning****Risk of electric shock/fire/  
material damage/damage to  
the appliance!**

If the appliance's mains cable is altered or damaged, this may result in electric shock, short circuiting or fire due to overheating.

The mains cable must not be kinked, crushed or altered, and must not come into contact with any heat sources.

**⚠ Warning****Risk of fire/material damage/  
damage to the appliance!**

The use of extension cords or power strips may result in fire due to overheating or short circuiting.

Connect the appliance directly to an earthed socket that has been correctly installed. Do not use extension cords, power strips or multi-way couplers.

**⚠ Warning****Risk of injury/material  
damage/damage to the  
appliance!**

- The appliance may vibrate or move when in operation, potentially resulting in injury or material damage.

Place the appliance on a clean, even, solid surface and, using a spirit level to guide you, level it with the screw-in feet.

- If you take hold of any of the appliance's protruding parts (e.g. the appliance door) in order to lift or move it, these parts may break off and cause injury.

Do not take hold of any of the appliance's protruding parts in order to move the appliance.

**⚠ Warning****Risk of injury!**

- The appliance is very heavy. Lifting it may result in injury. Do not lift the appliance on your own.
- The appliance has sharp edges on which you could cut your hands. Do not take hold of the appliance by its sharp edges. Wear protective gloves to lift it.
- If the hoses and mains cables are not correctly routed, they may constitute a tripping hazard, which may result in injury. Route hoses and cables such that they do not constitute a tripping hazard.



## Caution!

### Material damage/damage to the appliance

- If the water pressure is too high or too low, the appliance may not be able to operate properly, and it may also result in material damage or damage to the appliance.  
Make sure that the water pressure in the water supply facility is at least 100 kPa (1 bar), and does not exceed 1000 kPa (10 bar).
- If the water hoses are altered or damaged, this may result in material damage or damage to the appliance. The water hoses must not be kinked, crushed, altered or severed.
- The use of hoses supplied by other brands to connect to the water supply may result in material damage or damage to the appliance. Use the hoses supplied with the appliance or genuine spare part hoses only.

- The appliance is secured for transportation by transport locking devices. If the transport locking devices are not removed before the appliance is operated, this may result in damage to the appliance.  
It is important to completely remove all transport locking devices before using the appliance for the first time. Make sure that you retain these transport locking devices separately. It is important to refit the transport locking devices if the appliance is to be transported, in order to prevent the appliance from being damaged in transit.

## Operation

### **Warning** **Risk of explosions/fire!**

Laundry that has been pretreated with cleaning agents that contain solvents, e.g. stain remover/cleaning solvent, may cause an explosion in the drum. Rinse the laundry thoroughly with water before washing it in the machine.



**⚠ Warning****Risk of poisoning!**

Poisonous fumes may be given off by cleaning agents that contain solvents, e.g. cleaning solvent.

Do not use cleaning agents that contain solvents.

**⚠ Warning****Risk of injury!**

- If you support your weight/sit on the appliance door when it is open, the appliance may tip over, which may result in injury.

Do not support your weight on the appliance door when it is open.

- If you climb onto the appliance, the worktop may break, which may result in injury.

Do not climb onto the appliance.

- If you reach into the drum while it is still rotating, you risk injuring your hands. Wait until the drum has stopped rotating.

**⚠ Warning****Risk of scalding!**

When washing at high temperatures, there is a risk of scalding if you come into contact with hot detergent solution (e.g. when draining hot detergent solution into a washbasin).

Do not reach into the hot detergent solution.

**⚠ Warning****Eye/skin irritation!**

Detergent and care products may spray out if the detergent drawer is opened while the appliance is in operation.

Rinse eyes/skin thoroughly if they/it come(s) into contact with detergents or care products. If accidentally swallowed, seek medical advice.

**Caution!****Material damage/damage to the appliance**

- If the amount of laundry in the appliance exceeds its maximum load capacity, it may not be able to operate properly, or this may result in material damage or damage to the appliance.

Do not exceed the maximum load capacity of dry laundry. Make sure you comply with the maximum load capacities specified for each of the programs.

- If you pour the wrong quantity of detergent or cleaning agent into the appliance, this may result in material damage or damage to the appliance.

Use detergents/care products/cleaning agents and softeners in accordance with the manufacturers' instructions.

## Cleaning/Maintenance

### **Warning**

#### **Risk of death!**

The appliance is powered by electricity. There is a risk of electric shock if you come into contact with live components. Therefore please note:

- Switch off the appliance. Disconnect the appliance from the power supply (pull out the plug).
- Never take hold of the mains plug with wet hands.
- When removing the mains plug from the socket, always take hold of the plug itself and never the mains cable, otherwise this may damage the mains cable.
- Do not make any technical modifications to the appliance or its features.
- Repairs and any other work on the appliance must only be conducted by our customer service or by an electrician. The same applies for replacing the mains cable (when necessary).
- Spare mains cables can be ordered from our customer service.

### **Warning**

#### **Risk of poisoning!**

Poisonous fumes may be given off by cleaning agents that contain solvents, e.g. cleaning solvent.

Do not use cleaning agents that contain solvents.

### **Warning**

#### **Risk of electric shock/material damage/damage to the appliance!**

If moisture penetrates the appliance, this may cause it to short circuit.

Do not use a pressure washer, steam cleaner, hose or spray gun to clean your appliance.

### **Warning**

#### **Risk of injury/material damage/damage to the appliance!**

The use of spare parts and accessories supplied by other brands is dangerous and may result in injury, material damage or damage to the appliance.

For safety reasons, use genuine spare parts and accessories only.

### **Caution!**

#### **Material damage/damage to the appliance**

Cleaning agents and agents for pretreating laundry (e.g. stain removers, prewash sprays, etc.) may cause damage if they come into contact with the surfaces of the appliance. Therefore please note:

- Do not allow these agents to come into contact with the surfaces of the appliance.
- Clean the appliance with nothing but water and a soft, damp cloth.
- Remove any detergent, spray or other residues immediately.



## Environmental protection

### Packaging/used appliance



Dispose of packaging in an environmentally-responsible manner.

This appliance is labelled in accordance with European Directive 2012/19/EU concerning used electrical and electronic appliances (waste electrical and electronic equipment - WEEE).

The guideline determines the framework for the return and recycling of used appliances as applicable throughout the EU.

### Tips on economical use

- Always fill the appliance with the maximum amount of laundry for each programme. → *Page 47*
- Wash normally soiled laundry without pretreating.
- For light and normal soiling in laundry, you can save energy and detergent.
- Dosing the detergent using the **intelligent dosing system** (i-Dos) helps to save both detergent and water.
- The selectable temperatures apply to the care labels on the textiles. The temperatures in the appliance may deviate from this so that you get the optimum mix of energy-saving and washing results.

- **Sleep mode:** If the appliance is not operated for a prolonged period (approx. 5 minutes), the Touch-Display lighting goes out before the programme starts and when the programme has ended to save energy, ▷ flashes. Touch any area of Touch-Display to activate the display backlighting. When the programme is running, most of the Touch-Display lighting goes out. Touch any area of Touch-Display to re-activate the lighting.
- **Automatic standby:** If the appliance is not operated for a prolonged period (at least 20 minutes, depending on the water level inside of appliance), it will automatically be put in standby mode before the programme starts or after the programme has ended. Press the power button  again to switch on the appliance.
 

**Note:** If Wi-Fi is switched on at the appliance, when it is in Energy saving mode, the appliance will not automatically be put in standby mode.
- If the laundry will be dried in a dryer, select the spin speed according to the dryer manufacturer's instructions.



## Positioning and connecting

### Standard accessories

**Note:** Check the appliance for transport damage. Never use a damaged appliance. If you have any complaints, contact the dealer from whom you purchased the appliance or our Customer Service.

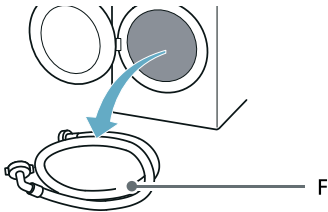
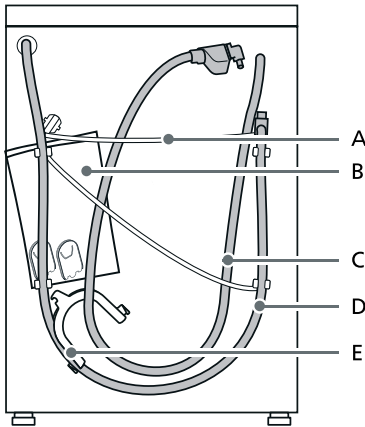

- A Mains lead
- B Bag:
  - Installation and operating instructions
  - Customer Service location directory\*
  - Warranty\*
  - Supplementary sheet for the installation and operating instructions\*
  - Cover caps for openings after the transport braces have been removed
  - Home Connect Installation Guides\*
- C Water inlet hose on aquaStop models
- D Water outlet hose
- E Elbow for securing the water outlet hose\*
- F Cold water inlet hose on Standard/Aqua-Secure models
- \* Depending on the model

**In addition,** a hose clamp (24 - 40 mm diameter, available from specialist retailers) is required to connect the water outlet hose to a siphon.

### Useful tool

- Spirit level for aligning
- Wrench with:
  - WAF13 for loosening the transport braces and
  - WAF17 for aligning the appliance feet

## Safety instructions

### **Warning**

#### **Risk of injury!**

- The appliance is very heavy. Be careful when lifting/transporting the appliance.
- When the appliance is lifted by its protruding parts (e.g. the appliance door), the components may break off and cause injuries. Do not lift the appliance by protruding parts.
- If the hose and mains cables are not routed properly, there is a risk of tripping and injury. Lay hoses and cables in such a way that there is no risk of tripping.

### **Caution!**

#### **Damage to the appliance**

Frozen hoses may rip/burst. Do not install the appliance in areas exposed to frost or outdoors.

### **Caution!**

#### **Water damage**

The connection points for the water supply hose and water drain hose are under high water pressure. To prevent leaks and water damage, you must follow the instructions in this section.

### **Notes**

- In addition to the safety information listed here, the local water and electricity supplier may have special requirements.
- If in doubt, have the appliance connected by a specialist.

## Installation surface

**Note:** The appliance must be stable aligned so that it does not move around.

- The installation surface must be firm and level.
- Soft floors/floor coverings are not suitable.

## Installation on a base or a wooden joist floor

### **Caution!**

#### **Damage to the appliance**

The appliance may "wander" and tip/topple from the base when spinning. The feet of the appliance must be secured with holding brackets. Order no. WMZ 2200, WX 975600, CZ 110600, Z 7080X0.

**Note:** On wooden joist floors, install the appliance:

- In a corner, if possible,
- On a water-resistant wooden board (min. 30 mm thick) which is screwed tightly to the floor.

## Installing the appliance in a kitchenette

### **Warning**

#### **Risk of death!**

There is a risk of electric shock if you touch live components. Do not remove the appliance covering plate.

### **Notes**

- Recess width of 60 cm required.
- Only install the appliance underneath a continuous worktop that is securely connected to adjacent cabinets.

## Removing the transport locks

### Caution!

#### Damage to the appliance

- The appliance is secured for transportation using transport locks. If the transport locks are not removed, the appliance may become damaged when it is operated. Before using the appliance for the first time, make sure that you completely remove all four transport locks. Keep the locks in a safe place.
- To prevent transport damage from occurring if the appliance is moved at a later date, you must refit the transport locks before transporting the appliance.

**Note:** Keep the screws and sleeves in a safe place.

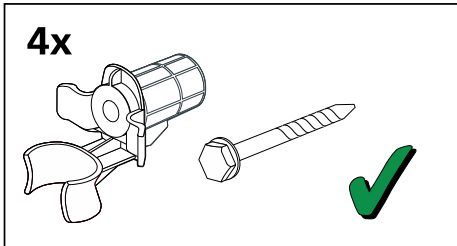

1. Take the hoses out of the holders.

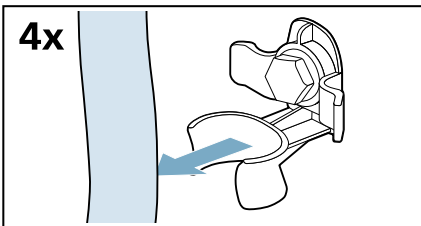

2. Unscrew and remove all four transport brace screws.

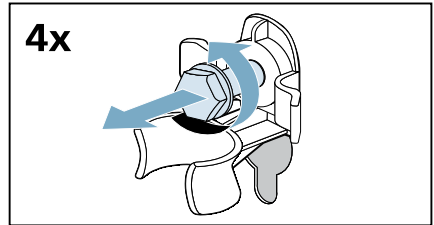

- a) Remove the mains cable from the holders.

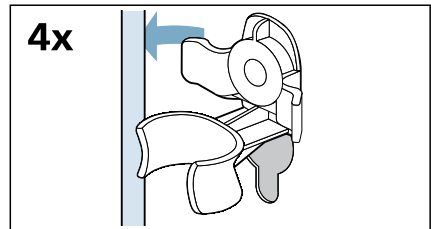

- b) Remove the sleeves.

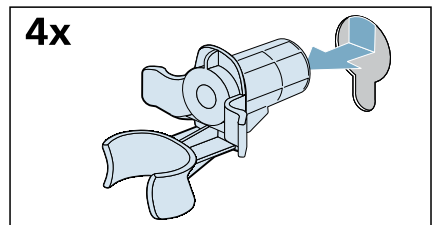

3. Fit the covers.

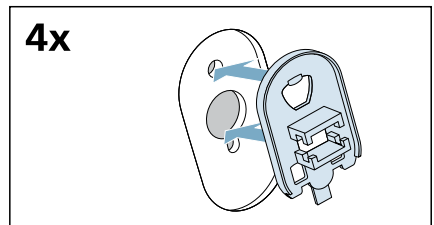

4. Lock the covers firmly in place by applying pressure to the snap-in hooks.

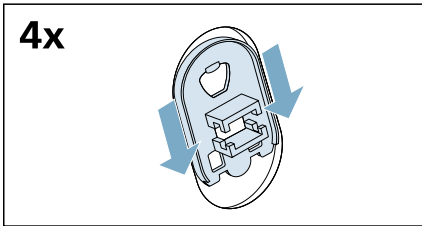

## Removing the support struts

1. Unscrew and remove all screws in the vertical transport struts.

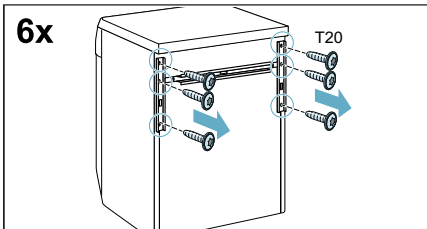

2. Remove the transport struts.

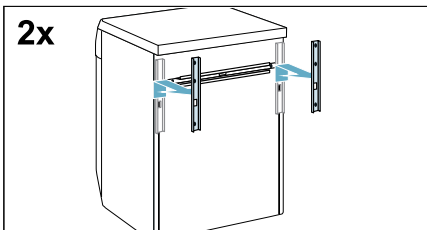

3. Undo and remove the screws on the horizontal transport strut.

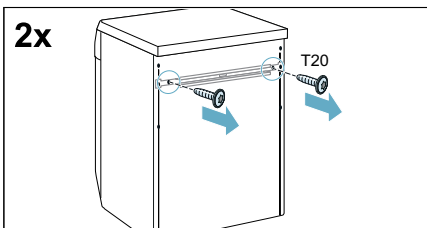

4. Remove the transport strut.

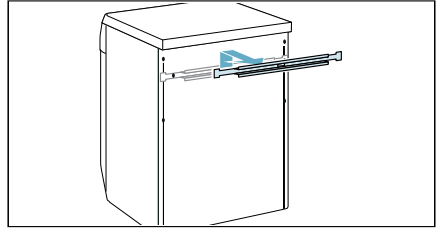

## Hose and cable lengths

### Connection on left side

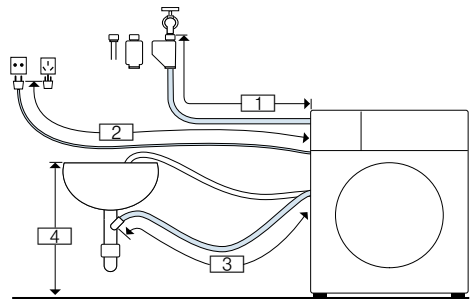

- 1 ~ 105 cm
- 2 ~ 150 cm
- 3 ~ 100 cm
- 4 0-max. 100 cm

or

### Connection on right side

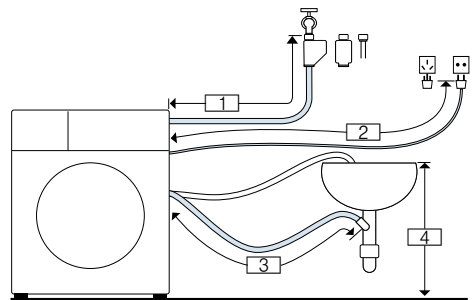

- 1 ~ 75 cm
- 2 ~ 190 cm
- 3 ~ 145 cm
- 4 0-max. 100 cm



**Tip:** If the supply hose is too short for your connection, you can order an extension from the after-sales service.

## Water inlet

### **Warning** **Risk of death!**

There is a risk of electric shock if you touch live components. Do not immerse the Aqua-Stop safety valve\* in water (it contains an electric valve).

\* Depending on the model

Observe the following when connecting the appliance:

### Notes

- Only operate the appliance using cold mains water.
- Do not connect the appliance to the mixer tap of an unpressurised hot-water boiler.
- Do not use a used supply hose. Only use the supply hose supplied or one that was purchased from an authorised specialist retailer.
- Do not bend, squash, modify or cut through the water supply hose (otherwise its strength is no longer guaranteed).
- Only tighten the screw connections by hand. If the screw connections are tightened too much with a tool (pliers), the thread may be damaged.

### Optimum water pressure in the supply network

**At least** 100 kPa (1 bar)

**Maximum** 1000 kPa (10 bar)

When the tap is open, the water flow is at least 8 l/min.

If the water pressure is higher than this, a pressure-reducing valve must be installed.

## Connection

1. Connect the water supply hose to the water tap ( $\frac{3}{4}$ " = 26.4 mm) and to the appliance:
  - Model: **Standard**

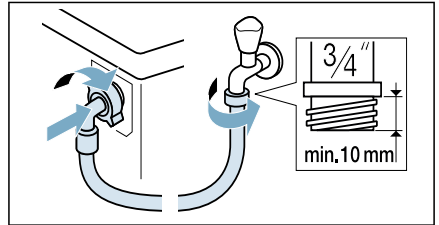

- Model: **Aqua-Secure**

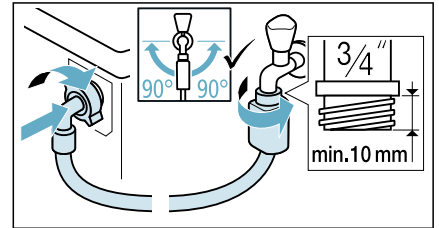

- Model: **Aqua-Stop**

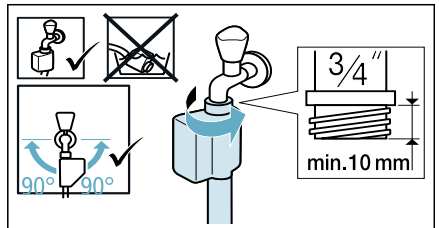

**Tip:** Connect also an external water filter (depending on the model) between water supply hose and tap. The filter filters dirt particles out of the water.

Water filter must be cleaned regularly to remove contaminants. This will prevent blockages. See also → separate installation and cleaning instruction for water filter.

- Open the water tap carefully, checking the leak tightness of the connection points. The screw connection is under mains water pressure.

## Water outlet

### **Warning** **Risk of scalding!**

When you are washing at high temperatures, there is a risk of scalding if you come into contact with hot water (e.g. when draining hot water into a washbasin).

Do not reach into the hot water.

### **Caution!** **Water damage**

When water is being pumped away, the outlet hose is under water pressure and may slip out of the wash basin or connection point.

Secure the drain hose so that it cannot slip out.

### **Caution!** **Damage to the appliance/fabrics**

If the end of the drain hose is immersed in the drained water, water may be sucked back into the appliance and may damage the appliance/fabrics. Make sure that:

- The plug does not block drainage from the washbasin.
- The end of the drain hose is not immersed in the drained water.
- The water drains away quickly enough.

**Note:** Do not kink the water drain hose or put strain on it lengthways.

## Connection

### ■ **Drainage into a siphon**

The connection point must be secured using a hose clamp with a diameter of 24 - 40 mm (available from specialist dealers).

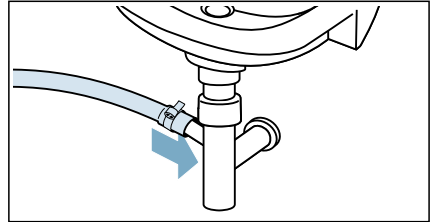

### ■ **Drainage into a washbasin**

Secure the outlet hose so that it cannot slip out.

Elbow available from after-sales service:

Individual part number 00655300

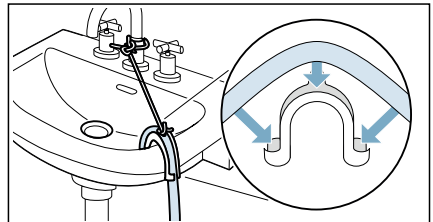

### ■ **Drainage into a plastic pipe with rubber bushing or into a drainage pit**

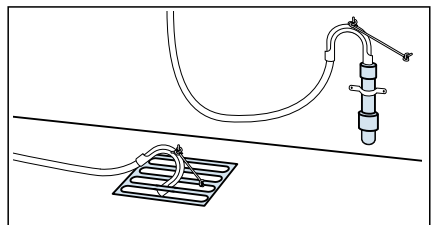

**Note:** The plastic pipe is not standard accessory, available from specialist dealers.

## Alignment

Level the appliance using a spirit level. Incorrect levelling may result in intense noise, vibrations and "wandering".

1. Loosen the lock nuts using a wrench, by turning it in a clockwise direction.

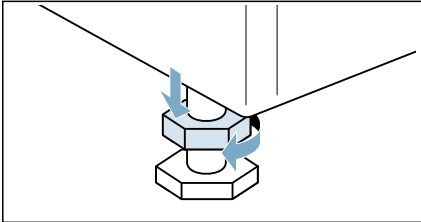

2. Check the alignment of the appliance with a spirit level, and adjust it if necessary. Change the height by turning the appliance feet. All four appliance feet must stand firmly on the ground.

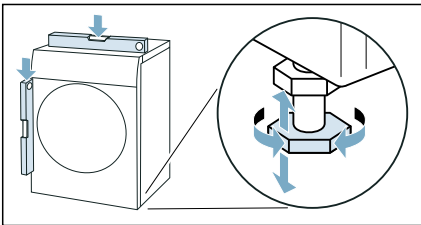

3. Tighten the lock nut against the housing. In doing so, hold the foot tight and do not adjust its height. The lock nuts on all four appliance feet must be screwed tightly against the housing.

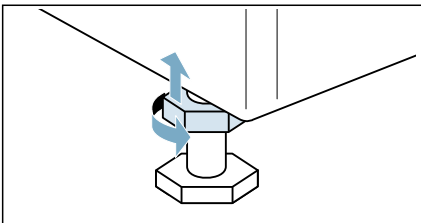

## Electrical connection

### **Warning** **Risk of death!**

There is a risk of electric shock if you touch live components.

- Never touch or hold the mains plug with wet hands.
- Only pull out the mains cable by the plug and never by the cable, as this could damage it.

Observe the following information and ensure that:

### Notes

- The mains voltage and voltage indicated on the appliance (rating plate) are the same. The connected load and fuse required are specified on the rating plate.
- The appliance is only connected to an alternating current via a properly installed earthed socket.
- The mains plug fits the socket.
- The earthing system is properly installed.
- The mains cable is only replaced by a qualified electrician (if this is necessary). Replacement mains cables are available from the after-sales service.
- No multiple plugs/couplings or extension cables are used.
- If an earth-leakage circuit breaker is used, only a type which displays this symbol is used: . Only this symbol guarantees compliance with the currently applicable regulations.
- The mains plug can be accessed at all times.
- The mains cable is not bent, squashed, modified, cut through, or in contact with heat sources.



## Before washing for the first time

The appliance was thoroughly tested before leaving the factory. To remove any water that may be left over from the test, run the first wash cycle **without** any laundry.

### Notes

- The appliance **must be correctly installed and connected**.
- Never use a damaged appliance. Inform customer services.

### Preparatory work:

1. Check the appliance.
2. Fill the dispenser  and .
3. Plug into the mains.
4. Turn on the tap.

### Run the programme without laundry.

1. Switch on the appliance.
  2. Close the door (do not load any laundry).
  3. Set the **Drum Clean** programme.
  4. Open the detergent drawer.
  5. Pour approx. 1 litre of water into the dispenser for manual dosing.
  6. Pour standard detergent into the dispenser for manual dosing.
- Note:** To prevent foaming, only use half of the amount of detergent recommended by the detergent manufacturer. Do not use detergents designed for woollens or delicates.
7. Close the detergent drawer.
  8. Start the programme.
  9. When the programme ends, press the  button till the indicator lamp turns off, release the button.

**Your appliance is now ready to use.**

## Transportation

e.g. when moving home

### Preparatory work:

1. Turn off the water tap.
2. Reduce the water pressure in the supply hose. → *Page 56*
3. Drain any residual water. → *Page 55*
4. Disconnect the appliance from the mains.
5. Remove the hoses.
6. Empty the dispensers. → *Page 53*

### Installing the transport locks:

1. Remove the covers and keep them in a safe place.

**Note:** Use a screwdriver if necessary.

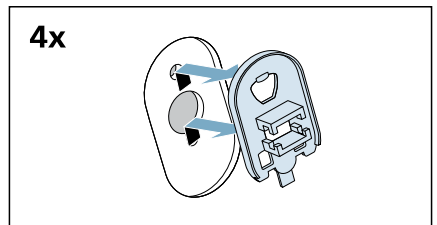
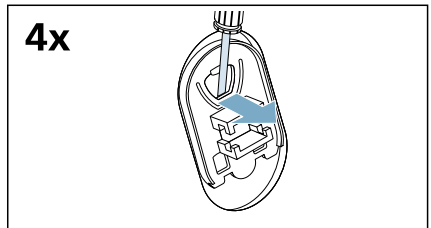

**en** Positioning and connecting

**2.** Insert all four sleeves.

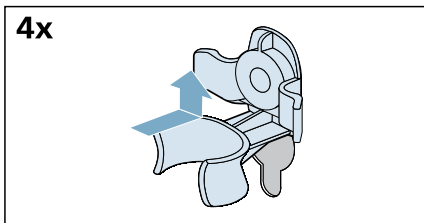

a) Clip the mains cable securely in the holders.

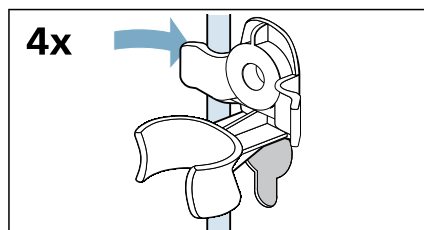

b) Insert and tighten the screws.

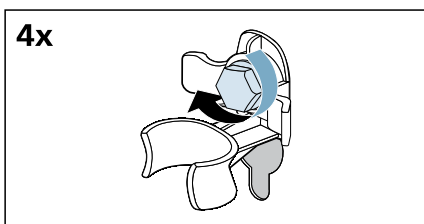

c) Clip the hoses securely in the holders.

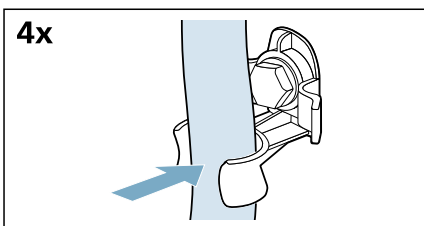

**Before switching on the appliance again:**





**Notes**

- The support struts **must** be removed.
- The transport braces **must** be removed.  
→ *"Removing the transport locks" on page 14*
- Pour approx. 1 litre of water into the dispenser for manual dosing, select the **Rinse, Spin** or **Drain** programme and start. This will prevent detergent from flowing straight into the drain during the next wash.

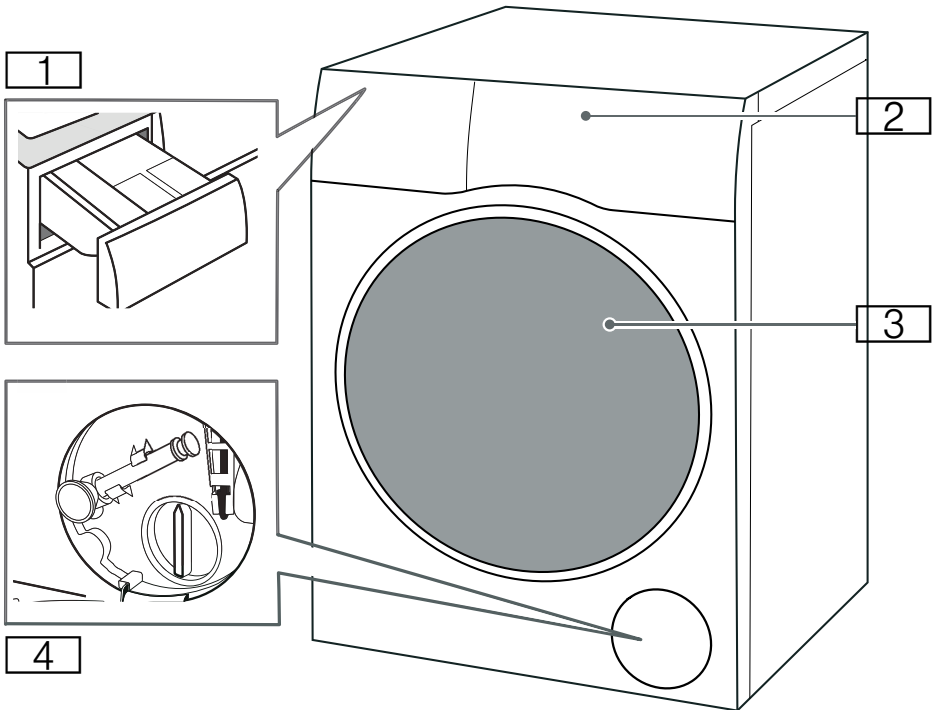
# Get to know your appliance

## Appliance



-  Detergent drawer with i-Dos reservoir
-  Control panel/touch display
-  Door
-  Service flap

en Get to know your appliance

## Control panel



- 1 Touch display**  
Touch lightly to select settings.
- 2 Door opening**  
Press to open the door.  
You will only be able to open the door if the appliance is switched on and the programme progress allows it.
- 3 Main switch**  
Press to switch the appliance on or off (standby).



## Touch display

### Caution!

#### Material damage/damage to the appliance.

Exerting excessive pressure on the display may damage it. Do not use a sharp object on the display or exert excessive pressure on it.

**Note:** If you touch the screen near the edge, the appliance may not detect this if you have touched it outside of the detection area.

### Operating logic

#### Touching

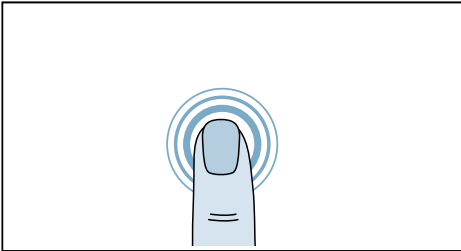

Touch the touch display with your finger to open or select an element.

#### Swiping

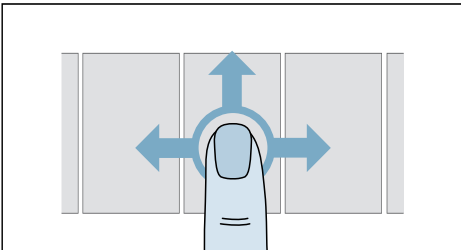

Swipe your finger over the touch display to scroll through a list, either from left to right or top to bottom.

### What the symbols mean



Setting is not selected



Setting selected



Return to the higher-level screen

### What the colours mean



Setting cannot be selected



Setting can be selected or has already been selected



Setting has been selected

## Menu

After switching on the appliance:

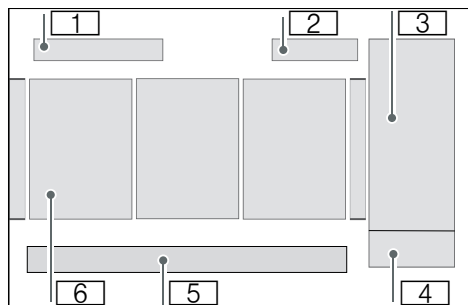

- 1 **Programmes or favourites**
- 2 **Time** → Page 34
- 3 **Options** → Page 30
- 4 **Start or Pause**
- 5 **Appliance menu** → Page 32
- 6 **Programmes**

After selecting a programme:

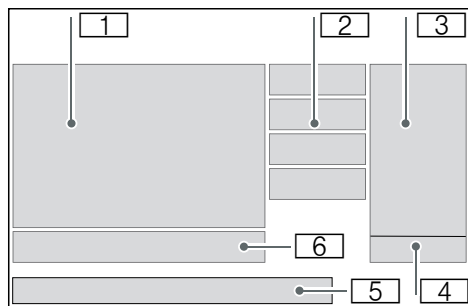

- 1 **Programme**
- 2 **Programme settings** → Page 26
- 3 **Options** → Page 30
- 4 **Start or Pause**
- 5 **Appliance menu** → Page 32
- 6 **Programme features** → Page 28

## Operating the appliance

### Switching on the appliance/ selecting a programme

**Note:** The appliance must be correctly installed and connected.

1. Switch on the appliance.

#### Notes

- It may take a few seconds for the appliance to switch on.
- If you are switching the appliance on for the first time, you will need to select the language you require (you will not need to do this every time). → Page 35

2. Scroll through the options to find the programme you require.

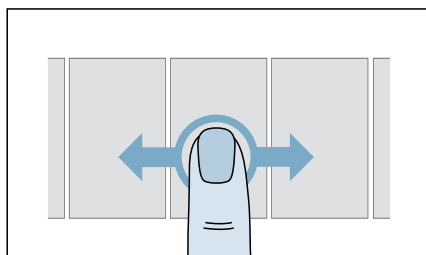

**Note:** If you have saved programmes as favourites, switch to **Favourites** and select the programme you require from there. → Page 29

3. Touch the required programme.

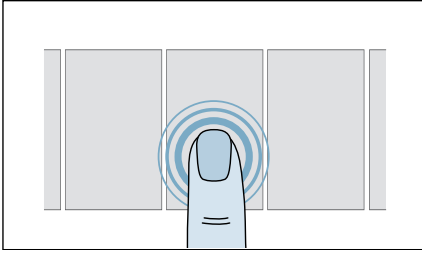

Your programme has now been selected and the associated **programme settings** and **programme features** will be displayed.

**Note:** If the childproof lock has been activated, you may need to deactivate it before you can make any changes on the touch display or start the programme. → *Page 32*

### Putting the washing in the drum

1. Prepare and sort the laundry.
2. Press  to open the door and check whether the drum has been completely emptied. If required, empty the drum.

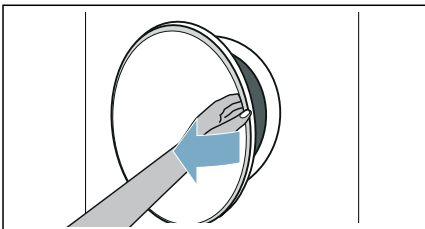

#### Notes

- You can only open the door if the appliance is switched on.
- If the door will not open (e.g. due to a power cut), you can open the door manually. → *Page 57*

3. Load the laundry unfolded into the drum.

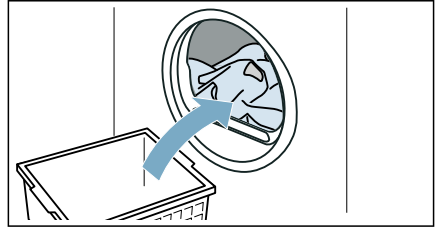

4. Close the door.

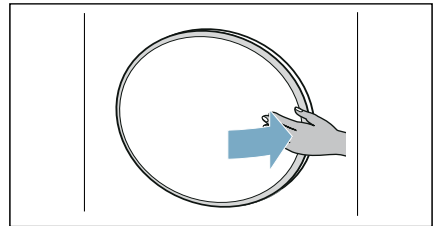

#### Caution!

**Exerting excessive pressure on the door may damage it.**

Do not apply a high amount of pressure on the door.

#### Caution!

**Risk of material damage to the appliance or laundry.**

Make sure that laundry is not trapped in the door.

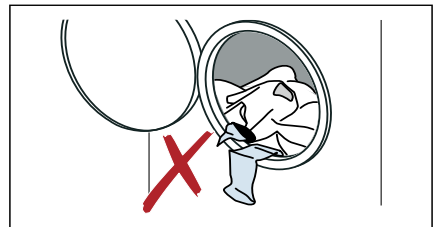

## Programme settings

Once you have selected a programme, you will be shown preset programme settings. Preset programme settings are recommendations for the programme you have selected and will vary.

You can find further programme settings by touching **+** **More**.

### You can do the following to programme settings:

- Adjust them
- Activate/deactivate them

### Adjusting

1. Touch the programme setting.

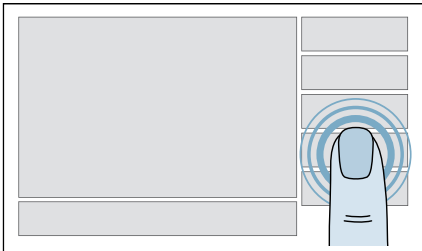

The setting options will be displayed.

2. Touch or swipe your finger along the bar until the required value is selected.

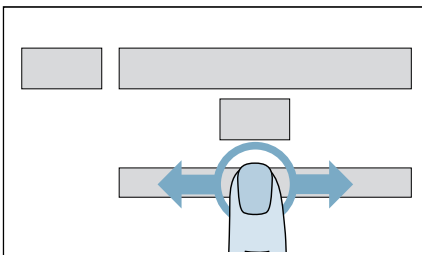

### Notes

- The changes will be applied immediately and do not need to be confirmed.
- The changes will not be saved permanently for the programme.

3. Touch the programme setting to return to the programme settings overview.

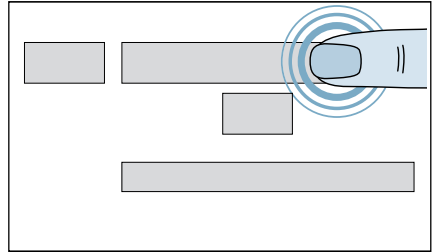

### Activating/deactivating

1. Touch the programme setting.
2. Touch the programme setting to activate or deactivate it.

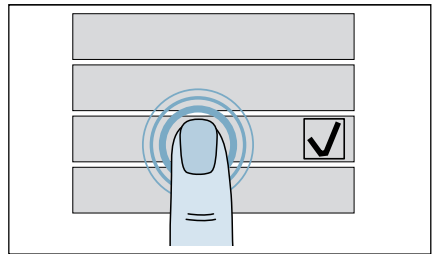

If a tick appears, this means that the programme setting has been activated. If there is no tick, this means that the programme setting is deactivated.

### Notes

- Touch ← to return to the higher-level screen.
- Not all programme settings are available for every programme.
- Once you have started a programme, depending on how far through the programme the appliance is, it may not still be possible to select certain programme settings.

## **Temperature**

Before and after the programme starts, you can change the set temperature depending on how far through the programme the appliance is.

The maximum temperature that can be set depends on the programme that has been selected.

Touch  **Temperature** and adjust it.

## **Spin**

Before and after the programme starts, you can change the spin speed (in rpm; revolutions per minute) depending on how far through the programme the appliance is.

The maximum speed that can be set depends on the model and programme that has been selected.

Touch  **Spin** and adjust it.

## **Extra Rinse**

Additional rinse cycle for particularly sensitive skin and/or for areas with very soft water.

Touch  **Extra Rinse** and adjust it.

**Note:** Additional rinse cycles extend the duration of the programme.

## **Prewash**

Prewash for heavily soiled laundry.

Touch  **Prewash** to activate or deactivate it.

## **Less Ironing**

Reduces creasing by means of a special spin sequence followed by fluffing and reduced spin speed.

Touch  **Less Ironing** and activate or deactivate it.

**Note:** If  **Less Ironing** has been activated, the laundry will have retained a higher than average level of moisture after spinning.

## **Water Plus**

Increased water level for gentler treatment of the laundry.

Touch  **Water Plus** to activate or deactivate it.

## **Silent Wash**

Reduced noise values thanks to a special wash and spin cycle and deactivated end signal. Especially suitable for washing at night.

Touch  **Silent Wash** to activate or deactivate it.

## **Soaking**

Before the main wash cycle starts, the laundry remains in the water for longer to remove bad soiling. To be used for particularly stubborn soiling.

Touch  **Soaking** and adjust it.

**Note:** To avoid discolouration, only soak laundry of the same colour together.

## **Rinse Hold**

The laundry remains in the rinsing water after it has been washed.

Touch  **Rinse Hold** and activate or deactivate it.

**Note:** If you have selected  **Rinse Hold**, the laundry remains in the rinsing water after it has been washed. You either have to spin the laundry or drain the water in order to end the programme. Only then can you remove the laundry.

## **Stains**

Adjusts the washing temperature, drum movement and soaking time to the specific type of stain.

Hot or cold water, gentle or intensive washing and long or short soaking ensure that the wash programme

## en Operating the appliance

sequence is specially adapted to each type of stain.

Touch  **Stains** and select the appropriate type of stain.

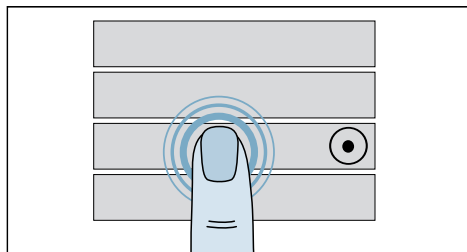

**Note:** The programme duration, number of rinse cycles and water level may vary, depending on the type of stain selected.

### Programme features

Once you have selected a programme, look at the programme features.

Touch the required feature.

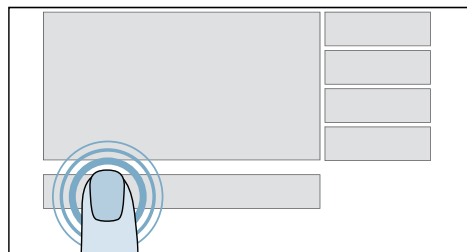

#### Delayed start

Before the programme starts, you can set the time at which you want the programme to finish.

1. Touch .
2. Slide your finger along the bar until the required number of hours and minutes are shown/the time at which you want the programme to end is shown.

**Note:** Once you have set the time on your appliance, you can set the time at which you want the programme to end.

If you have not set the time, you will only be able to set when the programme ends in hours and 30 minute increments.

3. Touch .

The programme end has now been set and your programme will start after a delay.

**Note:** As long as the programme has not yet started, you will still be able to load more laundry or remove some from the drum.

#### Flex start

Activate the **Flex start** function to allow your smart energy system (Energy manager) to start your appliance once your home photovoltaic system is able to provide sufficient energy or the energy tariff is good.

**Note:** Your smart energy system (Energy manager) cannot start your appliance until it is connected to the appliance.

#### Activating Flex start

1. Touch .
2. Slide your finger along the bar until the required time period is shown in hours or as a clock time.

**Note:** Once you have set the time on your appliance, you can use this to set the time period.

If you have not set the time or if you have deactivated it, you will only be able to set the time period in hours.

3. Touch .
4. Touch .



The **Flex start** function has now been activated and the appliance will wait to be started by the smart energy system (Energy manager).

## Notes

- If the smart energy system (Energy manager) does not start the appliance, the programme will still be started before the set time period ends.  
The programme will then end when the time period ends.
- To prevent the build-up of odours, the appliance is always started with **Flex start** such that the laundry never remains in the drum for more than 6 hours after the programme has ended.
- Any action on the appliance (such as adjusting the programme selector) will deactivate **Remote start** and in turn the **Flex start** function.  
If the **Flex start** function is deactivated by an action being performed on the appliance, the  **Delayed start** will remain active.

## Adding more laundry or removing laundry

If the **Flex start** function has already been activated but the programme has not yet started, you will still be able to load more laundry or remove some from the drum.

1. Touch .
2. Open the door.
3. Add more laundry or remove laundry.
4. Close the door.
5. Touch .
6. Touch .

**Flex start** will appear on the display panel.



The **Flex start** function has now been activated and the appliance will wait to be started by the smart energy system (Energy manager).



You can display useful information and the energy and water consumption for each programme.

Compare the consumption data for each of the programmes with the

options and programme settings that have been selected for them, so that you can reduce your energy and water consumption.

1. Touch .
- This displays the energy and water consumption and the programme information.
2. Touch  to return to the programmes overview.

## ☆ Favourites

You can manage a selected programme with your favourite settings.

### You can do the following to favourites:

- Save them
- Call them up
- Delete them

## Saving

1. Select the programme you require, and adjust the programme settings as needed.
2. Touch  in the programme features.  
This programme has now been saved to your list of favourites.

## Notes

- Each programme can only be saved once.
- You can save up to seven favourite programmes.

## Calling up

1. Switch on the appliance.
2. Touch  **Favourites**.
3. Touch the favourite programme you wish to use.
4. Start the programme.

## Deleting

1. Select the favourite programme you want to delete.
2. Touch  in the programme features.
3. Confirm that you wish to delete this favourite programme.  
This programme has now been deleted from your list of favourites.



## Options

After you have set a programme, you can use the options to further customise the washing process to your laundry.

### You can do the following to options:

- Adjust them
- Activate/deactivate them

### Adjust them

1. Touch the option.

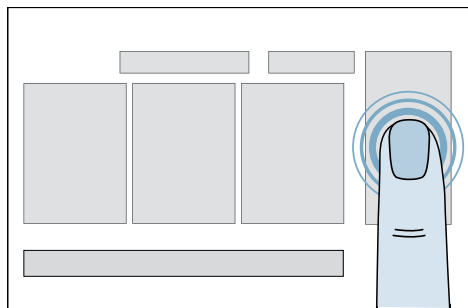

2. The setting options are displayed.
2. Touch or swipe your finger along the bar until the required value is displayed.

**Note:** The changes are applied immediately and do not need to be confirmed.

### Activating/deactivating



1. Touch the option.
2. Touch the option to activate or deactivate it.

### Remote start

Activate remote start to allow the appliance to be started via the Home Connect app.

Touch it briefly to activate or deactivate it.

## Notes

- The appliance must be connected to your home network to activate remote start.
- Remote start can only be activated if the appliance door and detergent drawer are closed.
- Remote start cannot be activated if the childproof lock is active. Deactivate the childproof lock beforehand.
- Remote start will be deactivated for safety reasons in the following circumstances:
  - If you open the door.
  - In the event of a power failure.
  - Once the programme has ended.
  - If you press  on the appliance.
  - If you press **Remote start**  again on the appliance.
  - If you press  for standby mode.

## i-Dos

Adjust the dosage of the intelligent dosing system. (i-Dos Auto Dosing)

Depending on how dirty your laundry is, choose the most suitable liquid detergent dosage before the programme starts.

Depending on how soft you want your laundry to be, choose the most suitable softener dosage.

1. Touch the button for the reservoir you require.

**Note:** You can pour either softener or liquid detergent into the left-hand i-Dos reservoir. → *Page 35*
2. Touch or swipe your finger along the bar until the required value is displayed.

**Detergent dosage**

- 3** High dosage for particularly dirty laundry
- 2** Medium dosage for moderately dirty laundry
- 1** Low dosage for laundry that is not very dirty
- Off** i-Dos Auto Dosing deactivated

**Softener dosage**

- 3** High dosage for very soft laundry
- 2** Medium dosage for moderately soft laundry
- 1** Low dosage for slightly soft laundry
- Off** i-Dos Auto Dosing deactivated

**Notes**

- The changes will be applied immediately and do not need to be confirmed.
- Putting the appliance in standby mode will not undo these changes.

**varioSpeed** 

This programme uses extra energy to wash your laundry more quickly.

Touch **varioSpeed**  to activate or deactivate this option.

**Note:** With the **varioSpeed**  option activated, your laundry will still be washed just as effectively by your chosen programme as when this option is not selected.

**eco** 

This programme washes at lower temperatures over a longer period of time to conserve energy.

Touch **eco**  to activate or deactivate this option.

**Note:** With the **eco**  option activated, your laundry will still be washed just as effectively by your chosen programme as when this option is not selected.

**Start the programme**



Touch and hold  button for 1~2 seconds, then release the button.

The programme starts and the appliance door is locked.

The programme information is shown on the touch display while the programme is in progress.

**Adding more laundry or removing laundry**

If the programme has already started, you will still be able to load more laundry or remove some from the drum.

1. Touch . This will pause the programme.
2. Open the door.
3. Add more laundry or remove laundry.
4. Close the door.
5. Touch .

**Notes**

- Do not leave the appliance door open for too long when adding more laundry, otherwise water may start to trickle out from the laundry.
- For safety reasons, the appliance door remains locked when the water level or temperature is high, during the active oxygen treatment (depending on appliance features) and while the drum is turning, and it is not possible to add more laundry during this time. Refer to the messages on the touch display.

## Cancel the programme

1. Touch **Cancel**.
2. Press  $\cong$  to open the door.  
**Note:** If there is a high water level or high temperature, the appliance door remains locked for safety reasons.
3. Remove the laundry.

### If the temperature is too high:

1. Touch **Cancel**.
2. Select the **Rinse** programme to cool the laundry.
3. Touch  $\triangleright$ .

### If the water level is too high:

1. Touch **Cancel**.
2. Select the **Spin** or **Drain** programme to drain the water.
3. Touch  $\triangleright$ .

## Programme end

**Laundry is ready.** will appear on the touch display

1. Press  $\cong$  to open the door.
2. Remove the laundry.
3. Press  $\odot$  for standby mode.

**Note:** If you have selected  $\cup$  **Rinse Hold**, the laundry will remain in the rinsing water after it has been washed. You must either spin the laundry or drain the water in order to end the programme. Only then can you remove the laundry.

## Appliance menu

In the appliance menu, you can activate/deactivate the childproof lock and signal tones, and implement all appliance settings.

1. Touch  $\wedge$  or touch and swipe upwards.

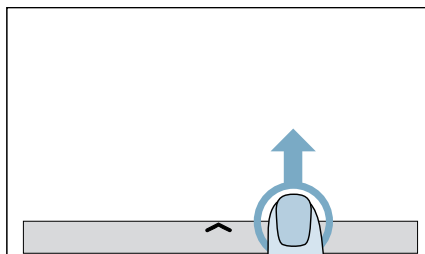

- The appliance menu is now open.
2. Touch the required setting.

## Childproof lock

You can lock the control panel to prevent settings from being changed inadvertently.

### You can do the following to the childproof lock:

- Activate
- Deactivate

#### Activating

Touch .

This activates the childproof lock; you will no longer be able to make any changes on the touch display.

#### Deactivate

1. Touch anywhere on the touch display.  
A message appears on the touch display to tell you that the childproof lock has been activated.
2. Touch and hold **Deactivate child lock** for three seconds.  
This deactivates the childproof lock.

**Notes**

- To remove the laundry at the end of the programme, deactivate the childproof lock.
- The childproof lock can be activated no matter what status the appliance is in.
- The childproof lock also remains activated when the appliance has been put into standby mode.
- If the appliance is put into standby mode while the programme is running and the childproof lock has been activated, the programme resumes when the appliance is switched back on.

**Audible signal settings** 🔊

Signal tone after the end of the programme.

**You can do the following to the signal tone:**

- Deactivate it
- Activate it

**Deactivating**

Touch 🔊).

**Activating**

Touch 🔊).

**Appliance Setting** ⚙️**You can do the following to appliance settings:**

- Adjust them
- Activate/deactivate them

**Adjusting**

1. Touch ⚙️.
2. Swipe until the required appliance setting appears.

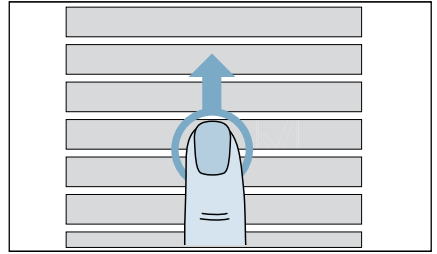

3. Touch the appliance setting.

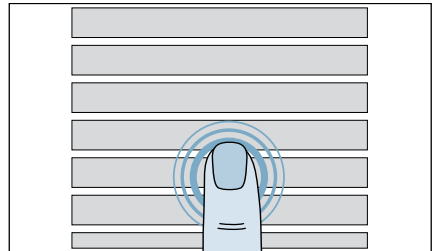

4. Touch or swipe your finger along the bar until the required value is displayed.

**Note:** The changes are applied immediately and do not need to be confirmed.

### Activating/deactivating

1. Touch the appliance setting.
2. Touch the appliance setting to activate or deactivate it.

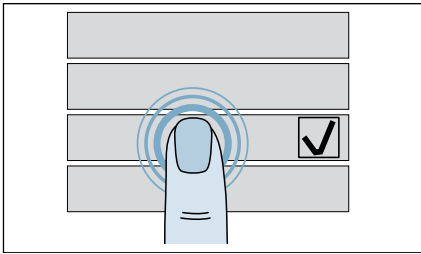

If a tick appears, this means the setting has been activated. If there is no tick, this means that the setting is deactivated.

### Time

You can set the time on the appliance.

1. Touch **Time**.
2. Touch **On**.
3. Touch the hour side of the time display and swipe your finger along the bar until the correct hour is shown.

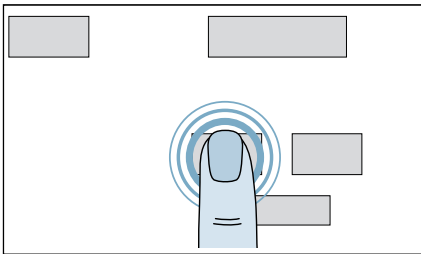

4. Touch the minutes side of the time display and swipe your finger along the bar until the correct number of minutes past the hour is shown.

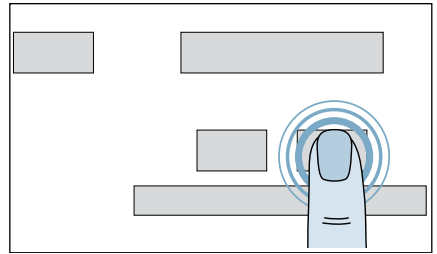

The time has now been set.

**Note:** The time will only be shown on the touch display if it has been activated.

### Sounds

You can set the tones for the buttons, messages and the programme end.

1. Touch **Sounds**.
2. Choose between **Programme End** and **Buttons and Info**.
3. Swipe your finger along the bar until the required volume is selected.

### Drum clean reminder

Your appliance can issue you with regular reminders to run the cleaning programme.

Touch **Drum clean reminder** to activate or deactivate the reminder function.

### Brightness

You can set the brightness of the touch display.

Touch **Brightness** and adjust it.

## Light Ring

You can define when the door light lights up or set the brightness of the door light.

1. Touch **Light Ring**.
2. Touch **Set Brightness** to adjust the brightness.
3. Touch **Set Mode** to define whether the door light should be activated or deactivated or whether it should only deactivate for specific situation.

## i-Dos Auto Dosing



You can adjust the basic dosage for your i-Dos reservoir.

1. Touch **i-Dos Auto Dosing**.
2. Touch **Left-hand side dispenser** or **Right-hand side dispenser**.
3. Swipe the bar to adjust the dosage in 10 ml increments, and touch **+** or **-** to adjust the dosage in 1 ml increments.

**Note:** If you make changes to the i-Dos settings, the settings you were previously using will be overwritten. This also applies to programmes that you have saved under **Favourites**.

## Changing the i-Dos compartment from softener to liquid detergent

You can pour either softener or liquid detergent into the left-hand i-Dos compartment.

1. Touch **i-Dos Auto Dosing**.
2. Touch **Left-hand side dispenser**.
3. Touch  to set the compartment for softener, or  to set the compartment for liquid detergent.

**Note:** If you make changes to the i-Dos settings, the settings you were previously using will be overwritten. This also applies to programmes that you have saved under **Favourites**.

## Language

You can set the language.

1. Touch **Language**.
2. Scroll through the list until the language you require is shown.

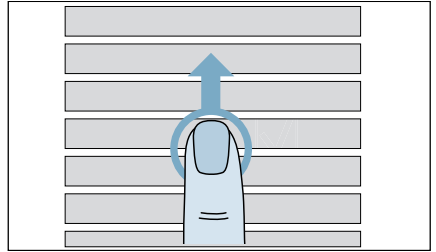

3. Touch the required language.

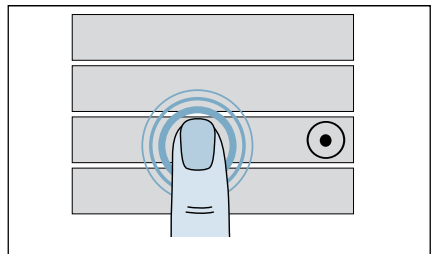

4. Touch **Restart** to apply the change.

**Note:** If you change the language, this change will not be applied until the appliance is restarted.

## Home Connect

You can find all the information regarding Home Connect in the dedicated section. .

### Software update is available. Would you like to install update?

As soon as a new update is available, a message will appear on the touch display on your appliance.

You can install the update directly via the message on the display or, alternatively, via the appliance settings.

Touch **Software update is available. Would you like to install update?**. The update will now be installed. Installation may take a few minutes.

#### Notes

- Do not put the appliance in standby mode while it updates.
- If no software updates are available, Your software is up to date. will appear on the touch display.

### Factory settings

You can reset all your appliance settings.

1. Touch **Factory settings**.
2. Touch **Reset**.
3. Confirm that you wish to reset the settings.

**Note:** If you do this, your saved favourite programmes will be lost.

## Home Connect

This appliance is Wi-Fi-capable and can be remotely controlled using a mobile device.

You can use the Home Connect app to do the following on your appliance from your mobile device:

- Set up programs and launch them.
- Adjust, activate and deactivate program settings.
- Query the status of programs.
- Adjust, activate and deactivate appliance settings.
- Put the appliance into standby mode.

Before you can use the Home Connect functions, you will need to carry out the following steps:

1. Install the Home Connect app on your mobile device.
2. Register in the Home Connect app.
3. Connect your appliance to your home network automatically **or** manually (you only need to do this the first time).
4. Connect your appliance to the Home Connect app.

You can find information about the app on our Home Connect website [www.home-connect.com](http://www.home-connect.com).

Home Connect services are not available in every country. The availability of the Home Connect function depends on the availability of Home Connect services in your country. You can find information on this at [www.home-connect.com](http://www.home-connect.com).





## Notes

- Please observe the safety precautions in this instruction manual and make sure that these are complied with even when operating the appliance via the Home Connect app while you are away from home. You must also follow the instructions in the Home Connect app.
- You cannot use the Home Connect app to make changes while the controls on the appliance are being operated. However, you can use the Home Connect app to see any adjustments made directly on the appliance itself.

## Calling up the Home Connect menu

In the Home Connect menu, you can create and view network connections, reset network settings, activate/deactivate Wi-Fi and find other Home Connect functions.

1. Switch on the appliance.
2. Press  or press and hold  and swipe upwards.

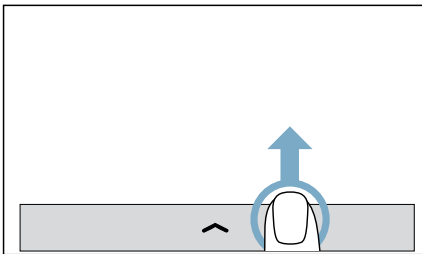

A menu is displayed.

3. Press .
4. Press **Home Connect**.
5. Press **Continue**.

You are now in the Home Connect menu.

**Note:** Press  to return to the higher-level screen.

## Connecting to the home network and the Home Connect app

Connect your appliance to the home network **automatically** or **manually** (you only need to do this the first time).

### Notes

- If your home network router has a WPS function, you can connect the appliance to your home network automatically.
- If your home network router does not have a WPS function, you need to connect the appliance to your home network manually.

You must then connect to the Home Connect app.

**Note:** To connect your appliance to the home network, **Wi-Fi** must be activated on the appliance. **Wi-Fi** is deactivated on the appliance by default and is activated automatically when you connect your appliance to your home network.

## Connecting to your home network automatically

### Step 2.1

Ensure that you are in the Home Connect menu. → *Page 37*

1. Press **Settings**.
2. Press **Connect to network**.
3. Press **Connect automatically (WPS)**.

4. Confirm the message in the display. The appliance now attempts to connect to your home network.  flashes in the display.

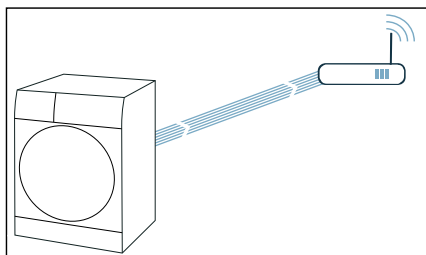

5. Activate the WPS function on your home network router within the next 2 minutes.
6. Confirm the message in the display. If the appliance has connected to your home network successfully, **Your home appliance is connected to yourhome network.** and  appear in the display and light up continuously.

**Note:** If you are not able to establish a connection, check whether your appliance is within range of your home network. Try connecting automatically again or connect your appliance manually.

## Connecting to your home network manually

### Step 2.2

Ensure that you are in the Home Connect menu. → *Page 37*

1. Press **Settings**.
2. Press **Connect to network**.

3. Press **Connect manually**. The appliance now sets up its own Wi-Fi network with the name (SSID) **HomeConnect**.

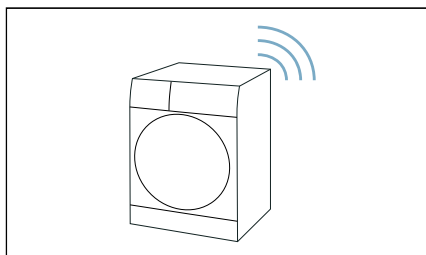

4. Call up the Wi-Fi setting on the mobile device.
5. Connect the mobile device to the **Home Connect** Wi-Fi network and enter the password (key) **HomeConnect**. Your mobile device now connects to the appliance. The connection process may take up to 60 seconds.

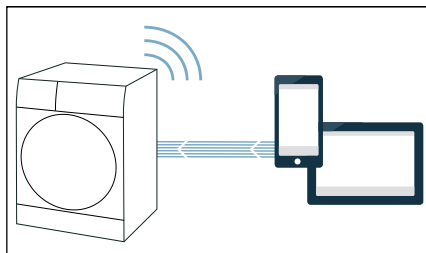

6. Confirm the message in the display.
7. Once you have connected successfully, open the Home Connect app on the mobile device.
8. In the Home Connect app, enter the network name (SSID) and password (key) for **your home network**.
9. Carry out the last steps in the Home Connect app to connect your appliance.
10. Confirm the message in the display. If the appliance has connected to your home network successfully, **Your home appliance is connected to yourhome network.** and  appear in the display and light up continuously.

**Note:** If you are not able to establish a connection, check whether your appliance is within range of your home network. Try connecting manually again.

## Connecting to the Home Connect app

### Step 3

If your appliance is connected to your home network, you can connect it to the Home Connect app.

Ensure that you are in the Home Connect menu. → *Page 37*

Make sure that you have opened the Home Connect app and are logged in.

1. Press **Settings**.
2. Press **Connect with app**.  
The appliance now attempts to connect to the Home Connect app.
3. Once your appliance is displayed in the app, carry out the last steps in the Home Connect app.
4. Confirm the message in the display.

**Note:** If you were not able to establish a connection, check whether your mobile end device is within range of your home network or is connected to this. Try connecting to the Home Connect app again.

## Energy management

You can connect your appliance to your smart energy system (Energy manager).

Once you have connected your appliance to the smart energy system (Energy manager) and activated the **Flex start** function, you will be able to optimise your energy consumption because your appliance will not start up until your home photovoltaic system can provide sufficient energy or the energy tariff is good.

Further information and system requirements for using the Energy manager can be found at: **[www.home-connect.com/energymanagement](http://www.home-connect.com/energymanagement)**

## Notes

- The smart energy system (Energy manager) must use the EEBus initiative communications standard.
- Before you start, read the smart energy system instruction manual to find out how to connect your appliance to the smart energy system (Energy manager).

1. Press .
2. Press **Connect with energy manager**.  
Your appliance now attempts to connect to the smart energy system (energy manager). If the appliance has connected successfully, **Your home appliance is connected to your energy manager** appears in the display.
3. Press **Continue**.
4. Activate Flexstart if you want the smart energy system (Energy manager) to start up your appliance.

## Status

View the status of your connection to the home network, to the app and to the energy manager (depending on the appliance features).

Ensure that you are in the Home Connect menu. → *Page 37*

Press **Status**.

## Activating/deactivating Wi-Fi

If your appliance is already connected to your home network, you can activate or deactivate **Wi-Fi** on your appliance.

Ensure that you are in the Home Connect menu. → *Page 37*

Press **Wi-Fi**.

## Notes

- If you connect to your home network, Wi-Fi is activated automatically.
- If Wi-Fi is activated on your appliance, the appliance is not automatically put in standby mode.
- If Wi-Fi is switched off on the appliance, it is not possible to use the Home Connect app to start or control the appliance remotely.
- If Wi-Fi is switched off and your appliance was previously connected to your home network, this connection will be re-established automatically when Wi-Fi is switched back on.
- If you activate this function, the energy consumption increases in comparison to the values specified in the consumption value table.

## Resetting your network settings

You can reset all of the network settings.

Ensure that you are in the Home Connect menu. → *Page 37*

1. Press **Reset**.  
**Do you want to reset all network settings?** appears in the display.
2. Press **Factory settings**.

**Note:** If you want to operate your appliance via the Home Connect app again, you will need to reconnect it to your home network and to the Home Connect app.

## Updating the software

You can update the Home Connect software on your appliance. As soon as a new software update is available, a note appears in the display: **Software update is available. Would you like to install update?**

Install the update directly via the **message in the display** or **manually** as follows:

1. Press .
2. Press **Software Update**.  
The Home Connect software will now be updated.
3. Confirm the message in the display.

**Note:** If no software update is available, **Your software is up to date** appears in the display.

**Note:** The software update may take several minutes. Do not switch the appliance off while updates are being installed.

## Information on data protection

When your appliance is connected for the first time to a Wi-Fi network, which is connected to the Internet, your appliance transmits the following categories of data to the Home Connect server (initial registration):

- Unique appliance identification (consisting of appliance codes as well as the MAC address of the installed Wi-Fi communication module).
- Security certificate of the Wi-Fi communication module (to ensure a secure data connection).
- The current software and hardware version of your household appliance.
- Status of any previous resetting to factory settings.

This initial registration prepares the Home Connect functions for use and is only required when you want to use these Home Connect functions for the first time.

**Note:** Ensure that the Home Connect functions can be used only in conjunction with the Home Connect app. Information on data protection can be accessed in the Home Connect app.

## Declaration of Conformity

BSH Hausgeräte GmbH hereby declares that the appliance with Home Connect functionality meets the basic requirements and other relevant provisions of the Directive 2014/53/EU.

A detailed RED Declaration of Conformity can be found online at [www.siemens-home.bsh-group.com](http://www.siemens-home.bsh-group.com) among the additional documents on the product page for your appliance.





2.4 GHz band: max. 100 mW

## **i-DOS** Intelligent dosing system



### Intelligent dosing system in the detergent drawer

#### **i-Dos** Intelligent **Dosing** system

Your appliance has an intelligent dosing system for liquid detergent and fabric softener.

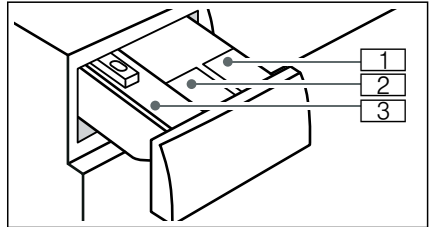
The i-Dos dispensers  and  in the detergent drawer are available for this purpose. You can select whether you want to use one liquid detergent and one softener or two liquid detergents. You can change the i-Dos dispenser from softener to liquid detergent. → *Page 35*



- 1 Dispenser  (1.3 l) for liquid detergent
- 2 Dispenser  (0.5 l) for fabric softener or liquid detergent
- 3 Dispenser for manual dosing

Depending on the selected programme and settings, the optimum quantity of detergent and/or fabric softener is dosed by the i-Dos dispensers.

### Initial use/filling the dispensers

Refer to the manufacturer's instructions when choosing your detergent and fabric softener. We recommend the use of standard, universal and colour liquid detergents for all appliance-washable, coloured fabrics made of cotton or synthetic materials.



#### Notes

- Only use easy-pour liquid products that the manufacturer recommends adding to the detergent drawer.
- Do not mix different liquid detergents. If changing your liquid detergent (type, manufacturer, etc.), empty the dispenser completely and clean it.

- Do not use products containing solvents, caustic agents or volatile substances (e.g. bleach).
- Do not mix detergent and fabric softener.
- Do not use products that have expired or are highly congealed.
- To prevent drying out, do not leave the dispenser lids open for a long period of time.

### Filling the dispensers:

The lids of the dispensers in the detergent drawer are marked with the following symbols:

-  Standard/universal liquid detergent
-  Fabric softener or liquid detergent

1. Open the detergent drawer.
2. Open the dispenser lid(s).

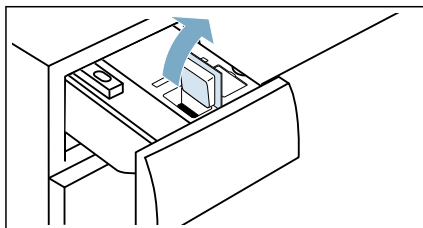

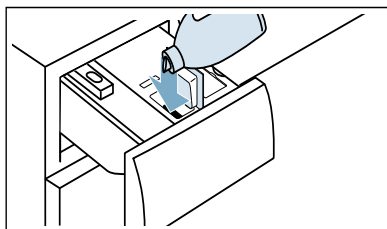

3. Add liquid detergent and/or fabric softener. Do not fill above the **max** marking.



4. Close the dispenser lid(s).
5. Slowly push the detergent drawer in completely.



## Everyday use

The intelligent dosages for detergent and fabric softener are set at the factory for all programmes in which intelligent dosing can be used.

The dosage strength has been preset to **Low** for liquid detergent  and to **Medium** for fabric softener . It can be changed individually for each programme. → Page 30

In addition to intelligent dosing, washing additives (e.g. stain remover) can be added manually via the dispenser for manual dosing.

### You can do the following settings:

- Activate/deactivate automatic dosing for / and adjust dosage strength. → Page 30
- Adjust the basic dosages of i-Dos dispenser. → Page 35

### Notes

- Reduce the basic dosage if using a very concentrated detergent.
- If large amounts of foam are repeatedly created during washing, please check your basic dosage and dosage strength settings. Certain types of liquid detergent can also create excessive amounts of foam. If your basic dosage and dosage strength settings are correct, we advise you to use a different detergent.
- The changes will be retained even when the appliance is switched off.

If the fill level for the dispenser is below the minimum level when intelligent dosing has been selected, you will get the message on the touch display.

**Note:** If you don't want to use i-Dos dispensers any more, and avoid you get this message again and again, you can set intelligent dosage to "Off" by touching **i-Dos**  button. → Page 30

The same liquid detergent or fabric softener can be added at any time. If you change product/manufacturer, we recommend that you clean the dispensers first.

If required, adjust the basic dosage.  
→ Page 35

## Manual dosage

For programmes that cannot be used with intelligent dosage, or if you would prefer to dose manually (in which case set intelligent dosage to "Off"), add liquid detergent to the dispenser for manual dosing.

Cleaning aids such as water softener, bleach and stain remover can be added to this dispenser in addition to the intelligent dosage.

### **Warning** **Eye/skin irritation!**

Detergent and care products may spray out if the detergent drawer is opened while the appliance is in operation. Open the drawer carefully.

Rinse eyes or skin thoroughly if they come into contact with detergent/care products. If swallowed accidentally, seek medical advice.

### **Caution!** **Damage to the appliance**

Cleaning agents and agents for pretreating laundry (e.g. stain removers, prewash sprays, etc.) may cause damage if they come into contact with the surfaces of the appliance.

Do not allow these agents to come into contact with the surfaces of the appliance. If necessary, immediately wipe away spray residue and other residues/droplets with a damp cloth.

## Notes

- When dosing all liquid detergents, cleaning aids and cleaning agents, always follow the manufacturer's instructions.
- If dosing liquid detergent manually, do not add additional liquid detergent to the intelligent dosage dispenser (set intelligent dosage to "Off"). This will prevent overdosing and foaming.
- Dilute viscous fabric softener and fabric conditioner with water to prevent blockages.

## Dosing and adding detergent:

1. Pull out the detergent drawer.

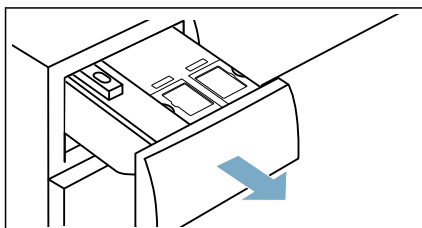

2. Add the correct dosage into the manual dosing dispenser depending on:
  - Soiling
  - Water hardness (ask your water supply company)
  - The amount of laundry
  - The manufacturer's instructions

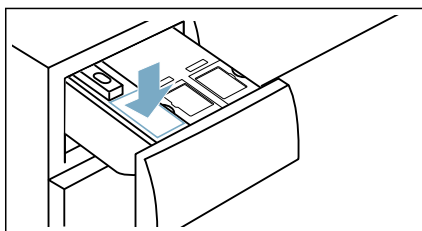

3. Close the detergent drawer.



## Laundry

### Protecting your laundry and appliance

#### Caution!

#### Damage to the appliance/textiles





Foreign objects (e.g. coins, paper clips, needles, nails) may damage the washing or components of the appliance.

The following instructions must be observed when preparing your laundry:

- Always follow the manufacturer's instructions when dosing all detergents, cleaning aids, care products and cleaning agents.
- Do not exceed maximum load. Overfilling will impair the washing result.
- Keep detergents and agents for the pretreatment of laundry (e.g. stain remover, prewash sprays, etc.) away from the surfaces of the appliance. Using a damp cloth, immediately remove any fine spray residue and other residue or droplets.
- Empty any pockets. Remove any foreign objects.
- Remove metal parts (paper clips, etc.).
- Trousers, knitwear and knitted textiles, e.g. jersey garments, T-shirts or sweatshirts, should be turned inside out.
- Ensure that underwired bras are appliance-washable.
- Wash delicates in a net or bag (tights, underwired bras, etc.).
- Close zips, button up covers.
- Brush sand out of pockets and collars.
- Remove curtain fittings or place in a net/bag.

### Sorting laundry

Sort your laundry according to the care instructions and manufacturer's information on the care labels, depending on:

- Type of fabric/fibre
- Colour
  - Note:** Laundry may discolour. Wash white and coloured items separately. Wash new coloured items separately the first time you wash them.
- Soiling
  - Wash laundry with the same level of soiling together. Some examples of soiling levels can be found in the chapter
    - **Light:** Do not need to pretreat, select the **varioSpeed** setting if necessary.
    - **Normal**
    - **Heavy:** Load less laundry, need to pretreat or soak laundry firstly.
    - **Stains:** Remove/pretreat stains while they are fresh. First dab with soapy water; do not rub. Then wash the items of laundry with the appropriate programme. Stubborn or dried-in stains can sometimes only be removed by washing several times.
- Symbols on the care labels
  -  Suitable for normal washing process; e.g. Cottons programme
  -  A gentle washing process is required; e.g. Easy-Care programme
  -  An especially gentle washing process is required; e.g. Delicates/Silk programme
  -  Suitable for washing by hand; e.g. Wool programme
  -  Do not machine wash.



## Starching

**Note:** Laundry should not be treated with fabric softener.

1. Switch on the appliance.
2. Select the **Rinse** programme.
3. Manually add the dosage of liquid starch into the dispenser for manual dosing (if required, clean it beforehand) in accordance with the manufacturer's instructions.
4. Touch the ▷ button.

## Dyeing/bleaching

Dye should only be used in normal household quantities. Salt may damage stainless steel. Always follow the dye manufacturer's instructions.

Do **not** use the appliance to bleach clothes.

## Detergent

### Correct selection of detergent

The care label is crucial for selecting the correct detergent, temperature and treatment of the laundry. → See also [www.sartex.ch](http://www.sartex.ch)

If you visit [www.cleanright.eu](http://www.cleanright.eu), you will find further information on detergents, care products and cleaning agents for domestic use.

- **Standard detergent with optical brighteners**  
Suitable for boil-washable white laundry made from linen or cotton  
Programme: Cottons/  
cold - max. 90 °C
- **Detergent for colours without bleach or optical brighteners**  
Suitable for coloured laundry made from linen or cotton  
Programme: Cottons/  
cold - max. 60 °C
- **Detergent for colours/delicates without optical brighteners**  
Suitable for coloured laundry made from easy-care fibres, synthetic fibres  
Programme: Easy-Care/  
cold - max. 60 °C
- **Detergent for delicates**  
Suitable for delicate, fine fabrics, silk or viscose  
Programme: Delicate/Silk/  
cold - max. 40 °C
- **Detergent for woollens**  
Suitable for wool  
Wool programme/  
cold - max. 40 °C

## Saving energy and detergent

































For light and normal soiling, you can save energy (lower washing temperature) and detergent.









Saving	Soiling/note
<p>Reduced temperature and detergent quantity as per the recommended dosage</p>  <p>Temperature as per the care label and detergent quantity as per the recommended dosage for heavy soiling</p>	<p><b>Light</b> No visible dirt or stains. Clothing has taken on some body odour, e.g.:</p> <ul style="list-style-type: none"><li>■ Light summer/sports clothing (worn for a few hours)</li><li>■ T-shirts, shirts, blouses (worn for up to one day)</li><li>■ Guest bed linen and hand towels (used for one day)</li></ul>
	<p><b>Normal</b> Visible dirt or a few light stains, e.g.:</p> <ul style="list-style-type: none"><li>■ T-shirts, shirts, blouses (sweat soaked, worn a few times)</li><li>■ Towels, bedding (used for up to one week)</li></ul>
	<p><b>Heavy</b> Dirt and/or stains clearly visible, e.g. tea towels, baby items, work clothing</p>

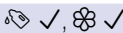

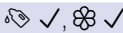

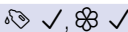

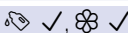

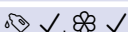
**Note:** When measuring the amount of all detergents/additives/care products and cleaning agents, please always check the manufacturer's instructions and information.

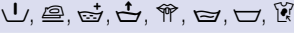
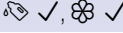

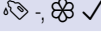

Programme/Type of washing	Options/Information
<p><b>Textile Guard</b></p> <p>For gentle cleaning of water-resistant and breathable fabrics. We recommend using a mild detergent. Do not use fabric softener and remove any potential fabric softener residue from the detergent dispenser before starting.</p> <ol style="list-style-type: none"> <li>Select a programme.</li> </ol> <p><b>Notes</b></p> <ul style="list-style-type: none"> <li>To run a waterproofing cycle, do not change this default setting. The programme stops before the waterproofing cycle.</li> <li>If you only want to wash the laundry, deselect the  <b>Rinse Hold</b>, if necessary. The programme will then not stop before the waterproofing cycle, and instead runs through to the end of the programme.</li> </ul> <ol style="list-style-type: none"> <li>For washing the laundry, use a special detergent for outdoor textiles; add the correct dosage to the left-hand compartment in accordance with the manufacturer's instructions. Thoroughly clean the compartment beforehand.</li> <li>Start the programme. The programme stops before the waterproofing cycle (depending on the  <b>Rinse Hold</b> setting).</li> <li>For waterproofing the laundry, add the dosage of waterproofing agent (max. 170 ml) to the dispenser for manual dosing.</li> <li>Press the  button to continue the programme. After-treat the laundry in accordance with the manufacturer's instructions.</li> </ol>	<p>Max. load 1 kg</p> <p>Cold - 40 °C</p> <p>400 - 800 rpm</p> <p>       </p> <p>  -</p>
<p><b>Duvet</b></p> <p>For gentle cleaning of microfibre blankets, pillows and clothing filled with down or synthetic fibres. Wash larger items individually. We recommend using a small dose of a detergent designed for delicates.</p>	<p>Max. load 2.5 kg</p> <p>Cold - 60 °C</p> <p>400 - 1200 rpm</p> <p>    </p> <p>  -</p>
<p><b>Hygiene</b></p> <p>For cleaning cotton and linen fabrics that have particularly strict hygienic requirements (e.g. for people with allergies).</p>	<p>Max. load 6.5 kg</p> <p>Cold - 60 °C</p> <p>400 - 1400 rpm</p> <p>       </p> <p>   </p>
<p>* depending on the model and the programme.                  ** reduced load with <b>varioSpeed</b>.</p>	

Programme/Type of washing	Options/Information
<p><b>Curtains</b></p> <p>For cleaning heavy and light curtains. Reduced spinning prevents creases. We recommend using a special detergent.</p>	<p>Max. load 3.5 kg</p> <p>Cold - 40 °C</p> <p>Off - 800 rpm</p> <p></p> <p></p>
<p><b>myTime</b></p> <p>The programme duration can be adjusted individually. For cleaning different fabrics (cotton, synthetic fibres and mixed fabrics) in one washing cycle.</p> <p>The duration of this washing programme can be self set from 20 minutes to maximum 60 minutes, with 10-minute increments.</p> <p><b>Note:</b> Increase the length of the wash programme with <b>Extra Rinse</b>.</p>	<p>Max. load 2 kg</p> <p>Cold - 40 °C</p> <p>400 - 1200 rpm</p> <p></p> <p></p>
<p><b>Rapid 15</b></p> <p>For washing lightly soiled laundry quickly (cotton, synthetic fibres and mixed fabrics) in 15 minutes.</p>	<p>Max. load 2 kg</p> <p>Cold - 40 °C</p> <p>400 - 1200 rpm</p> <p></p> <p></p>
<p><b>Auto</b></p> <p>For cleaning hard-wearing fabrics (cotton, synthetic fibres) in one washing cycle. The programme detects the fabric type and the degree of soiling and automatically adjusts the washing time, amount of detergent and water volume.</p> <p>The default temperature is 40 °C.</p>	<p>Max. load 6 kg</p> <p>-</p> <p>-</p> <p></p> <p></p>
<p><b>Auto gentle</b></p> <p>For cleaning delicate fabrics (cotton, synthetic fibres) in one washing cycle. The programme detects the fabric type and the degree of soiling and automatically adjusts the washing time, amount of detergent and water volume.</p> <p>The default temperature is 30 °C.</p>	<p>Max. load 3.5 kg</p> <p>-</p> <p>-</p> <p></p> <p></p>
<p>* depending on the model and the programme.</p> <p>** reduced load with <b>varioSpeed</b>.</p>	

Programme/Type of washing	Options/Information
<p><b>Cottons Eco</b> For cleaning normally soiled cotton clothing with optimised energy and water consumption.</p>	<p>Max. load 10 kg Cold - 90 °C 400 - 1400 rpm  </p>
<p><b>Rinse</b> For running separate rinse and spin cycles.</p>	<p>- - Off - 1400 rpm  </p>
<p><b>Spin</b> For running a separate spinning cycle.</p>	<p>- - Off - 1400 rpm  </p>
<p><b>Drain</b> For draining all the remaining water in the washing machine separately, e.g. after rinse hold.</p>	<p>- - - -  </p>
<p><b>Drum Clean</b> For antibacterial cleaning of the washing machine drum and rinsing the inlet and outlet hoses. <b>Note:</b> Always follow the manufacturer's instructions when dosing the detergent.</p>	<p>- - 1200 rpm  </p>
<p>* depending on the model and the programme. ** reduced load with <b>varioSpeed</b>.</p>	



## Sensors

### Unbalanced load detection system

The automatic unbalanced load detection system detects imbalances and ensures even distribution of the laundry by repeatedly starting and stopping drum spinning.

If the laundry is extremely unevenly distributed, the spin speed is reduced or the spin cycle is not performed for safety reasons.

**Note:** Place large and small items of laundry evenly in the drum.

### Aqua-Sensors

Depending on the programme and model

During a rinse cycle, the Aqua sensor checks the turbidity of the rinsing water (turbidity is caused by dirt and detergent residue). The duration and the number of rinse cycles depend on the turbidity of the water.



## Cleaning and maintenance



### Warning Risk of death!

There is a risk of electric shock if touch live components.

Press the button  and pull out the mains plug.

### Caution!

#### Fire and explosion hazard!

Toxic vapours can be produced by cleaning agents that contain solvents, e.g. cleaning solvent.

Do not use cleaning agents that contain solvents.

### Caution!

#### The appliance may be damaged!

Cleaning agents that contain solvents, e.g. cleaning solvent, can damage surfaces and components in the appliance.

Do not use cleaning agents that contain solvents.

### Appliance housing/control panel

- Remove the detergent residue immediately.
- Wipe the housing and the control panel with a soft, damp cloth.
- Do not use abrasive cloths, sponges or detergents (stainless steel cleaner).
- Do not clean the appliance with a water jet.

### Drum

Use chlorine-free cleaning agents, do not use steel wool.

If there are odours in the appliance, or to clean the drum, run the **Drum Clean** programme without laundry.

### Descaling

Descaling should not be necessary if the detergent is measured out correctly. However, if it is required, follow the manufacturer's instructions for the descaling agent. Suitable descalers can be obtained via our website or from customer services.



## i-Dos detergent draw and its housing

### 1. Emptying the dispensers:

The detergent drawer can be removed completely to allow you to clean the dispensers after you have emptied them.

The dispensers have emptying outlets with removable sealing plugs at the front. To empty the dispensers, first remove the drawer handle as shown below:

a) Pull out the detergent drawer.

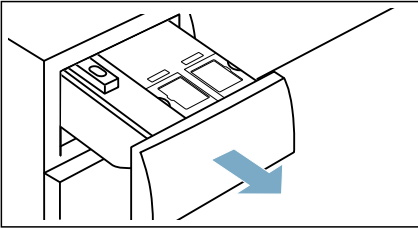

b) Pull the catch (A) on the back of the drawer handle (in the centre at the bottom) slightly towards you. This unlocks the drawer handle (B), which you can then pull off by lifting it upwards.

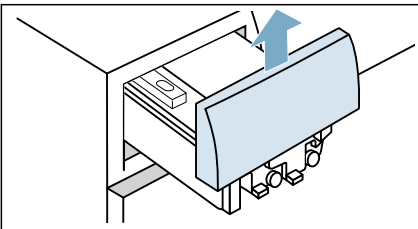
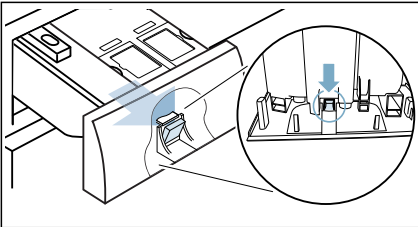

**Note:** Only put the drawer handle back on after you have finished cleaning.

c) To empty the dispensers, carefully pull off each of the sealing plugs and empty the contents into a suitable container.

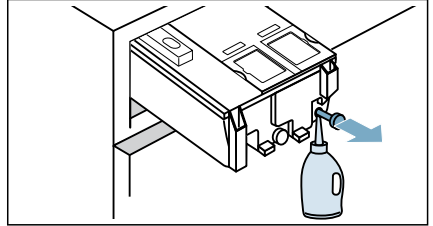

d) Then push the sealing plugs back in completely.

### 2. Cleaning the dispensers/detergent drawer:

a) Press the catch and remove the drawer completely.

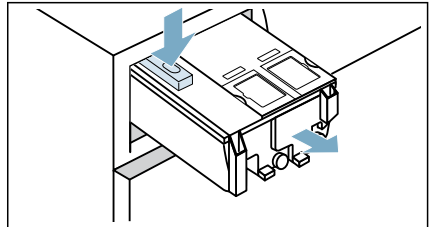

b) Carefully remove the drawer cover.

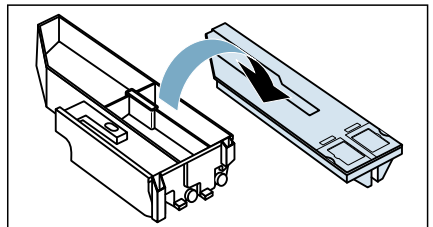

**Caution!**

Risk of damage to the detergent drawer.

The detergent drawer contains electrical components. These may become damaged if they come into contact with water.

- Do not clean the cover in the dishwasher and do not immerse it in water.



- Protect the rear drawer connector against water, detergent or fabric-softener residue; if necessary, clean the outer surfaces with a soft, damp cloth. Dry before putting back in.

- c) Clean the drawer and the cover with a soft, damp cloth or a hand shower. Also clean the inner surfaces with a soft, damp cloth.

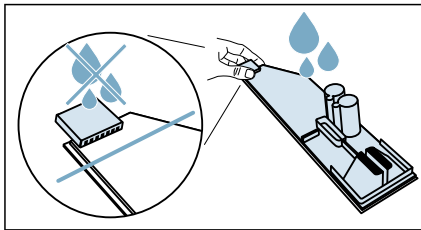

- d) Dry the drawer and the cover and put them back together.

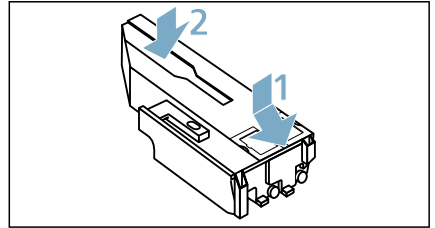

- e) Push the drawer handle back in from above until you feel it click in place.

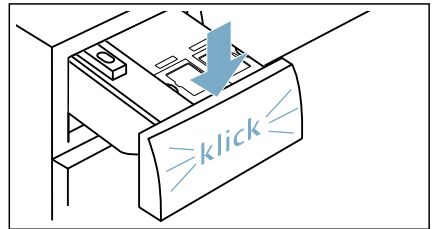

- f) Push the detergent drawer in completely.

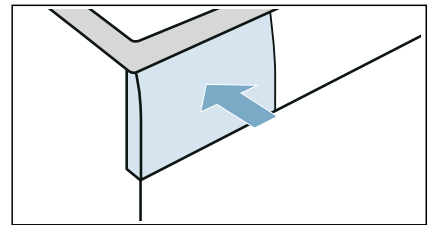

## Drain pump is blocked

**Note:** Turn the water tap off to prevent more water from flowing in and to ensure that it is drained via the pump.

### **Warning**

#### **Risk of scalding!**

When you wash at high temperatures, the water gets very hot. If you come into contact with the hot water, you may be scalded.

Allow the water to cool down first.

1. Press the  button. Pull out the mains plug.
2. Open the service flap.

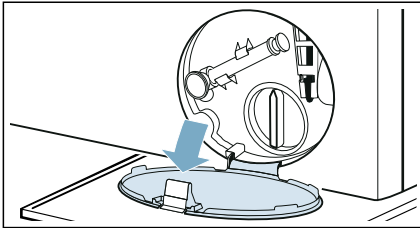

3. Take the drain hose out of the retainer. Remove the sealing cap and pour the water out into a suitable container. Replace the sealing cap and place the drain hose back in the retainer.

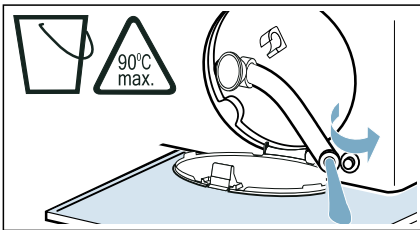

4. Carefully unscrew the pump cover; residual water may leak out. Clean the interior, pump cover thread and pump housing. The impeller in the drain pump must be able to rotate.

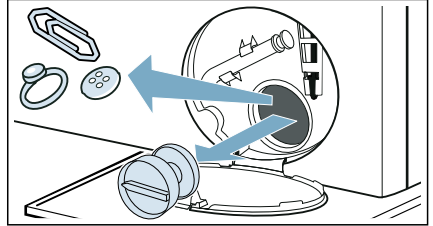

5. Refit and screw on the pump cover. The handle must be in a vertical position.

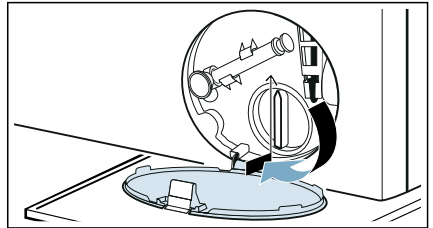

6. Close the service flap.

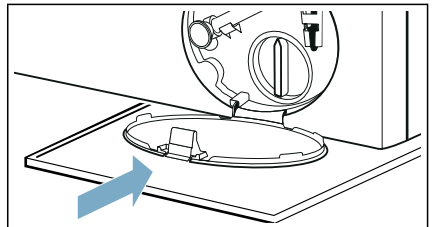

**Note:** To prevent unused detergent from flowing straight into the drain during the next wash: Pour 1 litre of water into the dispenser for manual dosing and start the **Rinse, Spin** or **Drain** programme.

## The drain hose at the siphon is blocked

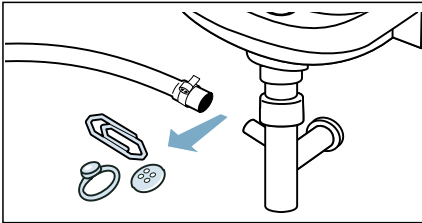

1. Press the  button. Pull out the mains plug.
2. Loosen the hose clamp. Carefully remove the drain hose; residual water may leak out.
3. Clean the drain hose and siphon connecting piece.



4. Re-attach the drain hose and secure the connection point using the hose clamp.

## Filter in the water supply is blocked

### Release water pressure in the supply hose:

1. Turn off the water tap.
2. Select any programme (except **Rinse, Spin and Drain** programmes).
3. Select the  button. Allow the programme to run for approx. 40 seconds.
4. Press the button .
5. Pull out the mains plug.

### Clean the filters:

1. Disconnect the hose from the rear of the appliance.

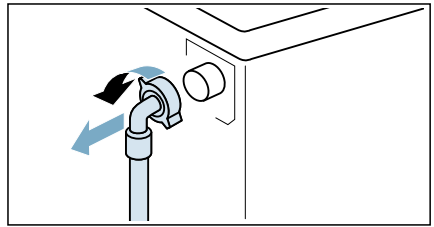

2. Use pliers to remove the filter.

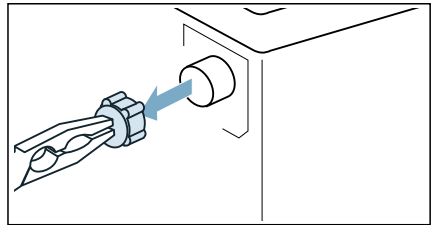

3. Clean the filter with a small brush.

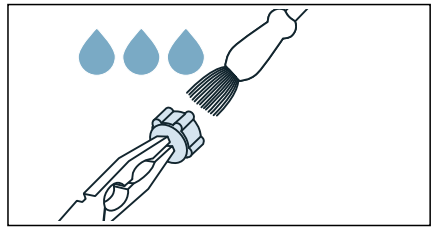

4. Connect the hose and check for leaks.

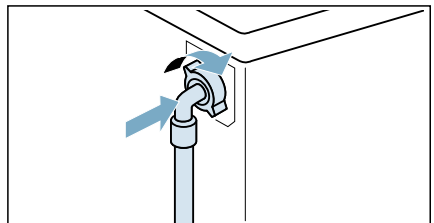

## Faults and what to do about them

### Emergency release

E.g. power outage or in the event of a loss of power

The programme continues when the power supply is restored.

However, if the laundry has to be removed, the appliance door can be opened as follows:

#### **Warning**

#### **Risk of scalding!**

When you are washing at high temperatures, there is a risk of scalding if you come into contact with hot water and laundry. If possible, leave it to cool down first.

#### **Warning**

#### **Risk of injury!**

Reaching into the drum while it is still turning may cause hand injuries. Do not reach into the drum when it is turning. Wait until the drum has stopped turning.

#### **Caution!**

#### **Water damage!**

Any escaping water may cause water damage.

Do not open the door if water can be seen through the glass.

1. Press the  button. Pull out the mains plug.
2. Open the service flap.

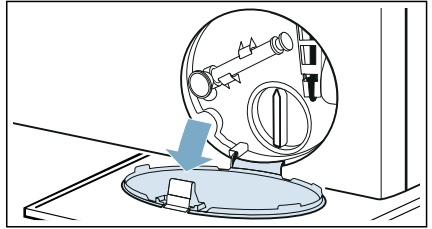

3. You can find a vacuum cup on the drain hose, take it out of the drain hose.

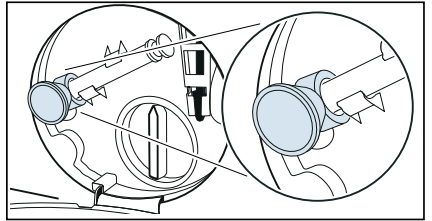



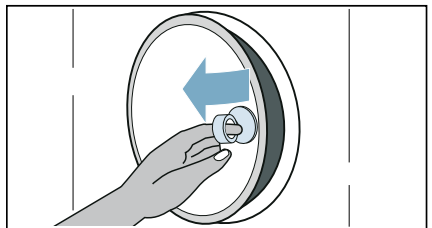
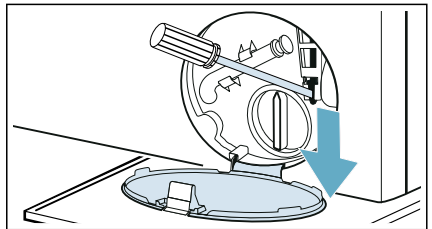

4. Drain the water. → [Page 55](#)
5. Pull the emergency release downwards with a tool and release. And use the vacuum cup to open the door.



## Faults and what to do about them

Faults	Cause/Remedy
Water is leaking from the appliance.	<ul style="list-style-type: none"> <li>■ Attach the drain hose correctly or replace it.</li> <li>■ Tighten the screw fitting on the supply hose.</li> </ul>
The appliance is not filling with water.	<ul style="list-style-type: none"> <li>■ Programme does not start?</li> <li>■ Is the tap turned on?</li> <li>■ Could the filter in the water supply be blocked? → <i>"Filter in the water supply is blocked"</i> on page 56</li> <li>■ Is the supply hose kinked or trapped?</li> </ul>
Detergent/fabric softener is not being dispensed.	<ul style="list-style-type: none"> <li>■ Is the appliance filled with water?</li> <li>■ Is detergent/fabric softener congealed in the dispenser(s)?</li> <li>■ Is the i-Dos pump unit blocked? Emptying the dispenser(s), pour about 50°C water into the dispenser(s). Do not fill the dispensers above the <b>max.</b> mark, and soaking for about 1 hour, then empty the dispenser(s) and pour detergent/fabric softener again. If you cannot rectify the fault yourself, please call customer services.</li> </ul>
The wrong detergent/fabric softener has been poured into the dispenser(s).	<p>Dispenser(s):</p> <ol style="list-style-type: none"> <li>1. Empty and clean.</li> <li>2. Refill.</li> </ol>
Detergent/fabric softener has congealed in the dispensers.	Clean and refill the dispensers.
Unable to open door.	<ul style="list-style-type: none"> <li>■ The safety function is activated. Stop the programme?</li> <li>■ Can the door only be opened by the emergency release? → <i>"Emergency release"</i> on page 57</li> <li>■ Childproof lock is activated? For continuing please hold "Deactivate child lock" for 3 seconds.</li> <li>■ Water temperature too high. Please wait until the door buttonlights up and then try again.</li> <li>■ Water level too high. Please start "Drain" programme first.</li> <li>■ Stopping drum. Please wait until the door button lights up and then try again.</li> <li>■ Door opener has overheated. Please wait until the door buttonlights up and then try again.</li> <li>■ Door blocked. Remove any objects near the door and try again.</li> <li>■ Programme running. Please pause the programme and then try again.</li> </ul>
The programme will not start.	<ul style="list-style-type: none"> <li>■ Have you touched the ▷    button or selected ⏸ <b>Delayed start</b> time?</li> <li>■ Is the door closed?</li> <li>■ Detergent drawer open. Please close the detergent drawer.</li> <li>■ Childproof lock is activated? For continuing please hold "Deactivate child lock" for 3 seconds.</li> </ul>

Faults	Cause/Remedy
The water is not draining.	<ul style="list-style-type: none"> <li>■ Could the drain pump be blocked? → <i>"Drain pump is blocked" on page 55</i></li> <li>■ Could the drain hose at the siphon be blocked? → <i>"The drain hose at the siphon is blocked" on page 56</i></li> </ul>
Water is not visible in the drum.	Not a fault – the water is below the visible area.
The spin result is not satisfactory. Laundry wet/too damp.	<ul style="list-style-type: none"> <li>■ Not a fault – the unbalanced load detection system has interrupted the spin cycle because the laundry is unevenly distributed. Distribute small and large items of laundry evenly in the drum.</li> <li>■ Is  <b>Less Ironing</b> selected?</li> <li>■ Is  <b>Silent Wash</b> programme setting or <b>Silent Wash</b> programme selected (depending on the model)?</li> <li>■ Is the selected spin speed too low?</li> </ul>
The spin cycle runs several times.	Not a fault – the unbalanced load detection system is adjusting an imbalance.
The programme is taking longer than usual.	<ul style="list-style-type: none"> <li>■ Not a fault – the unbalanced load detection system is adjusting an imbalance by repeatedly distributing the laundry.</li> <li>■ Not a fault – the foam detection system is active – a rinse cycle has been switched on.</li> </ul>
Foam may come out of the detergent drawer.	<ul style="list-style-type: none"> <li>■ Automatic dosing: i-Dos check the dosage settings and, if required, reduce the basic dosage. If required, use a different liquid detergent/fabric softener.</li> <li>■ Manual dosing: Have you used too much detergent? Use less detergent in the next wash cycle.</li> <li>■ Immediate action: Mix one tablespoon of fabric softener with 1/2 litre of water and pour it into the manual dosing compartment (not suitable for outdoor clothing, sportswear or items stuffed with down).</li> </ul>
The length of the programme changes during the wash cycle.	Not a fault – the programme sequence is optimised for the specific washing process. This may change the length of the programme shown on the Touch-Display.
Residual water in the dispenser for manual dosing for the care product.	Not a fault – the effectiveness of the care product is not affected.
Odours, stain formation in the appliance.	Run the <b>Drum Clean</b> programme without laundry. Add washing powder or a detergent containing bleach. <b>Note:</b> To prevent foaming, only use half the amount of detergent recommended by the detergent manufacturer. Do not use detergents designed for woollens or delicates.
Repeated, intensive foaming.	<ul style="list-style-type: none"> <li>■ Check your basic dosage of intelligent dosing system and dosage strength settings.</li> <li>■ If required, use a different liquid detergent.</li> </ul>

Faults	Cause/Remedy
I am unable to connect to my home network.	<ul style="list-style-type: none"> <li>■ Wi-Fi is switched off. To connect to your home network, switch on Wi-Fi.  must appear on the display.</li> <li>■ Wi-Fi is switched on but a connection to your home network cannot be established. Check whether your home network is available or try to connect to your home network again.</li> </ul>
Home Connect is not working.	<ul style="list-style-type: none"> <li>■ You can find solutions to problems with Home Connect at <a href="http://www.home-connect.com">www.home-connect.com</a>.</li> <li>■ The availability of the Home Connect functionality depends on the availability of the Home Connect Services (e.g. provision of the app) in your country. Home Connect Services are not available in every country – for further information please check: <a href="http://www.home-connect.com">www.home-connect.com</a>.</li> </ul>
Loud noises, vibrations and appliance "movement" during the spin cycle.	<ul style="list-style-type: none"> <li>■ Is the appliance aligned? → <i>"Alignment" on page 18</i></li> <li>■ Are the appliance's feet fixed? Secure the appliance's feet.</li> <li>■ Have the transport locks been removed? → <i>"Removing the transport locks" on page 14</i></li> </ul>
The Touch-Display indicator lights do not work while the appliance is running.	<ul style="list-style-type: none"> <li>■ Has there been a power failure?</li> <li>■ Have the fuses blown? Reset/replace the fuses.</li> <li>■ If the fault occurs repeatedly, call customer services.</li> </ul>
There is liquid detergent residue on the laundry.	<ul style="list-style-type: none"> <li>■ Some phosphate-free detergents contain water-insoluble residue.</li> <li>■ Select <b>Rinse</b> or brush the laundry after washing.</li> </ul>
Other faults	<p>You can rectify a fault yourself as the display shows. Or press the  button and pull out the mains plug. Turn off the tap and call customer services.</p>





## After-sales service

If you cannot rectify a fault yourself, (→ *"Faults and what to do about them" on page 57*), please contact our after-sales service.

We will always find an appropriate solution to avoid unnecessary visits by engineers.

Please provide the after-sales service with the product number (E-Nr.) and the production number (FD) of the appliance.

E-Nr. _____	FD _____
-------------	----------

E-Nr.	Product number
FD	Production number

You can find this information (depending on the model):

- On the inside of the loading door
- On the back of the appliance

**Trust the expertise of the manufacturer.** Contact us. By doing so, you can be sure that the repairs are carried out by trained service personnel using genuine spare parts.



## Consumption values table

### Energy and water consumption, programme duration and residual moisture for the main washing programme

(approximate values)

Programme	Load	Energy consumption*	Water consumption*	Programme duration*
Cottons 20 °C	10 kg	0,39 kWh	90 l	3 h
Cottons 40 °C	10 kg	1,29 kWh	90 l	3½ h
Cottons Eco 40 °C **	5 kg	0,47 kWh	47 l	6 h
Cottons Eco 60 °C **	5 kg	0,55 kWh	47 l	6 h
Cottons Eco 60 °C **	10 kg	0,82 kWh	60 l	6½ h
Cottons 60 °C	10 kg	1,55 kWh	90 l	3¼ h
Cottons 90 °C	10 kg	2,75 kWh	106 l	3 h
Easy-Care 40 °C	4 kg	0,85 kWh	62 l	2 h
Mixed Fabrics 40 °C	4 kg	0,66 kWh	45 l	1¼ h
Delicates/Silk 30 °C	2 kg	0,25 kWh	37 l	¾ h
Wool 30 °C	2 kg	0,22 kWh	41 l	¾ h

Programme	Approximate information on the residual moisture***	
	WM14U840... Max. 1400 rpm	
Cottons	48 %	
Easy-Care	40 %	
Delicates/Silk	30 %	
Wool	45 %	

Values determined according to EN60456.

\* Observed values may deviate from the indicated values due to influence of water pressure, hardness and inlet temperature, ambient temperature, type, amount and soiling of laundry, detergent used, fluctuations in power supply and selected additional functions.

\*\* Program settings with maximum spin speed for testing and energy labeling in accordance with EU Directive 2010/30/EU with cold water (15°C).

The programs are suitable for the cleaning of normally soiled cotton textiles and regarding the combination of energy and water consumption the most effective.

The specification of the programme temperature is based on the temperature stated on the care label in the textiles. The actual washing temperature may deviate from the indicated programme temperature for reasons of saving energy. The washing efficiency corresponds to the legal requirements.

\*\*\* Information on residual moisture based on program-dependent spin-speed limit and maximum loads.



## Technical data

### Dimensions:

848 mm x 598 mm x 622 mm  
(height x width x depth)

### Weight:

83 kg

### Mains connection:

Nominal voltage 220-240V, 50 Hz

Minimum installation protection (≡)  
10 A

Nominal power 1900-2300 W

### Water pressure:

100–1000 kPa (1–10 bar)

### Power consumption when in standby:

0.18 W

### Power consumption when ready for use (left-on mode):

0.18 W

### Power consumption when networked (Wi-Fi) in standby mode/duration:

2.3 W / 20 mins



## Aqua-Stop warranty

### Only for appliances with Aqua-Stop

In addition to warranty claims against the vendor based on the purchase agreement and to our appliance warranty, we will provide compensation under the following conditions:

1. If water damage is caused due to a fault in our Aqua-Stop system, we will compensate domestic customers for the damage caused.
2. The liability guarantee is valid for the service life of the appliance.
3. It is a prerequisite of all warranty claims that the appliance with Aqua-Stop must have been installed and connected correctly in accordance with our instructions; this also includes a correctly fitted Aqua-Stop extension (genuine accessories). Our warranty does not cover defective feed lines or fittings leading to the Aqua-Stop connection at the tap.
4. Appliances with Aqua-Stop do not need to be supervised during operation, nor secured afterwards by turning off the tap.  
The tap only needs to be turned off if you are away from home for a long period, e.g. for several weeks' holiday.

## Repair order and advice in the event of faults

GB 0344 892 8999 (Calls charged at local or mobile rate.)

IE 01450 2655 (0.03 € per minute at peak. Off peak 0.0088 € per minute.)

You can find the contact information for all countries in the attached after-sales service directory.

BSH Hausgeräte GmbH

Carl-Wery-Straße 34

81739 München

GERMANY

[siemens-home.bsh-group.com](http://siemens-home.bsh-group.com)

Manufactured by BSH Hausgeräte GmbH under Trademark License of Siemens AG



9001298503 (0003)