



BOSCH



Register your
new device on
MyBosch now and
get free benefits:
**[bosch-home.com/
welcome](https://www.bosch-home.com/welcome)**

Washer dryer

WVG30462SG

[en] User manual and installation
instructions

Your new washer dryer

You have chosen a Bosch washer dryer.

Please take a few minutes to read and become familiar with the advantages of your washer dryer.

To meet the high quality demands required by Bosch, every washer dryer that leaves our factory is carefully checked to ensure that it functions correctly and is in perfect condition.

For more information on our products, accessories, replacement parts and services, see our website www.bosch-home.com or contact our after-sales service centres.

If the operating and installation instructions describe different models, any differences will be pointed out at the relevant points in the text.



Read these operating and installation instructions before switching on the washer dryer.

Display rules

Warning!

This combination of symbol and signal word indicates a possibly dangerous situation. Not heeding the warning can cause death or injuries.

Caution!

This signal word indicates a possibly dangerous situation. Not heeding the caution can cause property and/or environmental damage.

Note/tip

Information about the optimum use of the appliance/any other useful information.







1. 2. 3. / a) b) c)







The steps are represented by numbers or letters.





■ / -

Lists are represented by a small box or a dash.

Contents

	Intended use	4
	Safety instructions	5
	Electrical safety	5
	Risk of injury	5
	Safety for children	5
	Protection of the environment	6
	Packaging/old appliance	6
	Hints and tips	6
	The main points in brief	7
	Getting to know your appliance	8
	Washer dryer	8
	Control panel	9
	Display panel	10
	Laundry	12
	Preparing laundry for washing	12
	Preparing laundry for drying	13
	Operating the appliance	14
	Preparing the washer dryer	14
	Selecting the programme/Switching on the appliance	14
	Adjusting the washing programme	14
	Adjusting the drying programme	15
	Loading the laundry	15
	Dosing and adding detergent and care product	16
	Starting the programme	17
	Childproof lock	17
	Reloading the laundry	17
	Changing the programme	18
	Interrupting or ending the programme	18
	End of the programme	18
	After washing/drying	19

	Overview of programmes	20
	Programme on the programme selector	20
	Drying table	23
	Starching	24
	Dyeing/Bleaching	24
	Soaking	24
	Changing programme default settings	24
	°C Temp.	24
	⌚ rpm	24
	🕒 Finished in	25
	☀ Dry	25
	Selecting additional functions	26
	⚙ Speed Perfect	26
	🌿 Eco Perfect	26
	👤 Aqua Plus	26
	Setting the signal	27
	Cleaning and maintenance	28
	Machine housing/Control panel	28
	Drum	28
	Descaling	28
	Cleaning the detergent dispenser	28
	Drain pump blocked	29
	Drainage hose on the siphon blocked	29
	Filter in the water inlet hose blocked	30
	Faults and what to do about them	31
	Emergency release, e.g. if a power failure occurs	31
	Information on the display panel	31
	Faults and what to do about them	32

	Customer service	35
	Technical specifications	35
	Consumption values	36
	Positioning and connecting.	37
	Included with the appliance	37
	Safety instructions	38
	Installation surface	38
	Installing the appliance on a base or on a wooden joist ceiling.	38
	Installing the appliance in a kitchenette	38
	Removing the transport locks	39
	Hose and cable lengths.	39
	Water inlet	40
	Water outlet	40
	Alignment	41
	Electrical connection	42
	Before washing/drying for the first time.	42
	Transportation	43

Intended use

- For private domestic use only.
- The washer dryer is suitable for machine washable textiles and hand washable wool and for drying certain types of textiles according to care instructions.
- The appliance is suitable for operation with cold mains water and commercially available detergents and care products which are suitable for use in a washer dryer.
- Always follow the manufacturer's instructions when dosing all detergents, cleaning aids, cleaning products and cleaning agents.
- The washer dryer may be operated by children from 8 years of age, by persons who have limited physical, sensory or mental abilities and by persons who have inadequate experience or knowledge, provided they **are supervised** or **have been instructed** by a responsible person. Children must not perform any cleaning or maintenance work without supervision.
- Keep children under the age of 3 years away from the washer dryer.
- Keep pets away from the washer dryer.
- Install and operate the washer dryer in a room which has an outflow.

Before operating the appliance: Read the installation and operating instructions and all other information enclosed with the washer dryer, and use the machine accordingly.

Retain documents for subsequent use.

Safety instructions

Electrical safety

Warning

Danger of death!

Danger of death if live parts are touched.

- When disconnecting the mains plug, always pull the plug itself and not the cable, otherwise the cable could be damaged.
- Never touch or hold the mains plug with wet hands.

Risk of injury

Warning

Risk of injury!

- If the washer dryer is lifted using projecting parts (e.g. the washer dryer door), these components may break off and cause injuries.
Do not lift the washer dryer by its projecting parts.
- If you climb onto the washer dryer, the worktop may break and cause injuries.
Do not climb onto the washer dryer.
- If you lean/support yourself on the open door, the washer dryer may overturn and cause injuries.
Do not lean on the open washer dryer door.
- If you reach into the rotating drum, you may injure your hands.
Do not grip the rotating drum.
Wait until the drum stops rotating.

Warning

Risk of scalding!

- When washing at high temperatures, you may be scalded if you touch the hot washing water (e.g. if draining hot washing water into a washbasin).
Do not touch the hot washing water.
- If a drying programme was interrupted, the washer dryer and laundry may be very hot. Select **Intensive dry** ☀ or **Gentle dry** ☀ and select 15 min drying time to cool down the laundry and then remove.

Safety for children

Warning

Danger of death!

If children play with the washer dryer, they may get into life-threatening situations or injure themselves.

- Do not leave children unattended near the washer dryer.
- Do not let children play with the washer dryer.

Warning

Danger of death!

Children may lock themselves in appliances, putting their lives at risk.

For appliances that have reached the end of their service life:

- Disconnect the mains plug.
- Cut through the mains cable and remove it, along with plug.
- Destroy the lock on the washer dryer door.

 **Warning**
Risk of choking!

Children may become wrapped in packaging/film or packing parts if allowed to play with them, or they may pull them over their heads and suffocate.

Keep packaging, film and packaging parts out of the reach of children.

 **Warning**
Risk of poisoning!

Detergents and care products may be poisonous if consumed. Keep detergents and care products out of the reach of children.

 **Warning**
Eye / skin irritation!

Detergents and care products may cause irritation if they come into contact with the eyes or skin. Keep detergents and care products out of the reach of children.

 **Warning**
Risk of injury!

When you wash/dry at high temperatures, the glass in the washer dryer door gets hot. Do not let children touch the hot washer dryer door.

 **Protection of the environment**

Packaging/old appliance











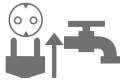
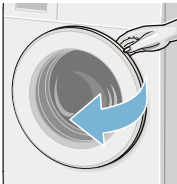
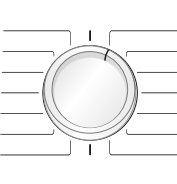

Dispose of packaging in an environmentally friendly manner.

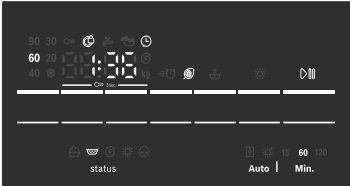
This appliance has been identified in accordance with the European Directive 2012/19/EU on Waste Electrical and Electronic Equipment (WEEE). The Directive specifies the framework for an EU-wide valid return and recycling of waste appliances.

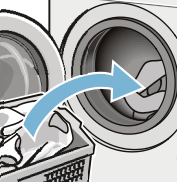
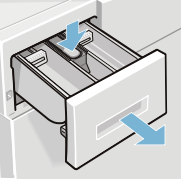
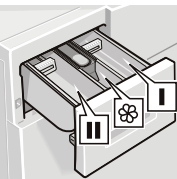
Hints and tips

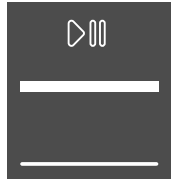
- Utilise the maximum amount of laundry for the particular programme.
Overview of programmes
→ Page 20
- Wash normally soiled laundry without prewash.
- **Energy saving mode:** The display panel light goes out after several minutes,  flashes. To reactivate the display, select any button. The energy-saving mode is not activated if a programme is running.
- The selectable temperatures apply to the care labels on the textiles. The temperatures in the machine may deviate from this so that you get the optimum mix of energy-saving and washing results.
- If the laundry is then dried in the appliance, select the maximum possible spin speed. The less water the laundry contains, the less time and energy are required for drying. Do not dry dripping wet laundry.

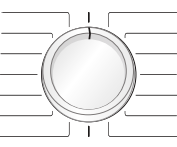
The main points in brief

1				
	<p>Plug into the mains. Turn the tap on.</p>	<p>Open the washer dryer door.</p>	<p>Select the washing/ drying programme</p>	<p>Max. load and/or remaining time in display panel.</p>
2				
	<p>If required, change the programme default settings and/or select additional functions.</p>	<p>Sort the laundry.</p>	<p>Load the laundry.</p>	
3				
	<p>Open the detergent drawer.</p>	<p>Dose detergent according to the dosing recommendation. → Page 16</p>	<p>Close the washer dryer door.</p>	<p>Select  Start/ Reload.</p>
4				
	<p>End of the programme.</p>	<p>Set programme selector to Off.</p>	<p>Open the door and remove the laundry.</p>	<p>Turn off the water tap, and disconnect the mains plug.</p>

Getting to know your appliance

Washer dryer

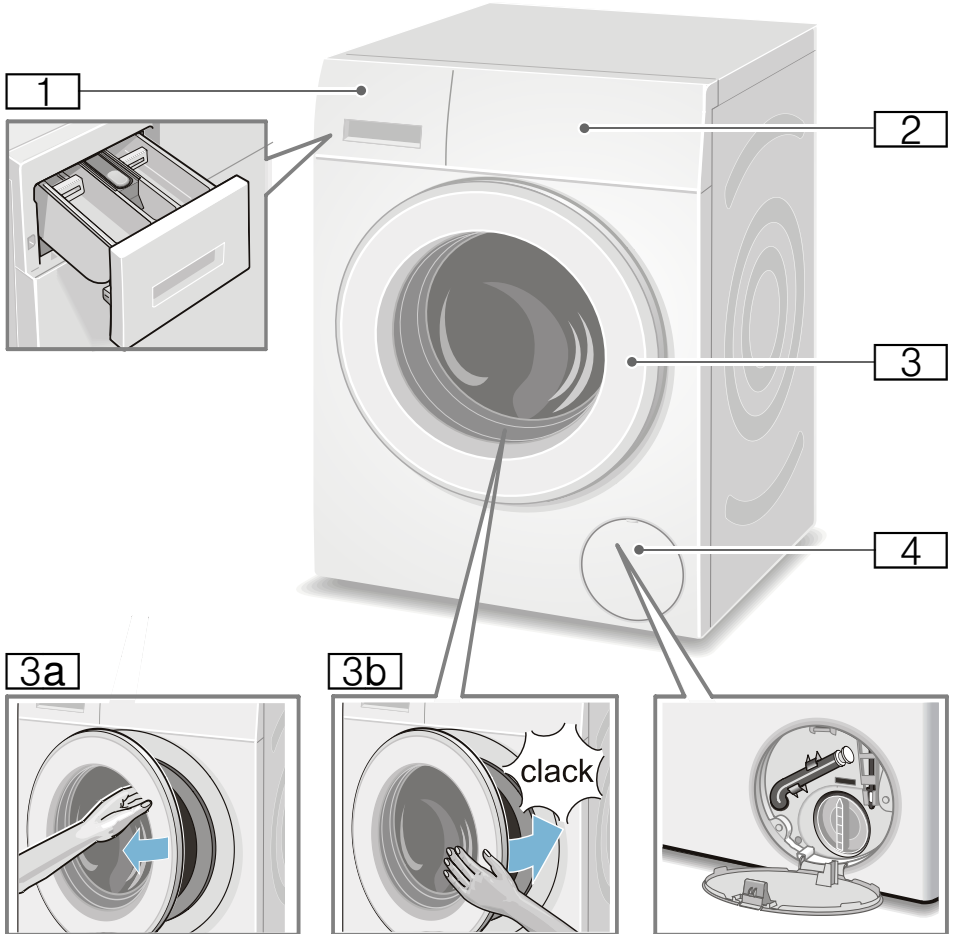

- 1 Detergent drawer
- 2 Operating/display panel
- 3 Door with handle
- 3a Open the door
- 3b Close the door
- 4 Service flap

Control panel

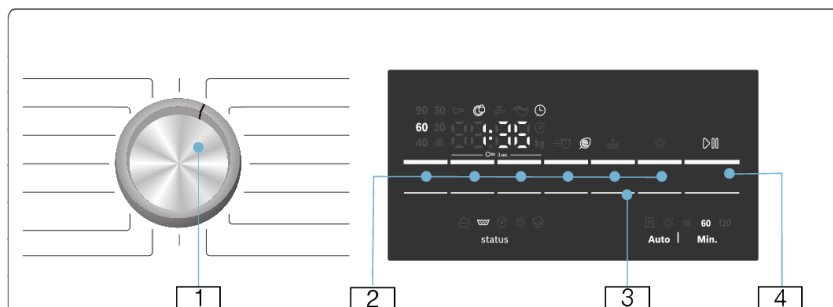







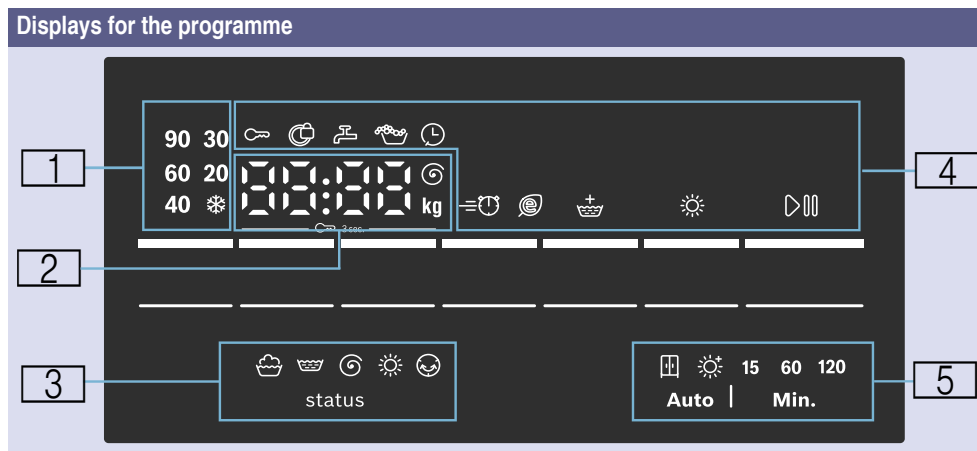







Change the default settings for the selected programme and select additional functions:

- 1 Select a programme. Can be rotated in either direction. To switch off the washer dryer, set the programme selector to **Off**.
- 2 Select buttons **°C Temp.**, **rpm** (Spin speed), **Finished in** and **Dry** for changing default settings. → *Page 24*
Select buttons **Speed Perfect** / **Eco Perfect** and **Aqua Plus** for additional functions.
→ *Page 26*
- 3 Display panel for information.
- 4 Start programme. Select the **Start/Reload** button to start, interrupt (e.g. reload laundry) and cancel the programme.
→ *Page 17*

Display panel



1	Temperature for washing programme	❄ (cold) – 90°	Temperature in °C
2	Programme information	1:50*	Programme duration after programme selection in h:min (hours:minutes)
		1 – 24 h	Finish in time in h (h=hour)
		8.0 kg*	Max. load for selected programmes
		0 – 1500 Ⓢ*	Spin speed in revolutions per minute. If spin speed is selected as 0, all spinning processes will be cancelled and the water after final rinse cycle will be pumped out.
	Programme status	End	Programme end
		0:00	Wrinkle guard process is running → Page 18
		-----	End of programme with spin speed setting – ---
	Further information	E : - - *	Fault display
		0*	Setting the signal → Page 27
3	Programme progress symbols		Washing
			Rinsing
			Draining/Spinning
			Drying
			Wrinkle guard

4 Programme information and additional function symbols	 lights up	On if childproof lock has been activated → <i>Page 17</i>
	 flashes	The childproof lock is activated, and if the programme selector has been adjusted or the buttons have been pressed
	 lights up	When the door is locked
	 flashes	When pressing the Start/Reload button to start the programme, the door is not closed properly.
	 lights up	Water pressure too low. This extends the programme duration
	 flashes	The tap has not been turned on or there is no water pressure
		On if too much foam detected, additional rinse cycle added on
		On if finish in time was selected
	Speed Perfect	
Eco Perfect		
Aqua Plus		
Dry		On if drying function is activated.
Start/Reload		On if the appliance is running; flashes if the appliance is ready or paused.
5 Selectable drying mode and dry time		Cupboard dry (Auto dry)
		Extra Dry (Auto dry)
	15	15 minutes machine cooling
	60, 120	60/120 minutes time dry
* Depends on selected programmes/additional functions.		



Laundry

Preparing laundry for washing

Sorting laundry according to:



Sort your laundry according to the care instructions and specifications of the manufacturer on the care labels:





- Type of fabric/fibre
- Colour

Note: Laundry can discolour or not be cleaned correctly. Wash white and coloured items separately. Wash new bright fabrics separately the first time you wash them.

- Soiling
 - **light**
do not prewash; if necessary select the  **Speed Perfect** additional function.
 - **normal**
Select programme with prewash. If required, pretreat stains.
 - **heavy**
Load less laundry. Select programme with prewash. If required, pretreat stains.
 - **Stains:** Remove/pretreat stains while they are fresh. Firstly, dab with a soap water; do not rub. Then select the appropriate programme and wash the items. Stubborn or dried-in stains can sometimes only be removed by washing several times.
 - Symbols on the care labels

Note: The numbers in the symbols indicate the maximum washing temperature that may be used.

-  Suitable for normal washing process; e.g. Cottons programme
-  A gentle washing process is required; e.g. Easy-Care programme

-  An especially gentle washing process is required; e.g. Delicates/Silk programme
-  Suitable for washing by hand; e.g.  Wool program
-  Do not machine wash.

Protecting your laundry and washer dryer:

Caution! Damage to the appliance/textiles

Foreign objects (e.g. coins, paper clips, needles, nails) may damage the laundry or components of the washer dryer.

The following instructions must be observed when preparing your laundry:

- Always follow the manufacturer's instructions when dosing all detergents, cleaning aids, care products and cleaning agents.
- Do not exceed maximum load. Overfilling will impair the washing result.
- Keep detergents and agents for the pretreatment of laundry (e.g. stain remover, prewash sprays, etc.) away from the surfaces of the washer dryer. Using a damp cloth, immediately remove any fine spray residue and other residue or droplets.
- Empty any pockets. Remove any foreign objects.

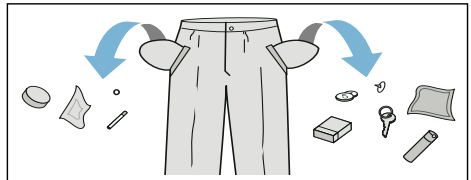

- Remove metal parts (paper clips, etc.).
- Trousers, knitwear and knitted textiles, e.g. jersey garments, T-shirts or sweatshirts, should be turned inside out.





- Ensure that underwired bras are machine-washable.
- Wash delicates in a net or bag (tights, underwired bras, etc).
- Close zips, button up covers.
- Brush sand out of pockets and collars.
- Remove curtain fittings or include in the net/bag.

Preparing laundry for drying

Note: To ensure an even drying result, sort the laundry according to the:

- Type of fabric
- Drying programme
- Care symbols which are indicated on the care labels.

Only dry laundry which is labelled “dryer-proof” or which has the following care symbols:

-  = Dry at normal temperature
(**Intensive dry** )
-  = Dry at low temperature
(**Gentle dry** )

The following textiles must not be dried:

-  = care symbol “Do not dry”
- Wool or textiles containing wool.
- Delicates (silk, synthetic curtains).
- Textiles which contain foam rubber or similar materials.
- Textiles which were treated with flammable liquids, e.g. with stain remover, petroleum ether, thinners. Risk of explosion!
- Textiles which still contain hairspray or similar substances.

Notes

- Before drying, hand-washed textiles must be spun at the appropriate spin speed.
- Before drying, spin at the optimum speed. A spin speed of more than 1000 rpm is recommended for cotton, more than 800 rpm for easy-care textiles.
- Do not iron laundry immediately after drying. It is recommended to roll the laundry up first to distribute residual moisture evenly.
- To ensure a good drying performance, quilts, terry cloths and other large textiles should be dried separately. Do not dry more than 5 terry cloths (or 4 kg).
- Do not exceed the maximum load.



Operating the appliance

Preparing the washer dryer

The washer dryer was tested before delivery. To remove residual water from the test procedure, the first wash cycle should be run without laundry using the **Drum clean** programme.

Before washing/drying for the first time
→ Page 42

Note:

- Never switch on a damaged washer dryer!
- Inform your customer service! → Page 35

1. Insert mains plug.
2. Turn the tap on.
Due to the use of the water condensation technology for drying, please keep the connected water tap open during the drying process, otherwise proper drying cannot be guaranteed.

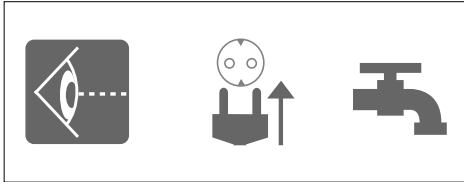

3. Open the door.

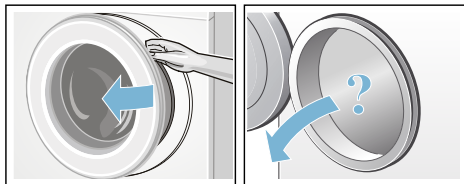

Selecting the programme/ Switching on the appliance

Note:

If you have activated the childproof lock, you must deactivate it before you can set a programme.

- Select the required programme with the programme selector. Can be rotated in either direction.
The washer dryer is switched on.

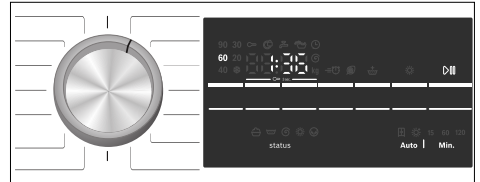

The following figures are indicated continuously on the display panel for the selected programme:

- the programme duration,
- the preset temperature,
- the maximum load (if the door is open).

Adjusting the washing programme

You can use the displayed default settings or adjust the selected programme optimally to the laundry items by changing the default settings or selecting additional functions. The selectable settings and additional functions depend on the selected washing/drying programme.

Overview of programmes → Page 20

Notes

- Options can be selected, deselected or changed depending on the progress of the programme.

- The buttons are sensitive, they only need to be touched gently. If the button **°C Temp.**, **rpm**, **Finished in** is held down, the setting options are automatically scrolled through.

Changing default settings for a washing programme, e. g. washing temperature:

- Touch the **°C Temp.** button to set desired washing temperature.

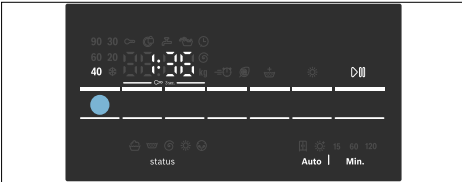

Changing the additional functions for a washing programme, e.g. select **Speed Perfect:**

- Touch the **Speed Perfect/Eco Perfect** button until the indicator light comes on.

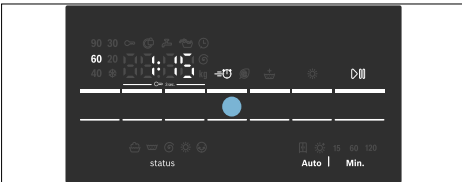

Note:
After changing the programme default settings and/or additional functions, the programme duration may change.

Adjusting the drying programme

Note:

If an individual drying programme or washing and drying without interruption is selected, you can change the default settings for the drying programme if required.

Overview of programmes → Page 20

Changing the default settings for a drying programme:

- Touch the **Dry** button to set the desired drying mode or drying time (only for an individual drying programme).

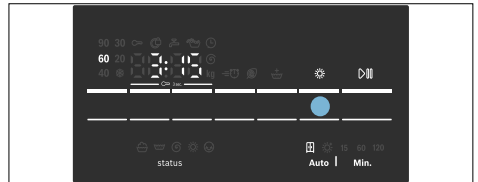

Note:

After changing the default settings for the drying programme, the programme duration may change.

Loading the laundry

Warning
Danger of death!

Laundry items pretreated with solvent-based detergents, e.g. stain remover/petroleum ether, may cause an explosion if loaded into the washer dryer.

Thoroughly rinse laundry items by hand before washing.

Notes

- Mix large and small items. Laundry items of different sizes distribute themselves better during the spin cycle. Individual laundry items may cause an unbalanced load.

en Operating the appliance

- Observe the indicated maximum load. Overfilling adversely affects the washing result and promotes creasing.
1. Unfold presorted laundry items and place in the drum.
 2. Ensure that no laundry items are trapped between the door and rubber seal.



3. Close the door.

Note: The indicator light on the ▷|| Start/Reload button flashes and the default settings for the programme appear continuously on the display panel. Changes may be made to the default settings.

Dosing and adding detergent and care product

Caution!

Damage to the appliance

Detergents and agents for the pretreatment of laundry (e.g. stain remover, prewash sprays, etc.) may damage the surfaces of the washer dryer.

Keep these agents away from the surfaces of the washer dryer. Using a damp cloth, immediately remove any fine spray residue and other residue/droplets.

Dosing

Dose the detergents and care products according to:

- water hardness (ask your water supply company),
- the manufacturer's specifications on the packaging,

- the amount of laundry,
- soiling.

Filling the dispensers

1. Pull out the detergent drawer.

⚠ Warning

Eye / skin irritation!

If the detergent drawer is opened while the appliance is running, detergent/care product may run out. Carefully open the drawer.

If detergent/care product comes into contact with eyes or skin, rinse thoroughly.

If accidentally swallowed, seek medical advice.

2. Pour in detergent and/or cleaning product.

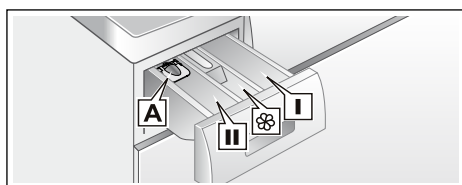

- | | |
|--------------|---|
| Dispenser I | Detergent for prewash. |
| Dispenser ⌘ | Softener, starch. Do not exceed the maximum load. |
| Dispenser II | Detergent for main wash, water softener, bleach, stain remover. |
| Dispenser A* | For dosing liquid detergent. |

*depending on the model

Notes

- Always follow the manufacturer's instructions when dosing all detergents, cleaning aids, care products and cleaning agents.
- Dilute viscous fabric softener and fabric conditioner with water. This will prevent blockages.
- Be careful when opening the detergent drawer while the appliance is running.

- If an individual drying programme is selected, please do not add detergent and/or care product in the appliance.

Measuring aid* for liquid detergent

*depending on the model

Position the measuring aid for measuring the correct amount of liquid detergent:

1. Pull out the detergent drawer. Press down the insert and fully remove the drawer.
2. Slide the measuring aid forwards, fold it down and click it into place.
3. Reinsert the drawer.

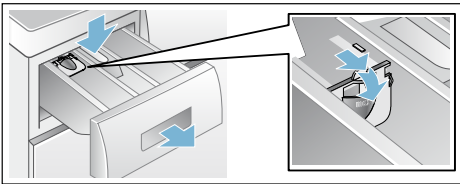

Note: Do not use the measuring aid for gel detergents and washing powder, or for programmes with prewash or when "Finish in" time is selected.

For models without a measuring aid, pour the liquid detergent into the appropriate dispenser and place it in the drum.

Starting the programme

Touch the **Start/Reload** button. The indicator lamp is lit and the programme starts.

Note: If you want to secure the programme to prevent it from being adjusted inadvertently, select the childproof lock.

The display panel shows the Finished in time while the programme is running or the programme duration and the



programme progress symbols when the washing programme has started.

Display panel → *Page 10*

Childproof lock

You can secure the washer dryer to prevent the set functions from being changed inadvertently. To do this, activate the childproof lock when the programme has started.

Activating/deactivating: Touch and hold the buttons **rpm** and **Finished in** for approx. 3 seconds. The symbol  is indicated in the display. If the button signal is activated, an acoustic signal sounds.

-  lights up: The childproof lock is activated.
-  flashes: The childproof lock is active and the programme selector has been adjusted. To prevent the  symbol from flashing, reset the programme selector to the initial programme. The symbol lights up again.

Note:

The childproof lock may remain activated until the next programme starts, even after the washer dryer has been switched off. If this is the case, deactivate the childproof lock before the programme starts and, if required, re-activate after the programme starts.

Reloading the laundry

When the programme has started, the laundry can be reloaded or taken out as required.

Touch the **Start/Reload** button. The washer dryer checks whether reloading is possible.

Notes

- If there is a high water level, high temperature or if the drum is rotating, the door remains locked for safety reasons and reloading is not possible.
If the following is indicated on the display panel:
☉ is lit → Reloading is not possible. To continue the programme, select the ▷ Start/Reload button.
- Do not open the door until the door lock symbol ☉ goes out.
- Do not leave door open for a prolonged period – water could run out of the laundry.
- The reloading function cannot be activated during the drying phase.

Changing the programme

If you have started the wrong programme by mistake, you can change the programme as follows:

1. Select ▷ Start/Reload.
2. Select another programme. If required, adjust the default settings and/or select additional functions.
3. Select ▷ Start/Reload. The new programme starts from the beginning.

Interrupting or ending the programme

For programmes at high temperature:

1. Select ▷ Start/Reload.
2. To cool down laundry: Select Rinse ☹.
3. Select ▷ Start/Reload.

For programmes at low temperature:

1. Select ▷ Start/Reload.
2. Select Spin/Drain ☹/☹.
3. Select ▷ Start/Reload.

For drying programmes:

1. Select **Intensive dry** ☼ or **Gentle dry** ☼.
2. Touch button ☼ **Dry** and set drying time to 15 minutes.
3. Select ▷ Start/Reload.

End of the programme

End or **----** (**Rinse stop** = without final drain/spin cycle) is indicated in the display and acoustic signal sounds.

Setting the signal → *Page 27*

If **----** (**Rinse stop** = without final drain/spin cycle) was selected, press ▷ Start/Reload button to start the final drain/spin cycle.

Notes

- The programme continues by pumping out the water and spinning the laundry (the standard spin speed can be changed beforehand).
- If only the water is to be pumped out, approx. 1 minute after the programme starts, touch the ▷ Start/Reload button before the spin cycle starts. The programme is interrupted and the door lock is released. The laundry can be removed.
- If **Hot** flashes in the display before the drying programme ends, the temperature in the drum is high. The programme for cooling the drum runs until the temperature in the drum has dropped.
- Wrinkle guard process starts after drying process is finished to prevent laundry getting wrinkle if you do not take laundry out in time. The process lasts about 30 minutes. **0:00** will be displayed in time display and ☹ symbol will be displayed as the status symbol. You can press any button or rotate the programme selector to another position to terminate this process, then the door will be released and laundry can be taken out.

After washing/drying

1. Open the door and remove the laundry.
2. Turn the programme selector to **Off**. The appliance is switched off.
3. Turn off the tap.
Not required for Aqua-Stop models.

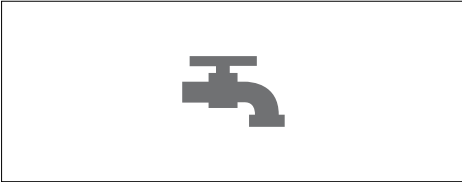

Notes



























- Do not leave any items of laundry in the drum. In the next wash they may shrink or discolour another item.
- Remove any foreign objects from the drum and the rubber seal – risk of rust.



























- Leave the detergent drawer and door open so that residual water can evaporate.
- Always remove the laundry.
- Always wait until the programme ends, as the appliance could still be locked. Then switch the appliance on and wait for the unlocking device.
- When the display panel has gone out at the end of the programme, energy-saving mode is active. To activate the display again, select any button.

Overview of programmes

Programme on the programme selector

Programme/Type of laundry	Options/Information
<p>Name of the programme Brief explanation of the programme and which textiles it is suitable for.</p>	<p>maximum load according to EN50229 maximum load for washing/ maximum load for drying selectable temperature in °C selectable spin speeds in rpm possible additional functions for washing possible settings for drying</p>
<p>Cottons Standard washing program for hard-wearing textiles made of cotton or linen. Note: * Reduced load for  additional functions.</p>	<p>max. 8(5)* kg/5 kg  (cold) – 90 °C ----, 400 – 1500 rpm , ,  , </p>
<p>+ Prewash Energy-intensive program for heavily soiled hard-wearing textiles made of cotton or linen. Note: * Reduced load for  additional functions.</p>	<p>max. 8(5)* kg/5 kg  (cold) – 90 °C ----, 400 – 1500 rpm , ,  , </p>
<p>Easy-Care Textiles made of synthetic materials or blended fabrics.</p>	<p>max. 4.0 kg/2.5 kg  (cold) – 60 °C ----, 0 – 1200 rpm , ,  , </p>
<p>Mix Mix consisting of textiles made of cotton and synthetics.</p>	<p>max. 4.0 kg/2.5 kg  (cold) – 40 °C ----, 0 – 1500 rpm , ,  , </p>

Programme/Type of laundry	Options/Information
<p>Allergy Plus Hardwearing textiles made of cotton or linen.</p> <p>Notes</p> <ul style="list-style-type: none"> Especially suitable for increased hygienic demands or particularly sensitive skin on account of prolonged washing at a defined temperature, with a higher water level and longer rinsing cycle. * Reduced load for  additional functions. 	<p>max. 6.5(5)* kg/4 kg</p> <p> (cold) – 60 °C</p> <p>-----, 400 – 1500 rpm</p> <p>, , </p> <p>, </p>
<p>HygieneCare An innovative program, pretreat dry laundry by hot air (up to 70°C) to for increased hygienic demands, followed by a low temperature washing cycle. Achieves both hygiene effect and fabric care. Suitable for most non-delicate textile.</p>	<p>max.4 kg/4 kg</p> <p> (cold) – 30 °C</p> <p>-----, 0 – 1500 rpm</p> <p>, , </p> <p>, </p>
<p>Down Machine-washable fabrics that are filled with down.</p> <p>Notes</p> <ul style="list-style-type: none"> Wash large items separately. Use special down washing detergent. 	<p>max.1.5 kg/1 kg</p> <p> (cold) – 60 °C</p> <p>-----, 0 – 1200 rpm</p> <p>, , </p> <p>, </p>
<p>Rinse Washable textiles, Extra rinse with spin.</p>	<p>-/max. 5 kg</p> <p>-</p> <p>-----, 0 – 1500 rpm</p> <p></p> <p></p>
<p>Spin/Drain Single spinning program with selectable spin speed. To select the Drain  programme, set the spin speed to 0.</p>	<p>-/max. 5 kg</p> <p>-</p> <p>0 – 1500 rpm</p> <p>-</p> <p></p>
<p>Super 15' /Wash&Dry 60' For small amount (≤1kg) lightly soiled garments made of cotton, linen, synthetic or blended fabrics. Approx. 15 mins for washing. If drying function is selected, it's followed by another approx. 45 mins drying process.</p>	<p>max. 2 kg/1 kg</p> <p> (cold) – 40 °C</p> <p>-----, 0 – 1200 rpm</p> <p></p>

Programme/Type of laundry	Options/Information
<p>Wool</p> <p>Hand and machine-washable fabrics made of wool or wool blend; particularly gentle wash programme to prevent shrinkage of laundry, with longer programme breaks (soaking garments in the detergent solution).</p> <p>Note:</p> <ul style="list-style-type: none"> Wool is of animal origin, e.g.: Angora, alpaca, llama, sheep. Use a detergent suitable for machine washable wool. 	<p>max. 2 kg</p> <p>❄ (cold) – 40 °C</p> <p>----, 0 – 800 rpm</p> <p>–</p> <p>–</p>
<p>Delicate/Silk</p> <p>For delicate, washable textiles, e.g. made of silk, satin, synthetic fibres or blended fabrics.</p> <p>Note:</p> <p>Use a detergent suitable for machine washable delicate fabrics or silk.</p>	<p>max. 2 kg</p> <p>❄ (cold) – 40 °C</p> <p>----, 0 – 800 rpm</p> <p>☹, ☺, ☼</p> <p>–</p>
<p>Drum clean</p> <p>Special program for drum hygiene or fluff removal:</p> <p>90 °C = antibacterial program, do not use detergent.</p> <p>40 °C = antibacterial program; special drum cleaning detergent can be used.</p> <p>❄ (cold) = rinsing programme for the removal of fluff which has collected in the washer drum during the drying phase.</p>	<p>0</p> <p>❄ (cold), 40, 90 °C</p> <p>1200 rpm</p> <p>–</p> <p>–</p>
<p>Gentle dry</p> <p>Single Gentle dry programme for drying garments with lower temperature,</p> <ul style="list-style-type: none"> - by selecting ☐ to achieve automatic cupboard dry result, - by selecting ❄ to achieve automatic extra dry result, - self-defined drying time selectable from 15, 60 to 120 mins <p>Note:</p> <p>** 15 min drying time is for cooling down the laundry and machine after drying process.</p>	<p>max. 2.5 kg</p> <p>–</p> <p>–</p> <p>–</p> <p>☐, ❄, Time dry**</p>
<p>Intensive dry</p> <p>Single normal dry program for drying garments with higher temperature,</p> <ul style="list-style-type: none"> - by selecting ☐ to achieve automatic cupboard dry result, - by selecting ❄ to achieve automatic extra dry result, - self-defined drying time selectable from 15, 60 to 120 mins. <p>Note:</p> <p>** 15 min drying time is for cooling down the laundry and machine after drying process.</p>	<p>max. 5 kg</p> <p>–</p> <p>–</p> <p>–</p> <p>☐, ❄, Time dry**</p>

Drying table

Load type	Recommended drying programme	Drying load (kg)	Estimated drying time (min)	
			Cupboard dry ☒	Extra dry ✳
Cottons/coloureds (color fast textiles made of cotton or linen such as underwear, T-shirts, pullover, kitchen towels, terry cloths, bed sheets, table cloths, work clothes, bath towels)	Intensive dry ☀	0.5 - 2.0	40 - 90	60 - 100
		2.0 - 3.5	90 - 160	100 - 180
		3.5 - 5.0	160 - 220	180 - 225
Easy-care (textiles made of synthetic materials or blended fabrics such as shirts, sportswear)	Gentle dry ☁	0.5 - 1.5	35 - 75	40 - 120
		1.5 - 2.5	75 - 120	120 - 190
	Drying programme	Drying load (kg)	Adjustable drying time (min)	
	Time Dry	~1.0	60	
		~2.5	120	

- i The times are approximate and refer to a normal load, standard spin programme and room temperature.
- i The maximum selectable drying time is 120 min. If the laundry weighs more than 2.5 kg, select automatic drying. This function is recommended to ensure good drying results and save energy. The 15-minute drying programme is used to cool the laundry.
- i To get evenly dried result, separate thick layered fabric from lightweight ones. For example, separate terry cloth from shirts.
- i Extra dry ✳ is recommended for terry cloth and other large or thick layered textiles.
- i Reduce the maximum load mass for terry cloth to 4kg for throughout drying.
- i Wool must not be dried in the washer dryer.
- i To receive less wrinkled drying result, load less laundry.

Starching



Note: The laundry should not be treated with fabric softener.

Liquid starch can be used in all wash programmes. Pour starch into the dispenser  according to manufacturer's specifications (if required, clean beforehand).

Dyeing/Bleaching

Dye in household quantities only. Salt may attack stainless steel! Observe specifications of the dye manufacturer!
Do not bleach laundry in the washer dryer!

Soaking

1. Pour soaking agent/detergent into dispenser **II** according to the manufacturer's instructions.
2. Set the programme selector to **Cottons 60°C** and select  **Start/Reload**.
3. After approximately 10 minutes select  **Start/Reload** to pause the programme.
4. After the required soaking time, reselect  **Start/Reload** if the programme is to be continued or change the programme.

Note: Load laundry of the same colour. No additional detergent is required, the soaking solution is used for washing.

P+ Changing programme default settings

You can change the default settings for selected programmes. The settings can be changed even while the selected programme is running. The effects depend on the progress of the programme.

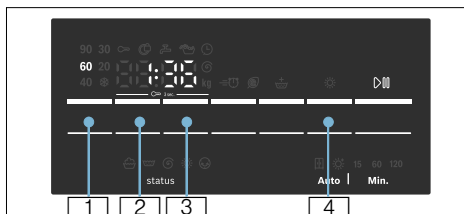

°C Temp.

 The indicated washing temperature can be changed. The maximum selectable washing temperature varies depending on the selected programme.

Overview of programmes → *Page 20*

rpm

 The spin speed can be changed before and during the programme (in rpm, revolutions per minute) depending on the progress of the programme. Setting **----** (**Rinse stop** = without final drain/spin cycle), laundry remains in the water after the last rinse cycle. Setting **0** (Without any spin cycle), drain the rinsing water only, no spin cycle. The maximum spin speed depends on the programme and model.

Overview of programmes → *Page 20*

Finished in



 Define the Finish in time (end of programme).

Note: The respective programme duration is displayed by selecting the programme. The programme duration is automatically adjusted while the programme is running if the programme duration needs to be changed, e.g. due to changes in the programme default settings.

Before the programme starts, the end of the programme can be preselected in hourly increments up to a maximum of **24h**.

When the programme has started, the preselected time is displayed e.g. **8h** and counts down until the programme starts. Then the programme duration is displayed, e.g. **2:30**.











When the programme has started, the preselected time can be changed as follows:

1. Touch the  **Start/Reload** button.
2. Touch the  **Finished in** button and change the Finish in time.
3. Touch the  **Start/Reload** button.

Dry

 The drying function can be activated, deactivated and set with this button. Washing and drying without interruption is possible in automatic mode only. If the programme for individual drying is selected, automatic drying or timed drying with a required drying duration is available.

Notes

- Programme selection in **Intensive dry**  or **Gentle dry**  position to select an individual drying programme. Overview of programmes → *Page 20*
The standard drying mode is . In this mode the drying time is automatically set according to the amount of laundry to be dried. The result is cupboard-dry laundry. Drying mode can be set to  in order to obtain an extra dry result; or preselect the drying time which can be specified by selecting the  **Dry** button.
- **Cupboard dry** (): For single-layer fabrics. Garments can be folded or hung up in a cupboard.
- **Extra dry** (): For fabrics made of thick, multilayered items of clothing, which need to be dried longer. Garments can be folded or hung up in a cupboard. Laundry more dry than Cupboard dry.
- Programme selection in washing programmes and if washing and drying is required without interruption (for **Optional drying** programmes):
 1. Touch button  **Dry** and activate the function  or .
 2. Do not exceed the maximum loads for drying.
Overview of programmes → *Page 20*
 3. Maximum spin speed for the washing programme will be selected automatically to obtain a good drying result.

P+ Selecting additional functions

You can select your desired additional functions by touching the respective buttons.

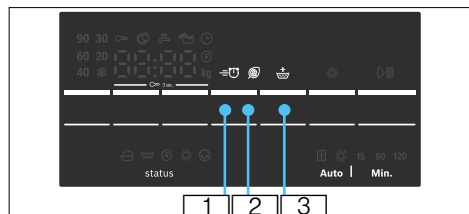

Speed Perfect

1 For a shorter wash time with a comparable washing result to the standard programme.

Note: Do not exceed maximum load.
Overview of programmes → *Page 20*

Eco Perfect

2 Energy-optimised washing by reducing the temperature while achieving a consistent washing result.

Note: The washing temperature is lower than the selected temperature. For special hygiene requirements, the **Allergy Plus** programme is recommended.

Aqua Plus

3 Increased water level and extended wash time. For areas with very soft water or for further enhancing the washing result.

Setting the signal

Setting signal volume

1. Activate setting mode for signal volume

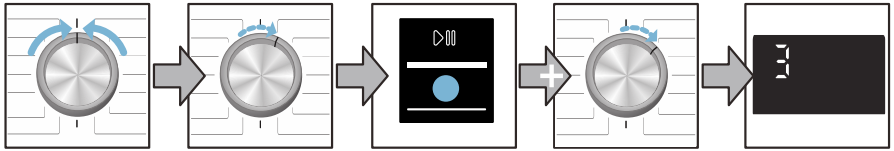

Turn to **Off**

1 step clockwise

Press and hold and

1 step clockwise

Release

2. a) Set volume for **information signals**

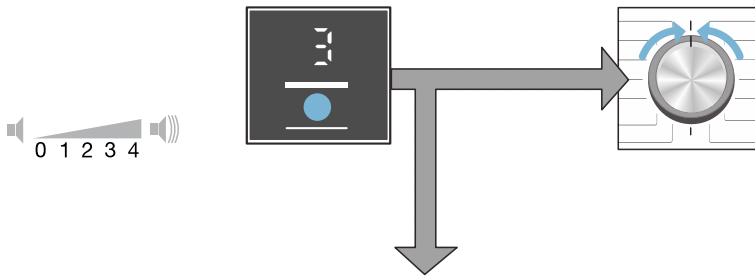

Press the **Finished in** and set Volume

or

Set to **Off**, setting mode for signal volume is left

2. b) Selecting volume of the **button signals**

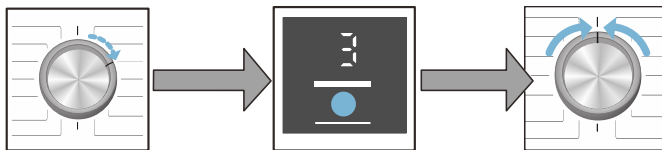

1 step clockwise

Press the **Finished in** and set Volume

Set to **Off**, setting mode for signal volume is left



Cleaning and maintenance



Warning

Risk of electric shock!

Danger of death if live parts are touched.

Switch off the appliance and disconnect at the mains plug.



Warning

Risk of poisoning!

Solvent-based cleaning agents, e.g. petroleum ether, in the washer dryer may cause toxic vapours.

Do not use solvent-based cleaning agents.

Caution!

Damage to the appliance

Solvent-based cleaning agents, e.g. petroleum ether, may damage the surfaces and components of the washer dryer.

Do not use solvent-based cleaning agents.

Machine housing/Control panel

- Immediately remove laundry and cleaning agent residue.
- Wipe with a soft, damp cloth.
- Do not use abrasive cloths, sponges or detergents (stainless steel cleaner).
- Do not clean the appliance with a water jet.

Drum

Use chlorine-free cleaning agents, do not use steel wool.

Descaling

Not required if detergent dosed correctly. However, if this does occur, follow the instructions of the descaling agent manufacturer. Suitable descalers can be purchased on our website or from customer service. → Page 35

Cleaning the detergent dispenser

If it contains detergent or fabric softener residue:

1. Pull out the detergent drawer. Depress the insert and remove the drawer completely.
2. Take out insert: using your finger, press insert upwards.

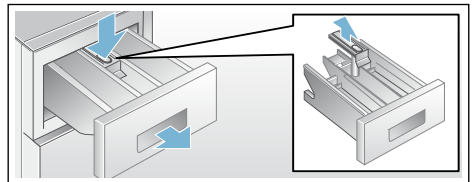

3. Clean the detergent dispenser and insert with water and a brush and dry.
4. Attach the insert and lock into position (push the cylinder onto the guide pin).
5. Insert detergent drawer.

Note: Leave the detergent drawer open so that residual water can evaporate.

Drain pump blocked

Warning **Risk of scalding!**

When you wash at high temperatures, the water gets very hot. If you come into contact with the hot water, you may be scalded.

Allow the water to cool down.

1. Turn off the tap so that no more water can flow in and has to be drained via the drain pump.
2. Switch off the appliance. Pull out the mains plug.
3. Open and remove the service flap.

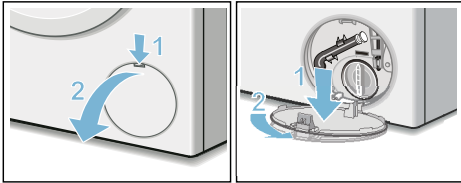

4. Take the drain hose out of the retainer. Remove the sealing cap and pour the water out into a suitable container. Replace the sealing cap and place the drain hose back in the retainer.

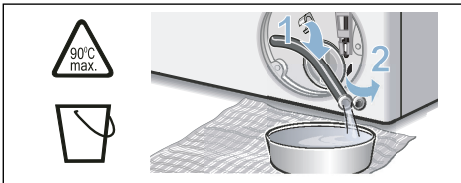

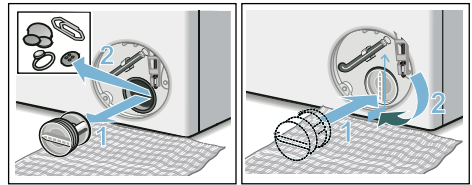

5. Carefully unscrew the pump cover; residual water may leak out. Clean the interior, pump-cover thread and pump housing. The impeller in the drain pump must be able to rotate. Refit the pump cover and screw it on tightly. The handle must be in a vertical position.

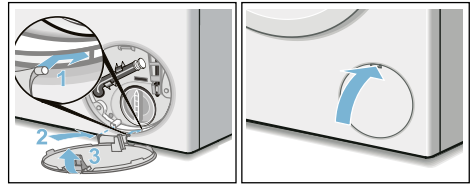

6. Place the service flap back on, lock it into place, and close it.



Note: To prevent unused detergent from flowing into the outlet during the next wash: Pour 1 litre of water into dispenser **II** and start the **Spin/Drain**  programme: (if only a drained cycle is required: set  **rpm** to **0**).

Drainage hose on the siphon blocked

1. Turn the programme selector to **Off**. Pull out the mains plug.
2. Loosen hose clip, carefully remove drainage hose. Residual water may run out.
3. Clean drainage hose and siphon spigot.

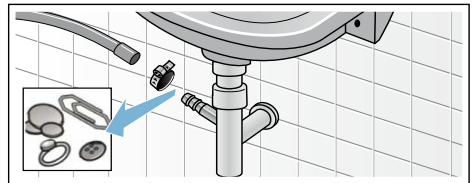

4. Re-attach the drainage hose and secure the connection point with the hose clip.



Filter in the water inlet hose blocked

Warning

Danger of death!

Do not immerse the Aqua-Stop safety device in water (it contains an electric valve).

First, reduce the water pressure in the supply hose:

1. Turn off the tap.
2. Select any programme (except **Spin / Drain** ).
3. Select  **Start/Reload**. Allow the programme to run for approx. 40 s.
4. Turn the programme selector to **Off**. Pull out the mains plug.
5. Clean the filter on the tap:
Disconnect the hose from the water tap.
Clean the filter with a small brush.

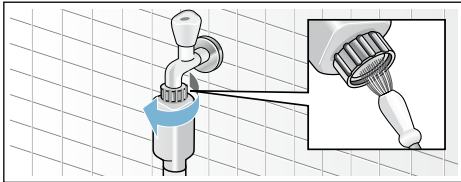

6. Clean the filter on the back of the appliance:
Remove the hose from the rear of the appliance.
Take out the filter with pliers and clean it.

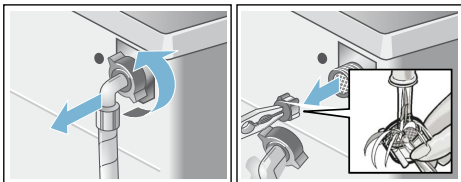

7. Connect the hose and check for leaks.

Faults and what to do about them

Emergency release, e.g. if a power failure occurs

e.g. in the event of a power cut

The programme will continue running when the power supply has been restored.

However, if the laundry has to be removed, the washer dryer door can be opened as follows:

Warning

Risk of scalding!

When you are washing at high temperatures, there is a risk of scalding if you come into contact with detergent solution and laundry.

If possible, leave it to cool down.

Warning

Risk of injury!

You may injure your hands if you reach into the drum while it is turning.

Do not reach into the drum when it is turning.

Wait until the drum has stopped turning.

Caution! **Water damage**



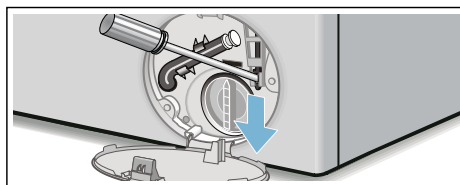

Any escaping water may cause water damage.

Do not open the washer dryer door if water can be seen through the glass.

1. Switch off the appliance. Disconnect the mains plug.
2. Drain the detergent solution.
3. Pull the emergency release downwards with a tool and release. The washer dryer door can then be opened.











Information on the display panel



Information	Cause/Remedy
	<ul style="list-style-type: none"> ■ Flashes fast + signal: The door was opened and the water level is too high. Close the door, continue the programme with  Start/Reload button or select Drain  programme. ■ Flashes slowly: The door lock temperature is too high to open the door. Wait approx. 30 seconds until the door lock cools down.
Hot	The door cannot be opened after the drying programme due to the high temperature. The cooling process continues until the display disappears, after which the door can be opened.
	<ul style="list-style-type: none"> ■ Flashes (no water supply): Tap turned on? Water inlet filter blocked? Clean the water inlet filter. → <i>Page 30</i> Water hose kinked or blocked? ■ Lights up (low water pressure): For information only. This will not affect the programme progress. The programme duration is extended.

Information	Cause/Remedy
E:18	Drain pump blocked; clean the drain pump. Clean the drainage hose on the siphon.
E:32	Alternating display with End when programme is finished: unbalance problem, spinning phase is aborted.
E:95	Alternating display with End when programme is finished: no water detected in drying phase, may get bad drying result.
Other displays	Turn the programme selector to Off . The appliance is switched off. Wait 5 s and switch on again. If the display is indicated again, call customer service.

Faults and what to do about them

Faults	Cause/Remedy
Water is running out.	<ul style="list-style-type: none"> ■ Correctly attach/replace drainage hose. ■ Tighten screw-fitting on the supply hose.
Water not flowing in. Detergent not dispensed.	<ul style="list-style-type: none"> ■  Start/Reload not selected? ■ Tap not open? ■ Filter blocked? Clean the filter → <i>Page 30</i> ■ Supply hose kinked or jammed?
The washer dryer door cannot be opened.	<ul style="list-style-type: none"> ■ Safety function active. Note: For safety reasons, the washer dryer door remains locked when the water level or temperature is high (See → Cancel the programme → <i>Page 18</i>) or while the drum is rotating. ■ - - - - (Rinse stop = without final drain/spin) selected? ■ Can be opened with emergency lock release only? → <i>Page 31</i> ■ Childproof lock active? Deactivate. → <i>Page 17</i>
Programme does not start.	<ul style="list-style-type: none"> ■  Start/Reload or  Finished in selected? ■ Door closed? ■ Childproof lock active? Deactivate. → <i>Page 17</i>
Detergent solution is not drained.	<ul style="list-style-type: none"> ■ - - - - (Rinse stop = without final drain/spin) selected? ■ Clean the drain pump. → <i>Page 29</i> ■ Clean outlet pipe and/or drainage hose.
Water not visible in the drum.	Not a fault – water below the visible area.
Spin result not satisfactory. Laundry wet/too damp.	<ul style="list-style-type: none"> ■ Not a fault – unbalance detection system has stopped the spin cycle, laundry unevenly distributed. Distribute small and large items of laundry in the drum. ■ Too low speed selected?
Spin cycle activated several times.	Not a fault – unbalanced load detection system adjusts imbalance.

Faults	Cause/Remedy
Residual water in the dispenser for care product.	<ul style="list-style-type: none"> ■ Not a fault – effect of the care product not impaired. ■ If required, remove the insert. Clean the detergent drawer and re-insert it.
Compartment  is not rinsed out completely.	Remove the insert. Clean the detergent drawer and reinsert it.
Odour formation in the washer dryer.	<ul style="list-style-type: none"> ■ Run the Drum clean 90°C programme without laundry and detergent. ■ Use appropriate detergent for daily washing. ■ keep the door and detergent dispenser open after using.
Status display  is on. Foam may come out of the detergent drawer.	<p>Too much detergent used?</p> <ul style="list-style-type: none"> ■ Mix 1 tablespoon of fabric softener with ½ litre of water and pour into dispenser II. (Not for outdoor, sports and down-filled textiles!) ■ Reduce detergent dosage for the next wash cycle. ■ Use commercially available low foam detergent and care products which are suitable for washer dryers.
Excessive noise, vibrations and “wandering” during the spin cycle.	<ul style="list-style-type: none"> ■ Appliance aligned? Align the appliance. → <i>Page 41</i> ■ Appliance feet fixed? Secure appliance feet. → <i>Page 41</i> ■ Transportation bolts are removed? Removing the transportation bolts. → <i>Page 39</i>
Display panel/indicator lights do not function while the appliance is running.	<ul style="list-style-type: none"> ■ Power failure? ■ Fuse tripped? Switch on/replace fuse. ■ If the fault occurs repeatedly, call customer service. → <i>Page 35</i>
The programme duration changes during the wash cycle.	<ul style="list-style-type: none"> ■ Not a fault – unbalanced load detection system adjusts imbalance. ■ Not a fault – foam detection function active. Additional rinse cycle.
Detergent residue on the laundry.	<ul style="list-style-type: none"> ■ Occasionally phosphate-free detergents contain water-insoluble residue. ■ Select Rinse  or brush items when the laundry is dry.
Spin noise during the drying phase.	This is an innovative process known as thermal spinning used to reduce energy consumption during the drying phase.
Fluff found on the washed laundry.	Run the Drum Clean  (cold) programme without laundry and detergent to remove fluff which have accumulated inside the drum during the previous drying cycle.
Water inlet noise during the drying phase.	The washer dryer uses water condensation technology, water is constantly needed to dry the laundry. Therefore the tap must be on all the time, till the end of drying phase.
Drying duration extended.	<ul style="list-style-type: none"> ■ Run the Drum Clean  (cold) programme to remove fluff which has collected in the washer drum during the drying phase.
Drying programme does not start.	<ul style="list-style-type: none"> ■ Drying programme not selected? Overview of programmes → <i>Page 20</i> ■ Door not closed properly?

Faults	Cause/Remedy
<p>The drying result is not satisfactory (laundry is not dry enough).</p>	<ul style="list-style-type: none"> ■ Excessively high ambient temperature (above 30 °C) or inadequate ventilation in the room in which the washer dryer is situated. ■ The laundry has not been spun well enough before drying. Always set the highest selectable spin speed for the particular washing programme. ■ Washer dryer overloaded: Observe the recommendations for the maximum load in the programme table and on the load display. Do not overload the washer dryer, as the maximum load for the drying phase is less than the maximum load for the wash cycle. Unload the washer dryer after washing with the maximum load and divide the laundry into two drying cycles. ■ The power supply voltage is too low (below 200 V) – provide a suitable power supply. ■ The water pressure is low. According to water condensing principle, low water pressure will cause evaporated steam not condensed totally. ■ The tap is closed during drying. Due to the use of the water condensation technology for drying, please keep the connected water tap open during the drying process, otherwise proper drying cannot be guaranteed. ■ Thick multilayered textiles or textiles with thick fillings dry easily on the surface, but not inside. This equalisation process may take longer. For these types of textiles, select drying mode  (Extra dry), or select additional time drying via Intensive dry  or Gentle dry  programmes.
<p>If a fault cannot be rectified (switching the machine on and off) or a repair is required:</p> <ul style="list-style-type: none"> ■ Set the programme selector to Off and pull out the mains plug. ■ Turn off the tap and call customer service. → <i>Page 35</i> 	



Customer service

If you cannot correct the fault yourself, see section, Faults and what to do about them → Page 32

Please contact our customer service. We will always find a suitable solution and aim to avoid unnecessary visits by technicians

Please give customer service the product number (E-Nr.) and the production number (FD) of the appliance.

E-Nr. _____ FD _____

Product number

Production number

You can find this information on: the inside of the door */opened service flap * and the back of the appliance.

*depending on model

Rely on the competence of the manufacturer.

Contact us. You can therefore be sure that the repair is carried out by trained service technicians who carry original spare parts.



Technical specifications

Dimensions:

850 x 600 x 590 mm

(height x width x depth)

Weight:

80 kg

Mains connection:

Nominal voltage 220 - 240 V/50 Hz

Minimum installation protection (≡) 10 A

Nominal power 1900 - 2300 W

Water pressure:

100 - 1000 kPa (1 - 10 bar)

Drain height:

60 - 100 cm

Power consumption when switched off:

0,12 W

Power consumption when switched on:

0,48 W



Consumption values

Programme	Option	Load (kg)	Energy consumption *** (kWh)	Water Consumption *** (liter)	Programme duration *** (hours)
Cottons 20 °C*		8,0	0,30	78	3
Cottons 40 °C*		8,0	1,06	78	3
Cottons 60 °C		8,0	1,08	78	3
Cottons 90 °C		8,0	2,20	88	3
Easy-Care 40 °C*		4,0	0,76	65	2
Mix 40 °C		4,0	0,62	46	1 ¼
Delicates/Silk 30 °C		2,0	0,16	36	¾
Wool 30 °C		2,0	0,20	40	¾
Intensive dry ☀		5,0	2,82	24	3 ¼
Gentle dry ☁		2,5	1,49	25	2
Cottons 60 °C **	🌀 Eco Perfect	8,0	0,83	71	7
Cottons 60 °C + Intensive dry ☀ **	🌀 Eco Perfect	8,0 / 5,0+3,0	5,44	118	13 ½

* Program setting for tests according to currently valid EU standard EN60456. For comparison test, please test the programs with specified load and maximum spin speed.

** EU energy label washing performance tests according to EN50229, are conducted using specified load on **Cottons 60 °C + 🌀 Eco Perfect**.

** EU energy label drying performance tests are conducted according to EN50229. Maximum washing load is divided into 2 drying cycles with **Intensive dry ☀ + 🗑 (Cupboard dry)** option. In the second drying cycle for 3kg, the load includes 3 bedsheets, 2 pillowcases and towels. The rest of load is included in the first drying cycle for 5kg.

*** The values may deviate from the stated values depending on the following factors: water pressure and hardness, inlet temperature, ambient temperature, type and amount of laundry, type and amount of detergent used, fluctuation of power supply and additional functions selected.



Positioning and connecting

Included with the appliance

Note: Check the machine for transport damage. Never use a damaged machine. If you have any complaints, contact the dealer from whom you purchased the appliance or our customer services. → *Page 35*

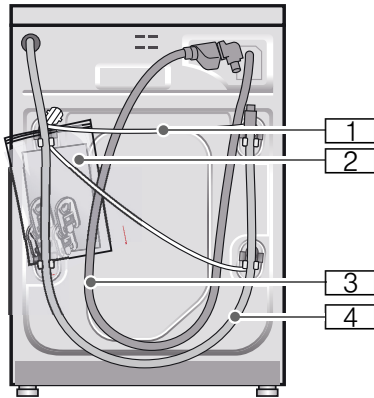

1 Mains cable

2 Bag:

- Installation and operating instructions
- Customer services location directory*
- Warranty*
- Cover caps for openings after the transport braces have been removed

3 Water supply hose on Aqua-Stop models

4 Water drain hose
5 Elbow for securing the water drain hose*

6 Water supply hose on standard/Aqua-Secure models

* depending on the model

In addition, a hose clamp (24 - 40 mm diameter, available from specialist dealers) is required to connect the water drain hose to a siphon.

Useful tools

- Spirit level for aligning → *Page 41*
- Spanner with:
 - WAF13 for loosening the transport braces, and → *Page 43*
 - WAF17 for aligning the appliance feet → *Page 41*

Safety instructions

Warning **Risk of injury!**

- The washer dryer is very heavy. Be careful when lifting/transporting the washer dryer.
- When the washer dryer is lifted by its protruding parts (e.g. the washer dryer door), the components may break off and cause injuries. Do not lift the washer dryer by protruding parts.
- If the hose and mains cables are not routed properly, there is a risk of tripping and injury. Lay hoses and cables in such a way that there is no risk of tripping.

Caution!

Damage to the appliance

Frozen hoses may rip/burst. Do not install the washer dryer in areas exposed to frost or outdoors.

Caution!

Water damage

The connection points for the water supply hose and water drain hose are under high water pressure. To prevent leaks and water damage, you must follow the instructions in this section.

Notes

- In addition to the safety information listed here, the local water and electricity supplier may have special requirements.
- If in doubt, have the appliance connected by a specialist.

Installation surface

Note: The washer dryer must be stable so that it does not move around.

- The installation surface must be firm and level.
- Soft floors/floor coverings are not suitable.

Installing the appliance on a base or on a wooden joist ceiling

Caution!

Damage to the appliance

The washer dryer may wander during the spin cycle and topple or fall off its base.

Always secure the washer dryer feet with holding brackets.

Holding brackets: order no.

WMZ 2200, WX 975600, CZ 110600, Z 7080X0.

Note: If installing on a wooden joist ceiling:

- If possible, install the washer dryer in a corner.
- Screw water-resistant wooden board (min. 30 mm thick) to the floor.

Installing the appliance in a kitchenette

Warning **Danger of death!**

There is a risk of electric shock if you touch live components. Do not remove the appliance covering plate.

Notes

- Recess width of 60 cm required.
- Only install the washer dryer underneath a continuous worktop that is securely connected to adjacent cabinets.

Removing the transport locks

Caution!

Damage to the appliance

- The machine is secured for transportation using transport locks. If the transport locks are not removed, the drum, for example, may become damaged when the machine is operated. Before using the appliance for the first time, make sure that you completely remove all four transport locks. Keep the locks in a safe place.
- To prevent transport damage from occurring if the appliance is moved at a later date, you must refit the transport locks before transporting the appliance.

Note: Keep the screws and sleeves in a safe place.

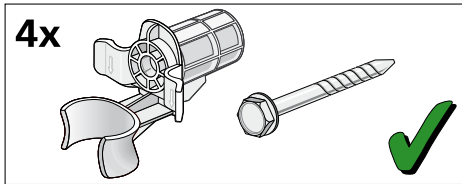

1. Take the hoses out of the holders.

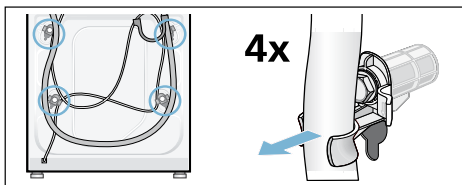

2. Unscrew and remove all four transport brace screws. Remove the sleeves. To do this, remove the mains cable from the holders.

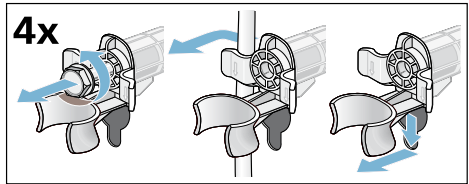

3. Insert the covers. Lock the covers firmly in place by applying pressure to the snap-in hooks.

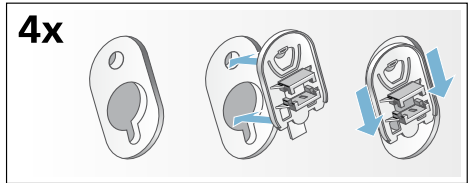

Hose and cable lengths

Connection on left side

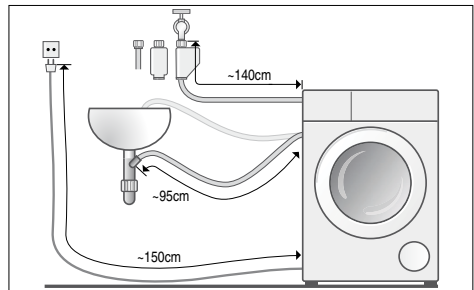

or

Connection on right side

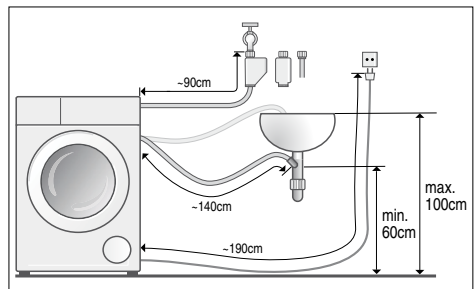

en Positioning and connecting

Note: If the hose holders are used, the possible hose lengths are reduced!

Available from dealer/customer service:

- Extension for Aqua-Stop or cold water inlet hose (approx. 2.50 m). Order no. WMZ 2380, WZ 10130, CZ 11350, Z 7070X0.
- Longer supply hose (approx. 2.20 m), for standard model.

Water inlet

Warning **Danger of death!**

There is a risk of electric shock if you touch live components.

Do not immerse the Aqua-Stop safety valve in water (it contains an electric valve).

Notes

- Only operate the washer dryer using cold mains water.
- Do not connect the machine to the mixer tap of an unpressurised hot-water boiler.
- Do not use a used supply hose. Only use the supply hose supplied or one that was purchased from an authorised specialist retailer.
- Do not kink or squash the water supply hose.
- Do not alter (shorten, cut through) the water supply hose (otherwise its strength is no longer guaranteed).
- Only tighten the screw connections by hand. If the screw connections are tightened too much with a tool (pliers), the thread may become damaged.

Optimum water pressure in the supply network

At least 100 kPa (1 bar)

Maximum 1000 kPa (10 bar)

When the tap is open, the water flow rate is at least 8 l/min.

If the water pressure is higher than this, a pressure-reducing valve must be installed.

Connection

Connect the water supply hose to the tap (26.4 mm = 3/4") and to the appliance (not necessary for Aqua-Stop models as this is permanently installed):

- Model: **Standard**

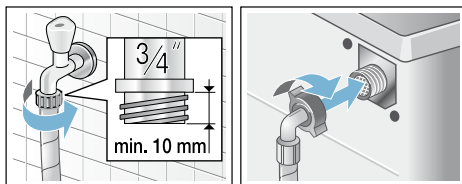

- Model: **Aqua-Secure**

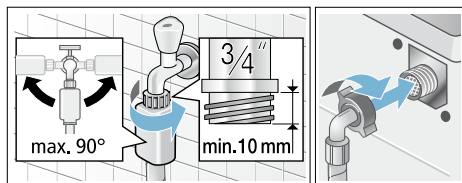

- Model: **Aqua-Stop**

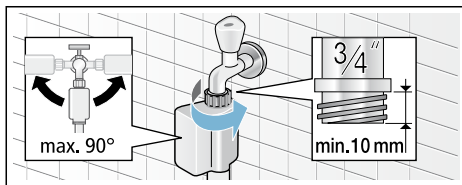

Note: Turn on the tap carefully, checking the leak tightness of the connection points. The screw connection is under mains water pressure.

Water outlet

Warning **Risk of scalding!**

When you are washing at high temperatures, there is a risk of scalding

if you come into contact with hot water (e.g. when draining hot water into a washbasin).
Do not reach into the hot water.

Caution!
Water damage

If the drain hose slips out of the washbasin or the connection point during draining due to high water pressure, any escaping water may cause water damage.
Secure the drain hose so that it cannot slip out.

Caution!
Damage to the appliance/fabrics

If the end of the drain hose is immersed in the drained water, water may be sucked back into the appliance and may damage the appliance/fabrics.
Make sure that:

- The plug does not block drainage from the washbasin.
- The end of the drain hose is not immersed in the drained water.
- The water drains away quickly enough.

Note: Do not kink the water drain hose or put strain on it lengthways.

Connection

■ **Drainage into a washbasin**

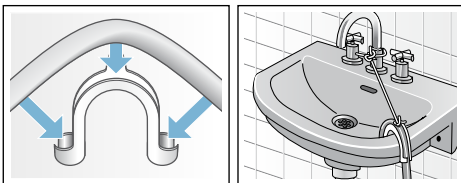

- **Drainage into a siphon**
The connection point must be secured using a hose clamp with a diameter of 24 - 40 mm (available from specialist dealers).

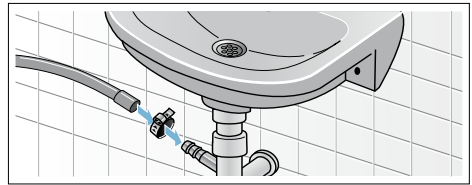

- **Drainage into a plastic pipe with rubber bushing or into a drainage pit**

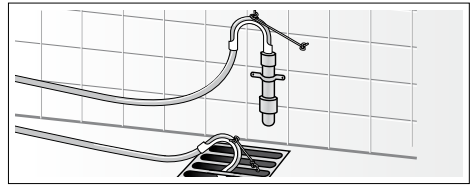

Alignment

1. Loosen the lock nut in a clockwise direction with a wrench.
2. Check the alignment of the washer dryer with a spirit level and, if required, correct. Adjust the height by rotating the appliance foot.

Note: All four appliance feet must be firmly on the floor.
The washer dryer must not wobble!

3. Tighten the lock nut against the housing.
Grip the foot and do not adjust the height.

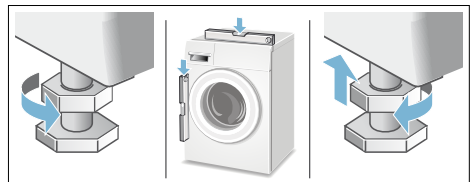

Notes

- The lock nuts on all four appliance feet must be screwed tightly against the housing!
- Any loud noises, intense vibrations or "wandering" may be due to incorrect alignment!

Electrical connection

Electrical safety



Warning

Risk of electric shock!

Danger of death if live parts are touched.

- When disconnecting the main plug, always pull the plug itself and not the cable, otherwise the cable could be damaged.
- Never touch or hold the mains plug with wet hands.
- Never pull out the mains plug during operation.
- Only connect the washer dryer to an alternating current using a correctly installed earthed socket.
- The mains voltage must be the same as the voltage specifications on the washer dryer (appliance rating plate).
- The connected load and the required fuse are also indicated on the appliance rating plate.

Ensure that:

- The mains plug and socket match.
- The cable cross-section is adequate.
- The earthing system has been installed correctly.
- A damaged power cord is only replaced by an electrician. A replacement mains cable can be obtained from customer service.
- You do not use multiple plugs/couplings or extension cables.
- If a residual-current-operated circuit breaker is used, you use only a type which features this symbol: . Only this symbol guarantees compliance with the currently valid regulations.
- The mains plug is always accessible.
- The power cord is not kinked, crushed, altered or severed and has not come into contact with any heat sources.

Before washing/drying for the first time

The washer dryer was inspected thoroughly before leaving the factory. To remove any residual test water, run the **Drum Clean** programme the first time **without** laundry.

Note:

- The washer dryer must have been installed and connected properly. Installation and connection → *Page 37*
- Never switch on a damaged washer dryer. Inform your customer service. → *Page 35*

1. Insert mains plug.
2. Turn the tap on.
3. Switch on the appliance.
4. Close the door. Do not load any laundry.
5. Select the **Drum Clean 40°C** programme.
6. Open the detergent drawer.
7. Pour approx. 1 litre of water into dispenser **II**.
8. Add standard detergent to dispenser **II** according to manufacturer's instructions for light soiling.
Note: To prevent frothing, use only half the recommended amount of detergent. Do not use any woollens or mild detergents.
9. Close the detergent drawer.
10. Select  **Start/Reload**.
11. When the programme ends, switch off the appliance.

Your washer dryer is now ready for use.

Transportation

Preparatory work

1. Turn off the tap.
2. Release the water pressure in the supply hose.
Filter in the water inlet hose blocked
→ *Page 30*
3. Drain any residual washing water.
Drain pump blocked → *Page 29*
4. Disconnect the washer dryer from the power supply.
5. Remove the hoses.

Installing transportation protection devices:

1. Remove the covers and keep in a safe place.
If required, use a screwdriver.

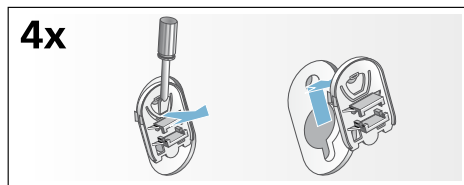

2. Insert all 4 sleeves.
Clamp the mains cable on the holders. Insert and tighten the bolts.

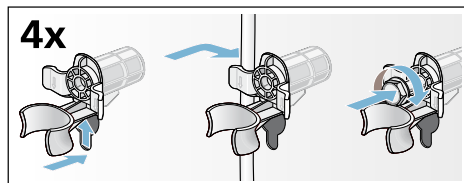

Before switching on the appliance:

Notes

- **Always** remove the transportation protection devices!
- To prevent unused detergent from flowing into the outlet during the next wash: Pour 1 litre of water into dispenser **II** and start the **Spin/Drain**  programme.



Thank you for buying a Bosch Home Appliance!

Register your new device on MyBosch now and profit directly from:

- **Expert tips & tricks for your appliance**
- **Warranty extension options**
- **Discounts for accessories & spare-parts**
- **Digital manual and all appliance data at hand**
- **Easy access to Bosch Home Appliances Service**

Free and easy registration – also on mobile phones:

www.bosch-home.com/welcome



Looking for help? You'll find it here.

Expert advice for your Bosch home appliances, help with problems or a repair from Bosch experts.

Find out everything about the many ways Bosch can support you:

www.bosch-home.com/service

Contact data of all countries are listed in the attached service directory.

BSH Hausgeräte GmbH

Carl-Wery-Straße 34

81739 München, GERMANY

A Bosch Company



9001284766 (021210)

en