



Register your new Bosch now:
www.bosch-home.com/welcome



Washing machine
WAWH8660GB



BOSCH

en Instruction Manual and Installation Instructions

Your new washing machine

You have chosen a Bosch washing machine.

Please take a few minutes to read and become familiar with the advantages of your washing machine.

To meet the high quality demands required by Bosch, every washing machine that leaves our factory is carefully checked to ensure that it functions correctly and is in perfect condition.

For more information on our products, accessories, replacement parts and services, see our website www.bosch-home.com or contact our after-sales service centres.

If the operating and installation instructions describe different models, any differences will be pointed out at the relevant points in the text.



Read these operating and installation instructions before switching on the washing machine.

Display rules

Warning!

This combination of symbol and signal word indicates a possibly dangerous situation. Not heeding the warning can cause death or injuries.

Caution!

This signal word indicates a possibly dangerous situation. Not heeding the caution can cause property and/or environmental damage.

Note/tip

Information about the optimum use of the appliance/any other useful information.

1. 2. 3. / a) b) c)











The steps are represented by numbers or letters.

■ / -

Lists are represented by a small box or a dash.

Contents

	Intended use	5		Detergent	30
	Safety instructions	6		Correct selection of detergent	30
	Children/people/pets	6		Saving energy and detergent	30
	Installation	7		Overview of programmes	31
	Operation	10		Programmes on the programme	
	Cleaning/Maintenance	11		selector	31
	Environmental protection	13		Starching	36
	Packaging/used appliance	13		Dyeing/bleaching	36
	Tips on economical use	13		Soaking	36
	Positioning and connecting	14		Programme default settings	37
	Included with the appliance	14		Temperature	37
	Safety instructions	14		Spin speed	37
	Installation surface	15		Finished In	37
	Installation on a base			i-DOS settings	38
	or a wooden joist floor	15		Additional programme	
	Installation on a platform with drawer	15		settings	38
	Installing the appliance			SpeedPerfect	38
	in a kitchenette	15		EcoPerfect	38
	Removing the transport locks	16		Prewash	39
	Hose and cable lengths	17		Aqua Plus	39
	Water inlet	18		Operating the appliance	39
	Water outlet	19		Preparing the washing machine	39
	Levelling	20		Switching on the appliance/ selecting a programme	39
	Electrical connection	20		Placing laundry into the drum	40
	Before washing for the first time	21		Measure and add detergent and care products	40
	Transportation	22		Change the programme default settings	40
	Main points in brief	23		Select additional programme settings	41
	Getting to know the appliance	24		Start the programme	41
	Washing machine	24		Child Lock 3 sec.	41
	Control panel	25		Adding laundry	42
	Display panel	27		Changing the programme	42
	Laundry	29		Cancel the programme	42
	Prepare the laundry	29		Programme end during rinse hold	42
	Sorting laundry	29		Programme end	42
				Removing laundry/ switching off the appliance	42

 Intelligent dosing system	43
Intelligent dosing system in the detergent drawer	43
Initial use/filling the dispensers	43
Everyday use	44
Basic settings	45
Manual dosage	46
 Home Connect	47
Connecting to your home network automatically	48
Connecting to your home network manually	49
Connecting to the Home Connect app	50
Activating or deactivating Wi-Fi	51
Resetting your network settings	52
Updating the software	53
About data protection	53
Declaration of Conformity	53
 Appliance settings	54
Activating the setting mode	54
Changing the signal volume	54
Selecting/deselecting the appliance automatic switch-off	54
Switching the drum-care information signal on/off	54
Exiting setting mode	55
 Sensors	55
Automatic load sensing	55
Unbalanced load detection system	55
AquaSensor	55
 Cleaning and maintenance	55
Machine housing/control panel	56
Drum	56
Descaling	56
i-DOS detergent draw and its housing	56
The drain pump is blocked, emergency draining	58
The drain hose at the siphon is blocked	58
Filter in the water supply blocked	59
 Faults and what to do about them	60
Emergency release	60
Information on the display panel	61
Faults and what to do about them	62
 After-sales service	64
 Consumption rates	65
Energy and water consumption, programme duration and residual moisture for the main washing programmes	65
Efficiency test programmes for cotton fabrics	66
 Technical data	66
 Aqua-Stop warranty	67



Intended use

- This appliance is intended for private domestic use only.
- Do not install or operate this appliance anywhere that is liable to experience frost and/or outdoor conditions. There is a risk that the appliance will be damaged if residual water in it freezes. If hoses freeze up, they may crack/burst.
- This appliance must only be used for washing domestic laundry, consisting of machine-washable items and hand-washable woollens (see label on item). Using the appliance for any other purpose is outside of the scope of its intended application and is forbidden.
- This appliance is suitable for operation with mains water and commercially available detergents and care products (must be suitable for use in washing machines).
- This appliance is intended for use up to a maximum height of 4000 metres above sea level.

Before you switch on the appliance:

Check that there is no visible damage to the appliance. Do not operate the appliance if it is damaged. Should you have any problems, please contact your specialist dealer or our customer service.

Read and follow the operating and installation instructions and all other information provided with this appliance.

Retain the documents for subsequent use or for subsequent owners.

Safety instructions

The following safety information and warnings are provided to protect you from injury and to prevent material damage to your surroundings.

It is nevertheless important to take the necessary precautions and to proceed with care when installing, maintaining, cleaning and operating the appliance.

Children/people/pets

Warning **Risk of death!**

Children and other people who are unable to assess the risks involved when using the appliance may injure themselves or may find themselves in life-threatening situations. Therefore please note:

- The appliance may be used by children over the age of 8 years and by persons with reduced physical, sensory or mental capacity or by persons with a lack of experience or knowledge as long as they are supervised or have received instruction on how to use the appliance safely and they have understood the potential risks of using the appliance.
- Children must not play with this appliance.

- Do not allow children to clean or maintain this appliance unsupervised.
- Keep children under 3 years and pets away from this appliance.
- Do not leave the appliance unattended when children or other people who are unable to assess the risks are in the vicinity.

Warning **Risk of death!**

Children may lock themselves inside appliances and find themselves in a life-threatening situation.

- Do not position the appliance behind a door, as this may obstruct the appliance door or prevent it from opening completely.
- Once an appliance has reached the end of its life, pull the mains plug from the socket **before** severing the mains cable, and then destroy the lock on the appliance door.

⚠ Warning**Risk of suffocation!**

If allowed to play with the packaging/plastic film or packing components, children may become caught in these or pull them over their heads and suffocate.

Keep packaging, plastic film and packing components away from children.

⚠ Warning**Risk of poisoning!**

Detergents and care products may result in poisoning if consumed.

If accidentally swallowed, seek medical advice. Keep detergents and care products out of the reach of children.

⚠ Warning**Risk of burns!**

When washing at high temperatures, the glass in the appliance door becomes hot. Stop children from touching the appliance door when it is hot.

⚠ Warning**Eye/skin irritation!**

Contact with detergents or care products may cause eye/skin irritation.

Rinse eyes/skin thoroughly if they/it come(s) into contact with detergents or care products. Keep detergents and care products out of the reach of children.

Installation**⚠ Warning****Risk of electric shock/fire/material damage/damage to the appliance!**

If the appliance is not installed properly, this may lead to a dangerous situation. Make sure that:

- The mains voltage on your power socket matches the rated voltage specified on the appliance (identification plate). The connected loads and the required fuse protection are specified on the identification plate.
- The appliance is only connected to a source of alternating current via a nationally recognized and grounded outlet that has been correctly installed.
- The mains plug and the grounded socket match and the earthing system has been correctly installed.
- The cross section of the cable is sufficiently large enough.
- The mains plug is accessible at all times.
- If using a residual current circuit breaker, only use one that bears the following mark: . The presence of this mark is the only way to be sure that it fulfils all the applicable regulations.

⚠ Warning

**Risk of electric shock/fire/
material damage/damage to
the appliance!**

If the appliance's mains cable is altered or damaged, this may result in electric shock, short circuiting or fire due to overheating.

The mains cable must not be kinked, crushed or altered, and must not come into contact with any heat sources.

⚠ Warning

**Risk of fire/material damage/
damage to the appliance!**

The use of extension cords or power strips may result in fire due to overheating or short circuiting.

Connect the appliance directly to an earthed socket that has been correctly installed. Do not use extension cords, power strips or multi-way couplers.

⚠ Warning

**Risk of injury/material
damage/damage to the
appliance!**

- The appliance may vibrate or move when in operation, potentially resulting in injury or material damage.
Place the appliance on a clean, even, solid surface and, using a spirit level to guide you, level it with the screw-in feet.

- If you take hold of any of the appliance's protruding parts (e.g. the appliance door) in order to lift or move it, these parts may break off and cause injury.

Do not take hold of any of the appliance's protruding parts in order to move the appliance.

⚠ Warning

Risk of injury!

- The appliance is very heavy. Lifting it may result in injury. Do not lift the appliance on your own.
- The appliance has sharp edges on which you could cut your hands. Do not take hold of the appliance by its sharp edges. Wear protective gloves to lift it.
- If the hoses and mains cables are not correctly routed, they may constitute a tripping hazard, which may result in injury. Route hoses and cables such that they do not constitute a tripping hazard.

Caution!**Material damage/damage to the appliance**

- If the water pressure is too high or too low, the appliance may not be able to operate properly, and it may also result in material damage or damage to the appliance.
Make sure that the water pressure in the water supply facility is at least 100 kPa (1 bar), and does not exceed 1000 kPa (10 bar).
- If the water hoses are altered or damaged, this may result in material damage or damage to the appliance. The water hoses must not be kinked, crushed, altered or severed.
- The use of hoses supplied by other brands to connect to the water supply may result in material damage or damage to the appliance. Use the hoses supplied with the appliance or genuine spare part hoses only.
- The appliance is secured for transportation by transport locking devices. If the transport locking devices are not removed before the appliance is operated, this may result in damage to the appliance.
It is important to completely remove all transport locking devices before using the appliance for the first time. Make sure that you retain these transport locking devices separately. It is important to refit the transport locking devices if the appliance is to be transported, in order to prevent the appliance from being damaged in transit.

Operation

Warning

Risk of explosions/fire!

Laundry that has been pretreated with cleaning agents that contain solvents, e.g. stain remover/cleaning solvent, may cause an explosion in the drum. Rinse the laundry thoroughly with water before washing it in the machine.

Warning

Risk of poisoning!

Poisonous fumes may be given off by cleaning agents that contain solvents, e.g. cleaning solvent.

Do not use cleaning agents that contain solvents.

Warning

Risk of injury!

- If you support your weight/sit on the appliance door when it is open, the appliance may tip over, which may result in injury.

Do not support your weight on the appliance door when it is open.

- If you climb onto the appliance, the worktop may break, which may result in injury.

Do not climb onto the appliance.

- If you reach into the drum while it is still rotating, you risk injuring your hands. Wait until the drum has stopped rotating.

Warning

Risk of scalding!

When washing at high temperatures, there is a risk of scalding if you come into contact with hot detergent solution (e.g. when draining hot detergent solution into a washbasin).

Do not reach into the hot detergent solution.

Warning

Eye/skin irritation!

Detergent and care products may spray out if the detergent drawer is opened while the appliance is in operation.

Rinse eyes/skin thoroughly if they/it come(s) into contact with detergents or care products. If accidentally swallowed, seek medical advice.

Caution!**Material damage/damage to the appliance**

- If the amount of laundry in the appliance exceeds its maximum load capacity, it may not be able to operate properly, or this may result in material damage or damage to the appliance.
Do not exceed the maximum load capacity of dry laundry. Make sure you comply with the maximum load capacities specified for each of the programs. → *Page 31*
- If you pour the wrong quantity of detergent or cleaning agent into the appliance, this may result in material damage or damage to the appliance.
Use detergents/care products/cleaning agents and softeners in accordance with the manufacturers' instructions.

Cleaning/Maintenance

 **Warning**
Risk of death!

The appliance is powered by electricity. There is a risk of electric shock if you come into contact with live components. Therefore please note:

- Switch off the appliance. Disconnect the appliance from the power supply (pull out the plug).
- Never take hold of the mains plug with wet hands.
- When removing the mains plug from the socket, always take hold of the plug itself and never the mains cable, otherwise this may damage the mains cable.
- Do not make any technical modifications to the appliance or its features.
- Repairs and any other work on the appliance must only be conducted by our customer service or by an electrician. The same applies for replacing the mains cable (when necessary).
- Spare mains cables can be ordered from our customer service.

 **Warning**

Risk of poisoning!

Poisonous fumes may be given off by cleaning agents that contain solvents, e.g. cleaning solvent.

Do not use cleaning agents that contain solvents.

 **Warning**

Risk of electric shock/material damage/damage to the appliance!

If moisture penetrates the appliance, this may cause it to short circuit.

Do not use a pressure washer or steam cleaner to clean your appliance.

 **Warning**

Risk of injury/material damage/damage to the appliance!

The use of spare parts and accessories supplied by other brands is dangerous and may result in injury, material damage or damage to the appliance.

For safety reasons, use genuine spare parts and accessories only.

Caution!

Material damage/damage to the appliance

Cleaning agents and agents for pretreating laundry (e.g. stain removers, prewash sprays, etc.) may cause damage if they come into contact with the surfaces of the appliance. Therefore please note:

- Do not allow these agents to come into contact with the surfaces of the appliance.
- Clean the appliance with nothing but water and a soft, damp cloth.
- Remove any detergent, spray or other residues immediately.



Environmental protection

Packaging/used appliance



Dispose of packaging in an environmentally-responsible manner.

This appliance is labelled in accordance with European Directive 2012/19/EU concerning used electrical and electronic appliances (waste electrical and electronic equipment - WEEE).

The guideline determines the framework for the return and recycling of used appliances as applicable throughout the EU.

Tips on economical use

- Always fill the appliance with the maximum amount of laundry for the relevant programme.
Overview of programmes
→ *Page 31*
 - Wash normally soiled laundry without a prewash.
 - Save energy and detergent when washing lightly and normally soiled laundry. → *Page 30*
 - Using the **intelligent dosing system** (i-DOS) to dose your detergent helps you to save detergent and use less water.
 - The selectable temperatures apply to the care labels on the textiles. The temperatures in the machine may deviate from this so that you get the optimum mix of energy-saving and washing results.
- **Information on energy and water consumption:** → *Page 27*
The displays provide information about the relative level of energy and water consumption in the selected programmes.
The more indicator lights light up, the higher the programme's consumption.
This enables you to compare the consumption levels of the different programmes when choosing your programme settings and decide on an energy- and water-saving programme setting.
 - **Energy-saving mode:** The display panel lighting goes out after a few minutes and the  button flashes. Press any button to activate the lighting.
Energy-saving mode is not activated if a programme is running.
 - **Automatic switch off:** If the appliance is not operated for a prolonged period, it may automatically switch off before the programme starts and when the programme has ended to save energy. Press the main switch again to switch on the appliance. Switching the → *Page 54* function on/off
 - If the laundry is subsequently dried in a tumble dryer, select the spin speed according to the tumble dryer manufacturer's instructions.



Positioning and connecting

Included with the appliance

Note: Check the machine for transport damage. Never use a damaged machine. If you have any complaints, contact the dealer from whom you purchased the appliance or our customer services. → Page 64

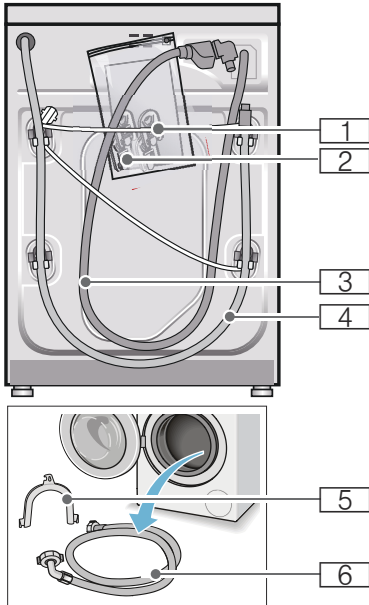

- 1 Mains cable
 - 2 Bag:
 - Installation and operating instructions
 - Customer services location directory*
 - Warranty*
 - Cover caps for openings after the transport braces have been removed
 - Adaptor with sealing washer from 21 mm = 1/2" to 26.4 mm = 3/4" *
 - 3 Water supply hose on Aqua-Stop models
 - 4 Water drain hose
 - 5 Elbow for securing the water drain hose*
 - 6 Water supply hose on standard/ Aqua-Secure models
- * depending on the model

In addition, a hose clamp (24 - 40 mm diameter, available from specialist dealers) is required to connect the water drain hose to a siphon.

Useful tools

- Spirit level for aligning
- Spanner with:
 - WAF13 for loosening the transport braces, and
 - WAF17 for aligning the appliance feet

Safety instructions



Warning Risk of injury!

- The washing machine is very heavy. Be careful when lifting/transporting the washing machine.

- When the washing machine is lifted by its protruding parts (e.g. the washing machine door), the components may break off and cause injuries.
Do not lift the washing machine by protruding parts.
- If the hose and mains cables are not routed properly, there is a risk of tripping and injury.
Lay hoses and cables in such a way that there is no risk of tripping.

Caution!**Damage to the appliance**

Frozen hoses may rip/burst.
Do not install the washing machine in areas exposed to frost or outdoors.

Caution!**Water damage**

The connection points for the water supply hose and water drain hose are under high water pressure. To prevent leaks and water damage, you must follow the instructions in this section.

Notes

- In addition to the safety information listed here, the local water and electricity supplier may have special requirements.
- If in doubt, have the appliance connected by a specialist.

Installation surface

Note: The washing machine be stable so that it does not move around.

- The installation surface must be firm and level.
- Soft floors/floor coverings are not suitable.

Installation on a base or a wooden joist floor**Caution!****Damage to the appliance**

The washing machine may "wander" and tip/topple from the base when spinning.

The feet of the appliance must be secured with holding brackets.
Order no. WMZ 2200, WX 9756, Z 7080X0

Note: On wooden joist floors, install the washing machine:

- In a corner, if possible,
- On a water-resistant wooden board (min. 30 mm thick) which is screwed tightly to the floor.

Installation on a platform with drawer

Platform order no.: WMZ 20490, WZ 20490, WZ 20510, WZ 20520

Installing the appliance in a kitchenette** Warning****Danger of death!**

There is a risk of electric shock if you touch live components.
Do not remove the appliance covering plate.

Notes

- Recess width of 60 cm required.
- Only install the washing machine underneath a continuous worktop that is securely connected to adjacent cabinets.

Removing the transport locks

Caution!

Damage to the appliance

- The machine is secured for transportation using transport locks. If the transport locks are not removed, the drum, for example, may become damaged when the machine is operated. Before using the appliance for the first time, make sure that you completely remove all four transport locks. Keep the locks in a safe place.
- To prevent transport damage from occurring if the appliance is moved at a later date, you must refit the transport locks before transporting the appliance.

Note: Keep the screws and sleeves in a safe place.

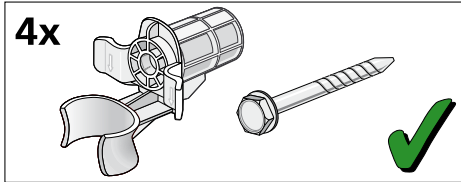

1. Take the hoses out of the holders.

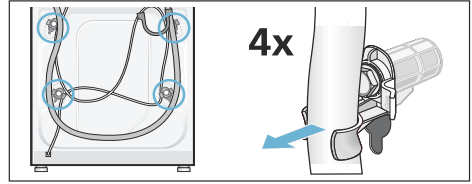

2. Unscrew and remove all four transportation securing bolts with a wrench (WAF 13). Remove the sleeves. Remove the mains cable from the holders.

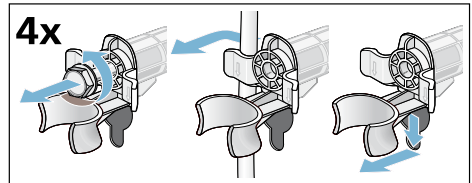

3. Insert the covers. Lock the covers firmly in place by applying pressure to the snap-in hooks.

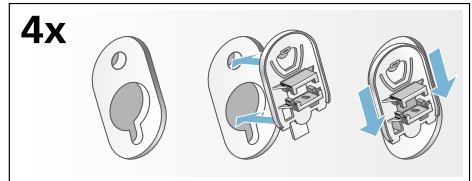

Hose and cable lengths

■ Left-hand connection

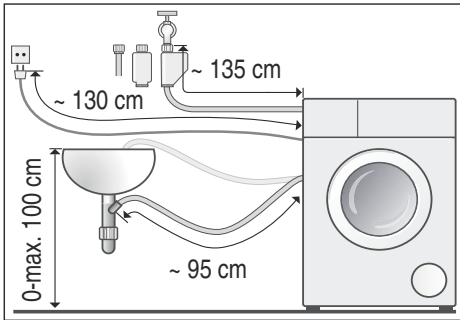

■ Right-hand connection

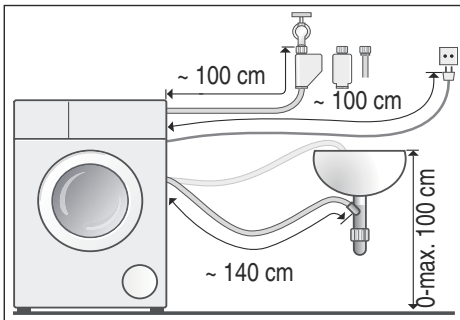

Tip: The following are available from specialist dealers/customer services:

- Extension for Aqua-Stop and cold water supply hose (approx. 2.50 m); order no. WM Z2380, WZ 10130, CZ 11350, Z 7070X0
- A longer supply hose (approx. 2.20 m) for standard models; individual component number for customer services: 00353925

Water inlet

Warning **Danger of death!**

There is a risk of electric shock if you touch live components. Do not immerse the Aqua-Stop safety valve in water (it contains an electric valve).

Notes

- Only operate the washing machine using cold mains water.
 - Do not connect the machine to the mixer tap of an unpressurised hot-water boiler.
 - Do not use a used supply hose. Only use the supply hose supplied or one that was purchased from an authorised specialist retailer.
 - Do not kink or squash the water supply hose.
 - Do not alter (shorten, cut through) the water supply hose (otherwise its strength is no longer guaranteed).
 - Only tighten the screw connections by hand. If the screw connections are tightened too much with a tool (pliers), the thread may become damaged.
 - When connecting to a 21 mm = 1/2" tap, first fit an adapter* with a sealing washer from 21 mm = 1/2" to 26.4 mm = 3/4".
- *supplied depending on the model

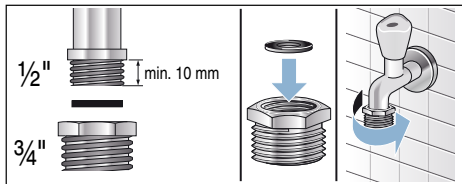

Optimum water pressure in the supply network

At least 100 kPa (1 bar)

Maximum 1000 kPa (10 bar)

When the tap is open, the water flow rate is at least 8 l/min.

If the water pressure is higher than this, a pressure-reducing valve must be installed.

Connection

Connect the water supply hose to the tap (26.4 mm = 3/4") and to the appliance (not necessary for Aqua-Stop models as this is permanently installed):

- Model: **Standard**

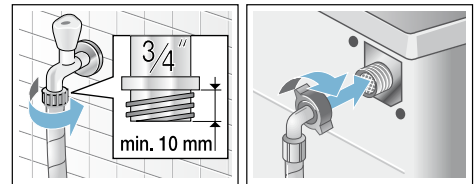

- Model: **Aqua-Secure**

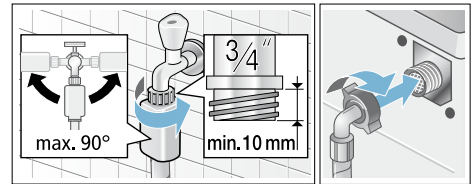

- Model: **Aqua-Stop**

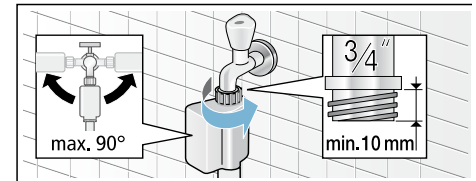

Note: Turn on the tap carefully, checking the leak tightness of the connection points. The screw connection is under mains water pressure.

Water outlet

Warning

Risk of scalding!

When you are washing at high temperatures, there is a risk of scalding if you come into contact with hot water (e.g. when draining hot water into a washbasin).

Do not reach into the hot water.

Caution!

Water damage

If the drain hose slips out of the washbasin or the connection point during draining due to high water pressure, any escaping water may cause water damage.

Secure the drain hose so that it cannot slip out.

Caution!

Damage to the appliance/fabrics

If the end of the drain hose is immersed in the drained water, water may be sucked back into the appliance and may damage the appliance/fabrics.

Make sure that:

- The plug does not block drainage from the washbasin.
- The end of the drain hose is not immersed in the drained water.
- The water drains away quickly enough.

Note: Do not kink the water drain hose or put strain on it lengthways.

Connection

■ Drainage into a washbasin

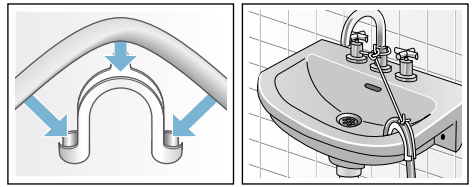

■ Drainage into a siphon

The connection point must be secured using a hose clamp with a diameter of 24 - 40 mm (available from specialist dealers).

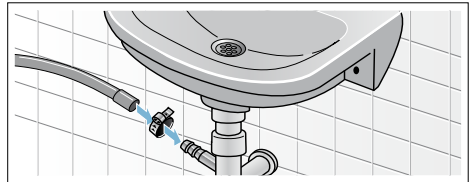

■ Drainage into a plastic pipe with rubber bushing or into a drainage pit

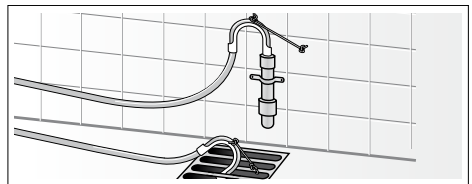

Levelling

Align the appliance using a spirit level.

Incorrect alignment may result in loud noises, vibrations and machine "movement".

1. Loosen the lock nuts using a WAF17 spanner, by turning it in a clockwise direction.
2. Check the alignment of the washing machine with a spirit level, and adjust it if necessary. Change the height by turning the appliance feet. All four appliance feet must stand firmly on the ground.
3. The lock nuts on all four appliance feet must be screwed tightly against the housing using a suitable WAF17 spanner. In doing so, hold the foot tight and do not adjust its height.



Electrical connection

Warning **Danger of death!**

There is a risk of electric shock if you touch live components.

- Never touch or hold the mains plug with wet hands.
- Only pull out the mains cable by the plug and never by the cable, as this could damage it.
- Never unplug the mains plug during operation.

Observe the following information and ensure that:

Notes

- The mains voltage and voltage indicated on the washing machine (rating plate) are the same. The connected load and fuse required are specified on the rating plate.
- The washing machine is only connected to an alternating current supply via a properly installed earthed socket.
- The mains plug fits the socket.
- The cable cross-section is adequate.
- The earthing system is properly installed.
- The mains cable is only replaced by a qualified electrician (if this is necessary). Replacement mains cables are available from customer services.
- No multiple plugs/couplings or extension cables are used.
- If an earth-leakage circuit breaker is used, only a type which displays the  symbol is used. Only this symbol guarantees compliance with the currently applicable regulations.
- The mains plug can be accessed at all times.
- The mains cable is not kinked, squashed, altered or cut through.
- The mains cable does not come into contact with heat sources.



Before washing for the first time

The washing machine was thoroughly tested before leaving the factory. To remove any water that may be left over from the test, run the first wash cycle **without** any laundry.





Notes

- The washing machine **must be correctly installed and connected.** (from → *Page 14*)
- Never use a damaged machine. Inform the after-sales service.

Preparatory work:

1. Check the machine.
2. Fill the dispenser  and .
→ *Page 43*
3. Remove the protective film from the control panel.
4. Plug into the mains.
5. Turn on the tap.

Run the programme without laundry:

1. Switch on the appliance.
 2. Close the door (do not load any laundry).
 3. Set the **Drum Clean 90 °C** programme.
 4. Open the detergent drawer.
 5. Pour approx. 1 litre of water into compartment  .
 6. Pour standard washing powder into compartment  .
- Note:** To prevent foaming, only use half of the amount of detergent recommended by the detergent manufacturer. Do not use detergents that are intended for wool or delicates.
7. Close the detergent drawer.
 8. Press the  button.
 9. Switch off the appliance at the end of the programme.

Your washing machine is now ready to use.

Transportation

E.g. when moving house

Caution!

Risk of damage to the appliance caused by detergent/fabric softener leaking from the dispensers.

Leaking detergent/fabric softener can prevent the appliance from working correctly, e.g. due to damage to the electronics.

Empty the dispensers before transporting the appliance.

Preparatory work:

1. Turn off the tap.
2. Reduce the water pressure in the supply hose: → Page 59; cleaning and maintenance – filter in the water supply clogged
3. Disconnect the washing machine from the mains.
4. Drain any residual water: → Page 58; cleaning and maintenance – drain pump blocked, emergency draining
5. Remove the hoses.
6. Empty the dispensers. → Page 56

Fitting the transportation securing means:

1. Remove the covers and keep them in a safe place.
If required, use a screwdriver.

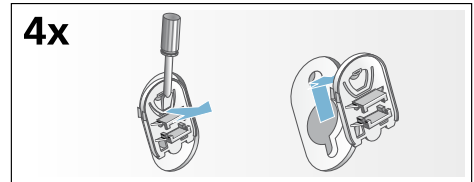

2. Insert all four sleeves.
Clip the mains cable securely in the holders. Insert the transportation securing bolts and tighten them with a wrench (WAF 13).

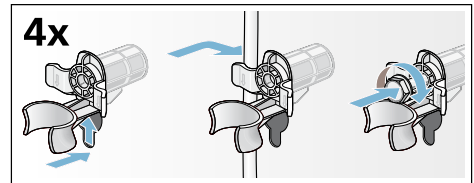

Before switching on the appliance again:

Notes

- **Always** remove the transport braces.
- To prevent unused detergent from flowing straight into the drain during the next wash: Pour approx. 1 litre of water into compartment  and start the **Drain** programme.



Main points in brief

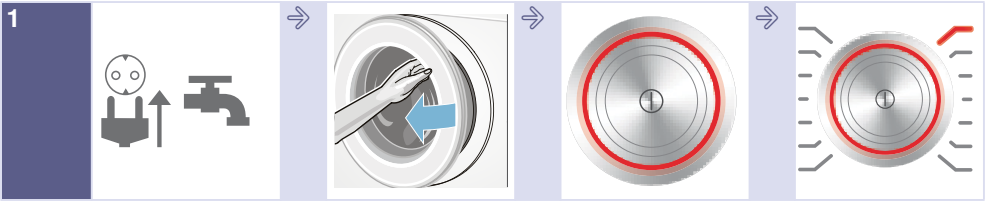

1

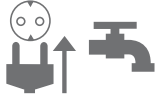

Connect the mains plug. Turn on the tap.

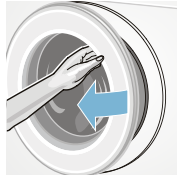

Open the door.



To switch on, press the  button.



Select a programme, e.g. **Cottons**.



2



Sort the laundry.



Observe the maximum load (depending on the model) on the display panel.

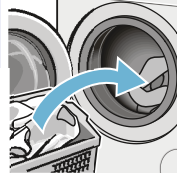

Load the laundry.



Close the door.



3

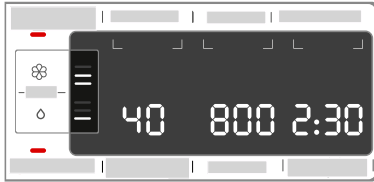

If necessary, change the default programme settings and/or select additional settings.



Start the programme.

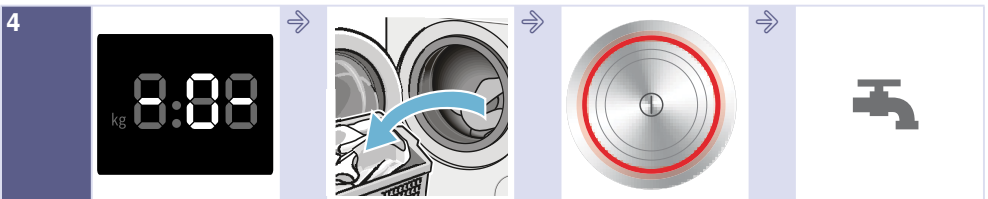

4



End of the programme



Open the door and remove the laundry.



To switch off, press the  button.



Turn off the tap (for models without Aqua-Stop).

Getting to know the appliance

Washing machine

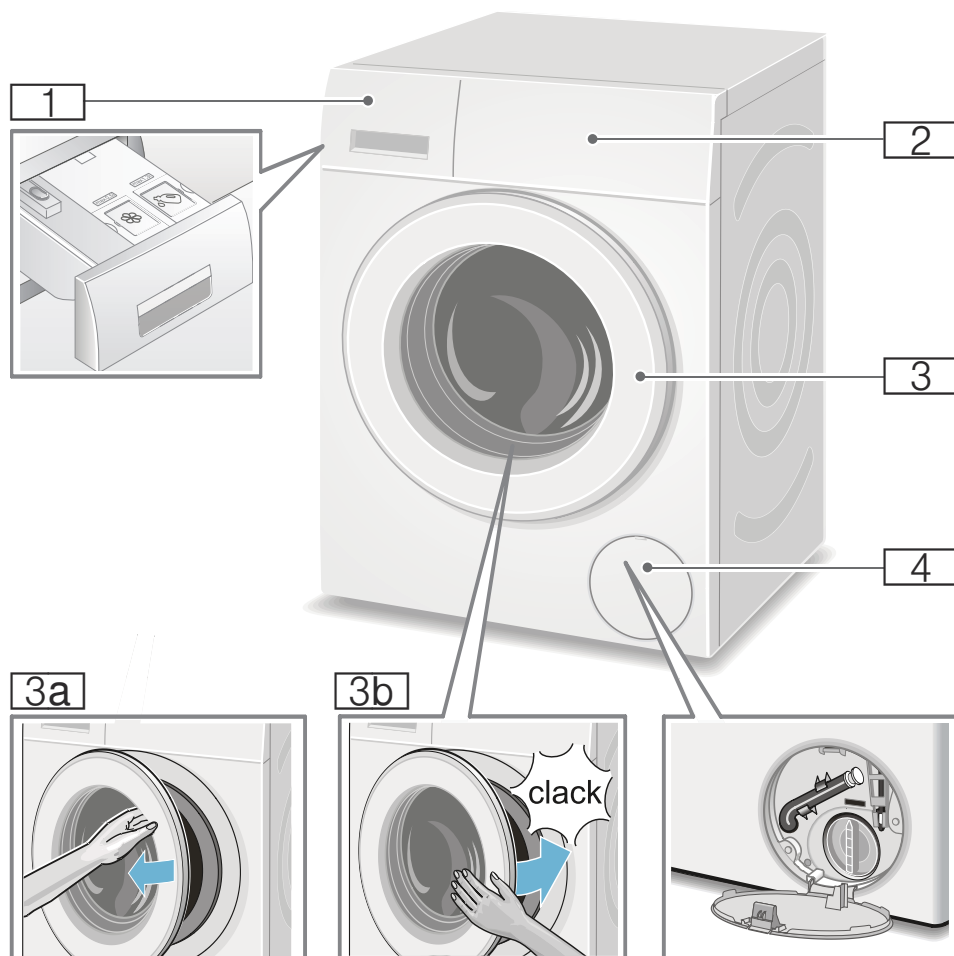

- 1** Detergent drawer → *Page 40*
- 2** Operating/display panel
- 3** Door with door handle
- 3a** Open the door
- 3b** Close the door
- 4** Service flap

Control panel

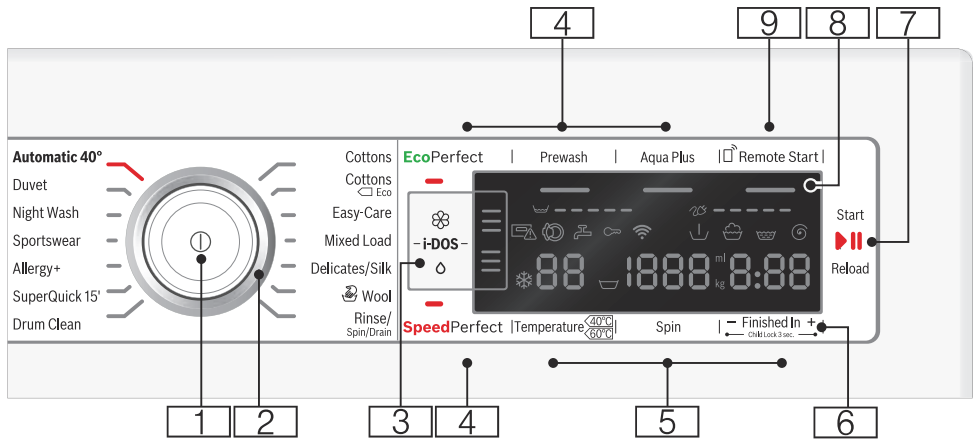

Note: All the buttons are sensitive (except for the main switch) and only need to be pressed lightly.

1 Main switch

To switch the washing machine on and off:
Press the ① button.

2 Programme selector

To select a programme:
Programme overview → Page 31

3 i-DOS settings → Page 43

4 Additional programme settings: → Page 38

- SpeedPerfect,
- EcoPerfect,
- Prewash (↓),
- Aqua Plus (☼),

5 Changing the default programme settings: → Page 37

- Temperature,
- Spin speed (Spin),
- Finished In time

6 Child Lock 3 sec. (∞)

Activate/deactivate to prevent the set functions from being changed accidentally:

To do this, press the **Finished In +** and **-** buttons at the same time for approximately 3 seconds. → Page 41

7 D button for:

- Starting a programme,
- Interrupting a programme, e.g. to add items of laundry → Page 42,
- Cancelling a programme → Page 42

8 Display panel for settings and information. → Page 27

en Getting to know the appliance

- 9 The **Remote Start**  button enables the programme to be started remotely on the appliance via the Home Connect app. Remote start remains enabled for 24 hours after it has been activated. It is automatically deactivated if you do not start the programme via the Home Connect app during this time. If you carry out any operations on the appliance itself, such as opening the door or selecting a different programme, the remote start button will be deactivated for safety reasons.

Notes

- Remote start can only be activated if the door is closed.
- Remote start cannot be activated if the childproof lock is on.

Press and hold the button for more than 3 seconds to access the Home Connect settings.

Display panel

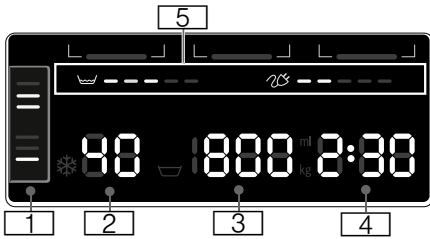

Default programme settings:

1 i-DOS settings

- **Detergent:**
 - ☐ For lightly soiled laundry,
 - ☐☐ For laundry with a normal degree of soiling,
 - ☐☐☐ For heavily soiled laundry
→ *Page 38*
- **Fabric softener:**
 - ☐☐ For slightly soft laundry,
 - ☐☐☐ For medium soft laundry,
 - ☐☐☐☐ For very soft laundry
→ *Page 38*
- Automatic dosage deselected
- ☐☐☐ flashing; the fill level of the container in question has dropped below the minimum permitted level,
Filling → *Page 43*

2 Temperature in °C

- * - 90 (* = cold)

3 Spin speed in rpm,

- ☐, 0 - 1600*;
* Max. spin speed, depending on the selected programme and model,
- 0 = no spin cycle, draining only
→ *Page 37*,
- ☐☐ = Rinse Stop → *Page 37*

4 Finished In time

e.g. 2:30;
Programme duration depends on the programme selection in h:min (hours:minutes)

■ End time preselection

1 - 24 h;
Programme ends after ... h (h = hours)

■ Basic dosage













ml 10 - 200 → *Page 45*





■ Recommended load

e.g. 9 kg*;
* Depending on the selected programme

5 Information on energy and water consumption: → *Page 13*

- ☐☐☐☐☐☐
Water consumption indicator,
- ☐☐☐☐☐☐
Energy consumption indicator

Further information	
Programme progress:	
	Prewash
	Wash
	Rinse
	Spin
- 0 -	Programme end
	Programme end with Rinse Stop selected
- P -	Pause, e.g. to add laundry
Home Connect:	
 is off	Wi-Fi is switched off and the appliance is not connected to your home network.
 is flashing	The appliance is trying to connect to your home network.
 is continuously lit	Wi-Fi is switched on and the appliance is connected to your home network.
Detergent drawer:	
 is continuously lit	Detergent drawer has been pulled out.
 is flashing	After the programme has started: Detergent drawer not fully pushed in.
Door:	
 is continuously lit	The washing machine door can be opened.
 is flashing	After the programme has started: The door is not closed properly.
Tap:	
 is continuously lit	Tap not turned on, no water pressure

Further information	
 is flashing	Water pressure too low (may increase the programme duration)
Childproof lock: → Page 41	
 is continuously lit	Childproof lock activated
 is flashing	Childproof lock activated, programme selector adjusted
Foam detection function:	
 is continuously lit	→ Page 41
Fault indicator:	
E: --	→ Page 61
Signal setting:	
0 - 4	→ Page 54
Automatic switch-off of the appliance:	
On/Off	→ Page 13, → Page 54

Laundry

Prepare the laundry

Caution!

Damage to the appliance/fabrics

Foreign objects (e.g. coins, paperclips, needles, nails) may damage the laundry or components in the washing machine.

You should therefore note the following tips when preparing your laundry:

- Empty any pockets.

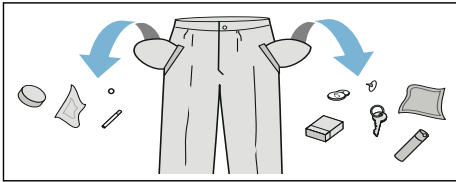

- Look out for metal items (paperclips, etc.) and remove them.
- Wash delicates in a laundry bag (tights, underwired bras, etc.).
- Close any zips; button up any cover buttons.
- Brush sand out of pockets and collars.
- Remove curtain fittings or place curtains in a laundry bag.

Sorting laundry

Sort your laundry according to the care instructions and manufacturer's information on the care labels, depending on:







- Type of fabric/fibre
- Colour
 - Note:** Laundry may discolour. Wash white and coloured items separately. Wash new coloured items separately the first time you wash them.
- Soiling
 - Wash laundry with the same level of soiling together.

Some examples of soiling levels can be found on → *Page 30*

- **Light:** Do not prewash, select the **SpeedPerfect** setting if necessary
- **Normal**
- **Heavy:** Load less laundry, select a programme with prewash
- **Stains:** Remove/pretreat stains while they are fresh. Firstly, dab with soapy water; do not rub. Then wash the items of laundry with the appropriate programme. Stubborn or dried-in stains can sometimes only be removed by washing several times.

- Symbols on the care labels

Note: The numbers in the symbols indicate the maximum washing temperature that may be used.

-  Suitable for normal washing process; e.g. Cottons programme
-  A gentle washing process is required; e.g. Easy-Care programme
-  An especially gentle washing process is required; e.g. Delicate/Silk programme
-  Suitable for washing by hand; e.g.  Woollens programme
-  Do not machine wash.

Detergent

Correct selection of detergent

The care label is crucial for selecting the correct detergent, temperature and treatment of the laundry. → See also www.sartex.ch

If you visit www.cleanright.eu, you will find further information on detergents, care products and cleaning agents for domestic use.

- **Standard detergent with optical brighteners**

Suitable for boil-washable white laundry made from linen or cotton
Programme: Cottons/
cold - max. 90 °C

- **Detergent for colours without bleach or optical brighteners**

Suitable for coloured laundry made from linen or cotton
Programme: Cottons/
cold - max. 60 °C

- **Detergent for colours/delicates without optical brighteners**

Suitable for coloured laundry made from easy-care fibres, synthetic fibres
Programme: Easy-Care/
cold - max. 60 °C

- **Detergent for delicates**

Suitable for delicate, fine fabrics, silk or viscose
Programme: Delicate/Silk/
cold - max. 40 °C

- **Detergent for woollens**

Suitable for wool
Wool programme/
cold - max. 40 °C

Saving energy and detergent

For light and normal soiling, you can save energy (lower washing temperature) and detergent.

Saving	Soiling/note
<p>Reduced temperature and detergent quantity as per the recommended dosage</p>  <p>Temperature as per the care label and detergent quantity as per the recommended dosage for heavy soiling</p>	<p>Light No visible dirt or stains. Clothing has taken on some body odour, e.g.:</p> <ul style="list-style-type: none"> ■ Light summer/sports clothing (worn for a few hours) ■ T-shirts, shirts, blouses (worn for up to one day) ■ Guest bed linen and hand towels (used for one day) <p>Normal Visible dirt or a few light stains, e.g.:</p> <ul style="list-style-type: none"> ■ T-shirts, shirts, blouses (sweat soaked, worn a few times) ■ Towels, bedding (used for up to one week) <p>Heavy Dirt and/or stains clearly visible, e.g. tea towels, baby items, work clothing</p>

Note: When measuring the amount of all detergents/additives/care products and cleaning agents, please always check the manufacturer's instructions and information. → Page 40

Overview of programmes

Programmes on the programme selector

Programme/Type of laundry/Instructions	Settings
<p>Programme name</p> <p>Brief explanation of the programme and the fabrics for which it is suitable.</p>	<p>Max. load</p> <p>Temperature that can be selected (☼ = cold)</p> <p>Spin speed that can be selected^{**}; ▽ = Rinse Stop, 0 = no spin cycle, draining only</p> <p>Additional programme settings that can be selected</p> <p>Automatic dosing can be selected for: Liquid detergent (◊) Fabric softener (⊗) (De)selectable ✓, not selectable -</p>
<p>Cottons</p> <p>Hard-wearing fabrics, heat-resistant fabrics made of cotton or linen</p> <p>Notes</p> <ul style="list-style-type: none"> In the EcoPerfect setting, the washing temperature is lower than the selected temperature. If you want to achieve a particular water temperature, use the programme without the EcoPerfect setting, and with a higher temperature as required. The SpeedPerfect setting is suitable as a short programme for lightly soiled laundry. 	<p>Max. 9 kg/5* kg</p> <p>☼ - 90 °C</p> <p>▽, 0 - 1600^{**} rpm</p> <p>EcoPerfect, SpeedPerfect, Prewash (▽), Aqua Plus (⊗)</p> <p>Detergent ✓, fabric softener ✓</p>
<p>Cottons Eco ◁ □</p> <p>Hard-wearing fabrics, heat-resistant fabrics made of cotton or linen; energy-optimised washing that works by reducing the temperature while achieving a comparable washing result to the Cottons programme.</p> <p>Note: . The actual washing temperature may differ from the stated programme temperature for energy-saving reasons; the washing performance corresponds to the selected temperature.</p>	<p>Max. 9 kg</p> <p>☼ - 90 °C</p> <p>0 - 1600^{**} rpm</p> <p>Prewash (▽), Aqua Plus (⊗)</p> <p>Detergent ✓, fabric softener ✓</p>
<p>* Reduced load for the SpeedPerfect setting</p> <p>** Max. spin speed depends on the model</p> <p>*** Programme depends on the model</p>	

Programme/Type of laundry/Instructions	Settings
<p>Easy-Care Synthetic or blended fabrics</p>	<p>Max. 4 kg ... 60 °C 0 - 1200 rpm EcoPerfect, SpeedPerfect, Prewash (), Aqua Plus () Detergent ✓, fabric softener ✓</p>
<p>Mixed Load Mixed load of cottons and synthetic fabrics</p>	<p>Max. 4 kg - 40 °C 0 - 1600** rpm EcoPerfect, SpeedPerfect, Prewash (), Aqua Plus () Detergent ✓, fabric softener ✓</p>
<p>Delicates / Silk For delicate washable items, e.g. made of silk, satin, synthetic or blended fabrics (e.g. silk blouses, silk scarves) Note: . Use a detergent that is suitable for machine-washable delicate fabrics or silk.</p>	<p>Max. 2 kg - 40 °C 0 - 800 rpm EcoPerfect, SpeedPerfect, Prewash (), Aqua Plus () Detergent ✓, fabric softener ✓</p>
<p> Wool Hand- or machine-washable items that are made of wool or contain wool; particularly gentle wash programme to prevent laundry from shrinking, with longer pauses in the programme (during which the items rest in the water)</p> <p>Notes</p> <ul style="list-style-type: none"> ■ Wool is of animal origin, e.g. angora, alpaca, llama, sheep. ■ Use a detergent that is suitable for machine washing wool. 	<p>Max. 2 kg - 40 °C 0 - 800 rpm - Detergent -, fabric softener ✓</p>
<p>* Reduced load for the SpeedPerfect setting ** Max. spin speed depends on the model *** Programme depends on the model</p>	

Programme/Type of laundry/Instructions	Settings
<p>Rinse / Spin / Drain</p> <p>Combined extra programme for rinsing and spinning the laundry, and draining the rinsing water</p> <p>Note: . The Aqua Plus (☰) button is activated at the factory for this programme.</p> <p>If you only want to spin the laundry: Deactivate the Aqua Plus (☰) button and, if required, adjust the spin speed.</p> <p>If you only want to drain the water: Deactivate the Aqua Plus (☰) button and select the spin speed 0.</p>	<p>-</p> <p>-</p> <p>☰, 0 - 1600** rpm</p> <p>Aqua Plus (☰)</p> <p>Detergent -, fabric softener ✓</p>
<p>*** Drum Clean</p> <p>Programme for cleaning and caring for the drum and the outer tub, e.g. before running the first wash cycle, if you frequently wash laundry at a low temperature (40 °C or lower) or if an odour has developed after a prolonged period of non-use. The Drum Clean indicator light flashes if you have not used a programme at 60 °C or higher for a long time.</p> <p>Notes</p> <ul style="list-style-type: none"> ■ Run the programme without laundry. ■ Use standard washing powder or a detergent that contains bleach. To prevent foaming, only use half the amount of detergent recommended by the detergent manufacturer. Do not use detergents designed for woollens or delicates. 	<p>0 kg</p> <p>80, 90 °C</p> <p>1200 rpm</p> <p>-</p> <p>Detergent -, fabric softener -</p>
<p>SuperQuick 15'</p> <p>Extra-short programme lasting approx. 15 minutes, suitable for small items of lightly soiled laundry</p>	<p>Max. 2 kg</p> <p>☼ - 40 °C</p> <p>☰, 0 - 1200 rpm</p> <p>-</p> <p>Detergent ✓, fabric softener ✓</p>
<p>*** Dark Wash</p> <p>Dark-coloured items made from cotton or easy-care fabric; turn items inside-out before washing.</p>	<p>Max. 3.5 kg</p> <p>☼ - 40 °C</p> <p>☰, 0 - 1200 rpm</p> <p>EcoPerfect, SpeedPerfect, Prewash (⬇), Aqua Plus (☰)</p> <p>Detergent ✓, fabric softener ✓</p>
<p>* Reduced load for the SpeedPerfect setting</p> <p>** Max. spin speed depends on the model</p> <p>*** Programme depends on the model</p>	

Programme/Type of laundry/Instructions	Settings
<p>*** Allergy+</p> <p>Hard-wearing fabrics made of cotton or linen</p> <p>Note: . Particularly suitable for strict hygiene requirements or particularly sensitive skin thanks to the extended wash cycle at a defined temperature, higher water level and extended rinse cycle.</p>	<p>Max. 6,5 kg</p> <p>❄ - 60 °C</p> <p>☪, 0 - 1600** rpm</p> <p>EcoPerfect, SpeedPerfect, Prewash (☒), Aqua Plus (☕)</p> <p>Detergent ✓, fabric softener ✓</p>
<p>*** Outdoor / Impregnation</p> <p>Wash cycle followed by waterproofing of membrane-coated weatherproof and outdoor clothing or water-resistant items</p> <ol style="list-style-type: none"> 1. Select a programme. 2. Add special detergent for outdoor clothing to compartment ☒☓. 3. Press the ☒☓ button. The programme stops before the last rinse cycle. 4. Add a waterproofing agent (max. 170 ml) to compartment ☒☓. 5. Press the ☒☓ button. After-treat the laundry in accordance with the manufacturer's instructions. <p>Notes</p> <ul style="list-style-type: none"> ■ Use a special detergent that is suitable for machine washing and dose in accordance with the manufacturer's instructions: ■ Laundry must not be treated with fabric softener. ■ Before washing, clean the detergent drawer thoroughly (all compartments) to remove fabric softener residue. 	<p>Max. 1 kg</p> <p>❄ - 40 °C</p> <p>☪, 0 - 800 rpm</p> <p>EcoPerfect, SpeedPerfect, Aqua Plus (☕)</p> <p>Detergent -, fabric softener -</p>
<p>*** Outdoor</p> <p>Membrane-coated weatherproof or outdoor clothing and water-resistant fabrics</p> <p>Notes</p> <ul style="list-style-type: none"> ■ Use special detergent suitable for machine washing; add the correct dosage to compartment ☒☓ in accordance with the manufacturer's instructions. ■ Laundry must not be treated with fabric softener. ■ Before washing, clean the detergent drawer thoroughly (all compartments) to remove fabric softener residue. 	<p>Max. 2 kg</p> <p>❄ - 40 °C</p> <p>☪, 0 - 800 rpm</p> <p>EcoPerfect, SpeedPerfect, Aqua Plus (☕)</p> <p>Detergent -, fabric softener -</p>
<p>* Reduced load for the SpeedPerfect setting</p> <p>** Max. spin speed depends on the model</p> <p>*** Programme depends on the model</p>	

Programme/Type of laundry/Instructions	Settings
<p>*** Sportswear</p> <p>Sportswear and leisurewear made from microfibre fabrics</p> <p>Notes</p> <ul style="list-style-type: none"> ■ Laundry must not be treated with fabric softener. ■ Before washing, clean the detergent drawer thoroughly (all compartments) to remove fabric-softener residue. 	<p>Max. 2 kg</p> <p>☼ - 40 °C</p> <p>☒, 0 - 800 rpm</p> <p>EcoPerfect, SpeedPerfect, Prewash (☒), Aqua Plus (☒)</p> <p>Detergent -, fabric softener -</p>
<p>*** Night Wash</p> <p>Especially quiet programme for washing during the night; suitable for cotton, linen, synthetic and blended fabrics</p> <p>Notes</p> <ul style="list-style-type: none"> ■ End signal deactivated, ■ Reduced final spin speed set by default and shorter washing time 	<p>Max. 4 kg</p> <p>☼ - 40 °C</p> <p>☒, 0 - 1200 rpm</p> <p>EcoPerfect, SpeedPerfect, Prewash (☒), Aqua Plus (☒)</p> <p>Detergent ✓, fabric softener ✓</p>
<p>*** Duvet</p> <p>Machine-washable items stuffed with synthetic fibres, such as pillows, quilts and bedspreads; also suitable for items stuffed with down</p> <p>Note: . Wash large items separately. Use a detergent that is designed for delicates and follow the instructions on the item's care label. Use detergent sparingly.</p>	<p>Max. 2.5 kg (down: Max. 2 kg)</p> <p>☼ - 60 °C</p> <p>☒, 0 - 1200 rpm</p> <p>EcoPerfect, SpeedPerfect, Aqua Plus (☒)</p> <p>Detergent -, fabric softener -</p>
<p>*** Automatic 40°C</p> <p>Hard-wearing items; the degree of soiling and the type of fabric are automatically detected, and the washing sequence and intelligent dosing are adjusted accordingly.</p>	<p>Max. 6 kg</p> <p>40 °C</p> <p>☒, 1400 rpm</p> <p>-</p> <p>Detergent ✓, fabric softener ✓</p>
<p>*** Automatic Soft</p> <p>Gentler treatment of the laundry; the degree of soiling and the type of fabric are automatically detected, and the washing sequence and intelligent dosing are adjusted accordingly.</p>	<p>Max. 3.5 kg</p> <p>30 °C</p> <p>☒, 1000 rpm</p> <p>-</p> <p>Detergent ✓, fabric softener ✓</p>
<p>* Reduced load for the SpeedPerfect setting</p> <p>** Max. spin speed depends on the model</p> <p>*** Programme depends on the model</p>	

Programme/Type of laundry/Instructions	Settings
<p>*** Auto. Intensive</p> <p>More intensive treatment of the laundry; the degree of soiling and the type of fabric are automatically detected, and the washing sequence and intelligent dosing are adjusted accordingly.</p>	<p>Max. 6 kg</p> <p>60 °C</p> <p>☒, 1400 rpm</p> <p>-</p> <p>Detergent ✓, fabric softener ✓</p>
<p>Shirts</p> <p>Non-iron shirts or blouses made of cotton, linen, synthetic fibres or blended fabrics</p> <p>Note: Use the Delicates / Silk programme to wash shirts/blouses made of silk or delicate fabrics.</p>	<p>Max. 2 kg</p> <p>❄ - 60 °C</p> <p>☒, 0 - 800 rpm</p> <p>EcoPerfect, SpeedPerfect,</p> <p>Prewash (☒),</p> <p>Aqua Plus (☒)</p> <p>Detergent ✓, fabric softener ✓</p>
<p>* Reduced load for the SpeedPerfect setting</p> <p>** Max. spin speed depends on the model</p> <p>*** Programme depends on the model</p>	

Starching

Note: Laundry should not be treated with fabric softener.





1. Switch on the appliance.
2. Select the **Rinse** programme.
3. Pour liquid starch into compartment   in accordance with the manufacturer's instructions (clean first if necessary).
4. Press the  button.

Dyeing/bleaching

Dye should only be used in normal household quantities. Salt may damage stainless steel. Always follow the dye manufacturer's instructions.

Do **not** use the washing machine to bleach clothes.

Soaking

1. Switch on the appliance.
2. Select the **Cottons 30 °C** programme.
3. Use i-DOS to dose your detergent or add it to compartment   in accordance with the manufacturer's instructions.
4. Press the  button. The programme starts.
5. After approx. 10 minutes, press the  button to pause the programme.
6. Leave the laundry to soak for as long as required, then either press the  button again to continue the programme or change the programme.

Notes

- Load laundry of the same colour.
- No additional detergent is required; the soaking solution is used for washing.

P+ Programme default settings

The default programme settings are displayed in the display panel after selecting the programme.

You can change the default settings.

An overview of all programme settings, which can be selected depending on the programme, can be found from → *Page 31*.

Temperature

Depending on what stage the programme is in, you can change the set temperature before and during the programme.

The maximum temperature that can be set depends on the programme that has been selected.

Spin speed

(Spin)

Depending on what stage the programme is in, you can change the spin speed (in rpm; revolutions per minute) before and during the programme.

Setting 0: The rinsing water is drained but there is no final spin. The laundry stays wet inside the drum, e.g. for items that should not be spun.

Setting : Rinse Stop = no final spin. The laundry stays in the water after the final rinse.

You can select “Rinse Stop” to prevent creasing if the laundry will not be taken out of the washing machine immediately after the programme has ended.

To continue/end the programme
→ *Page 42*

The maximum speed that can be set depends on the model and programme that has been selected.

Finished In

Before starting the programme, you can preselect the programme end ("Ready in" time) in hourly increments (h = hour) up to a maximum of 24 hours.

To do this:

1. Select a programme.
The programme duration is displayed for the selected programme, e.g. **2:30** (hours:minutes).
2. Press the **Finished In** button repeatedly until the required number of hours is displayed.
Note: The setting values are increased using the **Finished In +** button, and decreased using the **Finished In -** button.
3. Press the  button.
The programme starts.
The selected number of hours (e.g. **8 h**) is shown in the display panel and counts down until the wash programme starts. The duration of the programme is then displayed.

Note: The length of the programme is automatically adjusted when the programme is running. Changes to the default programme settings or programme settings may also change the programme duration.

After starting the programme

(if a Finished In time has been selected and the wash programme has not yet started), you can change the preselected number of hours as follows:

1. Press the  button.
2. Use the **Finished In -** or **+** button to change the number of hours.
3. Press the  button.





After starting the programme, you can add or remove laundry if necessary.
→ *Page 42*

i-DOS settings

Your washing machine has an intelligent dosing system for liquid detergent and fabric softener.





The washing machine doses your detergent and fabric softener automatically in most programmes.
→ *Page 31*

The following have been preset at the factory:

- i-DOS  : 
Detergent dosage for lightly soiled laundry
- i-DOS  : 
Fabric softener dosage for a medium level of softness

i-DOS for detergent





Dosage strengths

-  High: heavy soiling and staining
-  Medium: average soiling
-  Low: light soiling
-  Automatic dosage deselected, manual dosage → *Page 46*

You can change the settings for automatic detergent dosage before the programme starts. You can find information on degrees of soiling on
→ *Page 30*

i-DOS for fabric softener

Dosage strengths

-  High: high level of softness
-  Medium: medium level of softness
-  Low: low level of softness
-  Automatic dosage deselected

Depending on what stage the programme is in, you can change the settings for automatic detergent dosage.

Additional programme settings

An overview of all additional settings, which can be selected depending on the programme, can be found from
→ *Page 31*.

SpeedPerfect

Washing in a shorter time while achieving a washing result that is consistent with, but uses more energy than, the selected programme, without the SpeedPerfect setting.

Note: Do not exceed the maximum load.
Overview of programmes → *Page 31*

EcoPerfect



Energy-optimised washing by reducing the temperature while achieving a washing result that is consistent with the selected programme, without the EcoPerfect setting.

Prewash



For heavily soiled laundry.

Notes

- If **intelligent dosage is selected**, the detergent will be dispensed automatically for the prewash and the main wash.
- Set the i-DOS dosage to **medium** to prevent overdosing.
- If **dosing manually**, allocate detergent to the prewash and the main wash. Place detergent for the prewash in the drum and add detergent for the main wash to compartment  .

Aqua Plus



Additional rinse cycle for particularly sensitive skin and/or for areas with very soft water.



Operating the appliance

Preparing the washing machine

Note: The washing machine **must be correctly installed and connected**.
From → [Page 14](#).

1. Connect the mains plug.
2. Turn on the tap.
3. Open the door.
4. Check that the drum is completely drained. Drain if necessary.

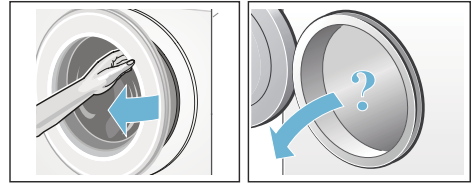

Switching on the appliance/ selecting a programme

Press the  button. The appliance is switched on.

The **Cottons** programme set at the factory is then always displayed.

You can use this programme or select a different programme. The programme selector can be turned in either direction.

Note: If you have activated the childproof lock, you must deactivate it before you can set a programme.
→ [Page 41](#)

The indicator light on the programme selector lights up and the **default programme settings** for the selected programme appear in the display panel.

- Temperature
- Spin speed
- The maximum load and the duration of the programme (alternately)
- The indicator light for the i-DOS settings, if intelligent dosage has been selected
- Information on water and energy consumption

In appliances with a **drum light**:

The drum is lit after switching on the appliance, after opening and closing the door and after starting the programme. The light switches off automatically.

Placing laundry into the drum

Warning **Danger of death!**

Items of laundry pretreated with cleaning agents that contain solvents, e.g. stain remover/cleaning solvent, may cause an explosion after being loaded into the washing machine. Hand-rinse these items of laundry thoroughly beforehand.

Notes

- Mix items of laundry of varying sizes. Laundry items of different sizes distribute themselves better during the spin cycle. Individual laundry items may cause an unbalanced load.
 - Observe the maximum specified load. Overfilling adversely affects the washing result and promotes creasing.
1. Unfold presorted laundry items and place them in the drum.
 2. Make sure that no items of laundry are trapped between the door and the rubber seal, and close the door.





The  button indicator lamp flashes and the programme settings appear in the display panel.



Measure and add detergent and care products

The washing machine doses your detergent and fabric softener automatically in most programmes.

The intelligent dosage has been preset at the factory for all programmes in which it can be used.

You can use these default settings or change them. → Page 38

In addition to intelligent dosage, cleaning aids (e.g. stain remover) can be added manually to compartment  , if necessary. → Page 46

For programmes that cannot be used with intelligent dosage, or if you would prefer to dose manually (in which case set intelligent dosage to "off" ) , add detergent to compartment  . → Page 46

Change the programme default settings

You can use the default settings for each washing cycle or change them.

To do this, repeatedly press the corresponding button until the required setting is displayed.

Note: . Pressing and holding the buttons automatically runs through the setting values until the last one. Then press the button again and you will be able to change the setting values again.

The settings are activated without needing to be confirmed.

Notes

- The i-DOS settings are saved until they are changed again, even if the washing machine is switched off.
- Other programme settings are not saved if the washing machine is switched off.

Default programme settings
→ Page 37

Select additional programme settings

By selecting additional settings, you can better adapt the washing process to your items of laundry.

The settings can be selected or deselected depending on the programme progress.

The button indicator lamps light up if a setting is activated.

The settings are not saved after switching off the washing machine.

Additional programme settings
→ *Page 38*

Start the programme

Press the  button. The indicator lamp lights up and the programme starts.

Note: You will need to press and hold the  button to start the programme. This prevents the programme from being started if something accidentally brushes against the button.

The display panel shows the "Ready in" time while the programme is running or the programme length and the programme progress symbols when the washing programme has started.
Display panel → *Page 27*

Note: Foam detection

If the  symbol also lights up in the display panel, the washing machine has detected too much foam during the wash programme and automatically activated additional rinse cycles to remove the foam.

Add less detergent to the next washing cycle with the same load.



If you want to lock the programme to prevent it from being inadvertently adjusted, you can select the childproof lock as follows.

Child Lock 3 sec.

()

You can lock the washing machine to prevent the functions you have set from being changed inadvertently. To do this, activate the childproof lock.

To **activate/deactivate**, press and hold the **Finished In -** and **+** buttons at the same time for approx. three seconds. The  symbol is appears in the display panel.

-  lights up: The childproof lock is active.
-  flashes briefly: The childproof lock is active and the programme selector was turned or a button was pressed.

Note: The childproof lock remains active, even once the washing machine has been switched off. Before selecting the next programme, deactivate the childproof lock.

Adding laundry

After starting the programme, you can add or remove laundry if necessary.

Press the ▷ button to do this.

The ▷ button indicator lamp flashes and the machine checks whether it is possible to add laundry.

If the following appears in the display panel:

- **Both** the - P - and 🌀 symbols light up, it is possible to add laundry.
- - P - lights up, it is not possible to add laundry.

To continue the programme, press the ▷ button. The programme continues automatically.

Notes

- Do not leave the door open for too long when adding laundry as water from the laundry may leak out.
- For safety reasons, the door remains locked when the water level or temperature is high, or while the drum is turning, and it is not possible to add laundry during this time.
- The load display is not active during reloading.

Changing the programme

If you have started the wrong programme by mistake, you can change the programme as follows:

1. Press the ▷ button.
2. Select another programme.
3. Press the ▷ button. The new programme starts from the beginning.

Cancel the programme

For programmes at high temperatures:

1. Press the ▷ button.
2. To cool down laundry: Select **Rinse**.
3. Press the ▷ button.

For programmes at low temperatures:

1. Press the ▷ button.
2. Select **Spin** or **Drain**.
3. Press the ▷ button.

Programme end during rinse hold

In the display panel, ☹ flashes, and the preset spin speed and remaining programme length are displayed for the selected programme.

Continue the programme by:

- Pressing the ▷ button or
- Changing the spin speed, or setting the programme selector to **Drain** and then pressing the ▷ button.

Programme end

- 0 - and 🌀 appear in the display panel. The ▷ button indicator lamp is off.

Removing laundry/switching off the appliance

1. Open the door and remove the laundry.
2. Press the Ⓛ button. The appliance is switched off.
3. Turn off the tap.
Note: Not required for Aqua-Stop models.

Notes

- Do not leave any items of laundry in the drum. They may shrink in the next wash or discolour another item.
- Remove any foreign objects from the drum and the rubber seal – risk of rusting.
- Wipe the rubber seal dry.

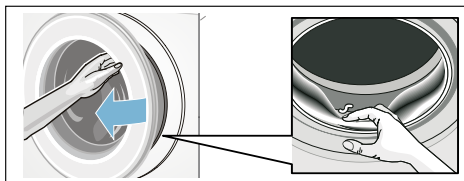



- Leave the door and detergent drawer open so that any residual water can evaporate. → Page 55
- Always wait until the programme ends, as the appliance could still be locked. Then switch the appliance on and wait for it to unlock.
- If the display panel goes off at the end of a programme, the energy-saving mode is active. Press any button to activate the panel.

i-DOS Intelligent dosing system



Intelligent dosing system in the detergent drawer

i-DOS Intelligent **D**osing system

Your washing machine has an intelligent dosing system for liquid detergent and fabric softener.

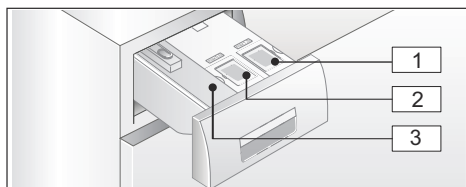
The i-DOS compartments  and  in the detergent drawer are used for this purpose.



- 1** Dispenser  (1.3 l) for liquid detergent
- 2** Dispenser  (0.5 l) for fabric softener
- 3** Compartment  for manual dosing → Page 46

Depending on the selected programme and settings, the optimum quantity of detergent and/or fabric softener is dosed by the i-DOS dispensers.

Initial use/filling the dispensers

Refer to the manufacturer's instructions when choosing your detergent and fabric softener. We recommend the use of standard, universal and colour liquid detergents for all machine-washable, coloured fabrics made of cotton or synthetic materials.

Notes

- Only use easy-pour liquid products that the manufacturer recommends adding to the detergent drawer.
- Do not mix different liquid detergents. If changing your liquid detergent (type, manufacturer, etc.), empty the dispenser completely and clean it. → Page 56
- Do not use products containing solvents, caustic agents or volatile substances (e.g. bleach).
- Do not mix detergent and fabric softener.
- Do not use products that have expired or are highly congealed.
- To prevent drying out, do not leave the dispenser lids open for a long period of time.

Filling the dispensers:

The lids of the dispensers in the detergent drawer are marked with the following symbols:

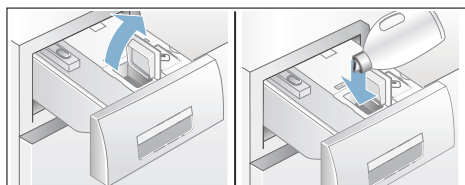

-  Standard/universal detergent
-  Fabric softener

1. Open the detergent drawer.
2. Open the dispenser lid(s).
3. Add detergent and/or fabric softener. Do not fill above the **max.** marking.



4. Close the lid(s).
5. Slowly push the detergent drawer in completely.

When the appliance is switched on, the fact that the detergent drawer is closed completely is indicated by the following:

- If intelligent dosage i-DOS  or i-DOS  has been selected, the corresponding indicator lights up.
- If intelligent dosage has not been selected, the indicator flashes once and then goes out.
- The  symbol in the display panel goes out.

Everyday use

Indicator lights in the display panel:

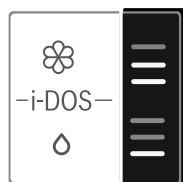





- The display **lights up** if intelligent dosage has been selected for the dispenser.
- The display **flashes** if the fill level of the selected intelligent dosing dispenser is below the minimum level.



(De)selecting intelligent dosage and adjusting the dosage strength:

The intelligent dosages for detergent and fabric softener are set at the factory for programmes in which intelligent dosage can be used.

Overview of programmes → *Page 31*

The dosage strength has been preset to low (lightly soiled laundry) for detergent  and to medium (medium level of softness) for fabric softener . It can be changed for each programme. → *Page 38*

In addition to intelligent dosage, cleaning aids (e.g. stain remover) can be added manually to compartment  , if necessary. → *Page 46*

Note: The selection (on/off) and the selected dosage strength for i-DOS  and i-DOS  are saved for each programme until they are changed again, even if the washing machine is switched off.

Topping up the detergent/ fabric softener:

If the indicator light for the selected intelligent dosage flashes, this means that the amount of detergent or fabric softener in the dispenser is below the minimum fill level. The contents will last for another three washes or so.

The same detergent or fabric softener can be added at any time. If you change product/manufacturer, we recommend that you clean the dispensers first. → *Page 56*

If required, adjust the basic dosage.

Basic settings

The basic dosages are:

- **For detergents** – based on the manufacturer's recommendation for average soiling and the respective water hardness.
- **F or fabric softeners** – based on the manufacturer's recommendation for a medium level of softness.

Refer to the packaging label on your detergent/fabric softener or ask the manufacturer directly for this information.

To find out the hardness of your water supply, use a test strip or check with your water supplier.

My water hardness:



Below is an example of detergent dosages on a packaging label:

Degree of soiling → Water hardness ↓	light	normal	heavy	very heavy
soft/medium	55 ml	75 ml	120 ml	160 ml
hard/very hard	75 ml	95 ml	150 ml	180 ml

The default setting for the basic dosage is set specifically according to the area in which you live (e.g. 75 ml for detergent and 36 ml for fabric softener).

Set the basic detergent dosage according to the detergent's packaging label. Take your water hardness into consideration when doing so.

Select the basic fabric softener dosage according to how soft you would like your laundry to be.

Changing one basic dosage affects all three dosage quantities in the same way.

Notes



- Reduce the basic dosage if using a very concentrated detergent.
- If large amounts of foam are repeatedly created during washing, please check your basic dosage and dosage quantity settings. Certain types of liquid detergent can also create excessive amounts of foam. If your basic dosage and dosage quantity settings are correct, we advise you to use a different detergent.

Changing the basic dosages:

1. Press the corresponding i-DOS button (O or ⌘) for approx. 3 seconds. The preset basic dosage will appear in the display panel.
2. Set the required basic dosage using the **Finished In -** or **+** buttons.
3. The setting is activated without needing to be confirmed. You can now wait for a short while or press any button (except the i-DOS buttons) to revert to the original setting.

Note: The settings are saved until they are changed again, even if the machine is switched off.

Manual dosage

For programmes that cannot be used with intelligent dosage, or if you would prefer to dose manually (in which case set intelligent dosage to "off" ) , add detergent to compartment  .

Cleaning aids such as water softener, bleach and stain remover can be added to this compartment in addition to the intelligent dosage.

Warning **Eye/skin irritation!**

Detergent and care products may spray out if the detergent drawer is opened while the machine is in operation.

Open the drawer carefully.

Rinse eyes or skin thoroughly if they come into contact with detergent/care products.

If swallowed accidentally, seek medical advice.

Caution!

Damage to the appliance

Cleaning agents and agents for pretreating laundry (e.g. stain removers, prewash sprays, etc.) may cause damage if they come into contact with the surfaces of the washing machine. Do not allow these agents to come into contact with the surfaces of the washing machine. If necessary, immediately wipe away spray residue and other residues/droplets with a damp cloth.



Notes

- When dosing all detergents, cleaning aids and cleaning agents, always follow the manufacturer's instructions.
- If dosing detergent manually, do not add additional detergent to the intelligent dosage dispenser (set intelligent dosage to "off" ). This will prevent overdosing and foaming.
- Dilute viscous fabric softener and fabric conditioner with water to prevent blockages.

Dosing and adding detergent:

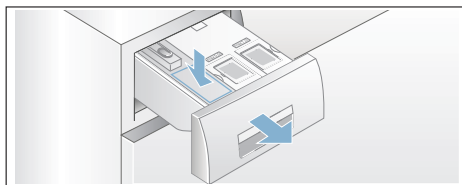
1. Pull out the detergent drawer.



2. Add the correct dosage to compartment   depending on:
 - Soiling
 - Water hardness (ask your water supply company)
 - The amount of laundry
 - The manufacturer's instructions
3. Close the detergent drawer.



Home Connect

This appliance is Wi-Fi enabled and can be controlled remotely via a smartphone or tablet PC.

With the Home Connect app, you can use your smartphone or tablet PC to do the following on this appliance:

- Select and start programmes.
- Change programme settings.
- Query the status of programmes.
- Change appliance settings.
- Switch off the appliance.

Before you can use the Home Connect functions, you will need to install the Home Connect app on your smartphone or tablet PC, register, connect your appliance automatically **or** manually to your home Wi-Fi network (you only need to do this the first time) and then connect your mobile device to your appliance via the Home Connect app.

You can find information about the app on our Home Connect website www.home-connect.com.

The availability of the Home Connect functionality depends on the availability of the Home Connect Services in your country. Home Connect Services are not available in every country – for further information please check: www.home-connect.com

Notes

- Please observe the safety precautions in this instruction manual and make sure that these are complied with even when operating the appliance via the Home Connect app while you are away from home. You must also follow the instructions in the Home Connect app.

- You cannot use the Home Connect app to make changes while the appliance is in operation. You will be able to use the Home Connect app to see any adjustments made directly on the appliance itself, however.

Connecting to your home network automatically

If your router has a WPS function, you can connect the appliance to your home network automatically.

If your router does not have a WPS function, you will need to connect the appliance to your home network manually .

Wi-Fi must be switched on on the appliance.

1. Switch the appliance on.
2. Press and hold the **Remote Start**  button for more than 3 seconds. *Aut* (connect automatically) will appear on the display panel.

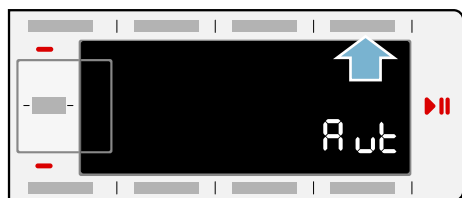

3. Press the Start button to connect.  will flash on the display panel. The appliance will now try to connect to your home network.
4. Activate the WPS function on your home network router within the next 2 minutes.

If the appliance has connected to your home network successfully, *con* (connected) will appear on the display panel and  will be lit continuously.

5. You can exit the Home Connect settings by pressing the **Remote Start**  button.

Note: If a connection could not be established, *Err* (fault) will appear on the display panel. Check whether your appliance is in range of your home network. Try connecting automatically again or connect your appliance manually → Page 49.

Connecting to your home network manually

If you have already automatically connected your appliance to your home network, you can skip the manual connection step and connect it to the Home Connect app .

If your router does not have a WPS function, you will need to connect the appliance to your home network manually.

Wi-Fi must be switched on on the appliance.

1. Switch the appliance on.
2. Press and hold the **Remote Start**  button for more than 3 seconds. **Aut** (connect automatically) will appear on the display panel.

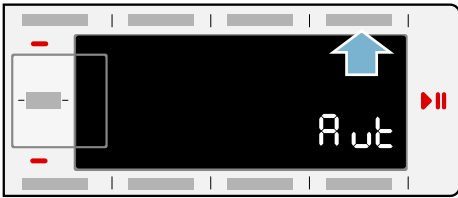

3. Turn the programme selector to position 2. **SAP** (connect manually) will appear on the display panel.

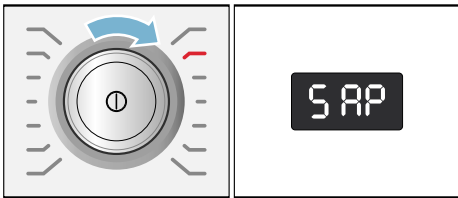



4. Press the Start button to connect.  will flash on the display panel. The appliance will now set up its own Wi-Fi network with the name (SSID) **Home Connect**, which you can access from your smartphone or tablet PC.
5. Call up the Wi-Fi settings on your smartphone or tablet PC.

6. Connect your smartphone or tablet PC to the **HomeConnect** Wi-Fi network and enter the password (key) "**HomeConnect**".

Note: The connection process may take up to 60 seconds.

7. Once you have connected successfully, open the Home Connect app on your smartphone or tablet PC.
8. In the Home Connect app, enter the name (SSID) and password (key) for **your home network** and then select **Transfer to appliance**.

If the appliance has connected to your home network successfully, **CON** (connected) will appear on the display panel and  will be lit continuously.

9. You can exit the Home Connect settings by pressing the **Remote Start**  button.

Notes

- If a connection could not be established, **Err** (fault) will appear on the display panel. Check whether your appliance is in range of your home network and try connecting manually again.
- If your smartphone or tablet PC is still connected to the **Home Connect** network, you will need to connect it to your home network first.

Connecting to the Home Connect app

If your appliance is connected to your home network, you can connect it to the Home Connect app.

1. Switch the appliance on.
2. Press and hold the **Remote Start**  button for more than 3 seconds. **Aut** (connect automatically) will appear on the display panel.

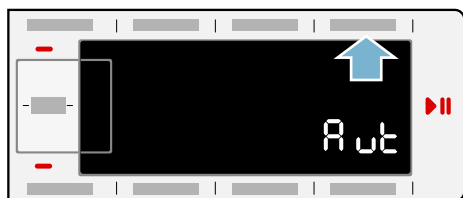

3. Turn the programme selector to position 3. **APP** (connect to app) will appear on the display panel.

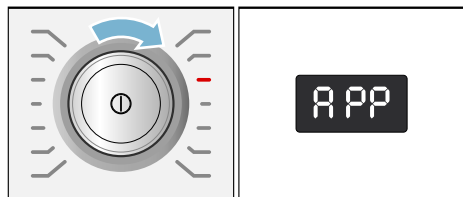

4. Press the Start button.
The appliance will now connect to your Home Connect app.
5. Open the Home Connect  app on your smartphone or tablet PC and select **Connect** to add your new appliance.
Note: If your smartphone or tablet PC is still connected to the **Home Connect** network, you will need to connect it to your home network first.
6. If your appliance is not shown automatically, select **Appliance search** and then **Connect an appliance** in the Home Connect app.

7. Carry out the last steps in the Home Connect app to connect your appliance.

If the appliance has connected successfully, **con** (connected) will appear on the display panel.

8. You can exit the Home Connect settings by pressing the **Remote Start**  button.

Note: If a connection could not be established, **Err** (fault) will appear on the display panel. Check whether your smartphone or tablet PC is in range of your home network and whether it is connected to it. Try connecting to the Home Connect app again.

Activating or deactivating Wi-Fi

You can switch the Home Connect function on your appliance on or off permanently at any time.

1. Switch the appliance on.
2. Press and hold the **Remote Start**  button for more than 3 seconds. **Aut** (connect automatically) will appear on the display panel.

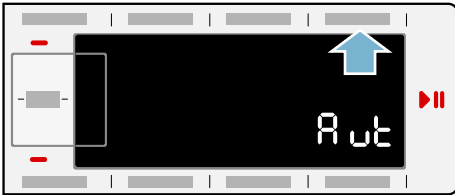

3. Turn the programme selector to position 4. **Con** (Wi-Fi function) will appear on the display panel.

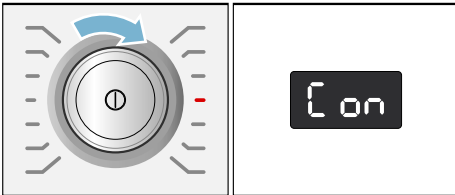

4. Press the Start button. **on** will appear on the display panel (switched on). The appliance's Wi-Fi function is now switched on. **off** will appear on the display panel (switched off). The appliance's Wi-Fi function is now switched off.
5. You can exit the Home Connect settings by pressing the **Remote Start**  button.

Note: If **on** (switched on) appears on the display but you actually wanted to select **off** (switched off), you will need to repeat all of these steps again.

Note: If Wi-Fi is not activated on your appliance, you will not be able to connect it to your home network or to the app.

Resetting your network settings

You can clear the network settings and break the connection to your smartphone or tablet PC by resetting the network settings.

1. Switch the appliance on.
2. Press and hold the **Remote Start**  button for more than 3 seconds. *Aut* (connect automatically) will appear on the display panel.

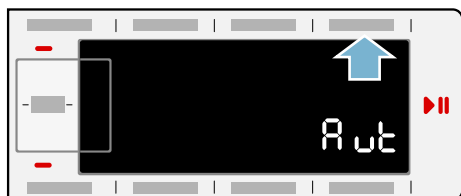

3. Turn the programme selector to position 5. *rES* (reset network settings) will appear on the display panel.

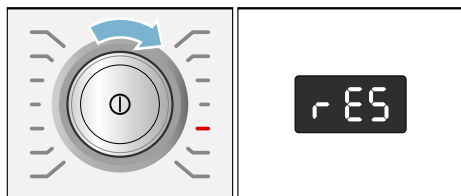

4. Press the Start button.
5. *YES* (yes) will appear on the display panel.
6. Press the Start button to confirm. *End* (end) will appear on the display panel. The network settings have now been reset. Your appliance is no longer connected to your home network or the Home Connect app.
7. You can exit the Home Connect settings by pressing the **Remote Start**  button.

Notes

- If the network settings could not be reset, *Err* (fault) will appear on the display panel.
- If you want to operate the appliance via the Home Connect app again, you will need to reconnect it to your home network and to the Home Connect app either automatically or manually.

Updating the software

You can update the Home Connect software on your appliance. Whenever a new update is available, **UPd** (update) will appear on the display panel.

You can install the update directly via the message on the display panel or via the appliance settings.

1. Switch the appliance on.
2. Press and hold the **Remote start**  button for more than 3 seconds. **Aut** (connect automatically) will appear on the display panel.

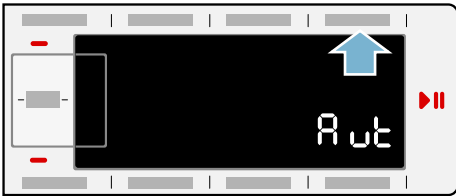

3. Turn the programme selector to position 6. **UPd** (update) will appear on the display panel.

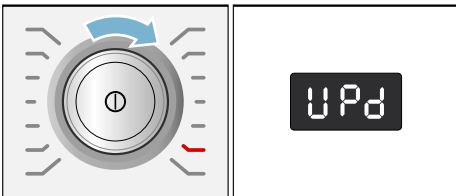

The Start button will flash if a software update is available.

4. Press the Start button. **YES** (yes) will appear on the display panel.
5. Press the Start button to confirm. Update installation will now start. This process may take several minutes. Do not switch the appliance off while updates are being installed.
6. You can exit the Home Connect settings by pressing the **Remote start**  button.

About data protection

When your appliance is connected for the first time to a WLAN network, which is connected to the Internet, your appliance transmits the following categories of data to the Home Connect server (initial registration):

- Unique appliance identification (consisting of appliance codes as well as the MAC address of the installed WiFi communication module).
- Security certificate of the WiFi communication module (to ensure a secure IT connection).
- The current software and hardware version of your domestic appliance.
- Status of any previous resetting to factory settings.

This initial registration prepares the Home Connect functions for use and is only required when you want to use these Home Connect functions for the first time.

Note: Ensure that the Home Connect functions can be used only in conjunction with the Home Connect app. Information on data protection can be accessed in the Home Connect app.

Declaration of Conformity

BSH Hausgeräte GmbH hereby declares that the appliance with Home Connect functionality meets the basic requirements and other relevant provisions of the Directive 1999/5/EC.

A detailed R&TTE Declaration of Conformity can be found online at www.bosch-home.com among the additional documents on the product page for your appliance.



Appliance settings

You can change the following settings:

- The volume of the buttons and the information signals (e.g. at the end of the programme)
- Select/deselect the appliance's automatic switch-off function → *Page 13*
- Switch the drum-care information signal on/off (depending on the model).

You will need to activate the setting mode in order to change these settings.

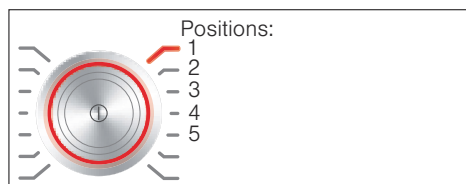

Activating the setting mode

1. Press the **⏸** button.
The appliance is switched on and the **Cottons** programme is shown at position 1.
2. Press the **Temperature** button and, at the same time, turn the programme selector clockwise to position 2. Release the button.
The setting mode is activated and the preset volume for the information signals appears in the display panel.

You can now change the settings:

Changing the signal volume

Use the **Finished In +** or **-** button to change the following settings at the corresponding programme selector positions:

- 2: The volume of the information signals and/or
- 3: The volume of the button signals.



- 0 = off,
- 1 = quiet,
- 2 = medium,
- 3 = loud,
- 4 = very loud

Exit setting mode or:

Selecting/deselecting the appliance automatic switch-off

With the programme selector in position 4, press the **Finished In+** or **-** button to switch the "Automatic switch-off" function on or off.

Note: If you have Wi-Fi switched on, the "Automatic switch-off" function is switched off.

Exit setting mode or:

Switching the drum-care information signal on/off

depending on the model

With the programme selector in position 5, press the **Finished In +** or **-** button to switch the **Drum Clean** information signal on or off.

Exiting setting mode

To exit and save the settings, press the  button.

The appliance is switched off. The selected settings will take effect the next time the washing machine is switched on.

Sensors

Automatic load sensing

Depending on the type of fabric and load, the automatic load sensing function optimally adjusts the water consumption and programme duration in each programme.

Unbalanced load detection system

The automatic unbalanced load detection system detects imbalances and ensures even distribution of the laundry by repeatedly starting and stopping drum spinning.

If the laundry is extremely unevenly distributed, the speed is reduced or the spin cycle is not performed for safety reasons.

Note: Place large and small items of laundry evenly in the drum.

→ Page 40, → Page 62

AquaSensor

depending on the model

During the rinse cycle, the AquaSensor checks the degree of turbidity (turbidity is caused by dirt and detergent residue) of the rinsing water. The duration and the number of rinse cycles depend on the turbidity of the water.



Cleaning and maintenance

Warning **Danger of death!**

There is a risk of electric shock if you touch live components. Switch off the appliance and pull out the mains plug.

Warning **Risk of poisoning!**

Toxic vapours can be produced by cleaning agents that contain solvents, e.g. cleaning solvent. Do not use cleaning agents that contain solvents.

Caution! **Damage to the appliance**

Cleaning agents that contain solvents, e.g. cleaning solvent, can damage surfaces and components in the machine. Do not use cleaning agents that contain solvents.

Prevent detergent residue from building up and odours from forming by following these instructions:

Notes

- Ensure the room in which the washing machine is set up is well ventilated.
- Leave the door and detergent dispenser tray open slightly when the washing machine is not in use.
- Occasionally run a wash using the **Cottons 60 °C** programme and powder detergent.

Machine housing/control panel

- Wipe the housing and the control panel with a soft, damp cloth.
- Remove the detergent residue immediately.
- Do not clean with a water jet.

Drum

Use chlorine-free cleaning agents, do not use steel wool.

If there are odours in the washing machine, or to clean the drum, run the **Drum Clean 90 °C** programme without laundry. Add washing powder.

Descaling

Descaling should not be necessary if the detergent is measured out correctly. However, if it is required, follow the manufacturer's instructions for the descaling agent. Suitable descalers can be obtained via our website or from customer services. → Page 64

i-DOS detergent draw and its housing

1. Emptying the dispensers:

The dispensers have emptying outlets with removable sealing plugs at the front. To empty the dispensers, first remove the drawer handle as shown below:

a) Pull out the detergent drawer.

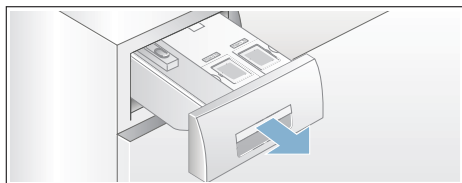

b) Pull the catch (A) on the back of the drawer handle (in the centre at the bottom) slightly towards you. This unlocks the drawer handle (B), which you can then pull off by lifting it upwards.

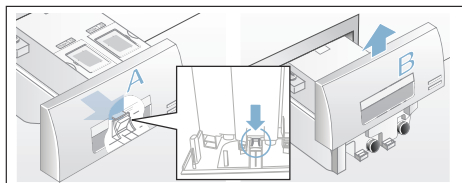

c) To empty the dispensers, carefully pull off each of the sealing plugs and empty the contents into a suitable container.

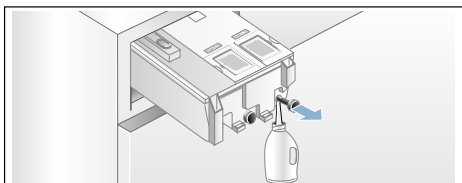

d) Then push the sealing plugs back in completely.

2. Cleaning the dispensers/detergent drawer:

The detergent drawer can be removed completely to allow you to clean the dispensers after you have emptied them.

- a) Empty the dispensers before removing the drawer.

Note: Only put the drawer handle back on after you have finished cleaning.

- b) Pull out the drawer.
- c) Press the catch and remove the drawer completely.

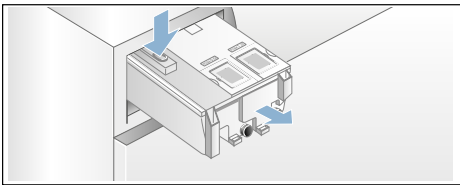

- d) Carefully remove the drawer cover.

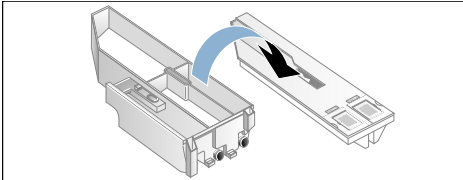

Caution!

Risk of damage to the detergent drawer.

The detergent drawer contains electrical components. These may become damaged if they come into contact with water.

- Do not clean the cover in the dishwasher and do not immerse it in water.

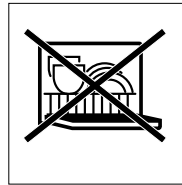

- Protect the rear drawer connector against water, detergent or fabric-softener residue; if necessary, clean the outer surfaces with a soft, damp cloth. Dry before putting back in.
- e) Clean the drawer and the cover with a soft, damp cloth or a hand shower. Also clean the inner surfaces with a soft, damp cloth.

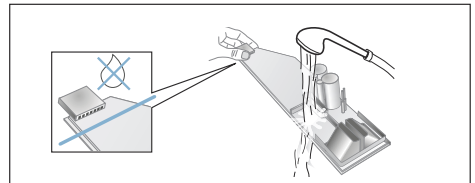

- f) Dry the drawer and the cover and put them back together.
- g) Push the drawer handle back in from above until you feel it click in place.
- h) Clean the inside of the detergent-drawer housing.
- i) Push the detergent drawer in completely.

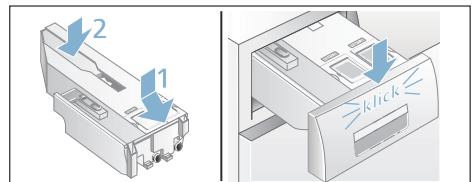

The drain pump is blocked, emergency draining

⚠ Warning
Risk of scalding!

When you wash at high temperatures, the water gets very hot. If you come into contact with the hot water, you may be scalded.

Allow the water to cool down.

1. Turn off the water tap so that no more water can flow in and has to be drained via the drain pump.
2. Switch off the appliance. Pull out the mains plug.
3. Open and remove the service flap.

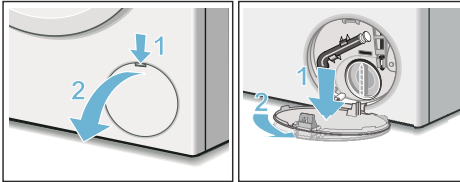

4. Take the drain hose out of the retainer.
Remove the sealing cap and pour the water out into a suitable container.
Replace the sealing cap and place the drain hose back in the retainer.

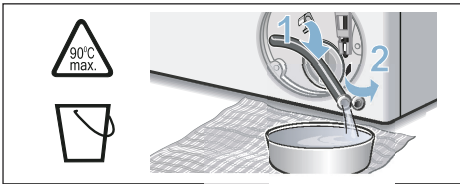

5. Carefully unscrew the pump cover; residual water may leak out.
Clean the interior, pump-cover thread and pump housing. The impeller in the drain pump must be able to rotate.
Refit the pump cover and screw it on tightly. The handle must be in a vertical position.

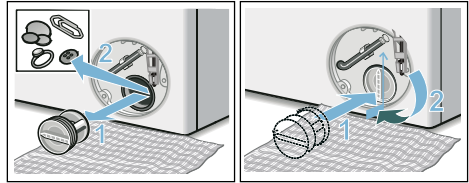

6. Put the service flap back on, lock it into place and close it.

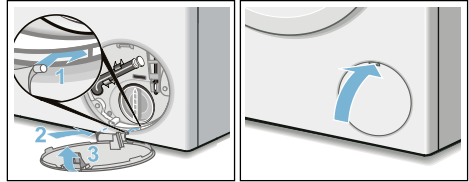

Note: To prevent unused detergent from flowing straight into the drain during the next wash, pour 1 litre of water into compartment  and start the **Drain** programme.

The drain hose at the siphon is blocked

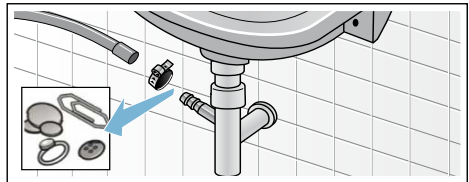

1. Switch off the appliance. Pull out the mains plug.
2. Loosen the hose clamp. Carefully remove the drain hose; residual water may leak out.
3. Clean the drain hose and siphon connecting piece.



4. Re-attach the drain hose and secure the connection point using the hose clamp.

Filter in the water supply blocked

First, reduce the water pressure in the supply hose:

1. Turn off the tap.
2. Select any programme (except Rinse/Spin/Empty).
3. Press the  button. Allow the programme to run for approximately 40 seconds.
4. Press the  button. The appliance is switched off.
5. Pull out the mains plug.

Then clean the filter:

1. Disconnect the hose from the tap.
Clean the filter with a small brush.

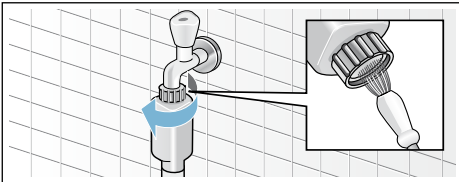

2. For standard and Aqua-Secure models, clean the filter on the rear of the appliance:
Remove the hose from the rear of the appliance.
Use pliers to remove the filter and then clean it.

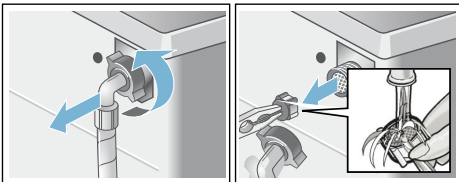

3. Connect the hose and check for leaks.

Faults and what to do about them.

Emergency release

E.g. in the event of a power cut

The programme continues when the power supply is restored.

However, if the laundry has to be removed, the washing machine door can be opened as follows:

Warning **Risk of scalding!**

When you are washing at high temperatures, there is a risk of scalding if you come into contact with hot water and laundry.

If possible, leave it to cool down first.

Warning **Risk of injury!**

You may injure your hands if you reach into the drum while it is turning.

Do not reach into the drum when it is turning.

Wait until the drum has stopped turning.

Caution! **Water damage**







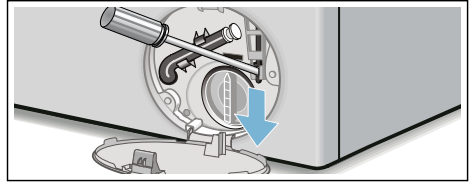

Any escaping water may cause water damage.

Do not open the door if water can be seen through the glass.







1. Switch off the appliance. Pull out the mains plug.
2. Drain the water. → *Page 58*
3. Pull the emergency release downwards with a tool and release. The door can then be opened.







Information on the display panel

Indicator	Cause/remedy
- P - and 	The door is unlocked. It is possible to add laundry.
- P -	<ul style="list-style-type: none"> ■ The temperature is too high. Wait until the temperature drops. ■ The water level is too high. It is not possible to add laundry. Close the door immediately, if necessary. Press the  button to resume the programme.
 is flashing	<ul style="list-style-type: none"> ■ Laundry may be trapped. Open and close the door again and press the  button. ■ If necessary, push the door closed or remove the trapped laundry and then push it closed again. ■ If necessary, switch the appliance off and then on again; set a programme and apply the settings you require; start the programme.
 is flashing	The detergent drawer has not been pushed in fully. Push the drawer in correctly.
 is lit continuously	<ul style="list-style-type: none"> ■ Turn the tap on fully, ■ The supply hose is kinked/trapped, ■ The water pressure is too low. Clean the filter. → <i>Page 59</i>
E:18	<ul style="list-style-type: none"> ■ The drain pump is blocked. Clean the drain pump. → <i>Page 58</i> ■ The drain hose/drain pipe is blocked. Clean the drain hose at the siphon. → <i>Page 58</i>
E:23	There is water in the base trough; the appliance is leaking. Turn off the tap. Call the after-sales service. → <i>Page 64</i>
	The childproof lock is activated – deactivate it. → <i>Page 41</i>
 is lit continuously	Too much foam has been detected and additional wash cycles have been activated. Add less detergent to the next wash cycle with the same load.
The indicator light for the Drum Clean programme* is flashing * Depending on the model	<p>Run the Drum Clean 90 °C programme or a 60 °C programme to clean and care for the drum and the outer tub.</p> <p>Notes</p> <ul style="list-style-type: none"> ■ Run the programme without laundry. ■ Use standard washing powder or a detergent that contains bleach. To prevent foaming, only use half the amount of detergent recommended by the detergent manufacturer. Do not use detergents intended for woollens or delicates. ■ Switching the information signal on/off → <i>Page 54</i>
	<p>Off: Wi-Fi is switched off and the appliance is not connected to your home network.</p> <p>Flashing: The appliance is trying to connect to your home network.</p> <p>Continuously lit: Wi-Fi is switched on and the appliance is connected to your home network.</p>
Other indicators	Switch off the appliance, wait for 5 seconds and then switch it back on. If the indicator appears again, call the after-sales service. → <i>Page 64</i>

Faults and what to do about them.

Faults	Cause/remedy
Water is leaking from the machine.	<ul style="list-style-type: none"> ■ Attach the drain hose correctly or replace it. ■ Tighten the threaded joint on the supply hose.
The appliance is not filling with water.	<ul style="list-style-type: none"> ■ Have you pressed the  button? ■ Is the tap turned on?
Detergent is not being dispensed.	<ul style="list-style-type: none"> ■ Could the filter be clogged? Clean the filter. → <i>Page 59</i> ■ Is the supply hose kinked or trapped?
The dispenser is empty and the fill level indicator is not flashing.	<ul style="list-style-type: none"> ■ Is the drawer cover/connector dirty? Clean the detergent drawer. → <i>Page 56</i> ■ Has the detergent drawer been pushed in correctly? → <i>Page 43</i>
The wrong detergent/fabric softener has been poured into the dispenser(s).	<p>Dispenser(s):</p> <ol style="list-style-type: none"> 1. Empty and clean. → <i>Page 56</i> 2. Refill. → <i>Page 44</i>
Detergent/fabric softener has congealed in the dispensers.	Clean and refill the dispensers.
The door will not open.	<ul style="list-style-type: none"> ■ The safety function is activated. Stop the programme? → <i>Page 42</i> ■ Is the  childproof lock activated? Deactivate it. → <i>Page 41</i> ■ Is  selected (Rinse Stop = no final spin)? → <i>Page 42</i> ■ Can the door only be opened by the emergency release? → <i>Page 60</i>
The programme will not start.	<ul style="list-style-type: none"> ■ Have you pressed the  button or selected Finished In time? ■ Is the door closed? ■ Is the  childproof lock activated? Deactivate it. → <i>Page 41</i> ■ If  is flashing, the detergent drawer has not been pushed in fully. Push the drawer in correctly.
The drum briefly jerks or judders after the programme has started.	Not a fault – the internal motor test may cause the drum to jerk or judder briefly when the wash programme starts.
The water is not draining.	<ul style="list-style-type: none"> ■ Is  selected (Rinse Stop = no final spin)? → <i>Page 42</i> ■ Clean the drain pump. → <i>Page 58</i> ■ Clean the drain pipe and/or the drain hose.
Water is not visible in the drum.	Not a fault – the water is below the visible area.
The spin result is not satisfactory.	<ul style="list-style-type: none"> ■ Not a fault – the unbalanced load detection system has interrupted the spin cycle because the laundry is unevenly distributed.
Laundry wet/too damp.	<ul style="list-style-type: none"> ■ Distribute small and large items of laundry evenly in the drum. ■ Is the selected speed too low?
The appliance restarts the spin cycle several times.	Not a fault – the unbalanced load detection system is adjusting an imbalance.

Faults	Cause/remedy
The programme is taking longer than usual.	<ul style="list-style-type: none"> ■ Not a fault – the unbalanced load detection system is adjusting an imbalance by repeatedly redistributing the laundry. ■ Not a fault – the foam detection system is active – a rinse cycle has been switched on.
The length of the programme changes during the wash cycle.	Not a fault – the programme sequence is optimised for the specific washing process. This may change the length of the programme shown on the display panel.
Water remaining in the care-product compartment  .	<ul style="list-style-type: none"> ■ Not a fault – the effectiveness of the care product is not affected.
Odours in the washing machine.	Run the Drum Clean or Cottons 90 °C programme without laundry. Add standard washing powder or a detergent that contains bleach. Note: To prevent foaming, only use half the amount of detergent recommended by the detergent manufacturer. Do not use detergents intended for woollens or delicates.
The  symbol is lit on the display panel. Foam may also be leaking from the detergent drawer.	Have you used too much detergent? Mix one tablespoon of fabric softener with 1/2 litre of water and pour it into compartment   (not suitable for outdoor clothing, sportswear or items made with down). Use less detergent for the next wash cycle.
Repeated, intensive foaming.	<ul style="list-style-type: none"> ■ Check your basic dosage and dosage strength settings. ■ If necessary, use a different liquid detergent.
Detergent/fabric softener drips off the seal and collects on the door or in the seal fold.	There is too much detergent/fabric softener in the dispensers. Do not fill the dispensers above the Max. mark.
I am unable to connect to my home network. The  symbol does not appear on the display panel.	<ul style="list-style-type: none"> ■ Wi-Fi is switched off. To connect to your home network, switch on Wi-Fi. → <i>Page 51</i> ■ Wi-Fi is switched on but I have not been able to connect to my home network. Check whether your home network is available or try to connect to your home network again.
Home Connect is not working.	<ul style="list-style-type: none"> ■ You can find solutions to problems with Home Connect at www.home-connect.com. ■ The availability of the Home Connect functionality depends on the availability of the Home Connect Services in your country. Home Connect Services are not available in every country - for further information please check: www.home-connect.com.
Loud noises, vibrations and machine “wandering” during the spin cycle.	<ul style="list-style-type: none"> ■ Is the appliance level? Level the appliance. → <i>Page 20</i> ■ Are the appliance's feet secured? Secure the appliance's feet. → <i>Page 20</i> ■ Have the transportation securing means been removed? Remove the transportation securing means. → <i>Page 16</i>

Faults	Cause/remedy
The display panel/indicator lights do not work while the appliance is running.	<ul style="list-style-type: none"> ■ Has there been a power failure? ■ Have the fuses blown/has the circuit breaker tripped? Switch on the circuit breaker/replace the fuses. ■ If the fault occurs repeatedly, call the after-sales service.
There is detergent residue on the laundry.	<ul style="list-style-type: none"> ■ Some phosphate-free detergents contain water-insoluble residue. ■ Select Rinse or brush the laundry after washing.
- P - appears on the display panel when the cycle is paused.	<ul style="list-style-type: none"> ■ The water level is too high. It is not possible to add laundry. Close the door immediately, if necessary. ■ Press the ▷ button to resume the programme.
- P - and Ⓞ appear on the display panel when the cycle is paused.	The door is unlocked. It is possible to add laundry.
If you cannot rectify a fault yourself (after switching the machine off and then on again) or a repair is required:	
<ul style="list-style-type: none"> ■ Switch off the appliance and pull the mains plug out of the socket. ■ Turn off the tap and call the after-sales service. 	



After-sales service

If you cannot rectify a fault yourself, contact customer services. → Cover page

We will always find an appropriate solution in order to avoid unnecessary visits by engineers.

Please give customer services the product number (E no.) and the production number (FD) of the appliance.

E-Nr. _____ FD _____

E no. Product number
FD Production number

You can find this information
*depending on the model:

On the inside of the door*/in the opened service flap* and on the rear of the appliance.

Trust the expertise of the manufacturer.

Contact us for assistance. By doing so, you will ensure that the repairs are carried out by trained service personnel using genuine spare parts.



Consumption rates

Energy and water consumption, programme duration and residual moisture for the main washing programmes

(approximate values)

Programme	Load	Energy consumption*	Water consumption*	Programme duration*
Cottons 20 °C	9 kg	0,25 kWh	90 l	2 ¾ h
Cottons 40 °C	9 kg	1,10 kWh	90 l	3 h
Cottons 60 °C	9 kg	1,06 kWh	90 l	2 ¾ h
Cottons 90 °C	9 kg	2,14 kWh	100 l	2 ¾ h
Easy-Care 40 °C	4 kg	0,71 kWh	64 l	2 h
Mixed Load 40 °C	4 kg	0,60 kWh	45 l	1 ¼ h
Delicates / Silk 30 °C	2 kg	0,19 kWh	37 l	¾ h
wool 30 °C	2 kg	0,19 kWh	41 l	¾ h







Programme	Approximate information on the residual moisture**			
	WAW32... Max. 1600 rpm	WAW28... Max. 1400 rpm	WAW24... Max. 1200 rpm	WAW20... Max. 1000 rpm
Cottons	44%	48%	53%	62%
Easy-Care	40%	40%	40%	40%
Delicates / Silk	30%	30%	30%	30%
Wool	45%	45%	45%	45%

* Observed values may deviate from the indicated values due to influence of water pressure, hardness and inlet temperature, ambient temperature, type, amount and soiling of laundry, detergent used, fluctuations in power supply and selected additional functions.

** Information on residual moisture based on programme-dependent spin-speed limit and maximum loads.

Efficiency test programmes for cotton fabrics

The following programmes (standard programmes, indicated by ) are suitable for cleaning normally soiled cotton fabrics and are the most efficient with respect to combined energy and water consumption.

Standard programmes for cottons in accordance with Regulation (EU) no. 1015/2010		
Programme + temperature	Load	Approximate programme duration
Cottons Eco  + 	9 kg	4 ¾ h
Cottons Eco  + 	4,5 kg	4 ½ h
Cottons Eco  + 	4,5 kg	4 ½ h

Programme setting at maximum speed for testing and energy labelling in accordance with Directive 2010/30/EU with cold water (15 °C).
The stated programme temperature is based on the temperature indicated on the care label in the laundry items. The actual washing temperature may differ from the stated programme temperature for energy-saving reasons; the washing performance corresponds to the selected temperature.

Technical data

Dimensions:

850 x 600 x 590 mm

(height x width x depth)

Weight:

70-85 kg (depending on the model)

Mains connection:

Mains voltage 220-240 V/50 Hz

Nominal current 10 A

Nominal power 1900-2300 W

Water pressure:

100-1000 kPa (1-10 bar)

Power consumption when switched off:

0,12 W

Power consumption when it is left on:

0,43 W

Power consumption when networked (Wi-Fi) in standby mode/duration:

1,1 W / 20 min



Aqua-Stop warranty

Only for appliances with Aqua-Stop

In addition to warranty claims against the vendor based on the purchase agreement and to our appliance warranty, we will provide compensation under the following conditions:

1. If water damage is caused due to a fault in our Aqua-Stop system, we will compensate domestic customers for the damage caused.
2. The liability guarantee is valid for the service life of the appliance.
3. It is a prerequisite of all warranty claims that the appliance with Aqua-Stop must have been installed and connected correctly in accordance with our instructions; this also includes a correctly fitted Aqua-Stop extension (genuine accessories). Our warranty does not cover defective feed lines or fittings leading to the Aqua-Stop connection at the tap.
4. Appliances with Aqua-Stop do not need to be supervised during operation, nor secured afterwards by turning off the tap.
The tap only needs to be turned off if you are away from home for a long period, e.g. for several weeks' holiday.



Advice and repair order in the event of faults

GB 0344 892 8979 (Calls charged at local or mobile rate.)

IE 01450 2655 (0.03 € per minute at peak. Off peak 0.0088 € per minute.)

You can find the contact information for all countries in the attached after-sales service directory.

Robert Bosch Hausgeräte GmbH
Carl-Wery-Straße 34
81739 München, GERMANY



9001269150 (9612)