



SIEMENS



Washing machine

WMH4Y890GB

siemens-home.bsh-group.com/welcome

en Instruction Manual and Installation Instructions

Register
your
product
online

Your new washing machine

You have chosen a Siemens washing machine.

Please take a few minutes to read and become familiar with the advantages of your washing machine.

To meet the high quality demands required by Siemens, every washing machine that leaves our factory is carefully checked to ensure that it functions correctly and is in perfect condition.

For more information on our products, accessories, replacement parts and services, see our website www.siemens-home.bsh-group.com or contact our after-sales service centres.

If the operating and installation instructions describe different models, any differences will be pointed out at the relevant points in the text.



Read these operating and installation instructions before switching on the washing machine.

Display rules

Warning!

This combination of symbol and signal word indicates a possibly dangerous situation. Not heeding the warning can cause death or injuries.

Caution!

This signal word indicates a possibly dangerous situation. Not heeding the caution can cause property and/or environmental damage.

Note/tip

Information about the optimum use of the appliance/any other useful information.













1. 2. 3. / a) b) c)











The steps are represented by numbers or letters.

■ / -

Lists are represented by a small box or a dash.

Contents

 Intended use	5	 Detergent	31
 Safety instructions	6	Correct selection of detergent	31
Children/people/pets	6	Saving energy and detergent	31
Installation	7	 Overview of programmes	32
Operation	10	Programmes on the programme selector	32
Cleaning/Maintenance	11	Starching	37
 Environmental protection	13	Dyeing/bleaching	37
Packaging/used appliance	13	 Programme default settings	38
Tips on economical use	13	Temperature	38
 Positioning and connecting	14	Spin speed	38
Included with the appliance	14	Finished in	38
Safety instructions	15	i-Dos settings	39
Installation surface	15	 Additional programme settings/options (* depending on the model)	40
Installation on a base or a wooden joist floor	15	speedPerfect 	40
Installation on a platform with drawer	15	ecoPerfect 	40
Installing the appliance in a kitchenette	16	Prewash *	40
Removing the transport locks	16	Extra rinse *	40
Hose and cable lengths	17	Water Plus *	40
Water inlet	18	Less ironing *	41
Water outlet	19	Soak *	41
Levelling	20	Rinse Hold *	41
Electrical connection	21	Silent Wash *	41
Before washing for the first time	22	Stains *	42
Transportation	23	 Operating the appliance	43
 Main points in brief	24	Preparing the washing machine	43
 Getting to know the appliance 25		Switching on the appliance/ selecting a programme	43
Washing machine	25	Change the programme default settings	43
Control panel	26	Select additional programme settings	44
Display panel	28	Placing laundry into the drum	44
 Laundry	30	Measure and add detergent and care products	44
Prepare the laundry	30	Start the programme	45
Sorting laundry	30	Child lock 3 sec.	45
		Adding laundry	46

Changing the programme	46
Cancel the programme	46
Programme end during rinse hold . .	46
Programme end	46
Removing laundry/switching off the appliance	47
 Intelligent dosing system	48
Intelligent dosing system in the detergent drawer	48
Initial use/filling the dispensers . . .	48
Everyday use	49
Base dosage	49
Dispenser content for i-Dos 	50
Manual dosage	51
 Home Connect	52
Calling up the Home Connect menu	52
Connecting to the home network and the Home Connect app	53
Activating/deactivating Wi-Fi	54
Resetting your network settings . . .	55
Updating the software	55
Information on data protection	56
Declaration of Conformity	56
 Appliance settings	57
 Sensors	58
Automatic load sensing	58
Unbalanced load detection system .	58
AquaSensor	58
Load sensor/display	58
Dosing recommendation	58
 Cleaning and maintenance	59
Machine housing/control panel	59
Drum	59
Descaling	59
i-Dos detergent draw and its housing	60
The drain pump is blocked, emergency draining	61
The drain hose at the siphon is blocked	62
Filter in the water supply blocked . .	62
 Faults and what to do about them	63
Emergency release	63
Information on the display panel . . .	64
Faults and what to do about them . .	65
 After-sales service	68
 Consumption rates	69
Energy and water consumption, programme duration and residual moisture for the main washing programmes	69
Efficiency test programmes for cotton fabrics	70
 Technical data	70
 Aqua-Stop warranty	71



Intended use

- This appliance is intended for private domestic use only.
- Do not install or operate this appliance anywhere that is liable to experience frost and/or outdoor conditions. There is a risk that the appliance will be damaged if residual water in it freezes. If hoses freeze up, they may crack/burst.
- This appliance must only be used for washing domestic laundry, consisting of machine-washable items and hand-washable woollens (see label on item). Using the appliance for any other purpose is outside of the scope of its intended application and is forbidden.
- This appliance is suitable for operation with mains water and commercially available detergents and care products (must be suitable for use in washing machines).
- This appliance is intended for use up to a maximum height of 4000 metres above sea level.

Before you switch on the appliance:

Check that there is no visible damage to the appliance. Do not operate the appliance if it is damaged. Should you have any problems, please contact your specialist dealer or our customer service.

Read and follow the operating and installation instructions and all other information provided with this appliance.

Retain the documents for subsequent use or for subsequent owners.

Safety instructions

The following safety information and warnings are provided to protect you from injury and to prevent material damage to your surroundings.

It is nevertheless important to take the necessary precautions and to proceed with care when installing, maintaining, cleaning and operating the appliance.

Children/people/pets

Warning **Risk of death!**

Children and other people who are unable to assess the risks involved when using the appliance may injure themselves or may find themselves in life-threatening situations. Therefore please note:

- The appliance may be used by children over the age of 8 years and by persons with reduced physical, sensory or mental capacity or by persons with a lack of experience or knowledge as long as they are supervised or have received instruction on how to use the appliance safely and they have understood the potential risks of using the appliance.
- Children must not play with this appliance.

- Do not allow children to clean or maintain this appliance unsupervised.
- Keep children under 3 years and pets away from this appliance.
- Do not leave the appliance unattended when children or other people who are unable to assess the risks are in the vicinity.

Warning **Risk of death!**

Children may lock themselves inside appliances and find themselves in a life-threatening situation.

- Do not position the appliance behind a door, as this may obstruct the appliance door or prevent it from opening completely.
- Once an appliance has reached the end of its life, pull the mains plug from the socket **before** severing the mains cable, and then destroy the lock on the appliance door.

⚠ Warning**Risk of suffocation!**

If allowed to play with the packaging/plastic film or packing components, children may become caught in these or pull them over their heads and suffocate.

Keep packaging, plastic film and packing components away from children.

⚠ Warning**Risk of poisoning!**

Detergents and care products may result in poisoning if consumed.

If accidentally swallowed, seek medical advice. Keep detergents and care products out of the reach of children.

⚠ Warning**Risk of burns!**

When washing at high temperatures, the glass in the appliance door becomes hot. Stop children from touching the appliance door when it is hot.

⚠ Warning**Eye/skin irritation!**

Contact with detergents or care products may cause eye/skin irritation.

Rinse eyes/skin thoroughly if they/it come(s) into contact with detergents or care products. Keep detergents and care products out of the reach of children.

Installation**⚠ Warning****Risk of electric shock/fire/material damage/damage to the appliance!**

If the appliance is not installed properly, this may lead to a dangerous situation. Ensure the following:

- The mains voltage on your power socket must match the rated voltage specified on the appliance (identification plate). The connected loads and the required fuse protection are specified on the identification plate.
- The mains plug and the protective contact socket must match and the earthing system must be correctly installed.
- The installation must have an adequate cross section.
- The mains plug must be freely accessible at all times. If this is not possible, in order to comply with the relevant safety regulations, a switch (all pole disconnection) must be built into the permanent installation in accordance with electrical installation regulations.

- If using a residual current circuit breaker, only use one that bears the following mark: . The presence of this mark is the only way to be sure that it fulfils all the applicable regulations.

 Warning
**Risk of electric shock/fire/
material damage/damage to
the appliance!**

If the appliance's mains cable is altered or damaged, this may result in electric shock, short circuiting or fire due to overheating.

The mains cable must not be kinked, crushed or altered, and must not come into contact with any heat sources.

 Warning
**Risk of fire/material damage/
damage to the appliance!**

The use of extension cords or power strips may result in fire due to overheating or short circuiting.

Connect the appliance directly to an earthed socket that has been correctly installed. Do not use extension cords, power strips or multi-way couplers.

 Warning
**Risk of injury/material
damage/damage to the
appliance!**

- The appliance may vibrate or move when in operation, potentially resulting in injury or material damage. Place the appliance on a clean, even, solid surface and, using a spirit level to guide you, level it with the screw-in feet.
- If you take hold of any of the appliance's protruding parts (e.g. the appliance door) in order to lift or move it, these parts may break off and cause injury. Do not take hold of any of the appliance's protruding parts in order to move the appliance.

⚠ Warning**Risk of injury!**

- The appliance is very heavy. Lifting it may result in injury. Do not lift the appliance on your own.
- The appliance has sharp edges on which you could cut your hands. Do not take hold of the appliance by its sharp edges. Wear protective gloves to lift it.
- If the hoses and mains cables are not correctly routed, they may constitute a tripping hazard, which may result in injury. Route hoses and cables such that they do not constitute a tripping hazard.

Caution!**Material damage/damage to the appliance**

- If the water pressure is too high or too low, the appliance may not be able to operate properly, and it may also result in material damage or damage to the appliance. Make sure that the water pressure in the water supply facility is at least 100 kPa (1 bar), and does not exceed 1000 kPa (10 bar).

- If the water hoses are altered or damaged, this may result in material damage or damage to the appliance. The water hoses must not be kinked, crushed, altered or severed.
- The use of hoses supplied by other brands to connect to the water supply may result in material damage or damage to the appliance. Use the hoses supplied with the appliance or genuine spare part hoses only.
- The appliance is secured for transportation by transport locking devices. If the transport locking devices are not removed before the appliance is operated, this may result in damage to the appliance. It is important to completely remove all transport locking devices before using the appliance for the first time. Make sure that you retain these transport locking devices separately. It is important to refit the transport locking devices if the appliance is to be transported, in order to prevent the appliance from being damaged in transit.

Operation

Warning

Risk of explosions/fire!

Laundry that has been pretreated with cleaning agents that contain solvents, e.g. stain remover/cleaning solvent, may cause an explosion in the drum. Rinse the laundry thoroughly with water before washing it in the machine.

Warning

Risk of poisoning!

Poisonous fumes may be given off by cleaning agents that contain solvents, e.g. cleaning solvent.

Do not use cleaning agents that contain solvents.

Warning

Risk of injury!

- If you support your weight/sit on the appliance door when it is open, the appliance may tip over, which may result in injury.

Do not support your weight on the appliance door when it is open.

- If you climb onto the appliance, the worktop may break, which may result in injury.

Do not climb onto the appliance.

- If you reach into the drum while it is still rotating, you risk injuring your hands. Wait until the drum has stopped rotating.

Warning

Risk of scalding!

When washing at high temperatures, there is a risk of scalding if you come into contact with hot detergent solution (e.g. when draining hot detergent solution into a washbasin).

Do not reach into the hot detergent solution.

Warning

Eye/skin irritation!

Detergent and care products may spray out if the detergent drawer is opened while the appliance is in operation.

Rinse eyes/skin thoroughly if they/it come(s) into contact with detergents or care products. If accidentally swallowed, seek medical advice.

Caution!**Material damage/damage to the appliance**

- If the amount of laundry in the appliance exceeds its maximum load capacity, it may not be able to operate properly, or this may result in material damage or damage to the appliance.
Do not exceed the maximum load capacity of dry laundry. Make sure you comply with the maximum load capacities specified for each of the programs. → *Page 32*
- If you pour the wrong quantity of detergent or cleaning agent into the appliance, this may result in material damage or damage to the appliance.
Use detergents/care products/cleaning agents and softeners in accordance with the manufacturers' instructions.

Cleaning/Maintenance** Warning
Risk of death!**

The appliance is powered by electricity. There is a risk of electric shock if you come into contact with live components. Therefore please note:

- Switch off the appliance. Disconnect the appliance from the power supply (pull out the plug).

- Never take hold of the mains plug with wet hands.
- When removing the mains plug from the socket, always take hold of the plug itself and never the mains cable, otherwise this may damage the mains cable.
- Do not make any technical modifications to the appliance or its features.
- Repairs and any other work on the appliance must only be conducted by our customer service or by an electrician. The same applies for replacing the mains cable (when necessary).
- Spare mains cables can be ordered from our customer service.

** Warning
Risk of poisoning!**

Poisonous fumes may be given off by cleaning agents that contain solvents, e.g. cleaning solvent.
Do not use cleaning agents that contain solvents.

** Warning
Risk of electric shock/material damage/damage to the appliance!**

If moisture penetrates the appliance, this may cause it to short circuit.
Do not use a pressure washer, steam cleaner, hose or spray gun to clean your appliance.

 **Warning**

Risk of injury/material damage/damage to the appliance!

The use of spare parts and accessories supplied by other brands is dangerous and may result in injury, material damage or damage to the appliance.

For safety reasons, use genuine spare parts and accessories only.

Caution!

Material damage/damage to the appliance

Cleaning agents and agents for pretreating laundry (e.g. stain removers, prewash sprays, etc.) may cause damage if they come into contact with the surfaces of the appliance.

Therefore please note:

- Do not allow these agents to come into contact with the surfaces of the appliance.
- Clean the appliance with nothing but water and a soft, damp cloth.
- Remove any detergent, spray or other residues immediately.



Environmental protection

Packaging/used appliance



Dispose of packaging in an environmentally-responsible manner.

This appliance is labelled in accordance with European Directive 2012/19/EU concerning used electrical and electronic appliances (waste electrical and electronic equipment - WEEE).

The guideline determines the framework for the return and recycling of used appliances as applicable throughout the EU.

Tips on economical use



- Always fill the appliance with the maximum amount of laundry for each programme.
→  *Overview of programmes" on page 32*
- Wash normally soiled laundry without prewash.
- For light and normal soiling in laundry, you can save energy and detergent. → *Page 31*
- Dosing the detergent using the **intelligent dosing system** (i-Dos) helps to save both detergent and water.
- The selectable temperatures apply to the care labels on the textiles. The temperatures in the machine may deviate from this so that you get the optimum mix of energy-saving and washing results.

- **Information on energy and water consumption:** → *Page 28*
The displays provide information about the relative level of energy and water consumption in the selected programmes.

The more display segments are visible, the higher the respective consumption.

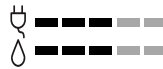
This enables you to compare the consumption levels of the different programmes when choosing your programme settings and decide on an energy- and water-saving programme setting.



-  Energy consumption
-  Water consumption

- **Energy-saving mode:** The display panel lighting goes out after a few minutes and the ►|| button flashes. Press any button to activate the lighting.
Energy-saving mode is not activated if a programme is running.
- **Automatic switch off:** If the appliance is not operated for a prolonged period, it may automatically switch off before the programme starts and when the programme has ended to save energy. Press the main switch again to switch on the appliance.
→  *Appliance settings" on page 57*
- If the washing will be dried in a dryer, select the spin speed according to the dryer manufacturer's instructions.



Positioning and connecting

Included with the appliance

Note: Check the machine for transport damage. Never use a damaged machine. If you have any complaints, contact the dealer from whom you purchased the appliance or our customer services. → Page 68

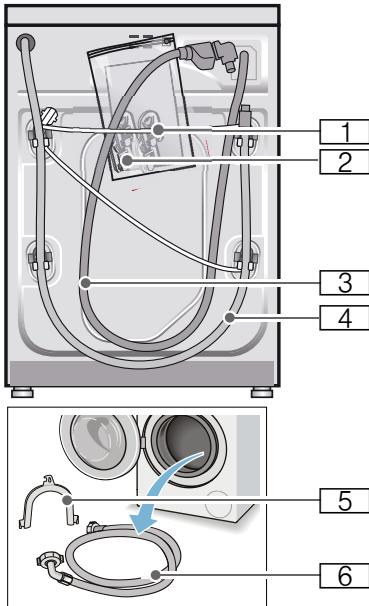

- 1 Mains cable
 - 2 Bag:
 - Installation and operating instructions
 - Customer services location directory*
 - Warranty*
 - Cover caps for openings after the transport braces have been removed
 - Adaptor with sealing washer from 21 mm = 1/2" to 26.4 mm = 3/4" *
 - 3 Water supply hose on Aqua-Stop models
 - 4 Water drain hose
 - 5 Elbow for securing the water drain hose*
 - 6 Water supply hose on standard/ Aqua-Secure models
- * depending on the model

In addition, a hose clamp (24 - 40 mm diameter, available from specialist dealers) is required to connect the water drain hose to a siphon.

Useful tools

- Spirit level for aligning
- Spanner with:
 - WAF13 for loosening the transport braces, and
 - WAF17 for aligning the appliance feet

Safety instructions

Warning

Risk of injury!

- The washing machine is very heavy. Be careful when lifting/transporting the washing machine.
- When the washing machine is lifted by its protruding parts (e.g. the washing machine door), the components may break off and cause injuries. Do not lift the washing machine by protruding parts.
- If the hose and mains cables are not routed properly, there is a risk of tripping and injury. Lay hoses and cables in such a way that there is no risk of tripping.

Caution!

Damage to the appliance

Frozen hoses may rip/burst. Do not install the washing machine in areas exposed to frost or outdoors.

Caution!

Water damage

The connection points for the water supply hose and water drain hose are under high water pressure. To prevent leaks and water damage, you must follow the instructions in this section.

Notes

- In addition to the safety information listed here, the local water and electricity supplier may have special requirements.
- If in doubt, have the appliance connected by a specialist.

Installation surface

Note: The washing machine be stable so that it does not move around.

- The installation surface must be firm and level.
- Soft floors/floor coverings are not suitable.

Installation on a base or a wooden joist floor

Caution!

Damage to the appliance

The washing machine may "wander" and tip/topple from the base when spinning.

The feet of the appliance must be secured with holding brackets. Order no. WMZ 2200, WX 9756, Z 7080X0

Note: On wooden joist floors, install the washing machine:

- In a corner, if possible,
- On a water-resistant wooden board (min. 30 mm thick) which is screwed tightly to the floor.

Installation on a platform with drawer

Platform order no.: WMZ 20490, WZ 20490, WZ 20510, WZ 20520

Installing the appliance in a kitchenette

Warning **Danger of death!**

There is a risk of electric shock if you touch live components.
Do not remove the appliance covering plate.

Notes

- Recess width of 60 cm required.
- Only install the washing machine underneath a continuous worktop that is securely connected to adjacent cabinets.

Removing the transport locks

Caution! **Damage to the appliance**

- The machine is secured for transportation using transport locks. If the transport locks are not removed, the drum, for example, may become damaged when the machine is operated. Before using the appliance for the first time, make sure that you completely remove all four transport locks. Keep the locks in a safe place.
- To prevent transport damage from occurring if the appliance is moved at a later date, you must refit the transport locks before transporting the appliance.

Note: Keep the screws and sleeves in a safe place.

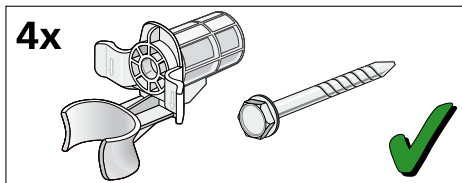

1. Take the hoses out of the holders.

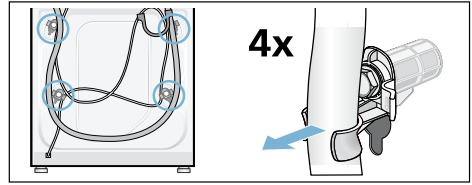

2. Unscrew and remove all four transportation securing bolts with a wrench (WAF 13). Remove the sleeves. Remove the mains cable from the holders.

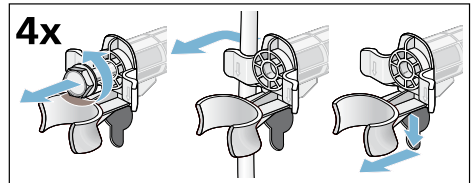

3. Insert the covers. Lock the covers firmly in place by applying pressure to the snap-in hooks.

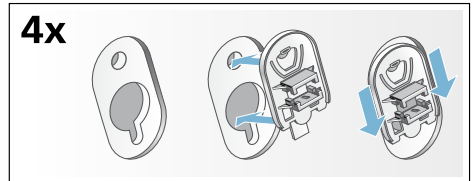

Hose and cable lengths

■ Left-hand connection

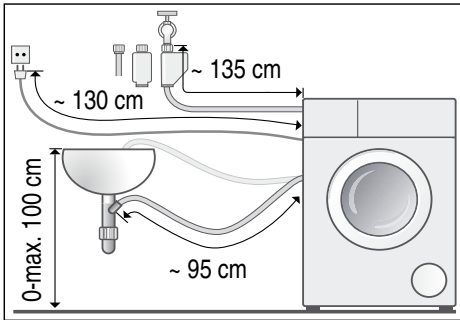

■ Right-hand connection

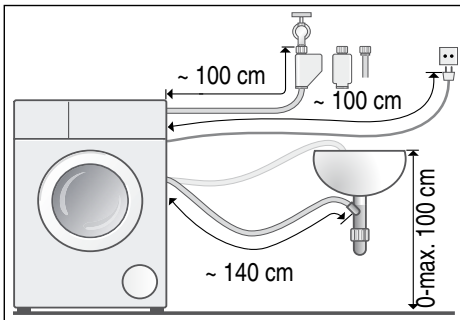

Tip: The following are available from specialist dealers/customer services:

- Extension for Aqua-Stop and cold water supply hose (approx. 2.50 m); order no. WM Z2380, WZ 10130, CZ 11350, Z 7070X0
- A longer supply hose (approx. 2.20 m) for standard models; individual component number for customer services: 00353925

Water inlet

Warning **Danger of death!**

There is a risk of electric shock if you touch live components.
Do not immerse the Aqua-Stop safety valve in water (it contains an electric valve).

Notes

- Only operate the washing machine using cold mains water.
 - Do not connect the machine to the mixer tap of an unpressurised hot-water boiler.
 - Do not use a used supply hose. Only use the supply hose supplied or one that was purchased from an authorised specialist retailer.
 - Do not kink or squash the water supply hose.
 - Do not alter (shorten, cut through) the water supply hose (otherwise its strength is no longer guaranteed).
 - Only tighten the screw connections by hand. If the screw connections are tightened too much with a tool (pliers), the thread may become damaged.
 - When connecting to a 21 mm = 1/2" tap, first fit an adapter* with a sealing washer from 21 mm = 1/2" to 26.4 mm = 3/4".
- *supplied depending on the model

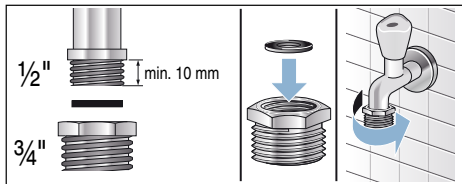

Optimum water pressure in the supply network

At least 100 kPa (1 bar)

Maximum 1000 kPa (10 bar)

When the tap is open, the water flow rate is at least 8 l/min.

If the water pressure is higher than this, a pressure-reducing valve must be installed.

Connection

Connect the water supply hose to the tap (26.4 mm = 3/4") and to the appliance (not necessary for Aqua-Stop models as this is permanently installed):

- Model: **Standard**

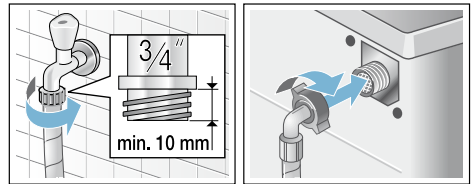

- Model: **Aqua-Secure**

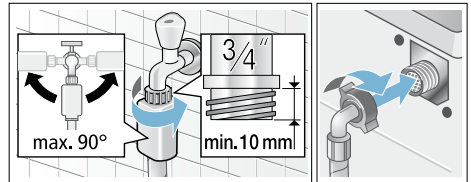

- Model: **Aqua-Stop**

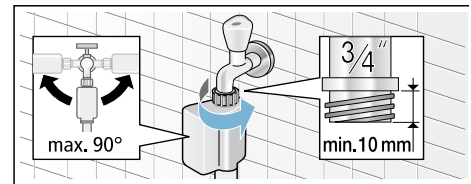

Note: Turn on the tap carefully, checking the leak tightness of the connection points. The screw connection is under mains water pressure.

Water outlet

Warning

Risk of scalding!

When you are washing at high temperatures, there is a risk of scalding if you come into contact with hot water (e.g. when draining hot water into a washbasin).

Do not reach into the hot water.

Caution!

Water damage

If the drain hose slips out of the washbasin or the connection point during draining due to high water pressure, any escaping water may cause water damage.

Secure the drain hose so that it cannot slip out.

Caution!

Damage to the appliance/fabrics

If the end of the drain hose is immersed in the drained water, water may be sucked back into the appliance and may damage the appliance/fabrics.

Make sure that:

- The plug does not block drainage from the washbasin.
- The end of the drain hose is not immersed in the drained water.
- The water drains away quickly enough.

Note: Do not kink the water drain hose or put strain on it lengthways.

Connection

■ Drainage into a washbasin

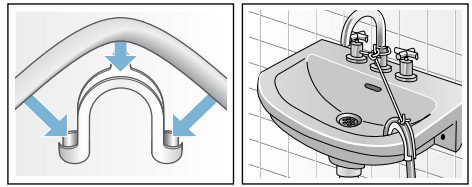

■ Drainage into a siphon

The connection point must be secured using a hose clamp with a diameter of 24 - 40 mm (available from specialist dealers).

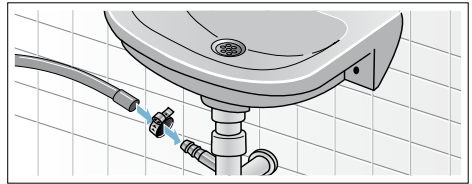

■ Drainage into a plastic pipe with rubber bushing or into a drainage pit

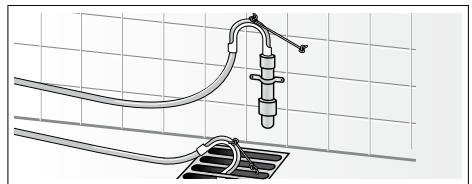

Levelling

Align the appliance using a spirit level.

Incorrect alignment may result in loud noises, vibrations and machine "movement".

1. Loosen the lock nuts using a WAF17 spanner, by turning it in a clockwise direction.
2. Check the alignment of the washing machine with a spirit level, and adjust it if necessary. Change the height by turning the appliance feet. All four appliance feet must stand firmly on the ground.
3. The lock nuts on all four appliance feet must be screwed tightly against the housing using a suitable WAF17 spanner. In doing so, hold the foot tight and do not adjust its height.

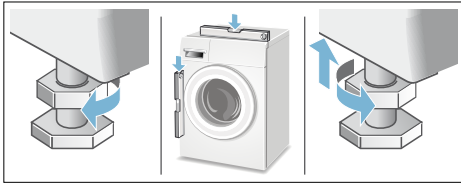

Electrical connection

Warning

Danger of death!

There is a risk of electric shock if you touch live components.

- Never touch or hold the mains plug with wet hands.
- Only pull out the mains cable by the plug and never by the cable, as this could damage it.
- Never unplug the mains plug during operation.

Observe the following information and ensure that:

Notes

- The mains voltage and voltage indicated on the washing machine (rating plate) are the same. The connected load and fuse required are specified on the rating plate.
- The washing machine is only connected to an alternating current supply via a properly installed earthed socket.
- The mains plug fits the socket.
- The cable cross-section is adequate.
- The earthing system is properly installed.
- The mains cable is only replaced by a qualified electrician (if this is necessary). Replacement mains cables are available from customer services.
- No multiple plugs/couplings or extension cables are used.
- If an earth-leakage circuit breaker is used, only a type which displays the  symbol is used. Only this symbol guarantees compliance with the currently applicable regulations.

- The mains plug can be accessed at all times. If this is not possible, in order to comply with the relevant safety regulations, a switch (2-pole switch-off) must be built into the permanent installation in accordance with electrical installation regulations.
- The mains cable is not kinked, squashed, altered or cut through.
- The mains cable does not come into contact with heat sources.



Before washing for the first time

The washing machine was thoroughly tested before leaving the factory. To remove any water that may be left over from the test, run the first wash cycle **without** any laundry.





Notes

- The washing machine **must be correctly installed and connected.** (from → *Page 14*)
- Never use a damaged machine. Inform the after-sales service.

Preparatory work:

1. Check the machine.
2. Fill the dispenser  and . → *Page 48*
3. Remove the protective film from the control panel.
4. Plug into the mains.
5. Turn on the tap.

Run the programme without laundry:

1. Switch on the appliance.
2. Close the door (do not load any laundry).
3. Set the **Drum clean 90 °C** programme.
4. Open the detergent drawer.
5. Pour approx. 1 litre of water into compartment  .
6. Pour standard washing powder into compartment  .
- Note:** To prevent foaming, only use half of the amount of detergent recommended by the detergent manufacturer. Do not use detergents that are intended for wool or delicates.
7. Close the detergent drawer.
8. Press the  button.
9. Switch off the appliance at the end of the programme.

Your washing machine is now ready to use.

Transportation

E.g. when moving house

Caution!

Risk of damage to the appliance caused by detergent/fabric softener leaking from the dispensers.

Leaking detergent/fabric softener can prevent the appliance from working correctly, e.g. due to damage to the electronics.

Empty the dispensers before transporting the appliance.

Preparatory work:

1. Turn off the tap.
2. Reduce the water pressure in the supply hose: → *Page 62*; cleaning and maintenance – filter in the water supply clogged
3. Disconnect the washing machine from the mains.
4. Drain any residual water: → *Page 61*; cleaning and maintenance – drain pump blocked, emergency draining
5. Remove the hoses.
6. Empty the dispensers. → *Page 60*

Fitting the transportation securing means:

1. Remove the covers and keep them in a safe place.
If required, use a screwdriver.

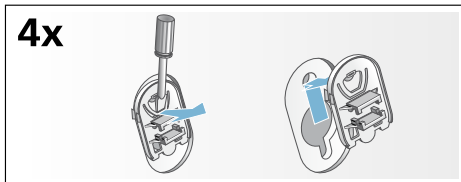

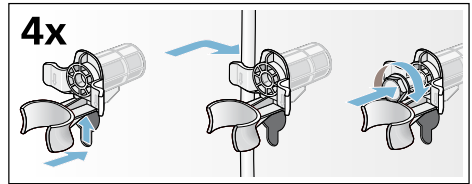

2. Insert all four sleeves.
Clip the mains cable securely in the holders. Insert the transportation securing bolts and tighten them with a wrench (WAF 13).



Before switching on the appliance again:

Notes

- **Always** remove the transport braces.
- To prevent unused detergent from flowing straight into the drain during the next wash: Pour approx. 1 litre of water into compartment   and start the **Drain** programme.

Main points in brief

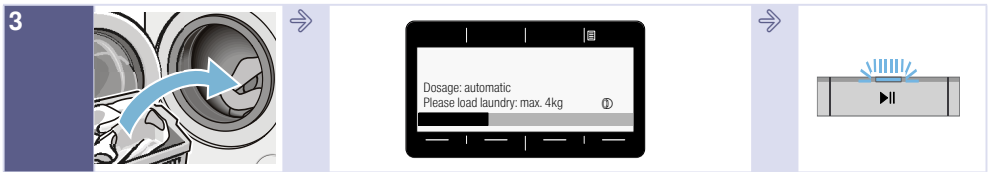
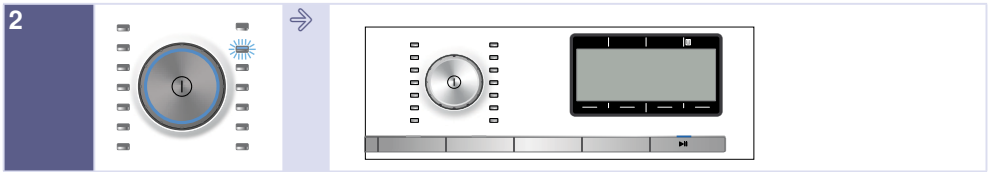
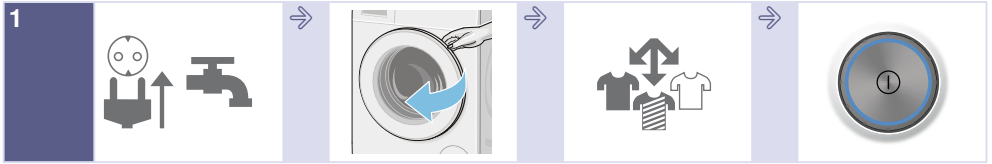

Getting to know the appliance

Washing machine

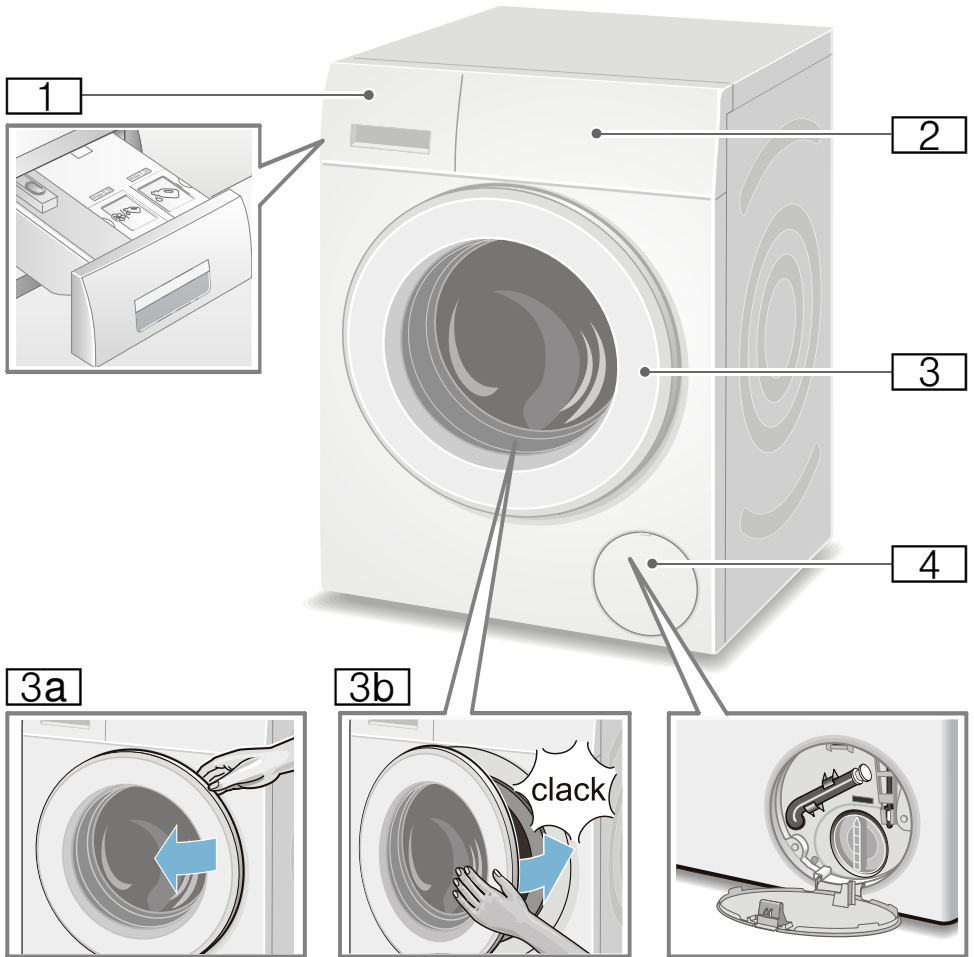

1 Detergent drawer with illuminated displays for the i-Dos dispenser on the drawer handle
→ Page 48

2 Operating/display panel

3 Loading door with door handle

3a Open the loading door

3b Close the loading door

4 Service flap

Control panel

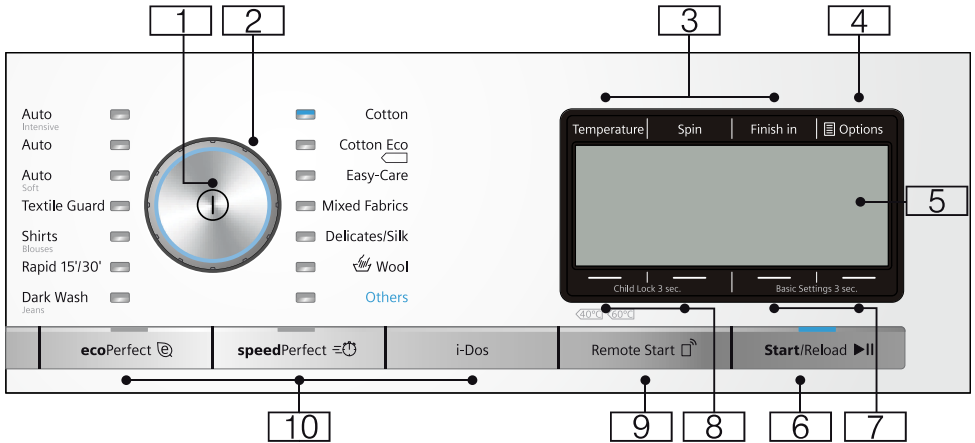

Note: All the buttons are sensitive (except for the main switch) and only need to be pressed lightly.

- 1 **Main switch**
To switch the appliance on/off:
Press the ① button.
- 2 **Programme selector**
For selecting a programme.
The programme selector can be turned in either direction.
Programme overview
→ Page 32
- 3 **Buttons for changing the programme default settings:**
→ Page 38
 - Temperature ,
 - Spin speed (Spin),
 - Finished in
- 4 Options → Page 29,
→ Page 40
- 5 **Display panel** for settings and information
- 6 **▶|| button for:**
 - Starting a programme,
 - Interrupting a programme, e.g. to add items of laundry
→ Page 46,
 - Cancelling a programme



- 7 Buttons **Basic settings 3 sec.** for changing the appliance settings, e.g. button signals, an overview of all selectable settings that can be selected
→ Page 29,
- 8 Buttons **Child lock 3 sec.** for activating/deactivating the childproof lock
→ Page 45

- 9 The **Remote start**  button releases the appliance so that the programme can be started remotely via the Home Connect app. Remote start remains enabled for 24 hours after it has been activated. It is automatically deactivated if you do not start the programme via the Home Connect app during this time. If you carry out any operations on the appliance itself, such as opening the door or selecting a different programme, the remote start button is deactivated for safety reasons.

Notes

- Remote start can only be activated if the door is closed.
- Remote start cannot be activated if the childproof lock is on.

Press and hold the button for more than three seconds to access the Home Connect settings .

- 10 **Buttons for selecting additional programme settings**
ecoPerfect , speedPerfect ,
i-Dos → *Page 32*

en Getting to know the appliance

Display panel

Main menu after selecting the programme

e.g. **Easy-Care**

The arrows on the display panel indicate in which direction the programme default settings can be changed using the buttons located above and below.

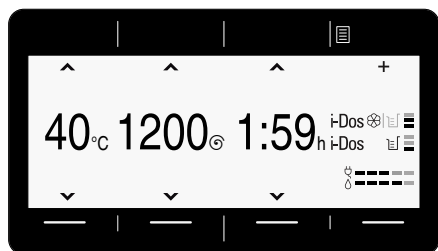

... Others Programmes selected

and select, for example, the **Spin** programme:

Using the buttons below the arrows, you can select the required programme. The selection is acknowledged by a tick.

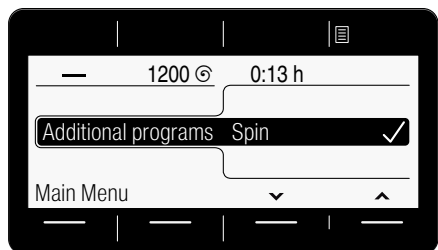

Wait or go back by pressing the **Main menu** button; the selected programme is displayed on the display panel.

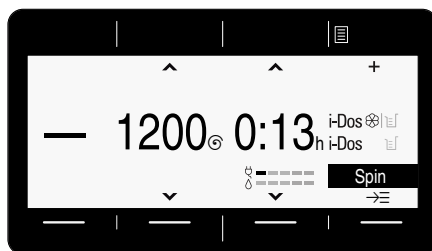

To change, select the button under the programme highlighted in black and change the programme.

Use the i-Dos button to select the dispenser and the dosage quantity

Press the **i-Dos** button.

Use the buttons below the two left-hand arrows to select the required dispenser, e.g. **i-Dos**.

Use the buttons below the two right-hand arrows to select the required dosage quantity, e.g. **Medium** for the detergent. The selection is acknowledged by a tick.

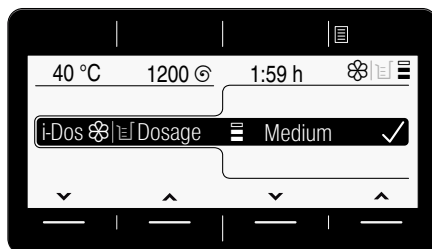



Wait or go back to the main menu by pressing the **i-Dos** button.

Options  **button selected**

and select, for example, the **Rinse Hold**  option:

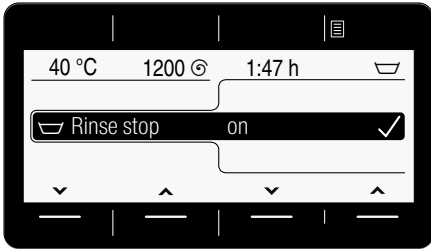
Using the buttons under the two left-hand arrows, select the option. Using the two right-hand arrows, select the displayed value. The selected options are active immediately and are displayed on the display panel.



Wait or go back to the main menu by pressing the **Options**  button.

Basic settings 3 sec. buttons selected

Change the appliance setting; e.g. volume of the **end signal** → *Page 57*

Using the buttons under the two left-hand arrows, select the setting. Using the two right-hand arrows, select the displayed value. The selection is acknowledged by a tick.

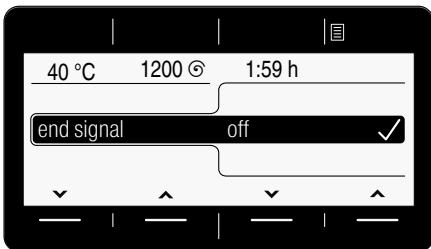

Wait or go back to the main menu by pressing the **Basic settings 3 sec.** (press and hold again).



Laundry

Prepare the laundry

Caution!

Damage to the appliance/fabrics

Foreign objects (e.g. coins, paperclips, needles, nails) may damage the laundry or components in the washing machine.

You should therefore note the following tips when preparing your laundry:

- Empty any pockets.

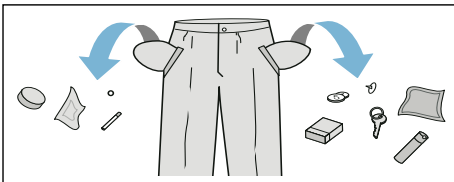

- Look out for metal items (paperclips, etc.) and remove them.
- Wash delicates in a laundry bag (tights, underwired bras, etc.).
- Close any zips; button up any cover buttons.
- Brush sand out of pockets and collars.
- Remove curtain fittings or place curtains in a laundry bag.

Sorting laundry

Sort your laundry according to the care instructions and manufacturer's information on the care labels, depending on:







- Type of fabric/fibre
- Colour
 - Note:** Laundry may discolour. Wash white and coloured items separately. Wash new coloured items separately the first time you wash them.
- Soiling
 - Wash laundry with the same level of soiling together.

Some examples of soiling levels can be found on → Page 31

- **Light:** Do not prewash, select the **speedPerfect**  setting if necessary
- **Normal**
- **Heavy:** Load less laundry, select a programme with prewash
- **Stains:** Remove/pretreat stains while they are fresh. Firstly, dab with soapy water; do not rub. Then wash the items of laundry with the appropriate programme. Stubborn or dried-in stains can sometimes only be removed by washing several times.

- Symbols on the care labels

Note: The numbers in the symbols indicate the maximum washing temperature that may be used.

-  Suitable for normal washing process; e.g. Cottons programme
-  A gentle washing process is required; e.g. Easy-Care programme
-  An especially gentle washing process is required; e.g. Delicate/Silk programme
-  Suitable for washing by hand; e.g.  Woollens programme
-  Do not machine wash.

Detergent

Correct selection of detergent

The care label is crucial for selecting the correct detergent, temperature and treatment of the laundry. → See also www.sartex.ch

If you visit www.cleanright.eu, you will find further information on detergents, care products and cleaning agents for domestic use.

- **Standard detergent with optical brighteners**

Suitable for boil-washable white laundry made from linen or cotton
Programme: Cottons/
cold - max. 90 °C

- **Detergent for colours without bleach or optical brighteners**

Suitable for coloured laundry made from linen or cotton
Programme: Cottons/
cold - max. 60 °C

- **Detergent for colours/delicates without optical brighteners**

Suitable for coloured laundry made from easy-care fibres, synthetic fibres
Programme: Easy-Care/
cold - max. 60 °C

- **Detergent for delicates**

Suitable for delicate, fine fabrics, silk or viscose
Programme: Delicate/Silk/
cold - max. 40 °C

- **Detergent for woollens**

Suitable for wool
Wool programme/
cold - max. 40 °C

Saving energy and detergent

For light and normal soiling, you can save energy (lower washing temperature) and detergent.

Saving	Soiling/note
Reduced temperature and detergent quantity as per the recommended dosage	Light No visible dirt or stains. Clothing has taken on some body odour, e.g.: <ul style="list-style-type: none"> ■ Light summer/sports clothing (worn for a few hours) ■ T-shirts, shirts, blouses (worn for up to one day) ■ Guest bed linen and hand towels (used for one day)
	Normal Visible dirt or a few light stains, e.g.: <ul style="list-style-type: none"> ■ T-shirts, shirts, blouses (sweat soaked, worn a few times) ■ Towels, bedding (used for up to one week)
	Heavy Dirt and/or stains clearly visible, e.g. tea towels, baby items, work clothing
Temperature as per the care label and detergent quantity as per the recommended dosage for heavy soiling	





































Note: When measuring the amount of all detergents/additives/care products and cleaning agents, please always check the manufacturer's instructions and information. → *Page 44*



























Overview of programmes























Programmes on the programme selector

Programme/type of laundry/instructions	Settings
<p>Name of the programme</p> <p>Brief explanation of the programme and the fabrics for which it is suitable.</p>	<p>Max. load</p> <p>Temperature that can be selected; (☹️ = cold)</p> <p>Spin speed that can be selected; 0 = no spin cycle, draining only</p> <p>Additional programme settings that can be selected*</p> <p>Possible automatic dosing:</p> <ul style="list-style-type: none"> ■ Of a liquid detergent (🧼) and ■ of a fabric softener (🌀) <p>can be selected/deselected ✓, cannot be selected -</p>
<p>Cotton</p> <p>Hard-wearing fabrics, heat-resistant fabrics made of cotton or linen</p> <p>Notes</p> <ul style="list-style-type: none"> ■ In the ecoPerfect (🌿) setting, the washing temperature is lower than the selected temperature. If you want to achieve a higher water temperature, use the programme without the ecoPerfect (🌿) setting, and with a higher temperature as required. ■ The speedPerfect (⚡) setting is suitable as a short programme for lightly soiled laundry. 	<p>Max. 9 kg/5*** kg</p> <p>☹️-90 °C</p> <p>0-1600** rpm</p> <p>🌿, ⚡, 🧼, 🌀, 🧺, 🧺, 🧺, 🧺, 🧺, 🧺, 🧺, 🧺</p> <p>Detergent ✓, fabric softener ✓</p>
<p>Cotton Eco (◀️)</p> <p>Hard-wearing fabrics, heat-resistant fabrics made of cotton or linen; Energy-optimised washing by reducing the temperature while achieving a comparable washing result for the Cotton programme.</p> <p>Note: . The actual washing temperature may differ from the stated programme temperature for energy-saving reasons; the washing performance corresponds to the selected temperature.</p>	<p>Max. 9 kg</p> <p>☹️-90 °C</p> <p>0-1600** rpm</p> <p>🌿, 🌀, 🧺, 🧺, 🧺, 🧺, 🧺, 🧺, 🧺</p> <p>Detergent ✓, fabric softener ✓</p>
<p>* The programmes and additional programme settings are model-dependent. The programmes/settings that are available can either be selected directly in the control panel or under ... Others Programmes or Options 📄.</p> <p>** Max. The maximum spin speed depends on the model and programme</p> <p>*** Reduced load for the speedPerfect (⚡) setting</p>	

Programme/type of laundry/instructions	Settings
<p>Easy-Care</p> <p>Textiles made of synthetic materials or blended fabrics</p>	<p>Max. 4 kg</p> <p> - 60 °C</p> <p>0-1200** rpm</p> <p> </p> <p>Detergent ✓, fabric softener ✓</p>
<p>Mixed Fabrics</p> <p>Mixed load of cottons and synthetic fabrics</p>	<p>Max. 4 kg</p> <p> 40 °C</p> <p>0-1600** rpm</p> <p> </p> <p>Detergent ✓, fabric softener ✓</p>
<p>Delicates / Silk</p> <p>Delicate, washable fabrics, e.g. made of silk, satin, synthetic fibres or blends (e.g. silk blouses, silk scarves)</p> <p>Note: . Use a detergent suitable for machine washing delicate fabrics or silk.</p>	<p>Max. 2 kg</p> <p> 40 °C</p> <p>0-800** rpm</p> <p> </p> <p>Detergent ✓, fabric softener ✓</p>
<p> Wool</p> <p>Hand- or machine-washable fabrics that are made of wool or contain wool;</p> <p>particularly gentle wash programme to prevent laundry from shrinking, with longer pauses in the programme (during which the items rest in the water)</p> <p>Notes</p> <ul style="list-style-type: none"> ■ Wool is of animal origin, e.g. angora, alpaca, llama, sheep. ■ Use a detergent that is suitable for machine-washing wool. 	<p>Max. 2 kg</p> <p> - 40 °C</p> <p>0-800** rpm</p> <p> </p> <p>Detergent -, fabric softener ✓</p>
<p>Hygiene</p> <p>Hard-wearing fabrics made of cotton or linen</p> <p>Note: . Particularly suitable for strict hygiene requirements or particularly sensitive skin thanks to the extended wash cycle at a defined temperature, higher water level and extended rinse cycle.</p>	<p>Max. 6,5kg</p> <p> - 60 °C</p> <p>0-1600** rpm</p> <p> </p> <p>Detergent ✓, fabric softener ✓</p>
<p>* The programmes and additional programme settings are model-dependent. The programmes/settings that are available can either be selected directly in the control panel or under ... Others Programmes or Options .</p> <p>** Max. The maximum spin speed depends on the model and programme</p> <p>*** Reduced load for the speedPerfect setting</p>	

Programme/type of laundry/instructions	Settings
<p>Rapid 15'/30' *</p> <p>Extra-short programme of approx. 15 / 30 minutes, suitable for small items of lightly soiled laundry</p> <p>Note: . The Rapid 15' programme is run for the speedPerfect  setting.</p>	<p>Max. 2 / 3,5 kg</p> <p> - 40 °C</p> <p>0-1200** rpm</p> <p>  </p> <p>Detergent ✓, fabric softener ✓</p>
<p>Rapid 15' *</p> <p>Extra-short programme of approx. 15 minutes, suitable for small items of lightly soiled laundry</p>	<p>Max. 2 kg</p> <p> - 40 °C</p> <p>0-1200** rpm</p> <p> </p> <p>Detergent ✓, fabric softener ✓</p>
<p>Dark wash / Jeans</p> <p>Dark-coloured cottons and dark-coloured easy-care fabrics; Turn items inside-out before washing.</p>	<p>Max. 3.5 kg</p> <p> - 40 °C</p> <p>0-1200** rpm</p> <p>      </p> <p> </p> <p>Detergent ✓, fabric softener ✓</p>
<p>Outdoor *</p> <p>Membrane-coated weatherproof or outdoor clothing and water-resistant fabrics</p> <p>Notes</p> <ul style="list-style-type: none"> ■ Use special detergent suitable for machine-washing; add the correct dosage to compartment II in accordance with the manufacturer's instructions. ■ Laundry must not be treated with fabric softener. ■ Before washing, clean the detergent drawer thoroughly (manual compartment) to remove fabric-softener residue. 	<p>Max. 2 kg</p> <p> -40 °C</p> <p>0-800** rpm</p> <p>      </p> <p>Detergent -, fabric softener -</p>
<p>Night Wash *</p> <p>Especially quiet programme for washing during the night; suitable for cotton, linen, synthetic and blended fabrics</p> <p>Notes</p> <ul style="list-style-type: none"> ■ End signal deactivated, ■ reduced final spin speed set by default and shorter washing time 	<p>Max. 4 kg</p> <p> -40 °C</p> <p>0-1600** rpm</p> <p>      </p> <p></p> <p>Detergent ✓, fabric softener ✓</p>
<p>* The programmes and additional programme settings are model-dependent. The programmes/settings that are available can either be selected directly in the control panel or under ... Others Programmes or Options .</p> <p>** Max. The maximum spin speed depends on the model and programme</p> <p>*** Reduced load for the speedPerfect  setting</p>	

Programme/type of laundry/instructions	Settings
<p>Shirts / Blouses</p> <p>Non-iron shirts or blouses made of cotton, linen, synthetic fibres or blended fabrics</p> <p>Notes</p> <ul style="list-style-type: none"> Shirts/blouses are only given a short spin on the Less ironing () setting. Hang them up to dry while still dripping wet. -> Self-smoothing effect Use the Delicates / Silk programme to wash shirts/blouses made of silk or delicate fabrics. 	<p>Max. 2 kg</p> <p> - 60 °C</p> <p>0-800** rpm</p> <p>, , , , , , </p> <p>Detergent ✓, fabric softener ✓</p>
<p>Down *</p> <p>Machine-washable fabrics stuffed with down, such as pillows and duvets; also suitable for items stuffed with synthetic fibres</p> <p>Note: . Wash large items separately. Use a detergent designed for delicates and follow the instructions on the item's care label. Use detergent sparingly.</p>	<p>Max. 2 kg</p> <p> - 60 °C</p> <p>0-1200** rpm</p> <p>, , , </p> <p>Detergent -, fabric softener -</p>
<p>Curtain *</p> <p>3.5 kg heavy curtains or 25-30 m² lightweight drapes</p> <p>Notes</p> <ul style="list-style-type: none"> Shorter rinse and final spin cycles. Use a detergent that is suitable for machine-washing curtains. The Prewash () button is set by default. If you do not require a pre-wash cycle, press the button to deactivate the function. 	<p>Max. 3.5 kg</p> <p> - 40 °C</p> <p>0-800** rpm</p> <p>, , , , , , </p> <p>Detergent ✓, fabric softener ✓</p>
<p>Drum clean</p> <p>Programme for cleaning and caring for the drum and the outer tub, e.g. before running the first wash cycle, if washing frequently at a low temperature (40 °C or lower) or if an odour has developed after a prolonged period of non-use. The Drum clean indicator lamp flashes when you use have not used a programme of 60 °C or higher for a long time.</p> <p>Notes</p> <ul style="list-style-type: none"> Run the drum-care programme without any laundry. Use washing powder or a detergent that contains bleach. To prevent foaming, only use half the amount of detergent recommended by the detergent manufacturer. Do not use detergents that are intended for woollens or delicates. 	<p>0 kg</p> <p>80, 90 °C</p> <p>1200 rpm</p> <p></p> <p>Detergent -, fabric softener -</p>
<p>* The programmes and additional programme settings are model-dependent. The programmes/settings that are available can either be selected directly in the control panel or under ... Others Programmes or Options .</p> <p>** Max. The maximum spin speed depends on the model and programme</p> <p>*** Reduced load for the speedPerfect  setting</p>	

Programme/type of laundry/instructions	Settings
Rinse *	-
Rinse Plus with spin	-
	0-1600** rpm
	 ,  ,  , 
	Detergent -, fabric softener ✓
Spin *	-
Extra spin with selectable speed	-
	0-1600** rpm
	
	Detergent -, fabric softener -
Drain *	-
For the rinsing water, e.g. after the  setting (Rinse Hold = no final spin cycle)	-
	-
	-
	-
	Detergent -, fabric softener -
Textile Guard *	Max. 1 kg
Wash cycle followed by waterproofing of membrane-coated weatherproof and outdoor clothing or water-resistant items	 40 °C
	0-800** rpm
	 ,  ,  ,  ,  ,  , 
	Detergent -, fabric softener -
<ol style="list-style-type: none"> Select a programme. Add special detergent for outdoor clothing to compartment  . Press the  button. The programme stops before the last rinse cycle. Follow the information on the display panel. Add a waterproofing agent (max. 170 ml) to compartment  . Press the  button. After-treat the laundry in accordance with the manufacturer's instructions. 	
Notes	
<ul style="list-style-type: none"> Use a special detergent suitable for machine washing and dose in accordance with the manufacturer's instructions: Laundry must not be treated with fabric softener. Before washing, clean the detergent drawer thoroughly (manual compartment) to remove fabric-softener residue. 	
* The programmes and additional programme settings are model-dependent. The programmes/settings that are available can either be selected directly in the control panel or under ... Others Programmes or Options  .	
** Max. The maximum spin speed depends on the model and programme	
*** Reduced load for the speedPerfect  setting	

Programme/type of laundry/instructions	Settings
Sportswear * Sportswear and leisurewear made from microfibre fabrics Notes <ul style="list-style-type: none"> ■ Laundry must not be treated with fabric softener. ■ Before washing, clean the detergent drawer thoroughly (manual compartment) to remove fabric-softener residue. 	Max. 2 kg 40 °C 0-800** rpm Detergent -, fabric softener -
Auto * Hard-wearing fabrics; The degree of soiling and the type of fabric are automatically detected, and the washing sequence and intelligent dosing are adjusted accordingly.	Max. 6 kg 40 °C 1400** rpm Detergent ✓, fabric softener ✓
Auto soft * Gentler treatment of the laundry; The degree of soiling and the type of fabric are automatically detected, and the washing sequence and intelligent dosing are adjusted accordingly.	Max. 3.5 kg 30 °C 1000** rpm Detergent ✓, fabric softener ✓
Auto Intensive * More intensive treatment of the laundry; The degree of soiling and the type of fabric are automatically detected, and the washing sequence and intelligent dosing are adjusted accordingly.	Max. 6 kg 60 °C 1400** rpm Detergent ✓, fabric softener ✓
* The programmes and additional programme settings are model-dependent. The programmes/settings that are available can either be selected directly in the control panel or under ... Others Programmes or Options .	
** Max. The maximum spin speed depends on the model and programme	
*** Reduced load for the speedPerfect setting	

Starching

Note: Laundry should not be treated with fabric softener.

1. Switch on the appliance.
2. Select the **Rinse** programme.
3. Pour liquid starch into compartment in accordance with the manufacturer's instructions (clean first if necessary).
4. Press the ►|| button.

Dyeing/bleaching

Dye should only be used in normal household quantities. Salt may damage stainless steel. Always follow the dye manufacturer's instructions.

Do **not** use the washing machine to bleach clothes.

P+ Programme default settings

The programme default settings are displayed in the main menu after selecting the programme.

Display panel → *Page 28*

You can change the default settings:

- Temperature, Spin speed and Finished in as long as the arrow is displayed in the main menu and/or
- the i-Dos settings, → *Page 39*

An overview of all programme settings, which can be selected depending on the programme, can be found from → *Page 32*.

Temperature

Depending on what stage the programme is in, you can change the set temperature before and during the programme.

The maximum temperature that can be set depends on the programme that has been selected.

Spin speed

(Spin)

Depending on what stage the programme is in, you can change the spin speed (in rpm; revolutions per minute) before and during the programme.

The maximum speed that can be set depends on the model and programme that has been selected.

Setting 0: No spin cycles, the water is only drained. The laundry stays wet inside the drum, e.g. for items that should not be spun.

Finished in

The programme duration is shown after selecting the programme.

Before starting the programme, you can preselect the programme end in hourly increments (h = hour) up to a maximum of 24 hours.

After starting the programme, the selected number of hours **e.g. 8 h** is shown on the display panel and counts down until the wash programme starts. The duration of the programme is then displayed.

Note: The programme duration is automatically adjusted when the programme is running. Changes to the programme default settings or programme settings, options, foam detection function, unbalanced load detection, the load or soiling may also change the programme duration.

After starting the programme, you can change the preselected number of hours as follows:

1. Press the ►|| button.
2. Use the **Finished in** button to change the number of hours.
3. Press the ►|| button.

After starting the programme, while the programme is running, you can add or remove laundry if necessary.
→ *Page 46*

i-Dos settings





Your washing machine has an intelligent dosing system for liquid detergent and fabric softener (or detergent when using the setting **Dispenser content:**

Detergent → *Page 57*)

For the majority of programmes on your washing machine, detergent and fabric softener are dosed automatically.





The i-Dos settings are not retained when the appliance is switched off.

The following have been preset at the factory:

- i-Dos  : 
Detergent dosage for lightly soiled laundry
- i-Dos   : 
Fabric softener dosage for a medium level of softness

i-Dos for detergent





Dosage strengths

-  High: heavy soiling and staining
-  Medium: average soiling
-  Low: light soiling
-  Automatic dosage deselected, manual dosage → *Page 51*

You can change the settings for automatic detergent dosage before the programme starts. You can find information on degrees of soiling on → *Page 31*

i-Dos for fabric softener

Dosage strengths

-  High: high level of softness
-  Medium: medium level of softness
-  Low: low level of softness
-  Automatic dosage deselected

Depending on what stage the programme is in, you can change the settings for automatic detergent dosage.

P+ Additional programme settings/options (* depending on the model)

The settings/options that are available depend on the model.

Depending on the programme selected, you can select different settings/options in order to better adapt the washing process to your items of laundry.

The settings can be selected:

- via the corresponding button on the control panel or
- via the Options  button.
→ Page 26

An overview of all additional settings, which can be selected depending on the programme, can be found from
→ Page 32.

speedPerfect

Washing in a shorter time while achieving a washing result that is consistent with, but uses more energy than, the selected programme, without the speedPerfect  setting.

Note: Do not exceed the maximum load.

Overview of programmes → Page 32

ecoPerfect

Energy-optimised washing by reducing the temperature while achieving a washing result that is consistent with the selected programme, without the ecoPerfect  setting.

Prewash *



()

Settings that can be selected:

on – off

For heavily soiled laundry.



Notes

- If **intelligent dosage is selected**, the detergent will be dispensed automatically for the prewash and the main wash.
- Set the i-Dos dosage to **medium** to prevent overdosing.
- If **dosing manually**, allocate detergent to the prewash and the main wash. Place detergent for the prewash in the drum and add detergent for the main wash to compartment  .

Extra rinse *

()

Settings that can be selected:

-  **+ 1 rinse cycle**
-  **+ 2 rinse cycles**
-  **+ 3 rinse cycles**

Off

Additional rinse cycles for particularly sensitive skin and/or for areas with very soft water.

Longer program duration.

The number of rinse cycles that the appliance actually runs depends on the number that is set as a basic setting for the program in question.

Water Plus *

()

Settings that can be selected:

on – off

Increased water level, gentler treatment of the laundry.

Less ironing *



Settings that can be selected:

on – off

Reduces creasing thanks to a special spin sequence followed by fluffing and reduced spin speed.

Note: The washing's residual moisture is increased.

Soak *





Settings that can be selected:



on – off

Before the main wash cycle starts, the washing remains for longer in the water to partially dissolve intensive soiling.

To be used for particularly stubborn soiling.

Dose the detergent using i-Dos or add it into the   compartment in accordance with the manufacturer's instructions.

Notes

- Load laundry of the same colour.
- If your machine does not have this option, you can soak as follows:
 1. Select i-Dos or dose detergent in the   manual compartment in accordance with the manufacturer's instructions.
 2. Select the **Cotton 30 °C** programme and the ►|| button.
 3. Press the ►|| button after approx. 10 minutes. The laundry remains in the soaking solution.
 4. Leave the laundry to soak for as long as required, then either press the ►|| button again to continue the programme or change the programme.

Note: No additional detergent is required; the soaking solution is used for washing.

Rinse Hold *



Settings that can be selected:

on – off

The washing remains in the water after the last rinse cycle. End the programme → *Page 46*

Silent Wash *



Settings that can be selected:

on – off

Reduced noise values thanks to special wash and spin cycle and deactivated end signal. Especially suitable for washing at night.

Note: Residual moisture of the washing is slightly increased.

Stains *



In total, there are 16 different types of stain to choose from.

Types of stain that can be selected:

	Baby food
	Blood
	Egg
	Strawberry
	Soil + sand
	Grass
	Coffee
	Cosmetics
	Orange
	Red wine
	Chocolate
	Sweat
	Dirty socks
	Grease + oil
	Tea
	Tomatoes

off

Do not let stains dry. Remove solid substances beforehand.

Select a programme with a stain type:

1. Arrange items of washing as usual.
2. Select a programme.
3. Load the washing machine
4. Select a stain type (depending on the selected programme).
5. Start the programme.

The washing machine adjusts the average washing temperature, drum movement and soaking time to the specific type of stain. Hot or cold water, gentle or intensive washing and long or short soaking ensure that the wash-programme sequence is specially adapted to each type of stain. This makes sure that stains are treated in the best possible way.

The treatment of two stains explained in the following example:

Blood

Blood is first “dissolved” in cold water, then the selected wash programme starts.

Egg

Egg particles are removed by soaking in the lukewarm water bath, selecting a wash cycle with a high water level and running additional rinse cycles.

Following intensive research, we have developed comparable solutions for other stains.



Operating the appliance

Preparing the washing machine

Note: The washing machine **must be correctly installed** and **connected**.

From → *Page 14*

1. Plug into the mains.
2. Turn on the tap.
3. Open the washing machine door.
4. Check that the drum is completely drained. Drain if necessary. Otherwise, the load display may malfunction. → *Page 58*

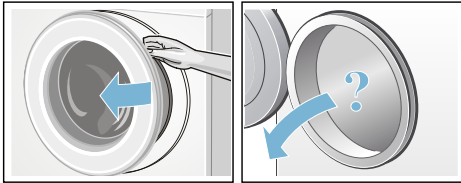

Switching on the appliance/ selecting a programme

Press the **I** button. The appliance is switched on.

The Siemens logo appears on the display and all indicator lamps light up.

The **Cotton** programme set at the factory is then always displayed.

You can:

- use this programme **or**
- select another programme on the control panel **or**
- select a programme under **... Others**. → *Page 28*

Note: If you have activated the childproof lock, you must deactivate it before you can set a programme.

The indicator lamp on the programme selector lights up and the main menu with the **programme default settings** for the selected programme appear on the display panel:

- Temperature,
- Spin speed,
- Programme duration,
- i-Dos settings,
- Any additional settings and
- Information on water and energy consumption. → *Page 13*

In appliances with a **drum light**:

The drum is lit after switching on the appliance, after opening and closing the door and after starting the programme. The light switches off automatically.

You can:

- use the programme default settings and load laundry → *Page 44*,
- or change the programme default settings and/or select additional settings.

Change the programme default settings

You can use or change the default settings for each washing cycle.

To do this, repeatedly press the corresponding button until the required setting is displayed. → *Page 32*

Note: Pressing and holding the buttons automatically runs through the set values.

The settings are activated without needing to be confirmed.



After the appliance is switched off, the i-Dos settings for **☼ I** **☼** and **☼** are retained. All other settings are not saved and must be selected again.

Programme default settings
→ *Page 32*

Select additional programme settings

By selecting additional settings/options, you can better adapt the washing process to your items of laundry.

The settings can be selected or deselected depending on the progress of the programme. → *Page 28*

The ecoPerfect  and speedPerfect  button indicator lamps light up if a setting is activated.

The other settings are indicated by a symbol on the display panel if the setting is activated.

For multi-level settings, press and hold the buttons to run through the settings automatically.

The settings are not saved after the washing machine is switched off.

Additional programme settings/options → *Page 40*

Placing laundry into the drum

Warning **Risk of death!**

Items of laundry pretreated with cleaning agents that contain solvents, e.g. stain remover/cleaning solvent, may cause an explosion after being loaded into the washing machine.

Hand-rinse these items of laundry thoroughly beforehand.

Load the pre-sorted, unfolded laundry into the drum. The load screen for the selected programme (e.g. **Easy-Care**) is indicated on the display panel.

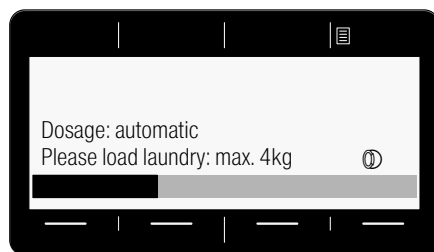



The load bar fills as the laundry is loaded. If the maximum load is exceeded, the bar flashes. Observe the maximum indicated load. Overfilling adversely affects the washing result and encourages creasing.



Notes

- Mix items of laundry of varying sizes. Laundry items of different sizes distribute themselves better during the spin cycle. Individual laundry items may cause an unbalanced load.
- Wait until the Siemens logo no longer appears before adding laundry.
- The load screen appears when the door is opened or when the amount of laundry is changed.

Measure and add detergent and care products

For the majority of programmes on your washing machine, detergent and fabric softener are dosed automatically; it is a factory setting for these programmes and can be changed. → *Page 32*

In addition to intelligent dosing, you can manually add cleaning aids (e.g. softener, bleach or stain remover) to compartment  , if necessary. → *Page 51*

For programmes without intelligent dosing, or as desired (in which case, set intelligent dosing to  (off)), detergent can be added manually to compartment  . → *Page 51*

Start the programme

Make sure that no items of laundry are trapped between the door and the rubber seal, and close the door.

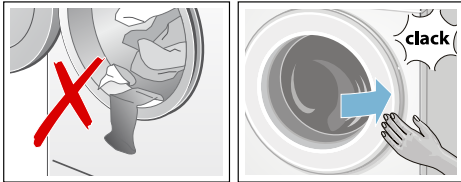

The main menu for the selected programme is indicated again on the display panel.

Press the ►|| button to start the programme.

During washing, the progress of the programme is displayed in a bar on the display panel. The bar fills in during the washing cycle and provides information about the current progress of the programme.

The arrows fade in and out according to the progress of the programme. They indicate the programme settings/options which can be changed/added as the programme progresses.

Some programme sequence steps explained:

- **Load adjust active** → Page 58

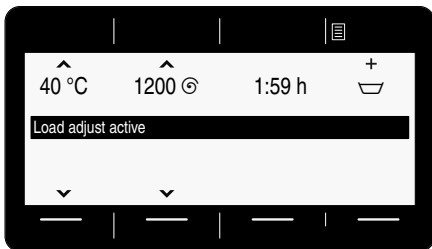

- **Pre-washing, Washing, Rinsing, Spin, Drain ...** are displayed during the wash cycle.
- **Extra rinse: foam**

Note: Foam detection

If **Foam has been detected** also appears on the display panel, the washing machine has detected too much foam during the wash programme and has automatically switched on one or more rinse cycles in order to remove the foam. Add less detergent to the next washing cycle with the same load.

- Other displays → Page 64

If you want to lock the programme to prevent it from being inadvertently adjusted, you can select the childproof lock as follows.

Child lock 3 sec.

You can lock the washing machine to prevent the functions you have set from being changed inadvertently.

To **activate**/deactivate, press and hold both buttons **Child lock 3 sec.** for approx. three seconds. → Page 26
 ☞ **Childproof lock activated** appears in the display panel.

After approx. three seconds, the display reverts back to the main menu.

If you adjust the programme selector or select a button when the childproof lock is activated, ☞ **Childproof lock activated** appears in the display panel.

Notes

- The childproof lock can be activated regardless of the appliance's status.
- The childproof lock remains active, even once the washing machine has been switched off. Before selecting the next programme, deactivate the childproof lock.
- If the appliance is switched off while the programme is running and childproof lock is activated, the programme continues when the appliance is switched back on.

Adding laundry

After starting the programme, you can add or remove laundry if necessary.

Press the ►|| button to do this.

The ►|| button indicator lamp flashes and the machine checks whether it is possible to add laundry.

It is possible to add laundry when **Pause: Reload is possible** appears on the display.

To continue the programme, press the ►|| button. The programme continues automatically.

Notes

- Do not leave the door open for too long when adding laundry as water from the laundry may leak out.
- For safety reasons, the door remains locked when the water level or temperature is high, or while the drum is turning, and it is not possible to add laundry during this time. Follow the information on the display panel.
- The load display is not active during reloading.

Changing the programme

If you have started the wrong programme by mistake, you can change the programme as follows:

1. Press the ►|| button.
2. Select another programme.
3. Press the ►|| button. The new programme starts from the beginning.

Cancel the programme

For programmes at high temperatures:

1. Press the ►|| button.
2. To cool down laundry: Select **Rinse**.
3. Press the ►|| button.

For programmes at low temperatures:

1. Press the ►|| button.
2. Select **Spin** or **Drain**.
3. Press the ►|| button.

Programme end during rinse hold

The following appears on the display panel:

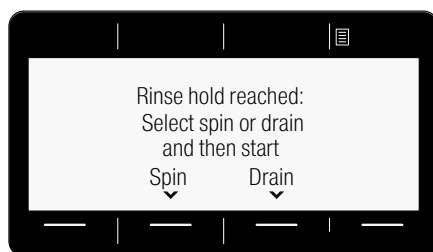

Continue the programme by:

- Select the **Spin** (change the spin speed if necessary) or the **Drain** programme.
- Press the ►|| button.

Programme end

© **Finished, remove washing** appears on the display panel. The ►|| button indicator lamp is off.

Removing laundry/switching off the appliance

1. Open the loading door and remove the laundry. Follow the information on the display panel.
2. Press the ① button. The appliance is switched off.
3. Turn off the tap.
Note: Not required for AquaStop models.

Notes

- Do not leave any items of laundry in the drum. They may shrink in the next wash or discolour another item.
- Remove any foreign objects from the drum and the rubber gasket – risk of rusting.
- Wipe the rubber gasket dry.

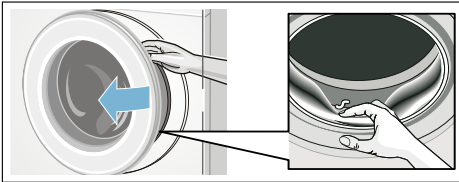

Notes



- Leave the loading door and detergent drawer open so that any residual water can evaporate.
- Always wait until the programme ends, as the appliance could still be locked. Then switch the appliance on and wait for it to unlock.
- If the display panel goes off at the end of a programme, the energy-saving mode is active. Press any button to activate the panel.

i-DOS Intelligent dosing system



Intelligent dosing system in the detergent drawer

i-Dos Intelligent Dosing system

Your washing machine has an intelligent dosing system for liquid detergent and fabric softener.

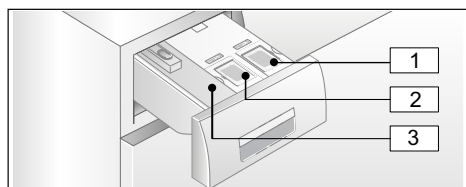
The i-Dos compartments  and  in the detergent drawer are used for this purpose. You can choose whether you would like to use one liquid detergent and one fabric softener or two liquid detergents. Dispenser selection → *Page 57*



- 1 Dispenser  (1.3 l) for liquid detergent
- 2 Dispenser  (0.5 l) for fabric softener (or detergent with dispenser selection)
- 3 Compartment  for manual dosing

Depending on the programme selection and settings, the optimum amounts of detergent/fabric softener are dosed via the i-Dos dispenser.

Initial use/filling the dispensers

Refer to the manufacturer's instructions when choosing your detergent and fabric softener. We recommend the use of standard, universal and colour liquid detergents for all machine-washable, coloured fabrics made of cotton or synthetic materials.

Notes

- Only use easy-pour liquid products that the manufacturer recommends adding to the detergent drawer.
- Do not mix different liquid detergents. If changing your liquid detergent (type, manufacturer, etc.), empty the dispenser completely and clean it. → *Page 60*
- Do not use products containing solvents, caustic agents or volatile substances (e.g. bleach).
- Do not mix detergent and fabric softener.
- Do not use products that have expired or are highly congealed.
- To prevent drying out, do not leave the dispenser lids open for a long period of time.

Filling the dispensers:

The dispensers in the detergent drawer are marked using corresponding dispenser covers:

-  Standard/universal detergent
-  Fabric softener

1. Open the detergent drawer.
2. Open the dispenser cover(s).
3. Add detergent/fabric softener. Do not fill above the **max.** marking.

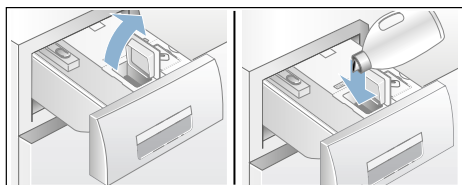

4. Close the cover(s).
5. Slowly push the detergent drawer in completely.

When the appliance is switched on, the following indicates that the detergent drawer is closed completely:

- The corresponding illuminated display on the drawer handle lights up when intelligent dosing i-Dos is selected
- The display flashes once and then goes out if intelligent dosing is not selected.

Everyday use

Illuminated displays on the drawer handle:

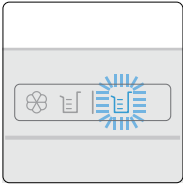

- The display **lights up** if intelligent dosing is selected for the corresponding dispenser:
 - for dispenser (detergent),
 - for the illuminated display for the combined compartment , the lamp for the appropriate dispenser content lights up:
 - for fabric softener/ for detergent. → Page 48
- The display **flashes** if the fill level of the selected intelligent dosing dispenser is below the minimum level.

(De)selecting intelligent dosage and adjusting the dosage strength:

The intelligent dosages for detergent and fabric softener are set at the factory for programmes in which intelligent dosing can be used.

Overview of programmes → Page 32

The dosage strength has been preset to low (lightly soiled laundry) for detergent and to medium (medium level of softness) for fabric softener . It can be changed for each programme. → Page 39

In addition to intelligent dosing, cleaning aids (e.g. stain remover) can be added manually to compartment , if necessary. → Page 51

Note: Depending on the programme, the selection (on/off) as well as the relevant dosage strength that has been selected for i-Dos and i-Dos are saved until they are changed, even when the machine is switched off.

Topping up the detergent/ fabric softener:

If, while intelligent dosing is selected, the respective illuminated display flashes and there is corresponding information on the display panel, this indicates that the minimum fill level has not been reached. The content is sufficient for approx. 3 washes.

The same detergent or fabric softener can be added at any time. If you change the product/manufacturer, we recommend that you clean the dispensers first. → Page 60

If required, adjust the basic dosage.

Base dosage

The basic dosages are:

- **For detergents** – based on the manufacturer's recommendation for average soiling and the respective water hardness.
- **F or fabric softeners** – based on the manufacturer's recommendation for a medium level of softness.

Refer to the packaging label on your detergent/fabric softener or ask the manufacturer directly for this information.

To find out the hardness of your water supply, use a test strip or check with your water supplier.

My water hardness:



Below is an example of detergent dosages on a packaging label:

Degree of soiling → Water hardness ↓	light	normal	heavy	very heavy
soft/medium	55 ml	75 ml	120 ml	160 ml
hard/very hard	75 ml	95 ml	150 ml	180 ml

The default setting for the basic dosage is set specifically according to the area in which you live (e.g. 75 ml for detergent and 36 ml for fabric softener).

Set the basic detergent dosage according to the detergent's packaging label. Take your water hardness into consideration when doing so.

Select the basic fabric softener dosage according to how soft you would like your laundry to be.

Changing one basic dosage affects all three dosage quantities in the same way.

Notes



- Reduce the basic dosage if using a very concentrated detergent.

- If large amounts of foam are repeatedly created during washing, please check your basic dosage and dosage quantity settings. Certain types of liquid detergent can also create excessive amounts of foam. If your basic dosage and dosage quantity settings are correct, we advise you to use a different detergent.





Changing the basic dosages:

Appliance settings → Page 57

Dispenser content for i-Dos

Instead of fabric softener, a second liquid detergent can be used in the i-Dos   dispenser.

Notes



- When switching the i-Dos  dispenser content from **fabric softener to detergent**, the basic dosage for detergent is set to factory settings for this dispenser and the dosage for this detergent is set to **Off** for all programmes in which intelligent dosing can be used. Then use the i-Dos button in the display panel to select the detergent dosage (low, medium or high).
- The i-Dos  dispenser is automatically deactivated if detergent dosing is activated for the i-Dos  dispenser. The settings for this programme are saved until they are changed.
- When switching the i-Dos  dispenser content to **Fabric softener**, the basic dosage is set to factory settings and the dosage is set to "normal" for all programmes in which intelligent dosing can be used.
- Switching the dispenser content requires additional confirmation via the display panel.

Changing the dispenser content:

Appliance settings → *Page 57*

Manual dosage

In addition to intelligent dosing, you can manually add cleaning aids (e.g. softener, bleach or stain remover) to compartment , if necessary.

For programmes without intelligent dosing, or as desired (in which case, set intelligent dosing to ) (off)), detergent can be added manually to compartment .

 Warning**Eye/skin irritation!**

Detergent and care products may spray out if the detergent drawer is opened while the appliance is in operation. Open the drawer carefully.

Rinse eyes or skin thoroughly if they come into contact with detergent/care products.

If swallowed accidentally, seek medical advice.

Caution!**Damage to the appliance**

Cleaning agents and agents for pretreating laundry (e.g. stain removers, prewash sprays, etc.) may cause damage if they come into contact with the surfaces of the washing machine.

Do not allow these agents to come into contact with the surfaces of the washing machine. If necessary, immediately wipe away spray residue and other residues/droplets with a damp cloth.



Notes

- When dosing all detergents, cleaning aids and cleaning agents, always follow the manufacturer's instructions.
- If dosing detergent manually, do not add additional detergent to the intelligent dosing dispenser (set intelligent dosing to ) (off)). This will prevent overdosing and foaming
- Dilute viscous fabric softener and fabric conditioner with water to prevent blockages.

Dosing and adding detergent:

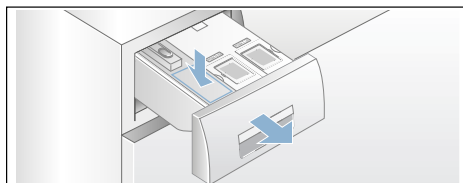
1. Pull out the detergent drawer.



2. Add the correct dosage to compartment   depending on:
 - Soiling
 - Water hardness (ask your water supply company)
 - The amount of laundry
 - The manufacturer's instructions
3. Close the detergent drawer.

Home Connect

This appliance is Wi-Fi-capable and can be remotely controlled using a mobile device.

You can use the Home Connect app to do the following on your appliance from your mobile device:

- Set up programs and launch them.
- Adjust, activate and deactivate program settings.
- Query the status of programs.
- Adjust, activate and deactivate appliance settings.
- Switch off the appliance.

Before you can use the Home Connect functions, you will need to carry out the following steps:

1. Install the Home Connect app on your mobile device.
2. Register in the Home Connect app.
3. Connect your appliance to your home network automatically **or** manually (you only need to do this the first time).
4. Connect your appliance to the Home Connect app.

You can find information about the app on our Home Connect website www.home-connect.com

Home Connect services are not available in every country. The availability of the Home Connect function depends on the availability of Home Connect services in your country. You can find information on this at: www.home-connect.com

Notes

- Please observe the safety precautions in this instruction manual and make sure that these are complied with even when operating the appliance via the Home Connect app while you are away from home. You must also follow the instructions in the Home Connect app.
- You cannot use the Home Connect app to make changes while the controls on the appliance are being operated. However, you can use the Home Connect app to see any adjustments made directly on the appliance itself.

Calling up the Home Connect menu

In the Home Connect menu, you can create and view network connections, reset network settings, activate/deactivate Wi-Fi and find other Home Connect functions.

1. Switch on the appliance.
2. Press and hold **Remote start**  for at least 3 seconds.

Aut. network log-in appears in the display.
You are now in the Home Connect menu.

Note: Briefly press **Remote start**  to exit the Home Connect menu.

Connecting to the home network and the Home Connect app

Connect your appliance to the home network **automatically** or **manually** (you only need to do this the first time).

Notes

- If your home network router has a WPS function, you can connect the appliance to your home network automatically.
- If your home network router does not have a WPS function, you need to connect the appliance to your home network manually.

You must then connect to the Home Connect app.

Note: To connect your appliance to the home network, **Wi-Fi** must be activated on the appliance. **Wi-Fi** is deactivated on the appliance by default and is activated automatically when you connect your appliance to your home network.

Connecting to your home network automatically

Step 2.1

Ensure that you are in the Home Connect menu. → *Page 52*

1. Press **Connect**.

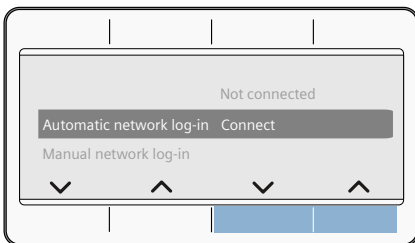

The appliance now attempts to connect to your home network.  flashes in the display.

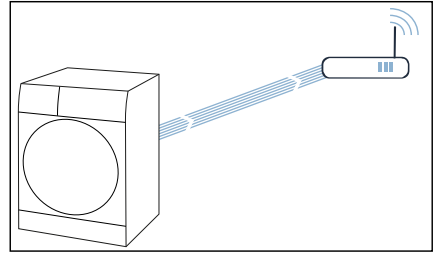

2. Activate the WPS function on your home network router within the next 2 minutes.

If the appliance has connected to your home network successfully, **Connected** ✓ and  appear in the display and light up continuously.

Note: If you are not able to establish a connection, check whether your appliance is within range of your home network. Try connecting automatically again or connect your appliance manually.

Connecting to your home network manually

Step 2.2

Ensure that you are in the Home Connect menu. → *Page 52*

Make sure that you have opened the Home Connect app and are logged in.

1. Press **Man. network log-in**.
2. Press **Connect**.

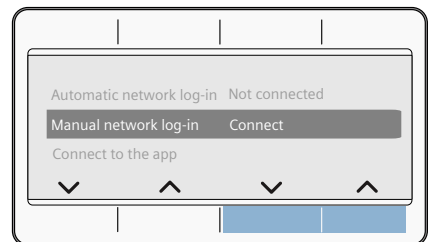

The appliance now sets up its own Wi-Fi network with the name (SSID) **HomeConnect**.

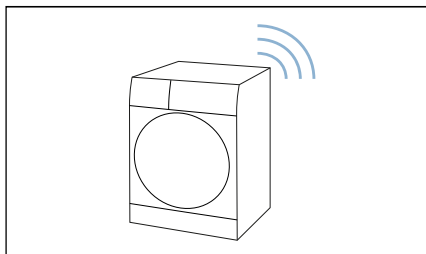

3. Call up the Wi-Fi setting on the mobile device.
4. Connect the mobile device to the **Home Connect** Wi-Fi network and enter the password (key) **HomeConnect**. Your mobile device now connects to the appliance. The connection process may take up to 60 seconds.

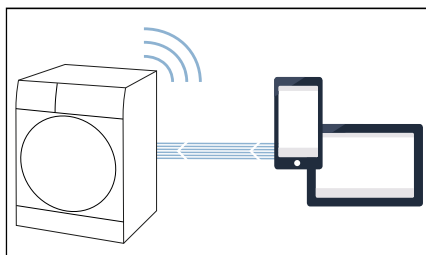

5. Once you have connected successfully, open the Home Connect app on your mobile device and carry out the steps in the app.
6. In the Home Connect app, enter the network name (SSID) and password (key) for **your home network**.
7. Carry out the last steps in the Home Connect app to connect your appliance.

If the appliance has connected to your home network successfully, **Connected** ✓ and  appear in the display and light up continuously.

Note: If you are not able to establish a connection, check whether your appliance is within range of your home network. Try connecting manually again.

Connecting to the Home Connect app

Step 3

If your appliance is connected to your home network, you can connect it to the Home Connect app.

Ensure that you are in the Home Connect menu. → *Page 52*

Make sure that you have opened the Home Connect app and are logged in.

1. Press **Connect to the app**.
2. Press **Connect app**.

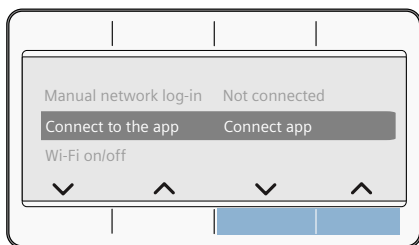

The appliance now attempts to connect to the Home Connect app.

3. Once your appliance is displayed in the app, carry out the last steps in the Home Connect app.

Note: If you were not able to establish a connection, check whether your mobile end device is within range of your home network or is connected to this. Try connecting to the Home Connect app again.

Activating/deactivating Wi-Fi

If your appliance is already connected to your home network, you can activate or deactivate **Wi-Fi** on your appliance.

Ensure that you are in the Home Connect menu. → *Page 52*

1. Press **Wi-Fi on/off**.
2. Press **on** or **off**.

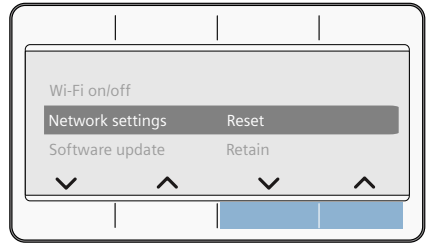
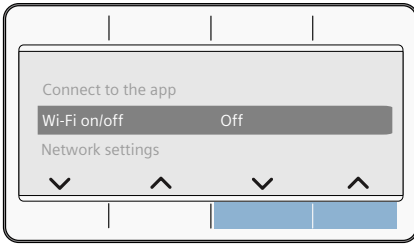

Notes

- If you connect to your home network, Wi-Fi is activated automatically.
- If Wi-Fi is activated, the appliance will not switch itself off automatically.
- If Wi-Fi is switched off on the appliance, it is not possible to use the Home Connect app to start or control the appliance remotely.
- If Wi-Fi is switched off and your appliance was previously connected to your home network, this connection will be re-established automatically when Wi-Fi is switched back on.
- If you activate this function, the energy consumption increases in comparison to the values specified in the consumption value table.

Resetting your network settings

You can reset all of the network settings.

Ensure that you are in the Home Connect menu. → *Page 52*

1. Press **Network settings**.
2. Press **Reset**.

Note: If you want to operate your appliance via the Home Connect app again, you will need to reconnect it to your home network and to the Home Connect app.

Updating the software

You can update the Home Connect software on your appliance. As soon as a new software update is available, a note appears in the display: **Software update**

Install the update directly via the **message in the display** or **manually** as follows:

Ensure that you are in the Home Connect menu. → *Page 52*

1. Press **Software update**.
2. Press **Install**.

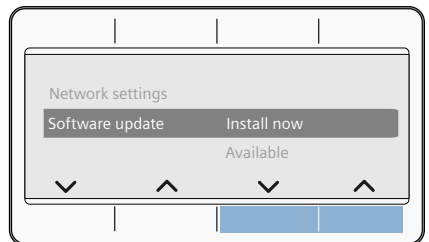

Note: The software update may take several minutes. Do not switch the appliance off while updates are being installed.

Note: If no software update is available, **Not available** appears in the display.

Information on data protection

When your appliance is connected for the first time to a Wi-Fi network, which is connected to the Internet, your appliance transmits the following categories of data to the Home Connect server (initial registration):

- Unique appliance identification (consisting of appliance codes as well as the MAC address of the installed Wi-Fi communication module).
- Security certificate of the Wi-Fi communication module (to ensure a secure data connection).
- The current software and hardware version of your household appliance.
- Status of any previous resetting to factory settings.

This initial registration prepares the Home Connect functions for use and is only required when you want to use these Home Connect functions for the first time.

Note: Ensure that the Home Connect functions can be used only in conjunction with the Home Connect app. Information on data protection can be accessed in the Home Connect app.

Declaration of Conformity

BSH Hausgeräte GmbH hereby declares that the appliance with Home Connect functionality meets the basic requirements and other relevant provisions of the Directive 2014/53/EU.

A detailed RED Declaration of Conformity can be found online at www.siemens-home.bsh-group.com among the additional documents on the product page for your appliance.



2.4 GHz band: max. 100 mW



Appliance settings

You can change the following appliance settings:

Settings that can be selected:

- **End signal**
off – quiet – medium – loud – very loud
Adjust the volume of the end signal.
- **Button signal**
off – quiet – medium – loud – very loud
Adjust the volume of the button signals.
- **Auto power-off of the appliance in 15 – 30 – 60 min – never**
The appliance automatically switches off after ... minutes (= 0 kWh energy consumption); to switch on, press the ① main switch button.
Note: If you have Wi-Fi switched on, the automatic switch-off is set to **Never**.
- **Language**
Deutsch
English
...
Change the displayed language.
- **Info: Drum cleaning on – off**
This instruction reminds you to run a drum cleaning programme.
- **Dispenser content:**
i-Dos ☼☼ Contents
Fabric softener - detergent
Select/change the dispenser content.
- **Basic dosage:**
i-Dos ☼☼ Basic
10 ml – 200 ml
Set the basic dosage in accordance with the recommendations of the detergent/fabric softener manufacturer.

- **Basic dosage:**

i-Dos ☼☼ Basic
10 ml – 200 ml

Set the basic dosage in accordance with the recommendation of the detergent manufacturer.

To change the settings, press and hold both **Basic settings 3 sec.** buttons for approx. three seconds. → *Page 29*

Notes

- The settings are retained after the appliance is switched off.
- If you press and hold the buttons, the settings run through automatically.



Sensors

Automatic load sensing

Depending on the type of fabric and load, the automatic load sensing function optimally adjusts the water consumption and programme duration in each programme.

Unbalanced load detection system

The automatic unbalanced load detection system detects imbalances and ensures even distribution of the laundry by repeatedly starting and stopping drum spinning.

If the laundry is extremely unevenly distributed, the speed is reduced or the spin cycle is not performed for safety reasons.

Note: Place large and small items of laundry evenly in the drum.

→ Page 44, → Page 65

AquaSensor

Depending on the program and model

During a rinse cycle, the Aqua sensor checks the turbidity of the rinsing water (turbidity is caused by dirt and detergent residue). The duration and the number of rinse cycles depend on the turbidity of the water.

Load sensor/display

The load sensor detects the load level in the washing machine when the door is open. This is indicated by the bar filling on the display panel.

Note: In order for the load sensor to fully determine the amount of laundry, the drum must be empty before the washing machine is switched on.

Dosing recommendation

The dosing recommendation indicates a recommended detergent dosage as a percentage, depending on the selected programme and the detected load. The indicated % refers to the dosing recommendation of the detergent manufacturer.

Note: By adhering to the dosing recommendation, you can help look after both the environment and your household budget.



Cleaning and maintenance

Warning

Danger of death!

There is a risk of electric shock if you touch live components. Switch off the appliance and pull out the mains plug.

Warning

Risk of poisoning!

Toxic vapours can be produced by cleaning agents that contain solvents, e.g. cleaning solvent. Do not use cleaning agents that contain solvents.

Caution!

Damage to the appliance

Cleaning agents that contain solvents, e.g. cleaning solvent, can damage surfaces and components in the machine. Do not use cleaning agents that contain solvents.

Prevent detergent residue from building up and odours from forming by following these instructions:

Notes

- Ensure the room in which the washing machine is set up is well ventilated.
- Leave the door and detergent dispenser tray open slightly when the washing machine is not in use.
- Occasionally run a wash using the **Cotton 60 °C** programme and powder detergent.

Machine housing/control panel

- Wipe the housing and the control panel with a soft, damp cloth.
- Remove the detergent residue immediately.
- Do not clean with a water jet.

Drum

Use chlorine-free cleaning agents, do not use steel wool.

If there are odours in the washing machine, or to clean the drum, run the **Drum clean 90 °C** programme without laundry. Add washing powder.

Descaling

Descaling should not be necessary if the detergent is measured out correctly. However, if it is required, follow the manufacturer's instructions for the descaling agent. Suitable descalers can be obtained via our website or from customer services. → *Page 68*

i-Dos detergent draw and its housing

1. Emptying the dispensers:

The dispensers have emptying outlets with removable sealing plugs at the front. To empty the dispensers, first remove the drawer handle as shown below:

a) Pull out the detergent drawer.

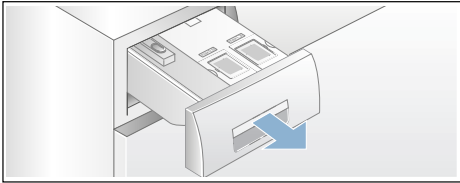

b) Pull the catch (A) on the back of the drawer handle (in the centre at the bottom) slightly towards you. This unlocks the drawer handle (B), which you can then pull off by lifting it upwards.

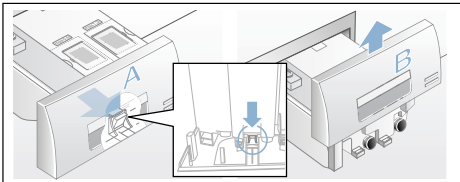

c) To empty the dispensers, carefully pull off each of the sealing plugs and empty the contents into a suitable container.

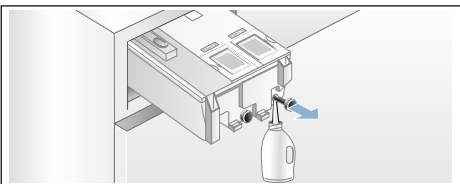

d) Then push the sealing plugs back in completely.

2. Cleaning the dispensers/detergent drawer:

The detergent drawer can be removed completely to allow you to clean to dispensers after you have emptied them.

a) Empty the dispensers before removing the drawer.

Note: Only put the drawer handle back on after you have finished cleaning.

b) Pull out the drawer.

c) Press the catch and remove the drawer completely.

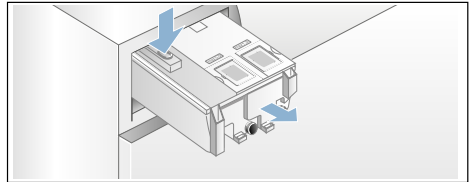

d) Carefully remove the drawer cover.

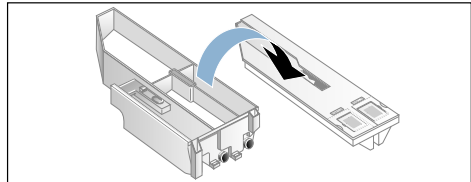

Caution!

Risk of damage to the detergent drawer.

The detergent drawer contains electrical components. These may become damaged if they come into contact with water.

– Do not clean the cover in the dishwasher and do not immerse it in water.

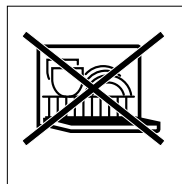

- Protect the rear drawer connector against water, detergent or fabric-softener residue; if necessary, clean the outer surfaces with a soft, damp cloth. Dry before putting back in.
- e) Clean the drawer and the cover with a soft, damp cloth or a hand shower. Also clean the inner surfaces with a soft, damp cloth.

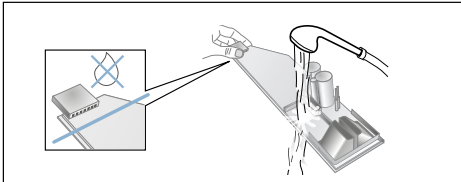

- f) Dry the drawer and the cover and put them back together.
- g) Push the drawer handle back in from above until you feel it click in place.
- h) Clean the inside of the detergent-drawer housing.
- i) Push the detergent drawer in completely.

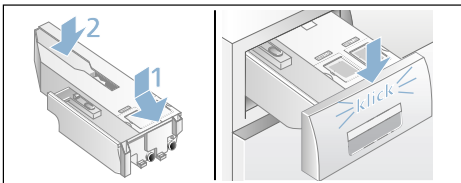

The drain pump is blocked, emergency draining

Warning **Risk of scalding!**

When you wash at high temperatures, the water gets very hot. If you come into contact with the hot water, you may be scalded.

Allow the water to cool down.

1. Turn off the water tap so that no more water can flow in and has to be drained via the drain pump.
2. Switch off the appliance. Pull out the mains plug.
3. Open and remove the service flap.

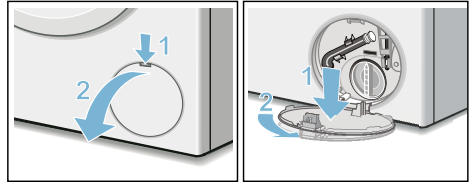

4. Take the drain hose out of the retainer. Remove the sealing cap and pour the water out into a suitable container. Replace the sealing cap and place the drain hose back in the retainer.

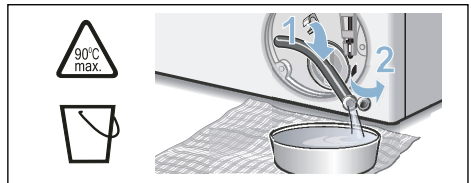

5. Carefully unscrew the pump cover; residual water may leak out. Clean the interior, pump-cover thread and pump housing. The impeller in the drain pump must be able to rotate. Refit the pump cover and screw it on tightly. The handle must be in a vertical position.

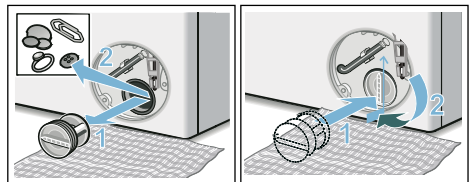

- Put the service flap back on, lock it into place and close it.

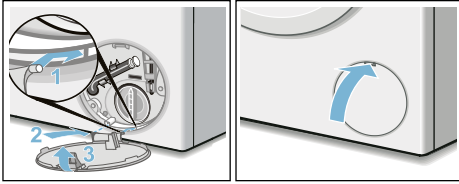

Note: To prevent unused detergent from flowing straight into the drain during the next wash, pour 1 litre of water into compartment  and start the **Drain** programme.

The drain hose at the siphon is blocked

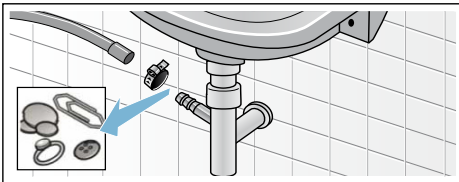

- Switch off the appliance. Pull out the mains plug.
- Loosen the hose clamp. Carefully remove the drain hose; residual water may leak out.
- Clean the drain hose and siphon connecting piece.



- Re-attach the drain hose and secure the connection point using the hose clamp.

Filter in the water supply blocked

First, reduce the water pressure in the supply hose:

- Turn off the tap.
- Select any programme (except Rinse/Spin/Empty).
- Press the  button. Allow the programme to run for approximately 40 seconds.
- Press the  button. The appliance is switched off.
- Pull out the mains plug.

Then clean the filter:

- Disconnect the hose from the tap. Clean the filter with a small brush.

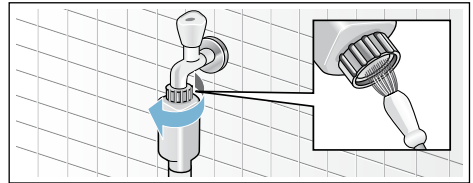

- For standard and Aqua-Secure models, clean the filter on the rear of the appliance: Remove the hose from the rear of the appliance. Use pliers to remove the filter and then clean it.

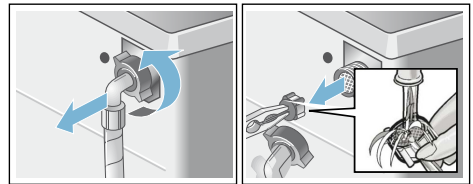

- Connect the hose and check for leaks.

Faults and what to do about them.

Emergency release

E.g. in the event of a power cut

The programme continues when the power supply is restored.

However, if the laundry has to be removed, the washing machine door can be opened as follows:

Warning

Risk of scalding!

When you are washing at high temperatures, there is a risk of scalding if you come into contact with hot water and laundry.

If possible, leave it to cool down first.

Warning

Risk of injury!

You may injure your hands if you reach into the drum while it is turning.

Do not reach into the drum when it is turning.

Wait until the drum has stopped turning.

Caution!

Water damage







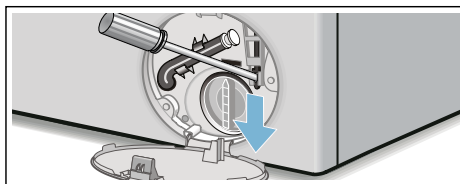

Any escaping water may cause water damage.



Do not open the door if water can be seen through the glass.

1. Switch off the appliance. Pull out the mains plug.
2. Drain the water. → *Page 61*
3. Pull the emergency release downwards with a tool and release. The door can then be opened.







Information on the display panel



Display	Cause/remedy
Top up the i-Dos  ,  container	The i-Dos dispensers are below the minimum fill level; top up → <i>Page 48</i> .
i-Dos  , i-Dos  error; Deactivate i-Dos  , i-Dos 	Set i-Dos  , i-Dos  to Off . Call the after-sales service. The appliance can still be operated using manual dosing. Manual dosing → <i>Page 51</i>
Close the detergent drawer	Push the detergent drawer in correctly. → <i>Page 49</i>
Pause: Reload is not possible	Temperature or water level is too high. Press the ► button to continue the programme.
Door cannot be unlocked: Water level or temperature is too high	Temperature or water level is too high. Press the ► button to continue the programme.
The door cannot be locked; open the door again, then close it and press the ► button	<ul style="list-style-type: none"> ■ Laundry may be caught. Open and close the door again and press the ► button. ■ If necessary, push the door closed or remove some laundry and then push it closed again. ■ If necessary, switch the appliance off and on again; set the programme and make your individual settings; start the programme.
Turn on the tap	<ul style="list-style-type: none"> ■ Turn the tap on fully, ■ Supply hose kinked/trapped, ■ The water pressure is too low. Clean the filter. → <i>Page 62</i>
Clean the drain pump	<ul style="list-style-type: none"> ■ The drain pump is blocked. Clean the drain pump. → <i>Page 61</i> ■ The drain hose/drain pipe is blocked. Clean the drain hose at the siphon. → <i>Page 62</i>
AquaStop has been activated. Call the after-sales service	Not applicable on models without AquaStop There is water in the base trough; the appliance is leaking. Turn off the tap. Call the after-sales service.
Auto power-off in ... seconds,	Appliance automatically switches off after ... seconds if it is not operated for a prolonged period. To cancel, press any button. → <i>Page 57</i>
Water cooling	To protect the wastewater pipes, the hot detergent solution is cooled before being drained.
Drum care information:	This instruction reminds you to run the Drum clean 90 °C programme or a 60 °C programme to clean and care for the drum and the outer tub. Notes <ul style="list-style-type: none"> ■ Run the programme without laundry. ■ Use washing powder or a detergent that contains bleach. To prevent foaming, only use half the amount of detergent recommended by the detergent manufacturer. Do not use detergents that are intended for woollens or delicates. ■ Switch reminder information on/off.

Display	Cause/remedy
	Remote start selected.
	<p>Off: Wi-Fi is switched off and the appliance is not connected to your home network.</p> <p>Flashing: The appliance is trying to connect to your home network.</p> <p>Lit: Wi-Fi is switched on and the appliance is connected to your home network.</p>
Other displays Error E:XXX	Switch off the appliance, wait for five seconds and then switch it on again. If the display appears again, call the after-sales service.

Faults and what to do about them.

Faults	Cause/remedy
Water is leaking from the machine.	<ul style="list-style-type: none"> ■ Attach the drain hose correctly or replace it. ■ Tighten the threaded joint on the supply hose.
The appliance is not filling with water.	<ul style="list-style-type: none"> ■ Have you pressed the ► button? ■ Is the tap turned on? ■ Could the filter be clogged? Clean the filter. ■ Is the supply hose kinked or trapped?
The dispenser is empty and the fill level indicator is not flashing.	<ul style="list-style-type: none"> ■ Is the drawer cover/connector dirty? Cleaning → <i>Page 50</i> ■ Has the detergent drawer been pushed in correctly? Insert correctly. → <i>Page 60</i>
The wrong detergent/fabric softener has been poured into the dispenser(s).	<p>Dispenser(s):</p> <ol style="list-style-type: none"> 1. Empty and clean. 2. Refill. → <i>Page 48</i>
Detergent/fabric softener has congealed in the dispensers.	Clean and refill the dispensers.
The door will not open.	<ul style="list-style-type: none"> ■ The safety function is activated. Stop the programme? → <i>Page 46</i> ■ Is the  childproof lock activated? Deactivate. → <i>Page 45</i> ■ Is  selected (Rinse Stop = no final spin)? → <i>Page 46</i> ■ Can the door only be opened by the emergency release? → <i>Page 63</i>
The programme does not start.	<ul style="list-style-type: none"> ■ Have you pressed the ► or Finished in button? ■ Is the door closed? ■ Is the  childproof lock activated? Deactivate. → <i>Page 45</i>
The drum briefly jerks or judders after the programme has started.	Not a fault – the internal motor test may cause the drum to jerk or judder briefly when the wash programme starts.
The water is not draining.	<ul style="list-style-type: none"> ■ Is  selected (Rinse Stop = no final spin)? → <i>Page 46</i> ■ Clean the drain pump. → <i>Page 61</i> ■ Clean the drain pipe and/or the drain hose.

en Faults and what to do about them.

Faults	Cause/remedy
Water is not visible in the drum.	Not a fault – the water is below the visible area.
The spin result is not satisfactory. Laundry wet/too damp.	<ul style="list-style-type: none"> ■ Not a fault – the unbalanced load detection system has interrupted the spin cycle because the laundry is unevenly distributed. Distribute small and large items of laundry evenly in the drum. ■ Is Less ironing selected (depending on the model)? → <i>Page 49</i> ■ Is the selected speed too low? → <i>Page 41</i>
The appliance restarts the spin cycle several times.	Not a fault – the unbalanced load detection system is adjusting an imbalance.
The programme is taking longer than usual.	<ul style="list-style-type: none"> ■ Not a fault – the unbalanced load detection system is adjusting an imbalance by repeatedly redistributing the laundry. ■ Not a fault – the foam detection system is active – a rinse cycle has been switched on.
The length of the programme changes during the wash cycle.	Not a fault – the programme sequence is optimised for the specific washing process. This may change the length of the programme shown on the display panel.
Residual water in the care-product compartment.	<ul style="list-style-type: none"> ■ Not a fault – the effectiveness of the care product is not affected. ■ Clean the insert if necessary. → <i>Page 44</i>
Odours in the washing machine.	<p>Run the Drum clean 90 °C or Cotton 90 °C programme without laundry. Add standard washing powder or a detergent that contains bleach.</p> <p>Note: . To prevent foaming, only use half the amount of detergent recommended by the detergent manufacturer. Do not use detergents that are intended for woollens or delicates.</p>
Repeated, intensive foaming.	<ul style="list-style-type: none"> ■ Check the basic dosage settings and dosage strength. ■ If required, use a different liquid detergent.
Detergent/fabric softener drips off the seal and collects on the door or in the seal fold.	There is too much detergent/fabric softener in the dispensers. Observe the max markings in the dispensers.
i-Dos  default setting deleted.	All settings are changed when the menu setting i-Dos  : Content is changed. → <i>Page 38</i>
 in the display panel	Wi-Fi is switched on but the connection to the home network could not be established. Check whether your home network is available or reconnect to the home network.
Home Connect is not working.	<ul style="list-style-type: none"> ■ You can find solutions to problems with Home Connect at www.home-connect.com. ■ The availability of the Home Connect functionality depends on the availability of the Home Connect Services in your country. Home Connect Services are not available in every country - for further information please check: www.home-connect.com.

Faults	Cause/remedy
Loud noises, vibrations and machine "wandering" during the spin cycle.	<ul style="list-style-type: none"> ■ Is the appliance level? Level the appliance. → <i>Page 20</i> ■ Are the appliance's feet secured? Secure the appliance's feet. → <i>Page 20</i> ■ Have the transport locks been removed? Remove the transport locks. → <i>Page 16</i>
The display panel/indicator lights do not work while the appliance is running.	<ul style="list-style-type: none"> ■ Has there been a power failure? ■ Have the fuses blown/has the circuit breaker tripped? Switch on the circuit breaker/replace the fuses. ■ If the fault occurs repeatedly, call the after-sales service.
There is detergent residue on the laundry.	<ul style="list-style-type: none"> ■ Some phosphate-free detergents contain water-insoluble residue. ■ Select Rinse or brush the laundry after washing.
In the "Reload" status, ► flashes very quickly and a signal sounds.	<ul style="list-style-type: none"> ■ The water level is too high. It is not possible to add laundry. Close the door immediately, if necessary. ■ Press the ► button to resume the programme.
If you cannot rectify a fault yourself (after switching the machine off and on again) or a repair is required: <ul style="list-style-type: none"> ■ Switch off the appliance and pull the mains plug out of the socket. ■ Turn off the tap and call the after-sales service. 	



After-sales service

If you cannot rectify a fault yourself, contact customer services. → Cover page

We will always find an appropriate solution in order to avoid unnecessary visits by engineers.

Please give customer services the product number (E no.) and the production number (FD) of the appliance.

E-Nr. _____	FD _____
-------------	----------

E no. Product number
FD Production number

You can find this information
*depending on the model:

On the inside of the door*/in the opened service flap* and on the rear of the appliance.

Trust the expertise of the manufacturer.

Contact us for assistance. By doing so, you will ensure that the repairs are carried out by trained service personnel using genuine spare parts.



Consumption rates

Energy and water consumption, programme duration and residual moisture for the main washing programmes

(approximate values)

Programme	Load	Energy consumption*	Water consumption*	Programme duration*
Cotton 20 °C	9 kg	0,25 kWh	90 l	2 ¾ h
Cotton 40 °C	9 kg	1,10 kWh	90 l	3 h
Cotton 60 °C	9 kg	1,16 kWh	90 l	2 ¾ h
Cotton 90 °C	9 kg	2,14 kWh	100 l	2 ¾ h
Easy Care 40 °C	4 kg	0,71 kWh	64 l	2 h
Mixed Fabrics 40 °C	4 kg	0,60 kWh	45 l	1 ¼ h
Delicates / Silk 30 °C	2 kg	0,19 kWh	37 l	¾ h
Wool 30 °C	2 kg	0,19 kWh	41 l	¾ h



Programme	Approximate information on the residual moisture**			
	WM16Y... Max. 1600 rpm	WM14Y... Max. 1400 rpm	WM12Y... Max. 1200 rpm	WM10Y... Max. 1000 rpm
Cotton	44%	48%	53%	62%
Easy-Care	40%	40%	40%	40%
Delicates / Silk	30%	30%	30%	30%
Wool	45%	45%	45%	45%

* Observed values may deviate from the indicated values due to influence of water pressure, hardness and inlet temperature, ambient temperature, type, amount and soiling of laundry, detergent used, fluctuations in power supply and selected additional functions.

** Information on residual moisture based on programme-dependent spin-speed limit and maximum loads.

Efficiency test programmes for cotton fabrics

The following programmes (standard programmes, indicated by ) are suitable for cleaning normally soiled cotton fabrics and are the most efficient with respect to combined energy and water consumption.

Standard programmes for cottons in accordance with Regulation (EU) no. 1015/2010		
Programme + temperature	Load	Approximate programme duration
Cotton Eco  + <60°C	9 kg	4 ¾ h
Cotton Eco  + <60°C	4,5 kg	4 ¾ h
Cotton Eco  + <40°C	4,5 kg	4 ¾ h

Programme setting at maximum speed for testing and energy labelling in accordance with Directive 2010/30/EU with cold water (15 °C).
The stated programme temperature is based on the temperature indicated on the care label in the laundry items. The actual washing temperature may differ from the stated programme temperature for energy-saving reasons; the washing performance corresponds to the selected temperature.

Technical data

Dimensions:

850 x 600 x 590 mm

(height x width x depth)

Weight:

70-85 kg (depending on the model)

Mains connection:

Mains voltage 220-240 V/50 Hz

Nominal current 10 A

Nominal power 1900-2300 W

Water pressure:

100-1000 kPa (1-10 bar)

Power consumption when switched off:

0,12 W

Power consumption when it is left on:

0,43 W

Power consumption when networked (Wi-Fi) in standby mode/duration:

1,5 W / 20 Min.



Aqua-Stop warranty

Only for appliances with Aqua-Stop

In addition to warranty claims against the vendor based on the purchase agreement and to our appliance warranty, we will provide compensation under the following conditions:

1. If water damage is caused due to a fault in our Aqua-Stop system, we will compensate domestic customers for the damage caused.
2. The liability guarantee is valid for the service life of the appliance.
3. It is a prerequisite of all warranty claims that the appliance with Aqua-Stop must have been installed and connected correctly in accordance with our instructions; this also includes a correctly fitted Aqua-Stop extension (genuine accessories). Our warranty does not cover defective feed lines or fittings leading to the Aqua-Stop connection at the tap.
4. Appliances with Aqua-Stop do not need to be supervised during operation, nor secured afterwards by turning off the tap.
The tap only needs to be turned off if you are away from home for a long period, e.g. for several weeks' holiday.

Repair order and advice in the event of faults

GB 0344 892 8999 (Calls charged at local or mobile rate.)

IE 01450 2655 (0.03 € per minute at peak. Off peak 0.0088 € per minute.)

You can find the contact information for all countries in the attached after-sales service directory.

BSH Hausgeräte GmbH

Carl-Wery-Straße 34

81739 München

GERMANY

siemens-home.bsh-group.com

Manufactured by BSH Hausgeräte GmbH under Trademark License of Siemens AG



9001269146 (9805)