











**VG 415 111 / VG 415 111F / VG 415 211**

		<b>G20-20mbar</b>	<b>G25-25mbar G25.3-25mbar</b>	<b>G25-20mbar</b>	<b>G30-29mbar G31-37mbar</b>	<b>G30-50mbar</b>
	w1	170B	170	185A	110A	97
	L	-1 mm	-2 mm	-2 mm	6 mm	-1 mm
	w2	76	76	84	48	44



**VG 415 211 AU**

		<b>Natural Gas 1.0kPa/10mbar</b>	<b>ULPG 2.75kPa/27.5mbar</b>
	w1	195	110A
	L	6 mm	0 mm
	w2	67	42



**VG 415 211 CA**

		<b>NG A 6" WC</b>	<b>Propane 10" WC</b>
	w1	173	110A
	L	2 mm	0 mm
	w2	60	42



**VG 415 211 CN**

		<b>NG 20mbar</b>
	w1	173
	L	3 mm
	w2	60

**VG 415 211 JP**

		<b>LNG 20mbar</b>	<b>LPG 30mbar</b>
	w1	162	103A
	L	3 mm	2 mm
	w2	60	40

**VG 415 311 SG**

		<b>Town Gas 10/12.5/15mbar</b>	<b>LPG 29mbar</b>
	w1	330	103A
	L	2 mm	2 mm
	w2	97	40

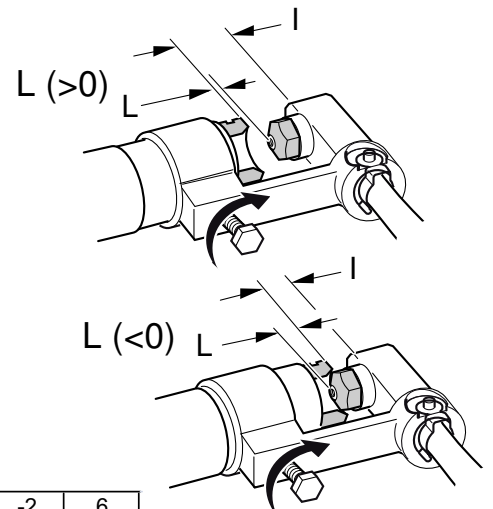
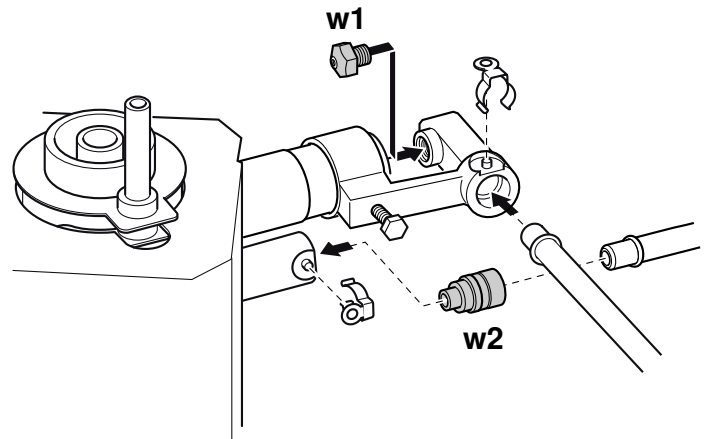
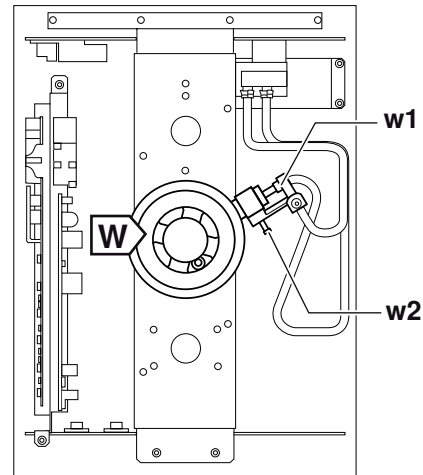

<b>L</b>	-1	-2	6
<b>I</b>	9	8	16

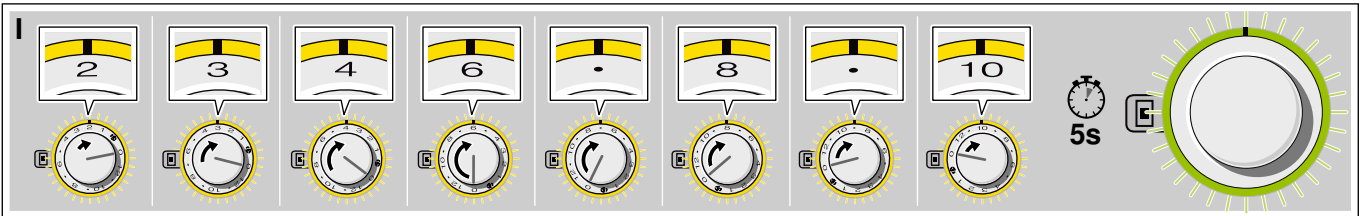
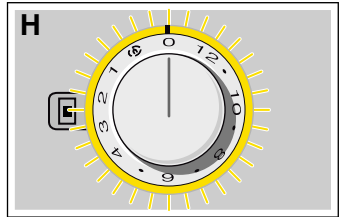
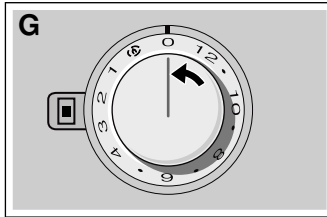
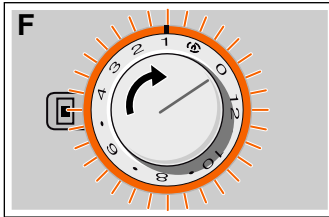
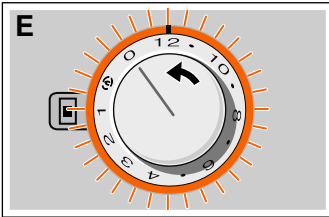
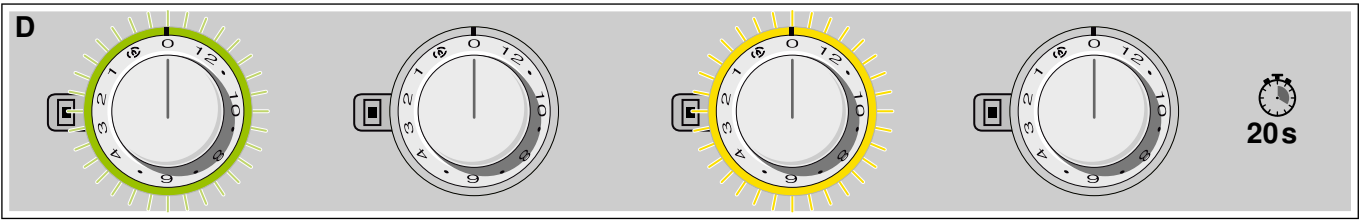
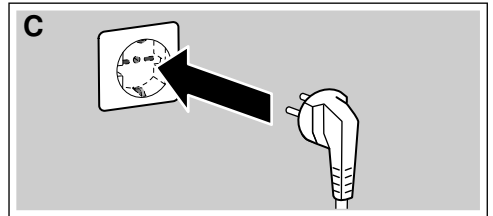
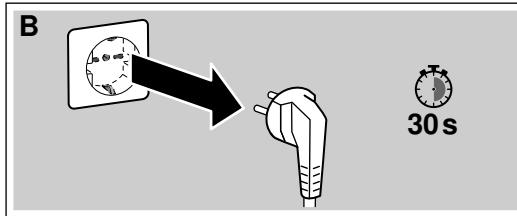
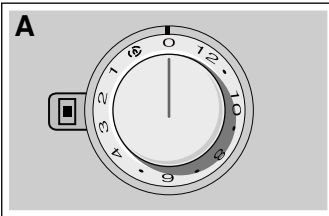

Knob position	2	3	4	6	7	8	9	10
Gas type	G20-20mbar G25-25mbar G25.3-25mbar NG 20mbar LNG 20mbar	G30-29mbar G31-37mbar LPG 29mbar LPG 30mbar	G30-50mbar	G25-20mbar	NG A 6" WC	Natural Gas 1.0kPa/ 10mbar	ULPG 2.75kPa/ 27.5mbar  Propane 10" WC	Town Gas 10/12.5/15mbar

