



VG 491 111 / VG 491 111F / VG 491 211
CG 492 111 / CG 492 111F / CG 492 211

	G20-20mbar	G25-25mbar G25.3-25mbar	G25-20mbar	G30-29mbar G31-37mbar	G30-50mbar
A	a1	98	105	64	57
	L1	0 mm	0 mm	6 mm	6 mm
	a2	40	42	26	22
	L2	4 mm	4 mm	open	4 mm
C	c1	137	155	94	82
	L1	0 mm	0 mm	2 mm	-1 mm
	c2	40	42	26	22
	L2	4 mm	1 mm	open	4 mm
W	w1	170B	185A	110A	97
	L	-1 mm	-2 mm	6 mm	-1 mm
	w2	76	84	48	44

VG 491 211 CA

	NG A 6" WC	Propane 10" WC
A	a1	105
	L1	0 mm
	a2	40
	L2	4 mm
C	c1	150
	L1	0 mm
	c2	40
	L2	4 mm
W	w1	173
	L	2 mm
	w2	60

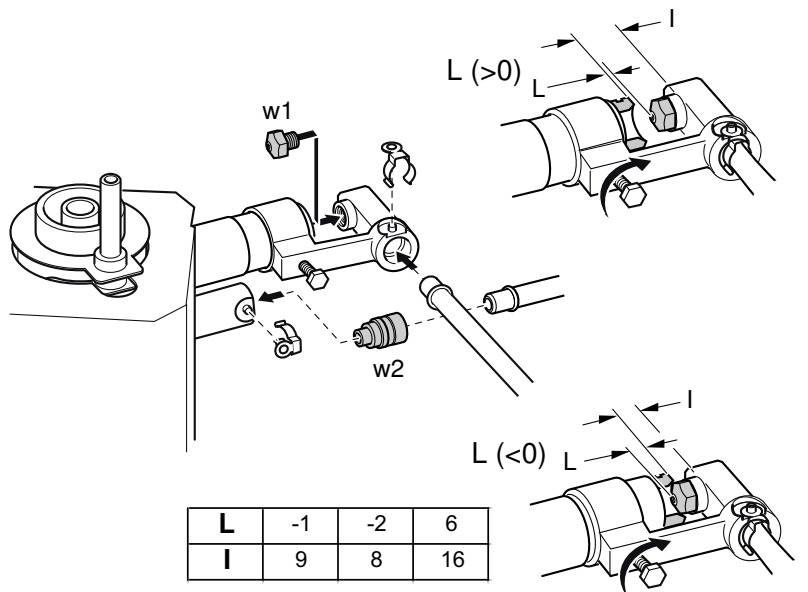
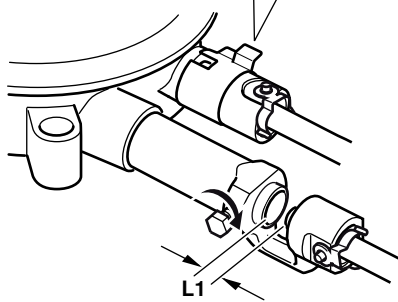
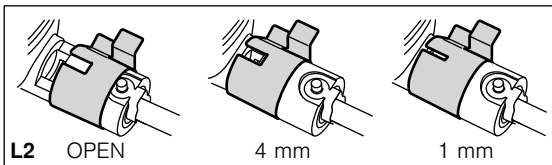
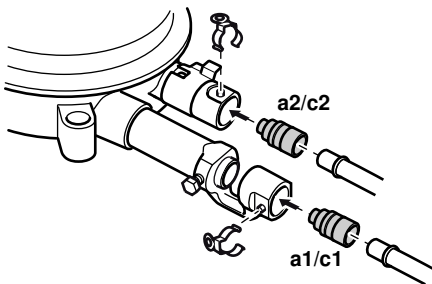
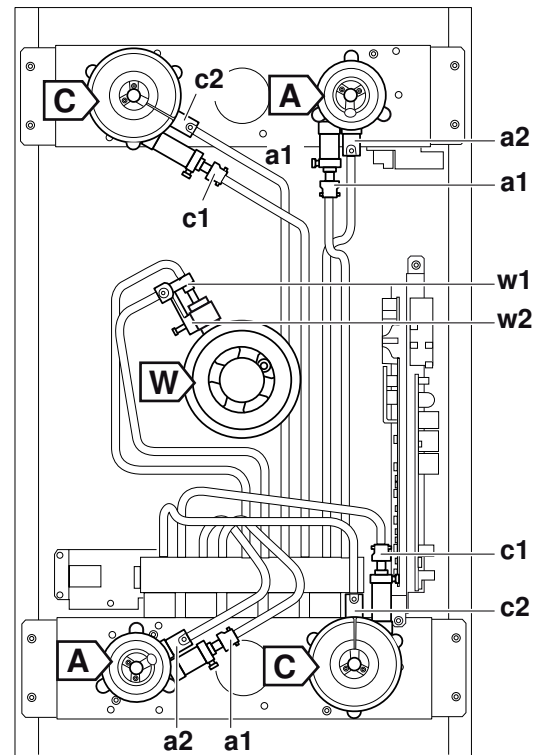

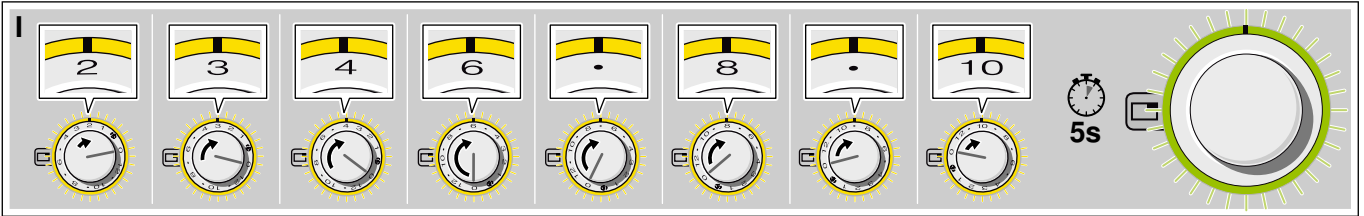
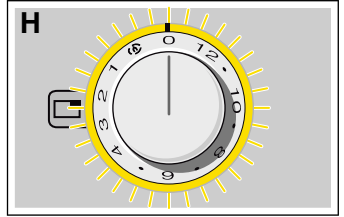
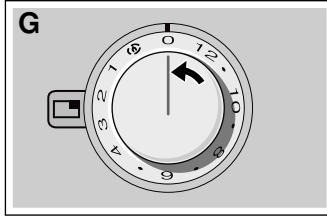
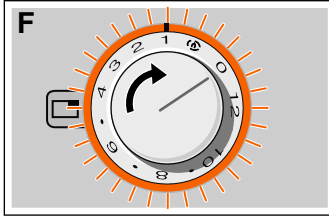
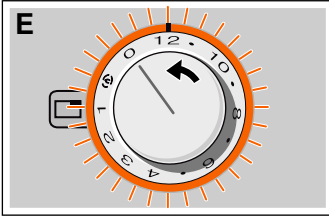
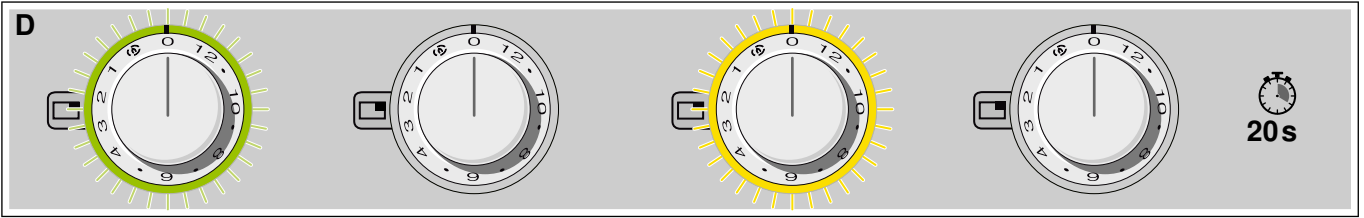
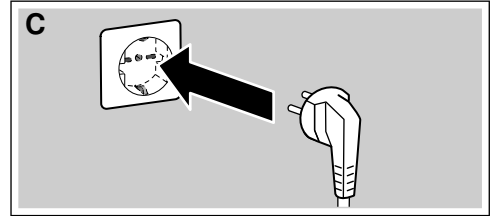
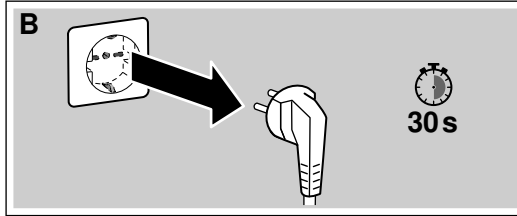
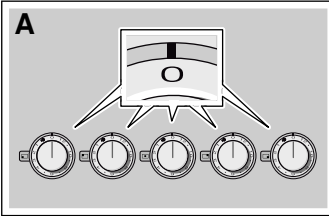

Knob position	2	3	4	6	7	8	9	10
Gas type	G20-20mbar G25-25mbar G25.3-25mbar NG 20mbar LNG 20mbar	G30-29mbar G31-37mbar LPG 29mbar LPG 30mbar	G30-50mbar	G25-20mbar	NG A 6" WC	Natural Gas 1.0kPa/ 10mbar	ULPG 2.75kPa/ 27.5mbar Propane 10" WC	Town Gas 10/12.5mbar

