



SIEMENS



Washing machine

WM4UH... WM4HU...

siemens-home.bsh-group.com/welcome

en Instruction Manual and Installation Instructions

Register
your
product
online

Your new washing machine

You have chosen a Siemens washing machine.

Please take a few minutes to read and become familiar with the advantages of your washing machine.

To meet the high quality demands required by Siemens, every washing machine that leaves our factory is carefully checked to ensure that it functions correctly and is in perfect condition.

For more information on our products, accessories, replacement parts and services, see our website www.siemens-home.bsh-group.com or contact our after-sales service centres.

If the operating and installation instructions describe different models, any differences will be pointed out at the relevant points in the text.



Read these operating and installation instructions before switching on the washing machine.

Display rules

Warning!

This combination of symbol and signal word indicates a possibly dangerous situation. Not heeding the warning can cause death or injuries.

Caution!

This signal word indicates a possibly dangerous situation. Not heeding the caution can cause property and/or environmental damage.

Note/tip

Information about the optimum use of the appliance/any other useful information.





1. 2. 3. / a) b) c)









The steps are represented by numbers or letters.

■ / -

Lists are represented by a small box or a dash.

Contents

 Intended use	5	 Detergent	24
 Safety instructions	5	Correct selection of detergent	24
Children/people/pets	5	Saving energy and detergent	25
Installation	7	 Programme default settings	25
Operation	9	Temperature	25
Cleaning/Maintenance	10	Spin speed	25
 Environmental protection	12	Finish in	26
Packaging/used appliance	12	i-Dos setting	26
Tips on economical use	12	 Additional programme settings	27
 Positioning and connecting	13	Speed	27
Standard accessories	13	Eco	27
Safety instructions	14	Prewash	27
Installation surface	14	Water plus	28
Installation on a base or a wooden joist floor	14	Easy iron	28
Installation on a platform with drawer	14	Soaking	28
Installing the appliance in a kitchenette	15	Rinse plus	28
Removing the transport locks	15	Memory programme	28
Hose and cable lengths	15	Silent wash	28
Water inlet	16	Remote start	29
Water outlet	17	 Operating the appliance	29
Alignment	18	Preparing the appliance	29
Electrical connection	18	Switching on the appliance/ selecting a programme	30
Before washing for the first time	19	Selecting additional programmes	30
Transportation	19	Changing the programme default settings	30
 Getting to know the appliance	20	Selecting the additional programme settings	30
Appliance	20	Placing laundry into the drum	31
Control panel	21	Measuring and adding detergent and care products	31
Touch-Display	22	Starting the programme	31
 Laundry	23	Childproof lock	32
Preparing the laundry	23	Adding/removing laundry	32
Sorting laundry	23	Changing the programme	32
Starching	24	Cancel the programme	33
Dyeing/bleaching	24	Programme end during rinse hold	33
		Programme end	33
		Removing laundry/switching off the appliance	33

 Intelligent dosing system	34	 After-sales service	53
Intelligent dosing system in the detergent drawer	34	 Technical data	54
Initial use/filling the dispensers	34	 Aqua-Stop warranty	55
Everyday use	35		
Basic settings	35		
Manual dosage	36		
 Home Connect	37		
Calling up the Home Connect menu	38		
Connecting to the home network and the Home Connect app	38		
Activating/deactivating Wi-Fi	40		
Resetting your network settings.	40		
Updating the software	41		
Energy management	41		
Information on data protection.	42		
Declaration of Conformity	43		
 Appliance settings	43		
Automatic switch-off.	43		
Basic settings	43		
 Sensors	44		
Unbalanced load detection system	44		
Aqua-Sensors	44		
 Cleaning and maintenance	45		
Appliance housing/control panel	45		
Drum	45		
Descaling.	45		
i-Dos detergent draw and its housing	45		
Drain pump is blocked	47		
The drain hose at the siphon is blocked	47		
Filter in the water supply is blocked	48		
 Faults and what to do about them	48		
Emergency release	48		
Information on the Touch-Display	49		
Faults and what to do about them.	50		



Intended use

- This appliance is intended for private domestic use only.
- Do not install or operate this appliance anywhere that is liable to experience frost and/or outdoor conditions. There is a risk that the appliance will be damaged if residual water in it freezes. If hoses freeze up, they may crack/burst.
- This appliance must only be used for washing domestic laundry, consisting of machine-washable items and hand-washable woollens (see label on item). Using the appliance for any other purpose is outside of the scope of its intended application and is forbidden.
- This appliance is suitable for operation with cold mains water and commercially available detergents and care products (must be suitable for use in washing machines).
- This appliance is intended for use up to a maximum height of 4000 metres above sea level.

Before you switch on the appliance:

Check that there is no visible damage to the appliance. Do not operate the appliance if it is damaged. Should you have any problems, please contact your specialist dealer or our customer service.

Read and follow the operating and installation instructions and all other information provided with this appliance.

Retain the documents for subsequent use or for subsequent owners.



Safety instructions

The following safety information and warnings are provided to protect you from injury and to prevent material damage to your surroundings.

It is nevertheless important to take the necessary precautions and to proceed with care when installing, maintaining, cleaning and operating the appliance.

Children/people/pets



Warning Risk of death!

Children and other people who are unable to assess the risks involved when using the appliance may injure themselves or may find themselves in life-threatening situations. Therefore please note:

- The appliance may be used by children over the age of 8 years and by persons with reduced physical, sensory or mental capacity or by persons with a lack of experience or knowledge as long as they are supervised or have received instruction on how to use the appliance safely and they have understood the potential risks of using the appliance.
- Children must not play with this appliance.

- Do not allow children to clean or maintain this appliance unsupervised.
- Keep children under 3 years and pets away from this appliance.
- Do not leave the appliance unattended when children or other people who are unable to assess the risks are in the vicinity.

 **Warning**
Risk of death!

Children may lock themselves inside appliances and find themselves in a life-threatening situation.

- Do not position the appliance behind a door, as this may obstruct the appliance door or prevent it from opening completely.
- Once an appliance has reached the end of its life, pull the mains plug from the socket **before** severing the mains cable, and then destroy the lock on the appliance door.

 **Warning**
Risk of suffocation!

If allowed to play with the packaging/plastic film or packing components, children may become caught in these or pull them over their heads and suffocate.

Keep packaging, plastic film and packing components away from children.

 **Warning**
Risk of poisoning!

Detergents and care products may result in poisoning if consumed. If accidentally swallowed, seek medical advice. Keep detergents and care products out of the reach of children.

 **Warning**
Risk of burns!

When washing at high temperatures, the glass in the appliance door becomes hot. Stop children from touching the appliance door when it is hot.

 **Warning**
Eye/skin irritation!

Contact with detergents or care products may cause eye/skin irritation. Rinse eyes/skin thoroughly if they/it come(s) into contact with detergents or care products. Keep detergents and care products out of the reach of children.

Installation

Warning

Risk of electric shock/fire/ material damage/damage to the appliance!

If the appliance is not installed properly, this may lead to a dangerous situation. Ensure the following:

- The mains voltage on your power socket must match the rated voltage specified on the appliance (identification plate). The connected loads and the required fuse protection are specified on the identification plate.
- The appliance must only be connected to alternating voltage via a protective contact socket that has been correctly installed. This plug socket must be freely accessible at all times.
- The mains plug and the protective contact socket must match and the earthing system must be correctly installed.
- The installation must have an adequate cross section.
- The mains plug must be freely accessible at all times. If this is not possible, in order to comply with the relevant safety regulations, a switch (2-pole switch-off) must be built into the permanent installation in accordance with electrical installation regulations.

- If using a residual current circuit breaker, only use one that bears the following mark: . The presence of this mark is the only way to be sure that it fulfils all the applicable regulations.

Warning

Risk of electric shock/fire/ material damage/damage to the appliance!

If the appliance's mains cable is altered or damaged, this may result in electric shock, short circuiting or fire due to overheating.

The mains cable must not be kinked, crushed or altered, and must not come into contact with any heat sources.

Warning

Risk of fire/material damage/ damage to the appliance!

The use of extension cords or power strips may result in fire due to overheating or short circuiting.

Connect the appliance directly to an earthed socket that has been correctly installed. Do not use extension cords, power strips or multi-way couplers.

 **Warning**

Risk of injury/material damage/damage to the appliance!

- The appliance may vibrate or move when in operation, potentially resulting in injury or material damage. Place the appliance on a clean, even, solid surface and, using a spirit level to guide you, level it with the screw-in feet.
- If you take hold of any of the appliance's protruding parts (e.g. the appliance door) in order to lift or move it, these parts may break off and cause injury. Do not take hold of any of the appliance's protruding parts in order to move the appliance.

 **Warning**

Risk of injury!

- The appliance is very heavy. Lifting it may result in injury. Do not lift the appliance on your own.
- The appliance has sharp edges on which you could cut your hands. Do not take hold of the appliance by its sharp edges. Wear protective gloves to lift it.

- If the hoses and mains cables are not correctly routed, they may constitute a tripping hazard, which may result in injury. Route hoses and cables such that they do not constitute a tripping hazard.

Caution!

Material damage/damage to the appliance

- If the water pressure is too high or too low, the appliance may not be able to operate properly, and it may also result in material damage or damage to the appliance. Make sure that the water pressure in the water supply facility is at least 100 kPa (1 bar), and does not exceed 1000 kPa (10 bar).
- If the water hoses are altered or damaged, this may result in material damage or damage to the appliance. The water hoses must not be kinked, crushed, altered or severed.
- The use of hoses supplied by other brands to connect to the water supply may result in material damage or damage to the appliance. Use the hoses supplied with the appliance or genuine spare part hoses only.

- The appliance is secured for transportation by transport locking devices. If the transport locking devices are not removed before the appliance is operated, this may result in damage to the appliance.
It is important to completely remove all transport locking devices before using the appliance for the first time. Make sure that you retain these transport locking devices separately. It is important to refit the transport locking devices if the appliance is to be transported, in order to prevent the appliance from being damaged in transit.

Operation

Warning **Risk of explosions/fire!**

Laundry that has been pretreated with cleaning agents that contain solvents, e.g. stain remover/cleaning solvent, may cause an explosion in the drum. Rinse the laundry thoroughly with water before washing it in the machine.

Warning **Risk of poisoning!**

Poisonous fumes may be given off by cleaning agents that contain solvents, e.g. cleaning solvent.
Do not use cleaning agents that contain solvents.

Warning **Risk of injury!**

- If you support your weight/sit on the appliance door when it is open, the appliance may tip over, which may result in injury.
Do not support your weight on the appliance door when it is open.
- If you climb onto the appliance, the worktop may break, which may result in injury.
Do not climb onto the appliance.
- If you reach into the drum while it is still rotating, you risk injuring your hands.
Wait until the drum has stopped rotating.

Warning **Risk of scalding!**

When washing at high temperatures, there is a risk of scalding if you come into contact with hot detergent solution (e.g. when draining hot detergent solution into a washbasin).
Do not reach into the hot detergent solution.

Warning

Eye/skin irritation!

Detergent and care products may spray out if the detergent drawer is opened while the appliance is in operation. Rinse eyes/skin thoroughly if they/it come(s) into contact with detergents or care products. If accidentally swallowed, seek medical advice.

Caution!

Material damage/damage to the appliance

- If the amount of laundry in the appliance exceeds its maximum load capacity, it may not be able to operate properly, or this may result in material damage or damage to the appliance.

Do not exceed the maximum load capacity of dry laundry. Make sure you comply with the maximum load capacities specified for each of the programs → Supplementary sheet for the operating and installation instructions.

- If you pour the wrong quantity of detergent or cleaning agent into the appliance, this may result in material damage or damage to the appliance. Use detergents/care products/cleaning agents and softeners in accordance with the manufacturers' instructions.

Cleaning/Maintenance

Warning **Risk of death!**

The appliance is powered by electricity. There is a risk of electric shock if you come into contact with live components. Therefore please note:

- Switch off the appliance. Disconnect the appliance from the power supply (pull out the plug).
- Never take hold of the mains plug with wet hands.
- When removing the mains plug from the socket, always take hold of the plug itself and never the mains cable, otherwise this may damage the mains cable.
- Do not make any technical modifications to the appliance or its features.

- Repairs and any other work on the appliance must only be conducted by our customer service or by an electrician. The same applies for replacing the mains cable (when necessary).
- Spare mains cables can be ordered from our customer service.

⚠ Warning
Risk of poisoning!

Poisonous fumes may be given off by cleaning agents that contain solvents, e.g. cleaning solvent.

Do not use cleaning agents that contain solvents.

⚠ Warning
Risk of electric shock/material damage/damage to the appliance!

If moisture penetrates the appliance, this may cause it to short circuit.

Do not use a pressure washer or steam cleaner to clean your appliance.

⚠ Warning
Risk of injury/material damage/damage to the appliance!

The use of spare parts and accessories supplied by other brands is dangerous and may result in injury, material damage or damage to the appliance. For safety reasons, use genuine spare parts and accessories only.

Caution!
Material damage/damage to the appliance

Cleaning agents and agents for pretreating laundry (e.g. stain removers, prewash sprays, etc.) may cause damage if they come into contact with the surfaces of the appliance. Therefore please note:

- Do not allow these agents to come into contact with the surfaces of the appliance.
- Clean the appliance with nothing but water and a soft, damp cloth.
- Remove any detergent, spray or other residues immediately.



Environmental protection

Packaging/used appliance



Dispose of packaging in an environmentally-responsible manner.

This appliance is labelled in accordance with European Directive 2012/19/EU concerning used electrical and electronic appliances (waste electrical and electronic equipment - WEEE).

The guideline determines the framework for the return and recycling of used appliances as applicable throughout the EU.

Tips on economical use

- Always fill the appliance with the maximum amount of laundry for each programme.
Overview of programmes →: Supplementary sheet for the installation and operating instructions.
- Wash normally soiled laundry without pretreating.
- For light and normal soiling in laundry, you can save energy and detergent.
- Dosing the detergent using the **intelligent dosing system** (i-Dos) helps to save both detergent and water.
- The selectable temperatures apply to the care labels on the textiles. The temperatures in the appliance may deviate from this so that you get the optimum mix of energy-saving and washing results.

- **Energy-saving mode:** If the appliance is not operated for a prolonged period (approx. 5 minutes), the Touch-Display lighting goes out before the programme starts and when the programme has ended to save energy, power button flashes. Touch any area of Touch-Display to activate the lighting. When the programme is running, most of the Touch-Display lighting goes out. Touch any area of Touch-Display to activate the lighting.
- **Automatic switch off:** If the appliance is not operated for a prolonged period (at least 20 minutes, depending on the water level inside of appliance), it will automatically switch off before the programme starts or after the programme has ended. Press the power button ① again to switch on the appliance.
Note: If Wi-Fi is switched on at the appliance, when it is in Energy saving mode, the appliance will not automatically switch itself off.
- If the washing will be dried in a dryer, select the spin speed according to the dryer manufacturer's instructions.

Positioning and connecting

Standard accessories

Note: Check the appliance for transport damage. Never use a damaged appliance. If you have any complaints, contact the dealer from whom you purchased the appliance or our Customer Service.

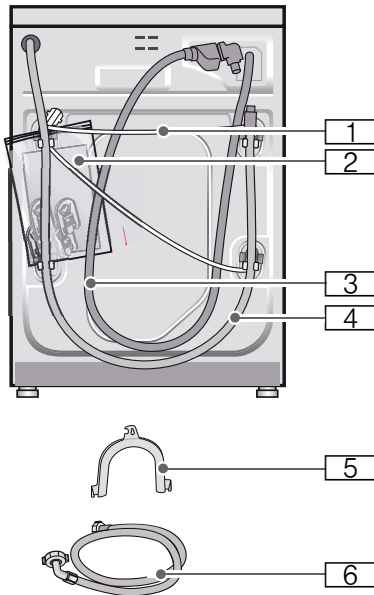

- 1 Mains lead
 - 2 Bag:
 - Installation and operating instructions
 - Customer Service location directory*
 - Warranty*
 - Supplementary sheet for the installation and operating instructions*
 - Cover caps for openings after the transport braces have been removed
 - Home Connect Installation Guides*
 - 3 Water inlet hose on aquaStop models
 - 4 Water outlet hose
 - 5 Elbow for securing the water outlet hose*
 - 6 Cold water inlet hose on Standard/Aqua-Secure models
- * Depending on the model

In addition, a hose clamp (24 - 40 mm diameter, available from specialist retailers) is required to connect the water outlet hose to a siphon.

Useful tool

- Spirit level for aligning
- Wrench with:
 - WAF13 for loosening the transport braces and
 - WAF17 for aligning the appliance feet

Safety instructions

Warning **Risk of injury!**

- The appliance is very heavy. Be careful when lifting/transporting the appliance.
- When the appliance is lifted by its protruding parts (e.g. the appliance door), the components may break off and cause injuries. Do not lift the appliance by protruding parts.
- If the hose and mains cables are not routed properly, there is a risk of tripping and injury. Lay hoses and cables in such a way that there is no risk of tripping.

Caution!

Damage to the appliance

Frozen hoses may rip/burst. Do not install the appliance in areas exposed to frost or outdoors.

Caution!

Water damage

The connection points for the water supply hose and water drain hose are under high water pressure. To prevent leaks and water damage, you must follow the instructions in this section.

Notes

- In addition to the safety information listed here, the local water and electricity supplier may have special requirements.
- If in doubt, have the appliance connected by a specialist.

Installation surface

Note: The appliance must be stable aligned so that it does not move around.

- The installation surface must be firm and level.
- Soft floors/floor coverings are not suitable.

Installation on a base or a wooden joist floor

Caution!

Damage to the appliance

The appliance may "wander" and tip/topple from the base when spinning. The feet of the appliance must be secured with holding brackets. Order no. WMZ 2200, WX 975600, CZ 110600, Z 7080X0.

Note: On wooden joist floors, install the appliance:

- In a corner, if possible,
- On a water-resistant wooden board (min. 30 mm thick) which is screwed tightly to the floor.

Installation on a platform with drawer

Platform order no.: WZ20495.

Installing the appliance in a kitchenette

Warning **Risk of death!**

There is a risk of electric shock if you touch live components.
Do not remove the appliance covering plate.

Notes

- Recess width of 60 cm required.
- Only install the appliance underneath a continuous worktop that is securely connected to adjacent cabinets.

Removing the transport locks

Caution! **Damage to the appliance**

- The appliance is secured for transportation using transport locks. If the transport locks are not removed, the appliance may become damaged when it is operated. Before using the appliance for the first time, make sure that you completely remove all four transport locks. Keep the locks in a safe place.
- To prevent transport damage from occurring if the appliance is moved at a later date, you must refit the transport locks before transporting the appliance.

Note: Keep the screws and sleeves in a safe place.

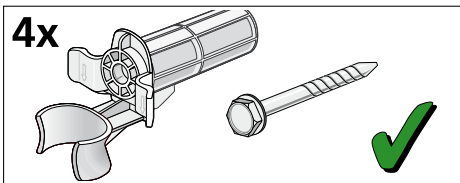

1. Take the hoses out of the holders.

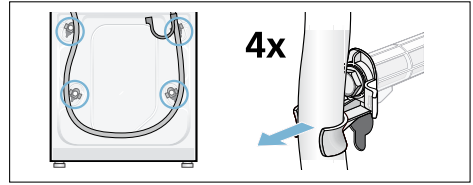

2. Unscrew and remove all four transport brace screws. Remove the sleeves. To do this, remove the mains cable from the holders.

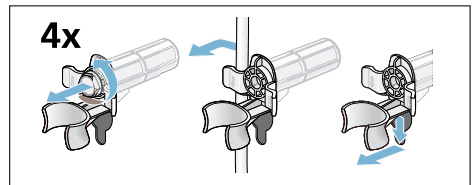

3. Fit the covers. Lock the covers firmly in place by applying pressure to the snap-in hooks.

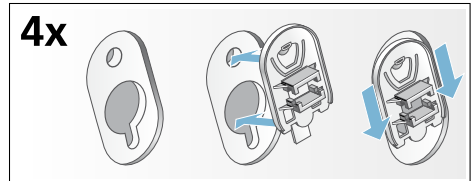

Hose and cable lengths

- Left-hand connection

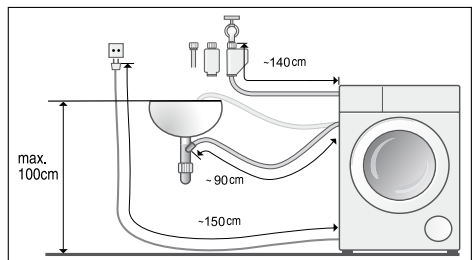

en Positioning and connecting

■ Right-hand connection

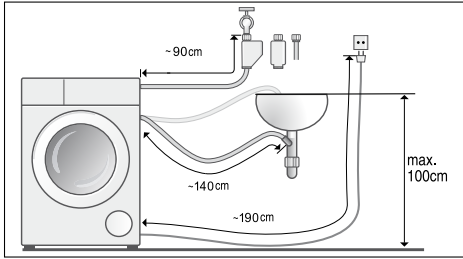

Tip: The following are available from specialist dealers/the after-sales service:

- An extension for Aqua-Stop or cold water supply hose (approx. 2.50 m); order no. WMZ2380, WZ10130, CZ11350, Z7070X0
- A longer supply hose (approx. 2.20 m) for standard model

Water inlet

⚠ Warning **Risk of death!**

There is a risk of electric shock if you touch live components.

Do not immerse the Aqua-Stop safety valve* in water (it contains an electric valve).

* Depending on the model

Observe the following when connecting the appliance:

Notes

- Only operate the appliance using cold mains water.
- Do not connect the appliance to the mixer tap of an unpressurised hot-water boiler.
- Do not use a used supply hose. Only use the supply hose supplied or one that was purchased from an authorised specialist retailer.
- Do not bend, squash, modify or cut through the water supply hose (otherwise its strength is no longer guaranteed).

- Only tighten the screw connections by hand. If the screw connections are tightened too much with a tool (pliers), the thread may be damaged.

Optimum water pressure in the supply network

At least 100 kPa (1 bar)

Maximum 1000 kPa (10 bar)

When the tap is open, the water flow is at least 8 l/min.

If the water pressure is higher than this, a pressure-reducing valve must be installed.

Connection

1. Connect the water supply hose to the water tap ($\frac{3}{4}$ " = 26.4 mm) and to the appliance:

– Model: **Standard**

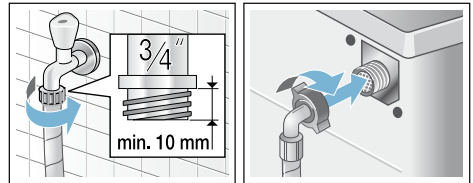

– Model: **Aqua-Secure**

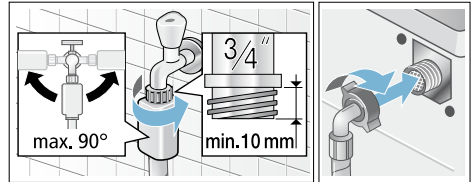

– Model: **Aqua-Stop**

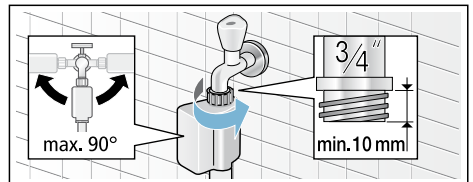

Tip: Connect also an external water filter (depending on the model) between water supply hose and tap. The filter filters dirt particles out of the water.

Water filter must be cleaned regularly to remove contaminants. This will prevent blockages. See also → separate installation and cleaning instruction for water filter.

2. Open the water tap carefully, checking the leak tightness of the connection points. The screw connection is under mains water pressure.

Water outlet

Warning

Risk of scalding!

When you are washing at high temperatures, there is a risk of scalding if you come into contact with hot water (e.g. when draining hot water into a washbasin).

Do not reach into the hot water.

Caution!

Water damage

If the drain hose slips out of the washbasin or the connection point during draining due to high water pressure, any escaping water may cause water damage.

Secure the drain hose so that it cannot slip out.

Caution!

Damage to the appliance/fabrics

If the end of the drain hose is immersed in the drained water, water may be sucked back into the appliance and may damage the appliance/fabrics. Make sure that:

- The plug does not block drainage from the washbasin.
- The end of the drain hose is not immersed in the drained water.
- The water drains away quickly enough.

Note: Do not kink the water drain hose or put strain on it lengthways.

Connection

- **Drainage into a washbasin**

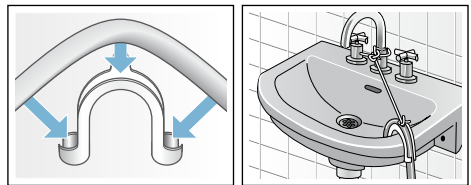

- **Drainage into a siphon**

The connection point must be secured using a hose clamp with a diameter of 24 - 40 mm (available from specialist dealers).

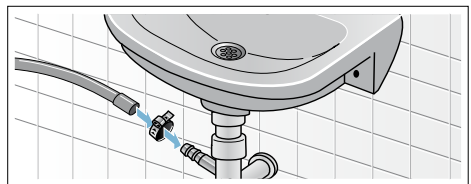

- **Drainage into a plastic pipe with rubber bushing or into a drainage pit**

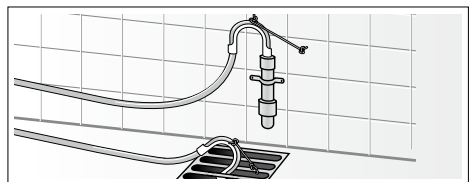

Alignment

Level the appliance using a spirit level. Incorrect levelling may result in intense noise, vibrations and "wandering".

1. Loosen the lock nuts using a wrench, by turning it in a clockwise direction.
2. Check the alignment of the appliance with a spirit level, and adjust it if necessary. Change the height by turning the appliance feet. All four appliance feet must stand firmly on the ground.
3. Tighten the lock nut against the housing.

In doing so, hold the foot tight and do not adjust its height. The lock nuts on all four appliance feet must be screwed tightly against the housing.

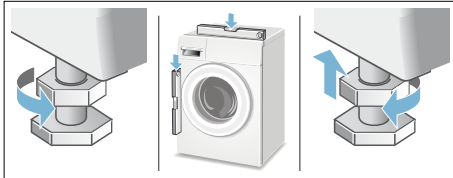

Electrical connection

Warning **Risk of death!**

There is a risk of electric shock if you touch live components.

- Never touch or hold the mains plug with wet hands.
- Only pull out the mains cable by the plug and never by the cable, as this could damage it.
- Never unplug the mains plug during operation.

Observe the following information and ensure that:

Notes

- The mains voltage and voltage indicated on the appliance (rating plate) are the same. The connected load and fuse required are specified on the rating plate.
- The appliance is only connected to an alternating current via a properly installed earthed socket.
- The mains plug fits the socket.
- The cable cross-section is adequate.
- The earthing system is properly installed.
- The mains cable is only replaced by a qualified electrician (if this is necessary). Replacement mains cables are available from the after-sales service.
- No multiple plugs/couplings or extension cables are used.
- If an earth-leakage circuit breaker is used, only a type which displays this symbol is used: . Only this symbol guarantees compliance with the currently applicable regulations.
- The mains plug can be accessed at all times.
- The mains cable is not bent, squashed, modified, cut through, or in contact with heat sources.



Before washing for the first time

The appliance was thoroughly tested before leaving the factory. To remove any water that may be left over from the test, run the first wash cycle **without** any laundry.

Notes

- The appliance **must be correctly installed and connected**.
- Never use a damaged appliance. Inform customer services.

Preparatory work:

1. Check the appliance.
2. Fill the dispenser  and .
3. Plug into the mains.
4. Turn on the tap.

Run the programme without laundry.

1. Switch on the appliance.
2. Close the door (do not load any laundry).
3. Set the  **Drum Clean 90 °C** programme.
4. Open the detergent drawer.
5. Pour approx. 1 litre of water into the left-hand compartment.
6. Pour standard detergent into the left-hand compartment.

Note: To prevent foaming, only use half of the amount of detergent recommended by the detergent manufacturer. Do not use detergents designed for woollens or delicates.

7. Close the detergent drawer.
8. Start the programme.
9. Switch off the appliance at the end of the programme.

Your appliance is now ready to use.

Transportation

e.g. when moving home

Preparatory work:

1. Turn off the water tap.
2. Reduce the water pressure in the supply hose → *Page 48*
3. Drain any residual water → *Page 47*
4. Disconnect the appliance from the mains.
5. Remove the hoses.
6. Empty the dispensers → *Page 45*

Installing the transport locks:

1. Remove the covers and keep them in a safe place.
Use a screwdriver if necessary.

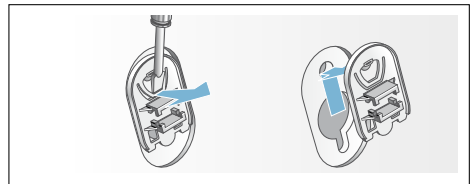

2. Insert all four sleeves.
Clip the mains cable securely in the holders. Insert and tighten the screws.

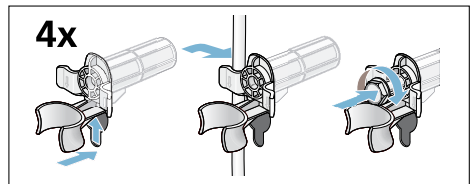

Before switching on the appliance again:

Notes

- The transport braces **must** be removed.
- Pour approx. 1 litre of water into left-hand compartment, select the  **Spin** programme and start. This will prevent detergent from flowing straight into the drain during the next wash.

Getting to know the appliance

Appliance

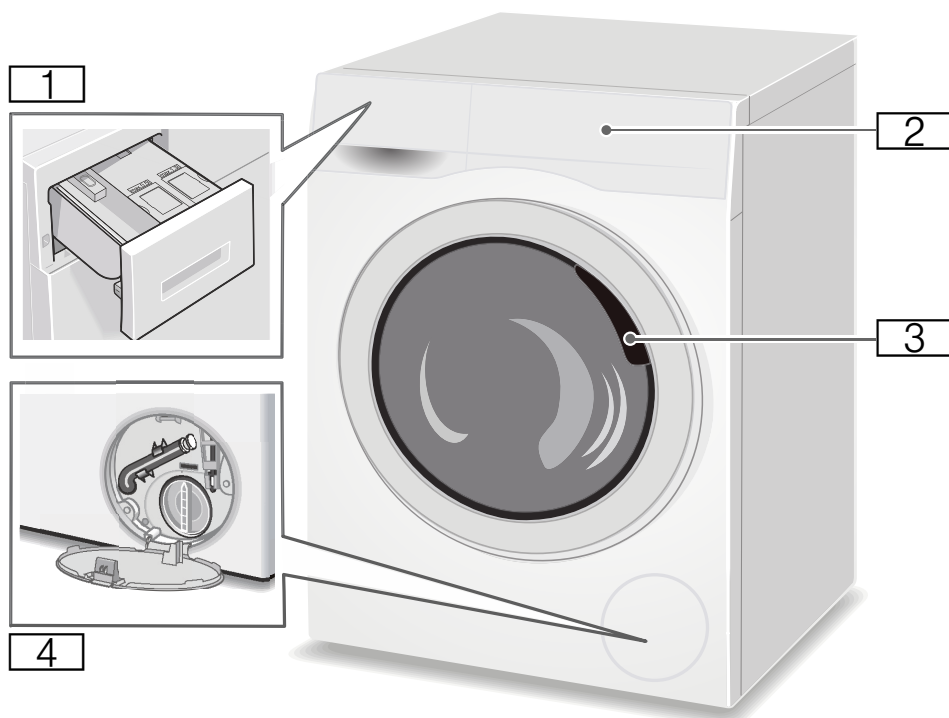

- 1 Detergent drawer
- 2 Operating/Touch-Display
- 3 Loading door
- 4 Service flap

Control panel

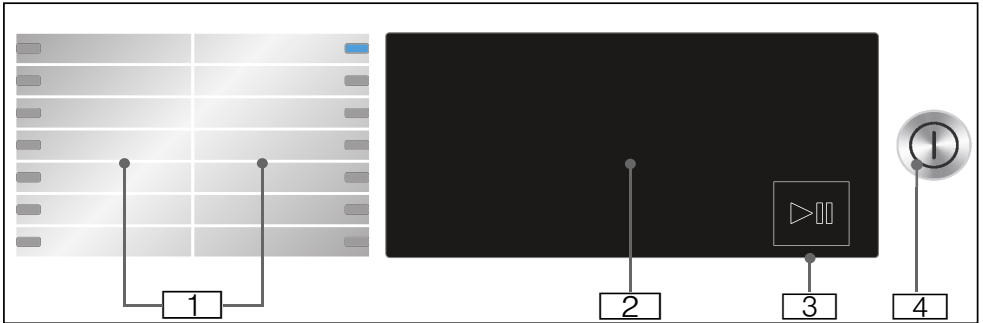

- 1** Programmes that can be selected.
- 2** Touch-Display
- 3** Start/Pause button
Touch >|| button to start, interrupt (e.g. reload washing) and cancel the programme.
- 4** Power button
Press the ⏻ button to switch the appliance on/off.

Touch-Display

Caution!

Material damage/damage to the appliance.

Exerting excessive pressure on the display may damage it. Do not use a sharp object on the display or exert excessive pressure on it.

Note: The display on this appliance responds to touch (touch display). You can activate settings by touching lightly on the touch-sensitive buttons in boxes. The activated settings are illuminated particularly brightly to highlight them on the display. You can change or deactivate the activated settings by repeatedly touching on the relevant buttons on the display.

Programme default settings

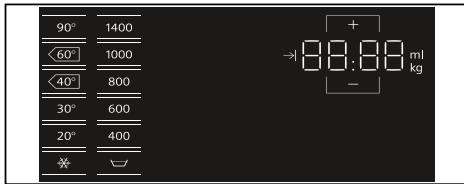

Display	Setting	Description
✳ - 90°C	Temperature	Temperature that can be set in °C ✳ = cold
🪣, 400 - 1400*	Spin speed	Spin speed in rpm (revolutions per minute) 🪣 = Rinse hold
2:30*	Programme remaining time	Programme remaining time depends on the programme selection in h:min (hours:minutes)
0.5 - 24 h	"Finish in" time	Programme ends after ... h (h = hours)
9.0* kg	Maximum load	Recommended load in kg
* Depending on the selected programme		

Additional programme settings



Display	Setting
🪣	Soaking
🪣+	Rinse plus
⌚	Speed
🌀	Eco
🪣↓	Prewash
🪣+	Water plus
🪣	Easy iron
☆	Memory programme
🪣	Silent wash
📺	Remote start → <i>Page 29</i> and Home Connect settings → <i>Page 37</i>

Status indicators for the programme progress (programme sequence)



Display	Setting
▶⏸	Start/Pause button
🪣	Pretreatment
🪣	Wash
🪣	Rinse
🌀	Spin/Drain
End	Programme end

Further settings

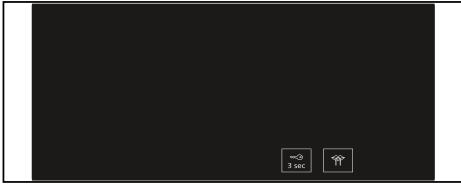

Display	Setting/Description
3 sec	<p>Childproof lock:</p> <p>To prevent the set functions from being changed accidentally:</p> <p>To do so, touch and hold 3 sec button for approx. 3 seconds.</p> <p>→ "Childproof lock" on page 32</p>
	Basic settings → Page 43

Laundry

Preparing the laundry

Caution!

Damage to the appliance/fabrics

Foreign objects (e.g. coins, paper clips, needles, nails) may damage the laundry or components in the appliance.

Therefore, note the following tips when preparing your laundry:

- Empty any pockets.

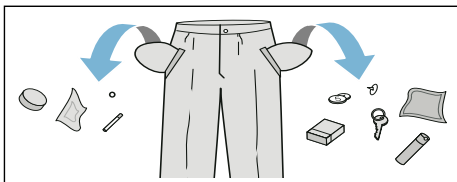

- Check for metal items (paper clips, etc.) and remove them.

- Wash delicates in a laundry bag (tights, underwired bras, etc.).

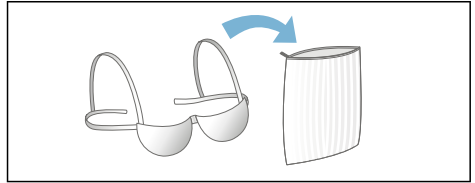

- Remove curtain fittings or place curtains in a laundry bag.
- Close any zips, button up any cover buttons.
- Brush sand out of pockets and collars.

Sorting laundry

Sort your laundry according to the care instructions and manufacturer's information on the care labels:

- Type of fabric/fibre
 - Colour
- Note:** Laundry can discolour or not be cleaned correctly. Wash white and coloured laundry separately. Wash new bright fabrics separately the first time you wash them.
- Soiling
 - Wash laundry with the same level of soiling together.
 - You can find examples of levels of soiling on
 - **Light:** Do not pretreat, select the **Speed** setting if necessary.
 - **Normal**
 - **Heavy:** Load less laundry, pretreat the laundry if necessary.
 - **Stains:** Remove/pretreat stains while they are fresh. First, dab the stain with soapy water/do not rub. Then wash the items of laundry with the appropriate programme. Stubborn/dried-in stains can sometimes only be removed with several washes.

- Symbols on the care labels
The numbers in the symbols indicate the maximum washing temperature which may be used.
 - : Suitable for a normal washing process; e.g. **Cottons** programme.
 - : A gentle washing process is required; e.g. **Easy-Care** programme.
 - : An especially gentle washing process is required; e.g. **Delicates/Silk** programme.
 - : Suitable for washing by hand; e.g. **Wool** programme.
 - : Do not wash the laundry in the appliance.

Starching

Note: Laundry should not be treated with fabric softener.

1. Switch on the appliance.
2. Select the **Rinse** programme.
3. Manually add the dosage of liquid starch into the left-hand dispenser (if required, clean it beforehand) in accordance with the manufacturer's instructions.
4. Touch the button.

Dyeing/bleaching

Dye should only be used in normal household quantities. Salt may damage stainless steel. Always follow the dye manufacturer's instructions.

Do **not** use the appliance to bleach clothes.

Detergent

Correct selection of detergent

The care label is crucial for selecting the correct detergent, temperature and treatment of the laundry. → See also www.sartex.ch

If you visit www.cleanright.eu, you will find further information on detergents, care products and cleaning agents for domestic use.

- **Standard detergent with optical brighteners**
Suitable for boil-washable white laundry made from linen or cotton
Programme: Cottons/
cold - max. 90 °C
- **Detergent for colours without bleach or optical brighteners**
Suitable for coloured laundry made from linen or cotton
Programme: Cottons/
cold - max. 60 °C
- **Detergent for colours/delicates without optical brighteners**
Suitable for coloured laundry made from easy-care fibres, synthetic fibres
Programme: Easy-Care/
cold - max. 60 °C
- **Detergent for delicates**
Suitable for delicate, fine fabrics, silk or viscose
Programme: Delicate/Silk/
cold - max. 40 °C
- **Detergent for woollens**
Suitable for wool
Wool programme/
cold - max. 40 °C

Saving energy and detergent

For light and normal soiling, you can save energy (lower washing temperature) and detergent.

Saving	Soiling/note
 <p data-bbox="68 312 244 443">Reduced temperature and detergent quantity as per the recommended dosage</p> <p data-bbox="68 954 244 1144">Temperature as per the care label and detergent quantity as per the recommended dosage for heavy soiling</p>	<p data-bbox="247 312 532 336">Light</p> <p data-bbox="247 341 532 416">No visible dirt or stains. Clothing has taken on some body odour, e.g.:</p> <ul data-bbox="247 421 532 614" style="list-style-type: none"> <li data-bbox="247 421 532 496">■ Light summer/sports clothing (worn for a few hours) <li data-bbox="247 501 532 550">■ T-shirts, shirts, blouses (worn for up to one day) <li data-bbox="247 555 532 614">■ Guest bed linen and hand towels (used for one day)
	<p data-bbox="247 619 532 643">Normal</p> <p data-bbox="247 647 532 697">Visible dirt or a few light stains, e.g.:</p> <ul data-bbox="247 702 532 949" style="list-style-type: none"> <li data-bbox="247 702 532 777">■ T-shirts, shirts, blouses (sweat soaked, worn a few times) <li data-bbox="247 782 532 949">■ Towels, bedding (used for up to one week)
	<p data-bbox="247 954 532 978">Heavy</p> <p data-bbox="247 983 532 1058">Dirt and/or stains clearly visible, e.g. tea towels, baby items, work clothing</p>

Note: When measuring the amount of all detergents/additives/care products and cleaning agents, please always check the manufacturer's instructions and information.

P+ Programme default settings

You can change the default settings for selected programmes. The settings can be changed even while the selected programme is running. The effects depending on the progress of the programme.

Temperature

(°C)

Depending on what stage the programme is in, you can change the temperature before and during the programme.

The maximum temperature that can be set depending on the model and the programme that has been selected.

Spin speed

(☺)

Depending on what stage the programme is in, you can change the spin speed (in rpm; revolutions per minute) before and during the programme.

setting ☹: “Rinse hold” = no final spin. The laundry stays in the water after the final rinse.

You can select “Rinse hold” to prevent creasing if the laundry will not be taken out of the appliance immediately after the programme has ended.

To continue/end the programme → *Page 33*

The maximum speed that can be set depending on the model and the programme that has been selected.

Finish in

(→)

After selecting a programme, the programme duration is displayed, e.g. **1:51** (in h:min (hours:minutes)).

Before the programme starts, you can move the time at which the programme should be finished backwards, in increments of 30 minutes and up to a maximum of 24 h (h=hour).

To do this:

1. Select a programme (except  **myTime** programme). The programme duration is displayed for the selected programme, e.g. **2:30** (hours:minutes).
2. Touch the + button repeatedly until the required number of hours is displayed.

Note: The setting values are increased using the + button, and decreased using the – button.

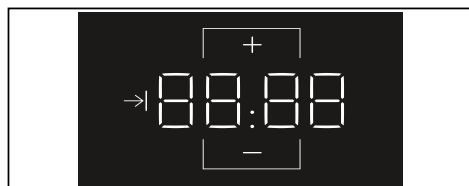

3. Touch the ▷ button.

After the programme starts, the selected time, e.g. **8 h** is displayed and counted down until the washing programme starts. The duration of the programme is then displayed.

Note: The length of the programme is automatically adjusted when the programme is running. Changes to the default programme settings or programme additional settings may also change the programme duration.

After the programme starts, and while the selected time is counting down, you can change this as follows:



1. Touch the ▷ button.
2. Touch + or – button to change the number of hours.
3. And touch the ▷ button again.

i-Dos setting

Your appliance has an intelligent dosing system for liquid detergent and fabric softener.

The appliance doses your detergent and fabric softener automatically in most programmes.

The following have been preset at the factory:

-  i-Dos: ∆
Detergent dosage for lightly soiled laundry
-  i-Dos: ∆∆
Fabric softener dosage for a medium level of softness

i-Dos for detergent

Adjustment values for the dosage quantity

- ∆ Light:
For lightly soiled laundry
- ∆∆ Medium:
For normally soiled laundry
- ∆∆∆ Heavy:
For particularly heavy soiling and/or staining
- off Automatic dosing deselected, manual dosage

You can change the settings for automatic detergent dosing before the washing programme starts and during prewash (if selected). Touch the  **i-Dos** for this.

You can find information on degrees of soiling on.

i-Dos for fabric softener

Adjustment values for dosage quantities

- ∅ Light:
For slightly soft laundry
- ∅∅ Medium:
For laundry with a medium level of softness
- ∅∅∅ Heavy:
For particularly soft laundry
- off Automatic dosing deselected

Depending on what stage the programme is in, you can change the settings for automatic detergent dosage. Touch the  **i-Dos** for this.

P+ Additional programme settings

Note: You can find possible programme additional settings in the overview; these differ depending on the model.

By selecting additional settings, you can better adapt the washing process to your items of laundry.

The settings can be selected or deselected depending on the progress of the programme.

The button indicator lamps light up if a setting is activated.

The settings are not retained after the appliance is switched off.

Speed

(≡⏸)

Washing in a shorter time while achieving a washing result that is consistent with, but uses more energy than the selected programme without the **Speed** setting.

Note: Do not exceed the maximum load.

Eco

(@)

Energy-optimised washing by reducing the temperature while achieving a washing result that is consistent with the selected programme without the **Eco** setting.

Prewash

(⏸)

For heavily soiled laundry.

Notes

- If **intelligent dosage is selected**, the detergent will be dispensed automatically for the prewash and the main wash.
- For heavily soiled laundry, **medium** dosing is usually sufficient when selecting a programme with  (**Prewash**).
- If **dosing manually**, allocate detergent to the prewash and the main wash. Place detergent for the prewash in the drum and add washing powder for the main wash to the left-hand compartment.

Water plus



Increased water level, gentler treatment of the laundry.

Easy iron



Reduces creasing thanks to a special spin sequence followed by fluffing and reduced spin speed.

Note: The washing's residual moisture is increased.

Soaking



Before the main wash cycle starts, the washing remains for longer in the water to partially dissolve intensive soiling.

10'	10 minutes
20'	20 minutes
30'	30 minutes



Notes

- Put detergent in the drum.
- Load laundry of the same colour.

Rinse plus



Settings that can be selected:

-  **+ 1 rinse cycle**
-  **+ 2 rinse cycles**
-  **+ 3 rinse cycles**

Additional rinse cycles for particularly sensitive skin and/or for areas with very soft water.

Longer programme duration.

The number of rinse cycles that the appliance actually runs depends on the number that is set as a basic setting for the program in question.

Memory programme



You can save a selected programme with your favourite settings here.

To store:

1. Switch on the appliance.
2. Select a programme.
3. If required, change the programme default settings and/or select programme additional settings.
4. Touch and hold ☆ button for approx. three seconds.

The programme is saved if all of the settings flash briefly.

To use the saved programme, touch ☆ button briefly after you switch on the appliance.

To change the saved programme, touch and hold ☆ button again for approx. three seconds after selecting the new settings.

Silent wash



Reduced noise values thanks to special wash and spin cycle and deactivated end signal. Especially suitable for washing at night.

Note: Residual moisture of the washing is slightly increased. The spin result is may not satisfactory. You can select **Spin** programme before hanging.

Remote start



()

Touching  allows you to start the programme remotely via the Home Connect app or to call up the Home Connect settings.

Enabling the programme to be started remotely via the Home Connect app:

Note: Remote start can only be activated if the appliance door is closed and the appliance is connected to your home network.

- Briefly touch .

Note: Remote start will be deactivated for safety reasons in the following circumstances:
 You open the door.
 There is a power failure.
 Once the programme has ended.
 If you touch  on the appliance.
 If you briefly touch  again.
 If you press  to switch off the appliance.

Calling up Home Connect settings:

- Touch and hold  for at least 3 seconds.

Operating the appliance

Preparing the appliance

The appliance was tested before delivery. To remove residual water from the test procedure, the first wash cycle should be run without laundry using the  **Drum Clean** programme. Before washing for the first time
 → Page 19

Notes

- Never switch on a damaged appliance!
- Inform customer service!

1. Insert mains plug.

Warning

Risk of death from electric shock!

Risk of death if live parts are touched.

- Never pull out the mains plug by tugging the power cord.
- Insert/pull out the mains plug with dry hands only.

2. Turn the tap on.

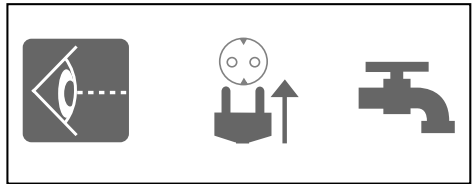

3. Open the appliance door.

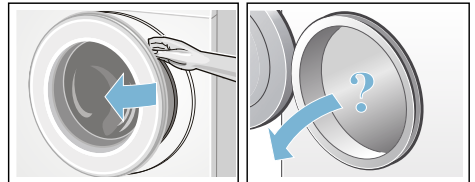

Switching on the appliance/ selecting a programme

Press the  button till the indicator lamp lights up, release the button. The appliance is switched on.

The  **Cottons** programme, which is preset at the factory, is then always displayed.

You can use this programme or select a different programme.

Note: If you have activated the childproof lock, you must deactivate it before you can set a programme.

Presettings and maximum load are indicated on the Touch-Display for the selected programme:

You can use the displayed presettings or adjust the selected programme optimally to the items of washing by changing the → *"Programme default settings"* on page 25 and/or selecting → *"Additional programme settings"* on page 27.

Selecting additional programmes

You can select additional programmes via Home Connect app.

1. Connect the appliance to your home network and the Home Connect app.
2. Select →  **Others** programme.
RPP appears on the display panel.
Note: You can select the programmes directly via the Home Connect app.
3. Select the desired programme on the Home Connect app.
The settings of the selected programme appear on the display.

4. If necessary, adjust programme settings and touch the  button.

Note: You can start the programme also via Home Connect app by touching briefly  button on the appliance before.

Changing the programme default settings

You can use the default settings or change them.

To do this, repeatedly select the corresponding button until the required setting is displayed.

The settings are activated without needing to be confirmed.

They are not saved when the appliance is switched off.

Programme default settings
→ Page 25

Overview of programmes →
Supplementary sheet for the installation and operating instructions.

Selecting the additional programme settings

By selecting additional settings, you can better adapt the washing process to your items of laundry.

The settings can be selected or deselected depending on the programme progress.

The indicator lamp for the button lights up if a setting is activated.

The settings are not saved when the appliance is switched off.

Additional programme settings
→ Page 27

Overview of programmes →
Supplementary sheet for the installation and operating instructions.

Placing laundry into the drum

Warning **Risk of death!**

Items of laundry pretreated with cleaning agents that contain solvents, e.g. stain remover/cleaning solvent, may cause an explosion after being loaded into the appliance. Hand-rinse these items of laundry thoroughly beforehand.

Notes

- Mix items of laundry of varying sizes. Laundry items of different sizes distribute themselves better during the spin cycle. Individual laundry items may cause an unbalanced load.
 - Observe the maximum specified load. Overfilling adversely affects the washing result and promotes creasing.
1. Unfold presorted laundry items and place them in the drum.
 2. Make sure that no items of laundry are trapped between the door and the rubber seal, and close the door.

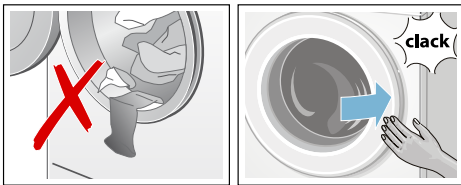

Measuring and adding detergent and care products

For the majority of programmes on your appliance, detergent and fabric softener are dosed automatically; it is a factory setting for these programmes and can be changed.

In addition to intelligent dosing, you can add cleaning aids (e.g. softener, bleach or stain remover) to the left-hand compartment, if necessary.

For programmes without intelligent dosing, or as required (in which case, set intelligent dosing to "off"), detergent can be added manually to the left-hand compartment.

Starting the programme

Touch and hold  for 1~2 seconds, then release the button. The programme starts and the appliance door is locked.

The **Finish in** time is shown in the Touch-Display and counts down until the programme starts. After the washing programme has started, the programme duration is displayed. And the displays for the programme's progress light up. → "Touch-Display" on page 22

Note: Foam detection

If the symbol  also lights up in the Touch-Display, the appliance has detected too much foam during the wash cycle and automatically activated additional rinse cycles to remove the foam.

If you want to lock the programme to prevent it from being adjusted inadvertently, you can select the childproof lock.

Childproof lock

(🔒 3 sec)

You can lock the appliance to prevent the functions you have set from being changed inadvertently in the control panel.

To activate the childproof lock:

After the programme starts, touch and hold the 🔒 **3 sec** button for approx. three seconds. The display switches to full brightness.

If you touch the control panel while the childproof lock is activated, the 🔒 **3 sec** indicator will flash briefly and a signal will sound. The programme runs through to the end unchanged.

Note: When the programme ends, **End** is displayed. The door is closed.

🔒 **3 sec** indicator still lights up and 🔒 symbols remain on to remind you to deactivate the childproof lock.

To deactivate the childproof lock:

Touch and hold the 🔒 **3 sec** button until the indicator turns off.

Notes

- To remove the laundry at the end of the programme, deactivate the childproof lock.
- The childproof lock remains active, even once the appliance has been switched off.
- If the appliance is switched off while the programme is running and childproof lock is activated, the programme continues when the appliance is switched back on.

Adding/removing laundry

After starting the programme, you can add or remove laundry if necessary.

Touch the ▷ button. The appliance checks whether reloading is possible.

If the following appears on the Touch-Display:

- The symbol 🔒 disappears, reloading is possible.
- The symbol 🔒 lights up, reloading is not possible.

To continue the programme, touch the ▷ button. The programme continues automatically.

Notes

- Do not leave the door open for too long when adding laundry as water from the laundry may leak out.
- For safety reasons, the door remains locked when the water level or temperature is high, or while the drum is turning, and it is not possible to add laundry during this time.

Changing the programme

If you have started the wrong programme by mistake, you can change the programme as follows:

1. Touch the ▷ button.
2. Select another programme.
3. And touch the ▷ button again. The new programme starts from the beginning.

Cancel the programme

For programmes at high temperatures:

1. Touch the ▷ button.
2. To cool down laundry: Select  **Rinse**.
3. And touch the ▷ button again.

For programmes at low temperatures:

1. Touch the ▷ button.
2. Select  **Spin**.
3. And touch the ▷ button again.

Programme end during rinse hold

The ▷ button flashes on the Touch-Display, and the preset spin speed and remaining programme length are displayed for the selected programme.



Continue the programme by:

- Touch the ▷ button or
- Change the spin speed (if necessary) and then touch the ▷ button again.

Note: If the water only needs to be drained, touch the ▷ button approx. 1 minute after the programme starts, before the spin cycle begins. Then switch the appliance off. The programme is interrupted and the door lock is released. The laundry can be removed.

Programme end

End lights up on the Touch-Display and ▷ and  displays are off.

Removing laundry/switching off the appliance

1. Press the  button till the indicator lamp turns off, release the button. The appliance is switched off.
2. Open the door and remove the laundry.
3. Turn off the tap.

Note: Not required for Aqua-Stop models.

Notes

- Do not leave any items of laundry in the drum. They may shrink in the next wash or discolour another item.
- Remove any foreign objects from the drum and the rubber seal – risk of rusting.
- Wipe the rubber seal dry.

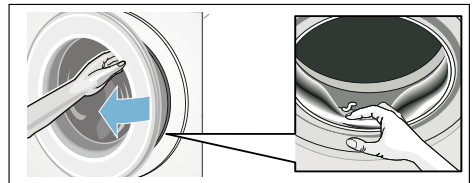

- Leave the door and detergent drawer open so that any residual water can evaporate.
- Always wait until the programme ends, as the appliance could still be locked. Then switch the appliance on and wait for it to unlock.



i-DOS

Intelligent dosing system



Intelligent dosing system in the detergent drawer

i-Dos Intelligent Dosing system

Your appliance has an intelligent dosing system for liquid detergent and fabric softener.

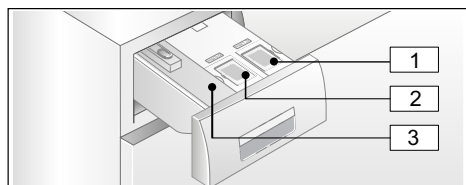
The i-Dos dispensers  and  in the detergent drawer are available for this purpose.



- 1 Dispenser  (1.3 l) for liquid detergent
- 2 Dispenser  (0.5 l) for fabric softener
- 3 Left-hand compartment for manual dosing

Depending on the selected programme and settings, the optimum quantity of detergent and/or fabric softener is dosed by the i-Dos dispensers.

Initial use/filling the dispensers

Refer to the manufacturer's instructions when choosing your detergent and fabric softener. We recommend the use of standard, universal and colour liquid detergents for all appliance-washable, coloured fabrics made of cotton or synthetic materials.

Notes

- Only use easy-pour liquid products that the manufacturer recommends adding to the detergent drawer.
- Do not mix different liquid detergents. If changing your liquid detergent (type, manufacturer, etc.), empty the dispenser completely and clean it.
- Do not use products containing solvents, caustic agents or volatile substances (e.g. bleach).
- Do not mix detergent and fabric softener.
- Do not use products that have expired or are highly congealed.
- To prevent drying out, do not leave the dispenser lids open for a long period of time.

Filling the dispensers:

The lids of the dispensers in the detergent drawer are marked with the following symbols:

-  Standard/universal detergent
-  Fabric softener

1. Open the detergent drawer.
2. Open the dispenser lid(s).
3. Add detergent and/or fabric softener. Do not fill above the **max.** marking.

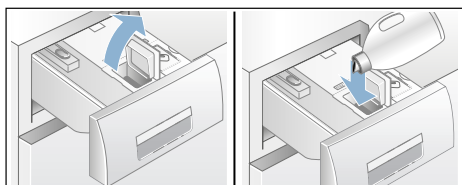

4. Close the lid(s).
5. Slowly push the detergent drawer in completely.

When the detergent drawer is fully pushed in, the display  goes out when the appliance is switched on.

Everyday use

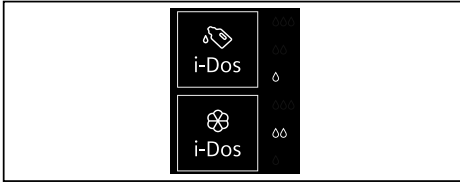

Displays:





- The display **lights up** if intelligent dosage has been selected for the dispenser.
- The display for the adjustment values, e.g. ∞∞ **flashes** if the fill level for the dispenser is below the minimum level when intelligent dosing has been selected.

(De)selecting intelligent dosage and adjusting the dosage strength:

The intelligent dosages for detergent and fabric softener are set at the factory for all programmes in which intelligent dosing can be used.

The dosage strength has been preset to ∞ (lightly soiled laundry) for detergent  and to ∞∞ (medium level of softness) for fabric softener . It can be changed individually for each programme.

In addition to intelligent dosing, washing additives (e.g. stain remover) can be added manually via the left-hand compartment.

Note: The selection (on/off) and the selected dosage strength for  **i-Dos** and  **i-Dos** are saved for each programme until they are changed again, even if the appliance is switched off.

Topping up the detergent/ fabric softener:

If the display for the selected intelligent dosing flashes, this means that the amount of detergent or fabric softener in the dispenser is below the minimum fill level. The content is sufficient for approx. three washes.

The same detergent or fabric softener can be added at any time. If you change product/manufacturer, we recommend that you clean the dispensers first.

If required, adjust the basic dosage.

Basic settings

The basic dosages are:

- **For detergents** – based on the manufacturer's recommendation for average soiling and the respective water hardness.
- **F or fabric softeners** – based on the manufacturer's recommendation for a medium level of softness.

Refer to the packaging label on your detergent/fabric softener or ask the manufacturer directly for this information.

To find out the hardness of your water supply, use a test strip or check with your water supplier.

My water hardness:



Below is an example of detergent dosages on a packaging label:

Degree of soiling → Water hardness ↓	light	normal	heavy	very heavy
soft/medium	55 ml	75 ml	120 ml	160 ml
hard/very hard	75 ml	95 ml	150 ml	180 ml

The default setting for the basic dosage is set specifically according to the area in which you live (e.g. 75 ml for detergent and 36 ml for fabric softener).

Set the basic detergent dosage according to the detergent's packaging label. Take your water hardness into consideration when doing so.



Select the basic fabric softener dosage according to how soft you would like your laundry to be.

Changing one basic dosage affects all three dosage quantities in the same way.

Notes

- Reduce the basic dosage if using a very concentrated detergent.
- If large amounts of foam are repeatedly created during washing, please check your basic dosage and dosage quantity settings. Certain types of liquid detergent can also create excessive amounts of foam. If your basic dosage and dosage quantity settings are correct, we advise you to use a different detergent.

Changing the basic dosages:

1. Touch and hold the corresponding  **i-Dos** or  **i-Dos** button for approx. 3 seconds. The preset basic dosage will appear in the Touch-Display.
2. Set the required basic dosage using the **-** or **+** buttons.

3. The setting is activated without needing to be confirmed. You can touch **i-Dos** buttons to revert to the original setting.

Note: The settings are saved until they are changed again, even if the appliance is switched off.

Manual dosage

For programmes that cannot be used with intelligent dosage, or if you would prefer to dose manually (in which case set intelligent dosage to "off"), add detergent to left-hand compartment.

Cleaning aids such as water softener, bleach and stain remover can be added to this compartment in addition to the intelligent dosage.



Warning Eye/skin irritation!

Detergent and care products may spray out if the detergent drawer is opened while the appliance is in operation. Open the drawer carefully. Rinse eyes or skin thoroughly if they come into contact with detergent/care products. If swallowed accidentally, seek medical advice.

Caution! Damage to the appliance

Cleaning agents and agents for pretreating laundry (e.g. stain removers, prewash sprays, etc.) may cause damage if they come into contact with the surfaces of the appliance. Do not allow these agents to come into contact with the surfaces of the appliance. If necessary, immediately wipe away spray residue and other residues/droplets with a damp cloth.

Notes

- When dosing all detergents, cleaning aids and cleaning agents, always follow the manufacturer's instructions.
- If dosing detergent manually, do not add additional detergent to the intelligent dosage dispenser (set intelligent dosage to "off"). This will prevent overdosing and foaming.
- Dilute viscous fabric softener and fabric conditioner with water to prevent blockages.

Dosing and adding detergent:

1. Pull out the detergent drawer.

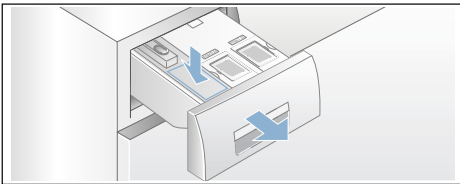

2. Add the correct dosage to left-hand compartment depending on:
 - Soiling
 - Water hardness (ask your water supply company)
 - The amount of laundry
 - The manufacturer's instructions
3. Close the detergent drawer.



Home Connect

This appliance is Wi-Fi-capable and can be remotely controlled using a mobile device.

You can use the Home Connect app to do the following on your appliance from your mobile device:

- Set up programs and launch them.
- Adjust, activate and deactivate program settings.

- Query the status of programs.
- Adjust, activate and deactivate appliance settings.
- Switch off the appliance.

Before you can use the Home Connect functions, you will need to carry out the following steps:

1. Install the Home Connect app on your mobile device.
2. Register in the Home Connect app.
3. Connect your appliance to your home network automatically **or** manually (you only need to do this the first time).
4. Connect your appliance to the Home Connect app.

You can find information about the app on our Home Connect website www.home-connect.com

Home Connect services are not available in every country. The availability of the Home Connect function depends on the availability of Home Connect services in your country. You can find information on this at: www.home-connect.com

Notes

- Please observe the safety precautions in this instruction manual and make sure that these are complied with even when operating the appliance via the Home Connect app while you are away from home. You must also follow the instructions in the Home Connect app.
- You cannot use the Home Connect app to make changes while the controls on the appliance are being operated. However, you can use the Home Connect app to see any adjustments made directly on the appliance itself.

Calling up the Home Connect menu

In the Home Connect menu, you can create and view network connections, reset network settings, activate/deactivate Wi-Fi and find other Home Connect functions.

1. Switch on the appliance.
2. Press and hold  (Remote Start) for at least 3 seconds.

RLC appears in the display.

You are now in the Home Connect menu.

Note: Briefly press  (Remote Start) to exit the Home Connect menu.

Connecting to the home network and the Home Connect app

Connect your appliance to the home network **automatically** or **manually** (you only need to do this the first time).

Notes

- If your home network router has a WPS function, you can connect the appliance to your home network automatically.
- If your home network router does not have a WPS function, you need to connect the appliance to your home network manually.

You must then connect to the Home Connect app.

Note: To connect your appliance to the home network, **Wi-Fi** must be activated on the appliance. **Wi-Fi** is deactivated on the appliance by default and is activated automatically when you connect your appliance to your home network.

Connecting to your home network automatically

Step 2.1



Ensure that you are in the Home Connect menu. → Page 38

1. Press .

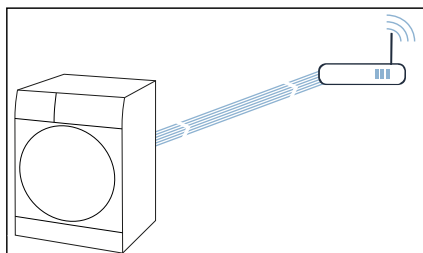
The appliance now attempts to connect to your home network.  flashes in the display.



2. Activate the WPS function on your home network router within the next 2 minutes.

If the appliance has connected to your home network successfully, **Your home appliance is connected to your home network.**  and  appear in the display and light up continuously.

Note: If you are not able to establish a connection, check whether your appliance is within range of your home network. Try connecting automatically again or connect your appliance manually.

Connecting to your home network manually

Step 2.2

Ensure that you are in the Home Connect menu. → Page 38

Make sure that you have opened the Home Connect app and are logged in.

1. Set the programme to position 2.

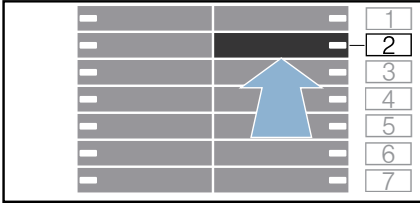

SRP (connect manually) appears in the display.

2. Press **▶**.

The appliance now sets up its own Wi-Fi network with the name (SSID) **HomeConnect**.

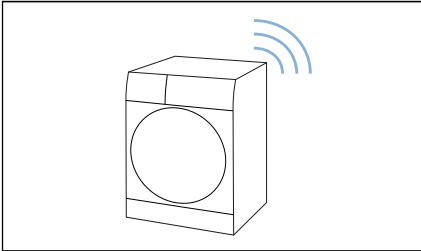

3. Call up the Wi-Fi setting on the mobile device.
4. Connect the mobile device to the **Home Connect** Wi-Fi network and enter the password (key) **HomeConnect**.
Your mobile device now connects to the appliance. The connection process may take up to 60 seconds.

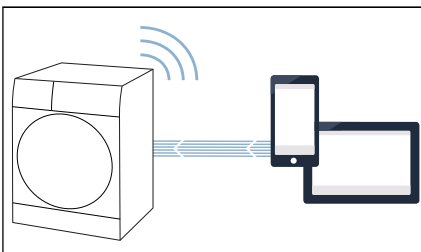

5. Once you have connected successfully, open the Home Connect app on your mobile device and carry out the steps in the app.
6. In the Home Connect app, enter the network name (SSID) and password (key) for **your home network**.
7. Carry out the last steps in the Home Connect app to connect your appliance.

If the appliance has connected to your home network successfully, **Your home appliance is connected to your home network**. **com** and **Wi-Fi** appear in the display and light up continuously.

Note: If you are not able to establish a connection, check whether your appliance is within range of your home network. Try connecting manually again.

Connecting to the Home Connect app

Step 3

If your appliance is connected to your home network, you can connect it to the Home Connect app.

Ensure that you are in the Home Connect menu. → *Page 38*

Make sure that you have opened the Home Connect app and are logged in.

1. Set the programme to position 3.

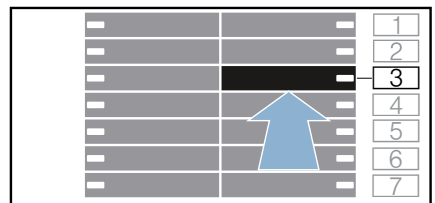

APP (connect to app) appears in the display.

2. Press **▶**.

The appliance now attempts to connect to the Home Connect app.

- Once your appliance is displayed in the app, carry out the last steps in the Home Connect app.

Note: If you were not able to establish a connection, check whether your mobile end device is within range of your home network or is connected to this. Try connecting to the Home Connect app again.

Activating/deactivating Wi-Fi

If your appliance is already connected to your home network, you can activate or deactivate **Wi-Fi** on your appliance.

Ensure that you are in the Home Connect menu. → Page 38

- Set the programme to position 4.

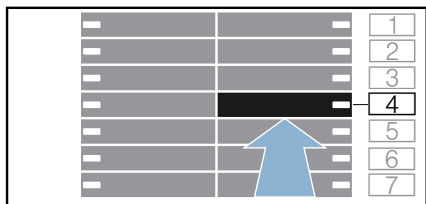

Wi-Fi (Wi-Fi) appears in the display.

- Press **OK**.
If **ON** appears in the display, Wi-Fi is activated on the appliance. If **OFF** appears in the display, Wi-Fi is deactivated on the appliance.

Notes

- If you connect to your home network, Wi-Fi is activated automatically.
- If Wi-Fi is activated, the appliance will not switch itself off automatically.
- If Wi-Fi is switched off on the appliance, it is not possible to use the Home Connect app to start or control the appliance remotely.

- If Wi-Fi is switched off and your appliance was previously connected to your home network, this connection will be re-established automatically when Wi-Fi is switched back on.
- If you activate this function, the energy consumption increases in comparison to the values specified in the consumption value table.

Resetting your network settings

You can reset all of the network settings.

Ensure that you are in the Home Connect menu. → Page 38

- Set the programme to position 5.



RES (reset network settings) appears in the display.

- Press **OK**.
YES appears in the display.
- Press **OK**.

Note: If you want to operate your appliance via the Home Connect app again, you will need to reconnect it to your home network and to the Home Connect app.

Updating the software

You can update the Home Connect software on your appliance. As soon as a new software update is available, a note appears in the display: **uPd**

Install the update directly via the **message in the display** or **manually** as follows:

Ensure that you are in the Home Connect menu. → *Page 38*

1. Set the programme to position 6.

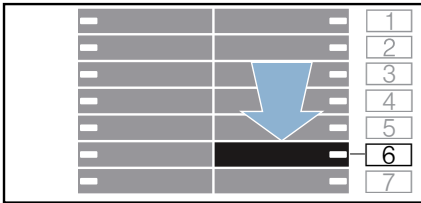

uPd (software update) appears in the display. **▷|||** flashes if a software update is available.

2. Press **▷|||**.
uEs appears in the display.
3. Press **▷|||**.

Note: The software update may take several minutes. Do not switch the appliance off while updates are being installed.

Energy management

You can connect your appliance to your smart energy system (Energy manager).

Once you have connected your appliance to the smart energy system (Energy manager) and activated the **Flex Start** function, you will be able to optimise your energy consumption because your appliance will not start up until your home photovoltaic system can provide sufficient energy or the energy tariff is good.

Further information and system requirements for using the Energy manager can be found at: **www.home-connect.com/energymanagement**

Notes

- The smart energy system (Energy manager) must use the EEBus initiative communications standard.
- Before you start, read the smart energy system instruction manual to find out how to connect your appliance to the smart energy system (Energy manager).

1. Set the programme to position 7.

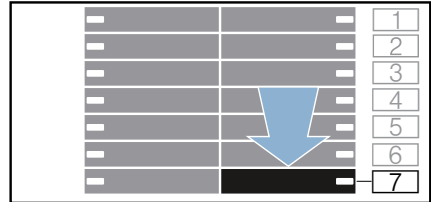

EmC (Energy manager) appears in the display.

2. Press **▷|||**.
Your appliance now attempts to connect to the smart energy system (energy manager). If the appliance has connected successfully, **com** appears in the display.
3. Activate Flexstart if you want the smart energy system (Energy manager) to start up your appliance.

Flex Start

Activate the **Flex Start** function to allow your smart energy system (Energy manager) to start your appliance once your home photovoltaic system is able to provide sufficient energy or the energy tariff is good.

Note: Your smart energy system (Energy manager) cannot start your appliance until it is connected to the appliance.

Activate **Flex Start** as follows:

1. Select the programme you require.
2. Use the + and – selection buttons for the "Finished in" time to set the required time.

Delayed start appears in the display.

3. Press ▷▢▢ .

4. Press □▢.

☺ appears in the display.

The **FlexStart** function has now been activated and the appliance will wait to be remotely started by the smart energy system (Energy manager).

If the time changes on the display to → 3.0h, for example, the smart energy system (Energy manager) has established a time at which your appliance can start. The programme will end after the specified time.

Notes

- If the smart energy system (Energy manager) does not start your appliance, the programme will still be started before the set time period ends.

The programme will end when the time period ends.

- To prevent the build-up of odours, the appliance is always started with **Flex Start** such that the laundry never remains in the drum for more than 6 hours after the programme has ended.

- For safety reasons, □▢ and in turn the **Flex Start** function will be deactivated in the following circumstances:

- Press ▷▢▢.
- Open the door.
- Programme end.
- Press ① to switch off the appliance.
- Power failure.

If the **Flex Start** function is deactivated, the **Finish in** → will remain active.

Adding more laundry or removing laundry:

Note: If the **Flex Start** function has already been activated but the programme has not yet started, you will still be able to load more laundry or remove some from the drum.

1. Press ▷▢▢ .

2. Open the door.

3. Add or remove laundry.

4. Close the door.

5. Press ▷▢▢ .

6. Press □▢.

The **FlexStart** function has now been activated and the appliance will wait to be remotely started by the smart energy system (Energy manager).

Information on data protection

When your appliance is connected for the first time to a Wi-Fi network, which is connected to the Internet, your appliance transmits the following categories of data to the Home Connect server (initial registration):

- Unique appliance identification (consisting of appliance codes as well as the MAC address of the installed Wi-Fi communication module).
- Security certificate of the Wi-Fi communication module (to ensure a secure data connection).
- The current software and hardware version of your household appliance.
- Status of any previous resetting to factory settings.

This initial registration prepares the Home Connect functions for use and is only required when you want to use these Home Connect functions for the first time.

Note: Ensure that the Home Connect functions can be used only in conjunction with the Home Connect app. Information on data protection can be accessed in the Home Connect app.

Declaration of Conformity

BSH Hausgeräte GmbH hereby declares that the appliance with Home Connect functionality meets the basic requirements and other relevant provisions of the Directive 2014/53/EU.

A detailed RED Declaration of Conformity can be found online at www.siemens-home.bsh-group.com among the additional documents on the product page for your appliance.



2.4 GHz band: max. 100 mW

Appliance settings

Automatic switch-off

If the appliance is not operated for a prolonged period (at least 20 minutes, depending on the water level inside of appliance), it will automatically switch off before the programme starts or after the programme has ended. Press the power button  again to switch on the appliance.

Note: If Wi-Fi is switched on at the appliance, when it is in Energy saving mode, the appliance will not automatically switch itself off.

Basic settings

To access the basic settings, touch and hold the  button for approx. 3 seconds. The control panel show:

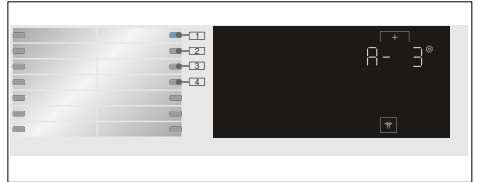

You can change the following basic settings:

- The volume of the end signal.
- The volume of the buttons.
- The brightness of the Touch-Display.
- Switching the drum care information signal on/off.

End signal

Touch and hold the  button for approx. 3 seconds. The indicator lamp in position **1** is on. You can use the + button to adjust the volume of the end signal, e.g. *A- 1*.



Possible setting values:

- | | |
|---|-----------|
| 0 | off |
| 1 | quiet |
| 2 | medium |
| 3 | loud |
| 4 | very loud |

Button signal

You can touch position **2** and use the + button to adjust the volume of the button signal, e.g. *b- 3*.

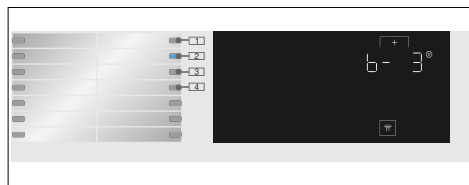

Possible setting values:

- 0 off
- 1 quiet
- 2 medium
- 3 loud
- 4 very loud

Brightness

Possible setting values: 1 - 4

You can touch position **3** and use the + button to adjust the brightness of the Touch-Display, e.g. *[- 3*.

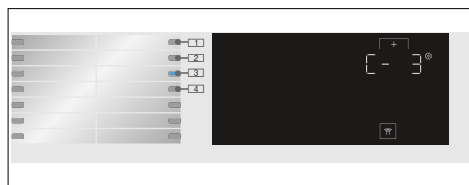

Possible setting values:

- 1 not very bright
- 2 normal level of brightness
- 3 bright
- 4 very bright

Switching the drum-care information signal on/off

You can touch position **4** and use the + button to switch the  **Drum Clean** information signal on or off, e.g. *d- 1*.

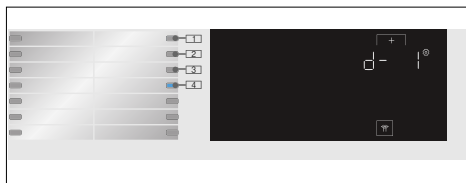

Possible setting values:

- 0 off
- 1 on

Sensors

Unbalanced load detection system

The automatic unbalanced load detection system detects imbalances and ensures even distribution of the laundry by repeatedly starting and stopping drum spinning.

If the laundry is extremely unevenly distributed, the spin speed is reduced or the spin cycle is not performed for safety reasons.

Note: Place large and small items of laundry evenly in the drum.

Aqua-Sensors

Depending on the programme and model

During a rinse cycle, the Aqua sensor checks the turbidity of the rinsing water (turbidity is caused by dirt and detergent residue). The duration and the number of rinse cycles depend on the turbidity of the water.



Cleaning and maintenance

Warning

Risk of death!

There is a risk of electric shock if touch live components.
Switch off the appliance and pull out the mains plug.

Caution!

Fire and explosion hazard!

Toxic vapours can be produced by cleaning agents that contain solvents, e.g. cleaning solvent.
Do not use cleaning agents that contain solvents.

Caution!

The appliance may be damaged!

Cleaning agents that contain solvents, e.g. cleaning solvent, can damage surfaces and components in the appliance.
Do not use cleaning agents that contain solvents.

Appliance housing/control panel

- Remove the detergent residue immediately.
- Wipe the housing and the control panel with a soft, damp cloth.
- Do not use abrasive cloths, sponges or detergents (stainless steel cleaner).
- Do not clean the appliance with a water jet.

Drum

Use chlorine-free cleaning agents, do not use steel wool.

If there are odours in the appliance, or to clean the drum, run the  **Drum Clean 90 °C** programme without laundry.

Descaling

Descaling should not be necessary if the detergent is measured out correctly. However, if it is required, follow the manufacturer's instructions for the descaling agent. Suitable descalers can be obtained via our website or from customer services.

i-Dos detergent draw and its housing

1. Emptying the dispensers:

The dispensers have emptying outlets with removable sealing plugs at the front. To empty the dispensers, first remove the drawer handle as shown below:

- a) Pull out the detergent drawer.

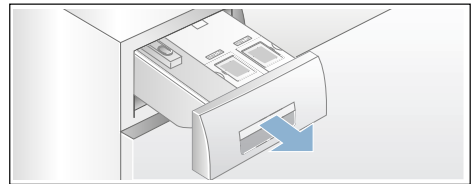

- b) Pull the catch (A) on the back of the drawer handle (in the centre at the bottom) slightly towards you. This unlocks the drawer handle (B), which you can then pull off by lifting it upwards.

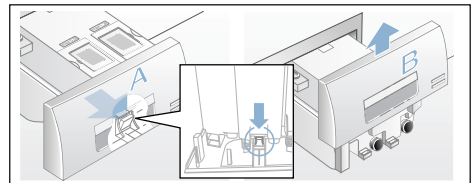

en Cleaning and maintenance

- c) To empty the dispensers, carefully pull off each of the sealing plugs and empty the contents into a suitable container.

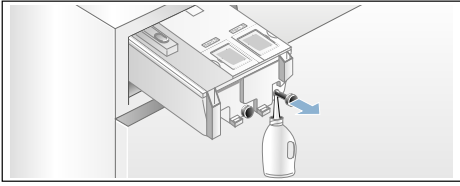

- d) Then push the sealing plugs back in completely.

2. Cleaning the dispensers/detergent drawer:

The detergent drawer can be removed completely to allow you to clean the dispensers after you have emptied them.

- a) Empty the dispensers before removing the drawer.

Note: Only put the drawer handle back on after you have finished cleaning.

- b) Pull out the drawer.
- c) Press the catch and remove the drawer completely.

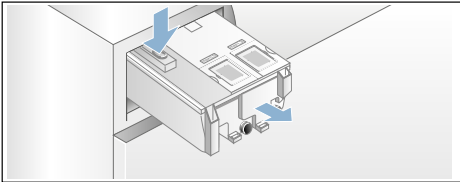

- d) Carefully remove the drawer cover.

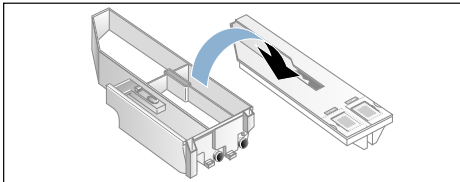

Caution!

Risk of damage to the detergent drawer.

The detergent drawer contains electrical components. These may become damaged if they come into contact with water.

- Do not clean the cover in the dishwasher and do not immerse it in water.

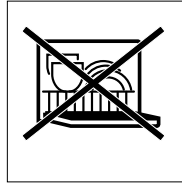

- Protect the rear drawer connector against water, detergent or fabric-softener residue; if necessary, clean the outer surfaces with a soft, damp cloth. Dry before putting back in.

- e) Clean the drawer and the cover with a soft, damp cloth or a hand shower. Also clean the inner surfaces with a soft, damp cloth.

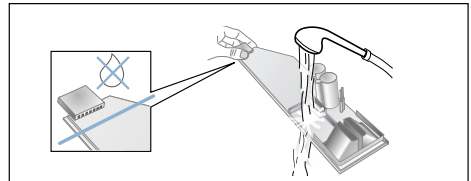

- f) Dry the drawer and the cover and put them back together.
- g) Push the drawer handle back in from above until you feel it click in place.
- h) Clean the inside of the detergent-drawer housing.
- i) Push the detergent drawer in completely.

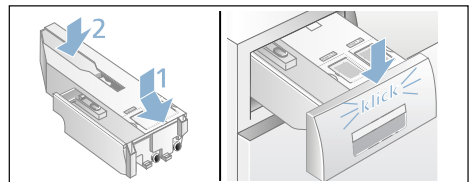

Drain pump is blocked

Note: Turn the tap off to prevent more water from flowing in and to ensure that it is drained via the pump.

⚠ Warning
Risk of scalding!

When you wash at high temperatures, the water gets very hot. If you come into contact with the hot water, you may be scalded.

Allow the water to cool down.

1. Switch off the appliance. Pull out the mains plug.
2. Open the service flap.

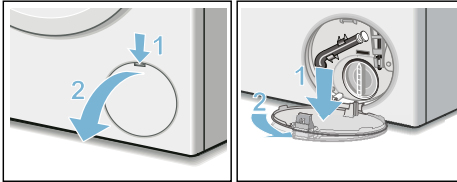

3. Take the drain hose out of the retainer.
Remove the sealing cap and pour the water out into a suitable container.
Replace the sealing cap and place the drain hose back in the retainer.

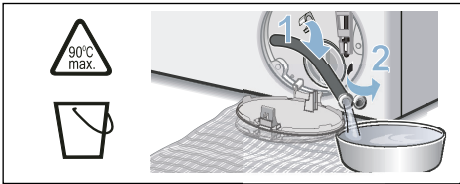

4. Carefully unscrew the pump cover; residual water may leak out.
Clean the interior, pump cover thread and pump housing. The impeller in the drain pump must be able to rotate.
Refit and screw on the pump cover. The handle must be in a vertical position.

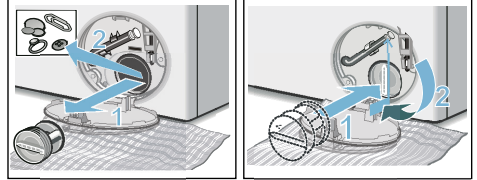

5. Close the service flap.

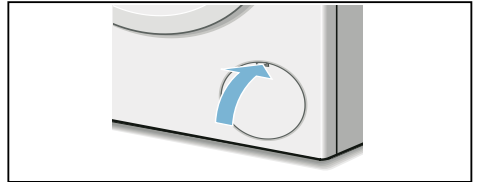

Note: To prevent unused detergent from flowing straight into the drain during the next wash: Pour 1 litre of water into left-hand compartment and start the **Spin** programme.

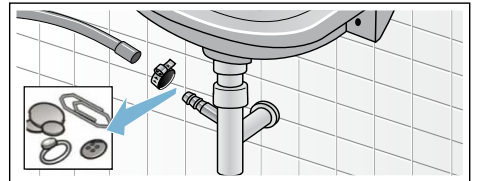

The drain hose at the siphon is blocked

1. Switch off the appliance. Pull out the mains plug.
2. Loosen the hose clamp. Carefully remove the drain hose; residual water may leak out.
3. Clean the drain hose and siphon connecting piece.



4. Re-attach the drain hose and secure the connection point using the hose clamp.

Filter in the water supply is blocked

1. Release water pressure in the supply hose:
 - a) Turn off the tap.
 - b) Select any programme (except  Rinse/Spin).
 - c) Touch the  button. Allow the programme to run for approx. 40 seconds.
 - d) Press the  button. The appliance is switched off.
 - e) Pull out the mains plug.
2. Clean the filters:
 - a) Disconnect the hose from the tap.
Clean the filter with a small brush.

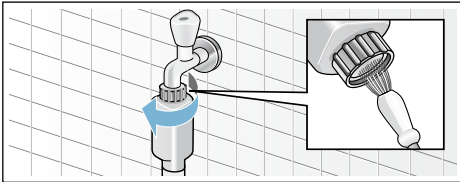

- b) For standard and Aqua-Secure models, clean the filter on the rear of the appliance: Disconnect the hose from the rear of the appliance. Use pliers to remove the filter and then clean it.

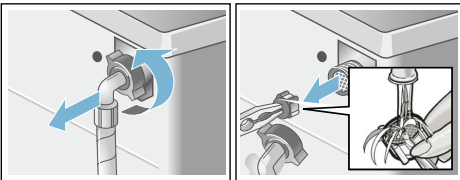

3. Connect the hose and check for leaks.

Faults and what to do about them

Emergency release

E.g. in the event of a power cut

The programme continues when the power supply is restored.

However, if the laundry has to be removed, the appliance door can be opened as follows:

Warning **Risk of scalding!**

When you are washing at high temperatures, there is a risk of scalding if you come into contact with hot water and laundry. If possible, leave it to cool down first.

Caution! **Risk when reaching into/gripping the rotating drum!**

You may injure your hands if you reach into the drum while it is turning. Do not reach into the drum when it is turning.

Caution! **Water damage!**







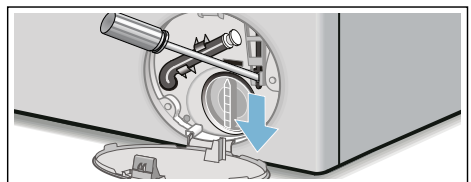



Any escaping water may cause water damage.

Do not open the door if water can be seen through the glass.

1. Switch off the appliance. Pull out the mains plug.
2. Drain the water → *Page 47*
3. Pull the emergency release downwards with a tool and release. The door can then be opened.







Information on the Touch-Display



Display	Cause/Remedy
	<ul style="list-style-type: none"> ■ Flashes fast + signal: The door was opened and the water level is too high. Close the door, continue the programme with  button or select  Spin. ■ Flashes slowly: The door lock temperature is too high to open the door. Wait approx. 30 seconds until the door lock temperature cools down.
	<ul style="list-style-type: none"> ■ Flashes (no water supply): Tap turned on? Filter in the water supply is blocked? → <i>"Filter in the water supply is blocked" on page 48</i> Is the supply hose kinked or trapped? ■ Lights up (low water pressure): For information only. This will not affect the programme progress. The programme duration is extended.
 lights up	The detergent drawer has not been pushed in completely. Push the detergent drawer in correctly.
E:3610	E:36 alternating display with -10 and End when programme is finished: <ul style="list-style-type: none"> ■ The drain pump is blocked. → <i>"Drain pump is blocked" on page 47</i> ■ The drain hose at the siphon is blocked. → <i>"The drain hose at the siphon is blocked" on page 47</i>
E:3510 (Suitable for special models)	E:35 alternating display with -10 and End when programme is finished: there is water in the base trough, the appliance is leaking. Turn off the tap. Call customer services.
E:1000/E:1010/ E:1020	E:10 alternating display with -00 or -10 or -20 : all i-Dos functions were deactivated. i-Dos needs to be repaired by customer service. You can still use the appliance without i-Dos. Add the detergent into left-hand compartment for manual dosing.
 lights up	The childproof lock is activated – deactivate it.
 ± lights up	Too much foam has been detected and an additional rinse cycle has been activated. Reduce the basic dosage of  i-Dos for the next washing cycle with the same load.
The indicator lamp of the  Drum Clean programme flashes	Run the  Drum Clean 90 °C programme to clean and care for the drum and the outer tub. <p>Notes</p> <ul style="list-style-type: none"> ■ Run the programme without laundry. ■ Use washing powder or a detergent containing bleach. To prevent foaming, only use half the amount of detergent recommended by the detergent manufacturer. Do not use detergent designed for woollens or delicates. ■ Switching the information signal on/off. → <i>"Switching the drum-care information signal on/off" on page 44</i>
	Lit: Wi-Fi is switched on and the appliance is connected to your home network. Flashing: The appliance is trying to connect to your home network. Off: Wi-Fi is switched off and the appliance is disconnected from your home network.

Display	Cause/Remedy
 0	The appliance is connected to the Smart Energy System (energy manager).
Other displays	Switch off the appliance, wait for five seconds and then switch it on again. If the display appears again, call customer services.

Faults and what to do about them

Faults	Cause/Remedy
Water is leaking from the appliance.	<ul style="list-style-type: none"> ■ Attach the drain hose correctly or replace it. ■ Tighten the screw fitting on the supply hose.
The appliance is not filling with water.	<ul style="list-style-type: none"> ■ Programme does not start? ■ Is the tap turned on?
Detergent is not being dispensed.	<ul style="list-style-type: none"> ■ Could the filter in the water supply be blocked? → <i>"Filter in the water supply is blocked" on page 48</i> ■ Is the supply hose kinked or trapped?
The dispenser is empty and the fill level indicator is not flashing.	<ul style="list-style-type: none"> ■ Is the drawer cover/connector dirty? → <i>"i-Dos detergent draw and its housing" on page 45</i> ■ Has the detergent drawer been pushed in correctly?
The wrong detergent/fabric softener has been poured into the dispenser(s).	<p>Dispenser(s):</p> <ol style="list-style-type: none"> 1. Empty and clean. 2. Refill.
Detergent/fabric softener has congealed in the dispensers.	Clean and refill the dispensers.
The door cannot be opened.	<ul style="list-style-type: none"> ■ The safety function is activated. Stop the programme? ■ Can the door only be opened by the emergency release? ■ Childproof lock activated? Deactivate childproof lock. ■ The temperature in drum is too high to open the door. Wait approx. 30 seconds until the temperature in drum cools down. ■ The water level in drum is too high.
The programme will not start.	<ul style="list-style-type: none"> ■ Have you selected  button or selected Finish in time? ■ Is the door closed? ■  lights up: the detergent drawer has not been pushed in completely. Push the detergent drawer in correctly. ■ Childproof lock activated? Deactivate childproof lock. ■ Presentation mode activated? If the display shows Shop for 5 s after you have switched on or off the appliance, the appliance is in presentation mode. Turn off the presentation mode as follows: <ol style="list-style-type: none"> 1. Switch the appliance off and on again. 2. Wait for the display message Shop to disappear. 3. Touch and hold  for at least 5 s. The display shows oFF and the appliance will automatically switch off. You can use the appliance now as usual.

Faults	Cause/Remedy
The water is not draining.	<ul style="list-style-type: none"> ■ Could the drain pump be blocked? → "Drain pump is blocked" on page 47 ■ Could the drain hose at the siphon be blocked? → "The drain hose at the siphon is blocked" on page 47
Water is not visible in the drum.	Not a fault – the water is below the visible area.
The spin result is not satisfactory. Laundry wet/too damp.	<ul style="list-style-type: none"> ■ Not a fault – the unbalanced load detection system has interrupted the spin cycle because the laundry is unevenly distributed. Distribute small and large items of laundry evenly in the drum. ■ Is Easy iron additional programme setting selected? (depending on the model) ■ Is Silent wash additional programme setting or Silent wash programme selected? (depending on the model) ■ Is the selected speed too low?
The spin cycle runs several times.	Not a fault – the unbalanced load detection system is adjusting an imbalance.
The programme is taking longer than usual.	<ul style="list-style-type: none"> ■ Not a fault – the unbalanced load detection system is adjusting an imbalance by repeatedly distributing the laundry. ■ Not a fault – the foam detection system is active – a rinse cycle has been switched on.
The length of the programme changes during the wash cycle.	Not a fault – the programme sequence is optimised for the specific washing process. This may change the length of the programme shown on the Touch-Display.
Foam may come out of the detergent drawer.	<p>Too much detergent used?</p> <p>Reduce the basic dosage of  i-Dos for the next washing cycle with the same load.</p> <p>Use commercially available low foam detergent and care product which are suitable for machine.</p>
Residual water in the left-hand compartment for the care product.	Not a fault – the effectiveness of the care product is not affected.
Odours, stain formation in the appliance.	<p>Run the  Drum Clean 90 °C programme without laundry.</p> <p>Add washing powder or a detergent containing bleach.</p> <p>Note: To prevent foaming, only use half the amount of detergent recommended by the detergent manufacturer. Do not use detergents designed for woollens or delicates.</p>
Repeated, intensive foaming.	<ul style="list-style-type: none"> ■ Check your basic dosage and dosage strength settings. ■ If required, use a different liquid detergent.

Faults	Cause/Remedy
I am unable to connect to my home network.	<ul style="list-style-type: none"> ■ Wi-Fi is switched off. To connect to your home network, switch on Wi-Fi.  must appear on the display. ■ Wi-Fi is switched on but a connection to your home network cannot be established. Check whether your home network is available or try to connect to your home network again.
Home Connect is not working.	<ul style="list-style-type: none"> ■ You can find solutions to problems with Home Connect at www.home-connect.com. ■ The availability of the Home Connect functionality depends on the availability of the Home Connect Services (e.g. provision of the app) in your country. Home Connect Services are not available in every country – for further information please check: www.home-connect.com.
Loud noises, vibrations and appliance "movement" during the spin cycle.	<ul style="list-style-type: none"> ■ Is the appliance aligned? → <i>"Alignment" on page 18</i> ■ Are the appliance's feet fixed? Secure the appliance's feet. ■ Have the transport locks been removed? → <i>"Removing the transport locks" on page 15</i>
The Touch-Display indicator lights do not work while the appliance is running.	<ul style="list-style-type: none"> ■ Has there been a power failure? ■ Have the fuses blown? Reset/replace the fuses. ■ If the fault occurs repeatedly, call customer services.
There is detergent residue on the laundry.	<ul style="list-style-type: none"> ■ Some phosphate-free detergents contain water-insoluble residue. ■ Select  Rinse or brush the laundry after washing.
<p>If you cannot rectify a fault yourself (after switching the appliance off and on again) or a repair is required:</p> <ul style="list-style-type: none"> ■ Switch off the appliance and pull out the mains plug. ■ Turn off the tap and call customer services. 	



After-sales service

If you cannot rectify a fault yourself, (→ *"Faults and what to do about them" on page 50*), please contact our after-sales service.

We will always find an appropriate solution to avoid unnecessary visits by engineers.

Please provide the after-sales service with the product number (E-Nr.) and the production number (FD) of the appliance.

E-Nr. _____	FD _____
-------------	----------

E-Nr.	Product number
FD	Production number

You can find this information (depending on the model):

- On the inside of the loading door
- On the back of the appliance

Trust the expertise of the manufacturer. Contact us. By doing so, you can be sure that the repairs are carried out by trained service personnel using genuine spare parts.



Technical data

Dimensions:

848 x 598 x 622 mm

(height x width x depth)

Weight:

78 kg

Mains connection:

Nominal voltage 220-240V, 50 Hz

Minimum installation protection (≡)10 A

Nominal power 1900-2300 W

Water pressure:

100–1000 kPa (1–10 bar)

Power consumption when switched off:

0,12 W

Power consumption when ready for use (left-on mode):

0,43 W

Power consumption when networked (Wi-Fi) in standby mode/duration:

0,9 W / 20 mins



Aqua-Stop warranty

Only for appliances with Aqua-Stop

In addition to warranty claims against the vendor based on the purchase agreement and to our appliance warranty, we will provide compensation under the following conditions:

1. If water damage is caused due to a fault in our Aqua-Stop system, we will compensate domestic customers for the damage caused.
2. The liability guarantee is valid for the service life of the appliance.
3. It is a prerequisite of all warranty claims that the appliance with Aqua-Stop must have been installed and connected correctly in accordance with our instructions; this also includes a correctly fitted Aqua-Stop extension (genuine accessories). Our warranty does not cover defective feed lines or fittings leading to the Aqua-Stop connection at the tap.
4. Appliances with Aqua-Stop do not need to be supervised during operation, nor secured afterwards by turning off the tap.
The tap only needs to be turned off if you are away from home for a long period, e.g. for several weeks' holiday.

Repair order and advice in the event of faults

GB 0344 892 8999 (Calls charged at local or mobile rate.)

IE 01450 2655 (0.03 € per minute at peak. Off peak 0.0088 € per minute.)

You can find the contact information for all countries in the attached after-sales service directory.

BSH Hausgeräte GmbH

Carl-Wery-Straße 34

81739 München

GERMANY

siemens-home.bsh-group.com

Manufactured by BSH Hausgeräte GmbH under Trademark License of Siemens AG



9001241913 (9802)