

Brief and handy: everything your dishwasher needs ...
 Before using for the first time, read the operating instructions!

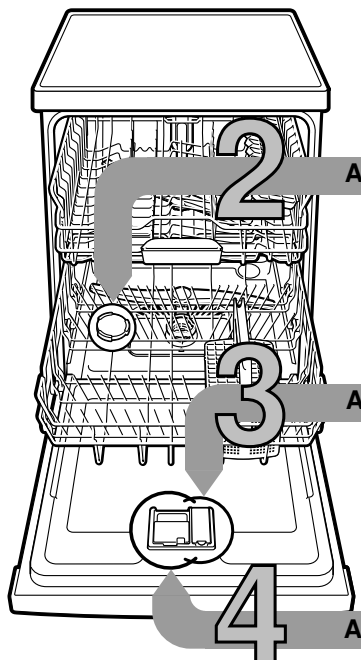

1

Adjusting the water softening system *

Ask your water supply company what the water hardness is and enter ...

Water hardness value Clarke	Hardness range	mmol/l	Factory setting
0-8	soft	0-1.1	H:00
9-10	soft	1.2-1.4	H:01
11-12	medium	1.5-1.8	H:02
13-15	medium	1.9-2.1	H:03
16-20	medium	2.2-2.9	H:04
21-26	hard	3.0-3.7	H:05
27-38	hard	3.8-5.4	H:06
39-62	hard	5.5-8.9	H:07

* only before the first wash or if the water hardness has changed

Quickly done ...

How to adjust

- Switch on the ON/OFF switch.
 Press and hold the **Setup 3 sec.** button for 3 seconds.
 In the display window you will see the factory setting H:04 and **set**.
 Adjust the setting using the buttons - and +.
 - Press and hold the **Setup 3 sec.** button for 3 seconds.
 The chosen setting has now been stored in your dishwasher.

Add special salt

Dissolves limescale (not necessary when set to 0!) ...

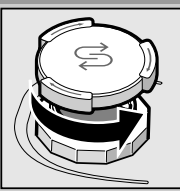

Open the lid.

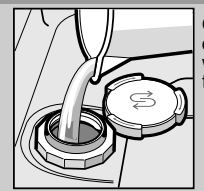

Only fill the salt dispenser with water before the first wash.

For optimal washing results

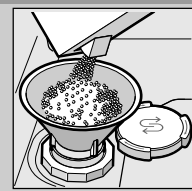

Add special salt (never use detergent!).

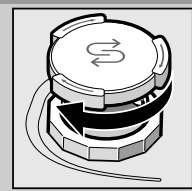

Close the lid. Rinse immediately.

Add rinse aid

Gets it sparkling clean ...

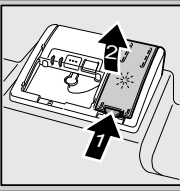

Press marking 1, lift lid 2.



For optimum drying results

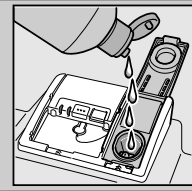

Add rinse aid.



Close lid. CLICK!

Add detergent

A lot of dirt, a lot of detergent ...



If required, open the cover (press button).



Attention: Combination products are not suitable for all programmes, follow manufacturer's instructions.

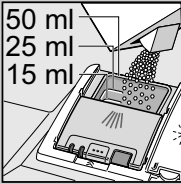

Pour detergent into the dry detergent dispenser only.



Slide cover shut, press. PLOP!

5

Switch on the appliance

6

Select a programme

Quick, economical or intensive ...

Overview of programmes

This overview describes all the possible programmes. You can see which programmes your appliance offers from its control panel. The values given in the programme details are laboratory measurements compliant with European standard EN 50242. The consumption figures depend on the selected programme and additional functions. The programme duration will be different if the machine is short of rinse additive or the function is turned off.

* half normal load

** Suitable programme for running at night: it takes longer, but is extremely quiet.

	Intensive 70°	Auto 45°/65°	Eco 50°	Silence ** 50°	Glass 40°	65°	Auto 35° / 45°	Quick 45°	Pre Rinse	Machine Care
Duration in hrs : mins.	2:05-2:15	1:30-2:40	3:15	4:00	1:25-1:30	1:00	1:05-1:20	0:29 *	0:15	1:30
Energy consumption in kWh	1,450-1,500	0,950-1,600	0,904	1,050-1,090	0,850-0,900	1,300	0,700-0,850	0,800	0,050	0,900-1,060
Water consumption in litres	12-15	7-18	9,2	10	11-14	10	10-15	10	4	9,5-12,5



Switch on the appliance. Here we go ...

7

8

Switch off the appliance Everything o.k. ...

You will find descriptions of possible additional functions in your instruction manual.

Maintenance and care

For perfect rinsing results ...

Cleaning waste water pump

Filters
... check, if required, clean.

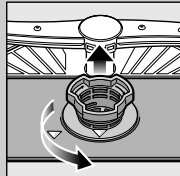

Rotate filter cylinder, remove filter system ...

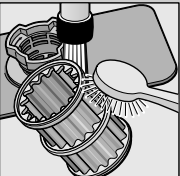

rinse under running water ...

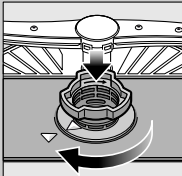

insert ...

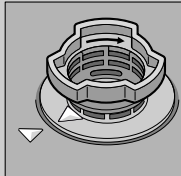

Screw on filter system
NOTE MARK!

- Pull out the mains plug.
- Remove filters and scoop out water.
- Lever off cover (A).
- Check area around the fan impeller for foreign objects.
- Click cover shut (B).
- Insert filters.

Spray arms
... Remove blockages/deposits.

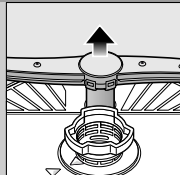

pull lower arm upwards ...



unscrew upper arm ...



clean spray nozzles under running water (if required use toothpicks) ...

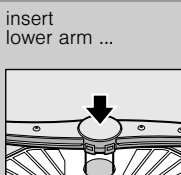

insert lower arm ...
screw on upper arm tightly

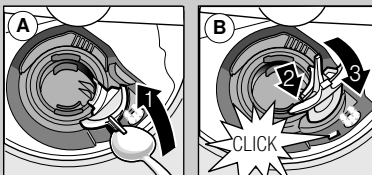

Rectifying minor faults yourself ...

... as it is worth doing it yourself!

More information can be found in the operating instructions

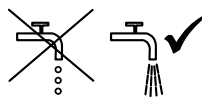
Fault	Possible causes	Remedial action
Display "E:18"/"🚰" is lit *	Supply fitting jammed or calcified 	<ul style="list-style-type: none"> ▶ Open supply fitting. ▶ 1. Unscrew water connection. ▶ 2. Clean filter in the water connection. ▶ 3. Flow rate must be min. 10 l/min., when water supply is open. If the flow rate is less, replace the supply fitting. ▶ Install supply hose without kinks.
Display "E:22"	Filters are soiled or blocked	▶ Clean the filters (see above).
Display "E:24" and "🚰" are lit*	Waste water hose is blocked or kinked Cover not attached to waste water pump	<ul style="list-style-type: none"> ▶ Install waste water hose without kinks. ▶ Attach cover (see above).
Display "E:25" and "🚰" are lit*	Waste water pump blocked	▶ Clean waste-water pump (see above).
Other fault display "E:XX" is lit	Appliance has technical defect	<ul style="list-style-type: none"> ▶ Call factory customer service (state fault display). ▶ Unplug appliance.
Residual water in the appliance	The programme has not yet ended	▶ Switch on and close the appliance or terminate the programme (see Terminating the programme).
Rust on the cutlery	Cutlery not rust-resistant Hard knife blades are more susceptible Extraneous rust	<ul style="list-style-type: none"> ▶ Use dishwasher-proof cutlery. ▶ Never wash rusting parts in the appliance.

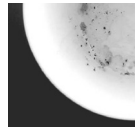
Fault	Possible causes	Remedial action
Utensils are not clean	Utensils are situated close together or one above the other	▶ Separate the utensils, prevent contact points.
Sand or gritty residue on the utensils 	Too little detergent	▶ Follow manufacturer's instructions (detergent).
	Unsuitable programme selected	▶ Select a more intensive programme.
	Spray arm nozzles blocked	▶ Clean the spray arms (see above).
	Filters dirty, not seated firmly	▶ Clean the filters (see above).
Spray arms blocked		▶ Arrange the utensils so that the spray arms can rotate freely.
Stains and streaks	Rinse aid dosage too high/too low	<ul style="list-style-type: none"> ▶ Streaks: reduce dosage. ▶ Water or limescale stains: increase dosage.
Utensils not dry	Rinse aid	<ul style="list-style-type: none"> ▶ Increase dosage. ▶ Change the product.
	The combined detergent used has a poor drying performance	▶ Use rinse aid.
	Appliance setting	▶ Activate intensive drying (depending on model).
Milky deposits on the utensils (can be removed)	Water softening system incorrectly set	▶ Correctly set water softening system.
	No salt	▶ Refill with special salt.
Milky deposits, glasses cloudy/tarnished (cannot be removed)	Glasses not dishwasher-proof	▶ Use dishwasher-proof glasses.
		▶ Use a detergent suitable for glasses.
Plastic/utensils discoloured	Too little detergent	▶ Follow manufacturer's instructions (detergent).
	Discoloration caused by food colourings (tomato sauce)	▶ Discoloration is harmless; subsequent rinse cycles will cause it to fade.

* depending on model

Terminating the programme ...

Loading the dishwasher correctly ...

Press the start button and hold for 3 seconds (Reset).



The display window shows: Program was terminated.



The programme sequence lasts approx. 1 min.
The display window shows: Finished.
Switch off ON/OFF switch.

Dishwasher-proof utensils (not soiled with ash, wax, lubricating grease, ink or adhesive labels; remove large remnants of jam, milk products and food according to the operating instructions and check that the spray arms can rotate freely.