



Register your new Bosch now:
www.bosch-home.com/welcome



Tumble dryer
WTWH7560GB



BOSCH

en Installation and operating instructions

Your new tumble dryer

You have opted for a tumble dryer manufactured by Bosch.

Please take a few minutes to read and become familiar with the advantages of your tumble dryer.

To meet the high quality demands required by Bosch, every tumble dryer that leaves our factory is carefully checked to ensure that it functions correctly and is in perfect condition.

For more information on our products, accessories, replacement parts and services, see our website www.bosch-home.com or contact our Customer Service centres.

If the operating and installation instructions describe different models, any differences will be pointed out at the relevant points in the text.



Read these operating and installation instructions before operating the tumble dryer.

Display rules

Warning!

This combination of symbol and signal word indicates a possibly dangerous situation. Not heeding the warning can cause death or injuries.

Caution!

This signal word indicates a possibly dangerous situation. Not heeding the caution can cause property and/or environmental damage.

Note/tip

Information about the optimum use of the appliance/any other useful information.

1. 2. 3. / a) b) c)



The steps are represented by numbers or letters.

■ / -

Lists are represented by a small box or a dash.

Table of contents

 Intended use	4	Setting a programme	28
 Safety instructions	5	Starting a programme	28
Children/people/pets	5	Programme progress	29
Installation	6	Changing the programme or adding more laundry	29
Operation	8	Cancelling the programme	29
Cleaning/Maintenance	10	Programme end	29
 Energy-saving tips	12	Removing laundry and switching off the appliance	29
 Installing and connecting the appliance	12	Emptying the condensation container	30
Included with the appliance:	12	Removing the fluff	30
Installing the appliance	13	 Home Connect	32
Connecting the appliance	14	Connecting to your home network automatically	33
Before using the appliance for the first time	15	Connecting to your home network manually	33
Optional accessories	15	Connecting to the Home Connect app	34
 Appliance settings	16	Switching Wi-Fi on and off	35
Childproof lock	16	Resetting your network settings	36
Activating setting mode	16	Updating the software	36
Exiting setting mode	17	Information on data protection	37
 Quick reference guide	18	Declaration of Conformity	37
 Familiarising yourself with your appliance	19	 Replacing the condensation drain	38
Appliance overview	19	 Cleaning and maintenance	41
Panel	20	Cleaning the appliance	41
Display	21	Cleaning the moisture sensor	41
 Overview of programmes	22	Cleaning the filter in the condensation container	42
 Programme settings	24	 Information on the display	43
 Laundry	26	 Help with the appliance	44
Preparing the laundry	26	 Transporting the appliance	46
Sorting laundry	26	 Consumption values	48
 Operating the appliance	27	Consumption values table	48
Loading laundry and switching on the appliance	27	Most efficient programme for cotton laundry	48

	Technical specifications	49
	Disposal.	49
	After-sales service	50

Intended use

- This appliance is intended for private domestic use only.
- Do not install or operate this appliance anywhere that is liable to experience frost and/or outdoor conditions. There is a risk that the appliance will be damaged if residual water in it freezes. If hoses freeze up, they may crack/burst.
- This appliance must only be used for drying and freshening up domestic laundry, consisting of items that have been washed with water and are suitable for tumble drying (see label on item). Using the appliance for any other purpose is outside of the scope of its intended application and is forbidden.
- This appliance is intended for use up to a maximum height of 4000 metres above sea level.

Before you switch on the appliance:

Check that there is no visible damage to the appliance. Do not operate the appliance if it is damaged. Should you have any problems, please contact your specialist dealer or our customer service.

Read and follow the operating and installation instructions and all other information provided with this appliance.

Retain the documents for subsequent use or for subsequent owners.

Safety instructions

The following safety information and warnings are provided to protect you from injury and to prevent material damage to your surroundings.

It is nevertheless important to take the necessary precautions and to proceed with care when installing, maintaining, cleaning and operating the appliance.

Children/people/pets

Warning **Risk of death!**

Children and other people who are unable to assess the risks involved when using the appliance may injure themselves or may find themselves in life-threatening situations. Therefore please note:

- The appliance may be used by children over the age of 8 years and by persons with reduced physical, sensory or mental capacity or by persons with a lack of experience or knowledge as long as they are supervised or have received instruction on how to use the appliance safely and they have understood the potential risks of using the appliance.
- Children must not play with this appliance.

- Do not allow children to clean or maintain this appliance unsupervised.
- Keep children under 3 years and pets away from this appliance.
- Do not leave the appliance unattended when children or other people who are unable to assess the risks are in the vicinity.

Warning **Risk of death!**

Children may lock themselves inside appliances and find themselves in a life-threatening situation.

- Do not position the appliance behind a door, as this may obstruct the appliance door or prevent it from opening completely.
- Once an appliance has reached the end of its life, pull the mains plug from the socket **before** severing the mains cable, and then destroy the lock on the appliance door.

⚠ Warning

Risk of suffocation!

If allowed to play with the packaging/plastic film or packing components, children may become caught in these or pull them over their heads and suffocate.

Keep packaging, plastic film and packing components away from children.

⚠ Warning

Risk of poisoning!

Detergents and care products may result in poisoning if consumed.

If accidentally swallowed, seek medical advice. Keep detergents and care products out of the reach of children.

⚠ Warning

Eye/skin irritation!

Contact with detergents or care products may cause eye/skin irritation.

Rinse eyes/skin thoroughly if they/it come(s) into contact with detergents or care products. Keep detergents and care products out of the reach of children.

Installation

⚠ Warning

**Risk of electric shock/fire/
material damage/damage to
the appliance!**

If the appliance is not installed properly, this may lead to a dangerous situation. Make sure that:

- The mains voltage on your power socket matches the rated voltage specified on the appliance (identification plate). The connected loads and the required fuse protection are specified on the identification plate.
- The appliance is only connected to a source of alternating current via a nationally recognized and grounded outlet that has been correctly installed.
- The mains plug and the grounded socket match and the earthing system has been correctly installed.
- The cross section of the cable is sufficiently large enough.
- The mains plug is accessible at all times.
- If using a residual current circuit breaker, only use one that bears the following mark: . The presence of this mark is the only way to be sure that it fulfils all the applicable regulations.

⚠ Warning**Risk of electric shock/fire/
material damage/damage to
the appliance!**

If the appliance's mains cable is altered or damaged, this may result in electric shock, short circuiting or fire due to overheating.

The mains cable must not be kinked, crushed or altered, and must not come into contact with any heat sources.

⚠ Warning**Risk of fire/material damage/
damage to the appliance!**

The use of extension cords or power strips may result in fire due to overheating or short circuiting.

Connect the appliance directly to an earthed socket that has been correctly installed. Do not use extension cords, power strips or multi-way couplers.

⚠ Warning**Risk of injury/material
damage/damage to the
appliance!**

- The appliance may vibrate or move when in operation, potentially resulting in injury or material damage. Place the appliance on a clean, even, solid surface and, using a spirit level to guide you, level it with the screw-in feet.

- Incorrectly placing (stacking) this appliance on top of a washing machine may result in injury, material damage and/or damage to the appliance.

If this appliance is to be placed on top of a washing machine, the washing machine must be of at least the same depth and width as the appliance, and it must be secured in place with the appropriate connection set if available. → *Page 15* The appliance **MUST** be secured with this connection set. Stacking the appliance in any other way is forbidden.

- If you take hold of any of the appliance's protruding parts (e.g. the appliance door) in order to lift or move it, these parts may break off and cause injury. Do not take hold of any of the appliance's protruding parts in order to move the appliance.

⚠ Warning**Risk of injury!**

- The appliance is very heavy. Lifting it may result in injury. Do not lift the appliance on your own.

- The appliance has sharp edges on which you could cut your hands. Do not take hold of the appliance by its sharp edges. Wear protective gloves to lift it.
- If the hoses and mains cables are not correctly routed, they may constitute a tripping hazard, which may result in injury. Route hoses and cables such that they do not constitute a tripping hazard.

Operation

Warning **Risk of explosions/fire!**

Laundry that has come into contact with solvents, oil, wax, wax remover, paint, grease or stain remover may ignite when dried in the machine, or even cause the appliance to explode. Therefore please note:

- Rinse the laundry thoroughly with warm water and detergent before drying it in the machine.
- Do not place laundry in this appliance to be dried if the laundry has not been washed first.
- Do not use the appliance if industrial chemicals have been used to clean the laundry.

Warning **Risk of explosions/fire!**

- If there is any residual material left in the fluff filter, this may ignite when drying is in progress, or even cause the appliance to catch fire or explode. Clean out the fluff filter each time the appliance is used to dry laundry.
- Certain objects may ignite when drying is in progress, or even cause the appliance to catch fire or explode. Remove any lighters or matches from pockets on items of clothing.
- If there is coal dust or flour in the air around the appliance, this may cause an explosion. Make sure that the area around the appliance is kept clean when it is in operation.

Warning **Risk of fire/material damage/ damage to the appliance!**

If a program is terminated before the drying cycle has finished, this prevents the laundry from cooling down sufficiently and may cause the laundry to ignite, or may result in material damage or damage to the appliance.

- During the last part of the drying cycle, the laundry in the drum is not heated (cooling cycle). This is to ensure that it remains at a temperature at which it will not be damaged.
- Do not switch off the appliance before the drying cycle has finished unless you remove all items of laundry from the drum immediately and spread them out (to dissipate the heat).

Warning

Risk of poisoning/material damage!

Condensation water is not suitable for drinking and may be contaminated with lint. Contaminated condensation water may be hazardous to health and may cause material damage.

Do not drink or reuse.

Warning

Risk of poisoning!

Poisonous fumes may be given off by cleaning agents that contain solvents, e.g. cleaning solvent.

Do not use cleaning agents that contain solvents.

Warning **Risk of injury!**

- If you support your weight/sit on the appliance door when it is open, the appliance may tip over, which may result in injury.
Do not support your weight on the appliance door when it is open.
- If you climb onto the appliance, the worktop may break, which may result in injury.
Do not climb onto the appliance.
- If you reach into the drum while it is still rotating, you risk injuring your hands.
Wait until the drum has stopped rotating.

Caution!

Material damage/damage to the appliance

- If the amount of laundry in the appliance exceeds its maximum load capacity, it may not be able to operate properly, or this may result in material damage or damage to the appliance.
Do not exceed the maximum load capacity of dry laundry. Make sure you comply with the maximum load capacities specified for each of the programs. → *Page 22*

- If you operate the appliance without a fluff filter, or if the fluff filter is defective, this may result in damage to the appliance.
Do not operate the appliance without a fluff filter, or with a fluff filter that is defective.
- Light objects such as hair and lint may be sucked into the air inlet when the appliance is in operation. Keep these away from the appliance.
- Foam and foam rubber may deform or melt if dried in the appliance.
Do not dry laundry items that contain foam or foam rubber in the appliance.
- If you pour the wrong quantity of detergent or cleaning agent into the appliance, this may result in material damage or damage to the appliance.
Use detergents/care products/cleaning agents and softeners in accordance with the manufacturers' instructions.

- If the appliance overheats, it may not be able to operate properly, or this may result in material damage or damage to the appliance.
Make sure that the appliance's air inlet is never obstructed when the appliance is in operation, and that the area around the appliance is adequately ventilated.

Cleaning/Maintenance

Warning **Risk of death!**

The appliance is powered by electricity. There is a risk of electric shock if you come into contact with live components. Therefore please note:

- Switch off the appliance. Disconnect the appliance from the power supply (pull out the plug).
- Never take hold of the mains plug with wet hands.
- When removing the mains plug from the socket, always take hold of the plug itself and never the mains cable, otherwise this may damage the mains cable.
- Do not make any technical modifications to the appliance or its features.

- Repairs and any other work on the appliance must only be conducted by our customer service or by an electrician. The same applies for replacing the mains cable (when necessary).
- Spare mains cables can be ordered from our customer service.

⚠ Warning
Risk of poisoning!

Poisonous fumes may be given off by cleaning agents that contain solvents, e.g. cleaning solvent.

Do not use cleaning agents that contain solvents.

⚠ Warning
Risk of electric shock/material damage/damage to the appliance!

If moisture penetrates the appliance, this may cause it to short circuit.

Do not use a pressure washer or steam cleaner to clean your appliance.

⚠ Warning
Risk of injury/material damage/damage to the appliance!

The use of spare parts and accessories supplied by other brands is dangerous and may result in injury, material damage or damage to the appliance.

For safety reasons, use genuine spare parts and accessories only.

Caution!
Material damage/damage to the appliance

Cleaning agents and agents for pretreating laundry (e.g. stain removers, prewash sprays, etc.) may cause damage if they come into contact with the surfaces of the appliance. Therefore please note:

- Do not allow these agents to come into contact with the surfaces of the appliance.
- Clean the appliance with nothing but water and a soft, damp cloth.
- Remove any detergent, spray or other residues immediately.

Energy-saving tips

- Spin the laundry before drying. The drier the laundry, the shorter the programme will be, in turn reducing energy consumption.
- Load the appliance with the maximum loads permitted for the programmes.

Note: If the maximum load is exceeded, this extends the programme duration and increases energy consumption.

- Operate the appliance in a ventilated room and make sure that the air inlet on the appliance is unobstructed so that air exchange can take place unhindered.
- Regularly remove the fluff from the appliance. If there is fluff in the appliance, this extends the programme duration and increases energy consumption.
- If you do not perform any actions on the appliance for an extended period before the programme starts or once the programme has ended, the appliance will automatically switch to Energy saving mode. The display and indicator lights will go out after a few minutes and **Start/Pause**  will flash. To end Energy saving mode, all you need to do is perform an action on the appliance, such as opening and closing the door.
- If you do not perform any actions on the appliance for an extended period when it is in Energy saving mode, the appliance will automatically switch itself off.

Note: If Wi-Fi is switched on on the appliance, when it is in Energy saving mode, the appliance will not automatically switch itself off.

Installing and connecting the appliance

Included with the appliance:

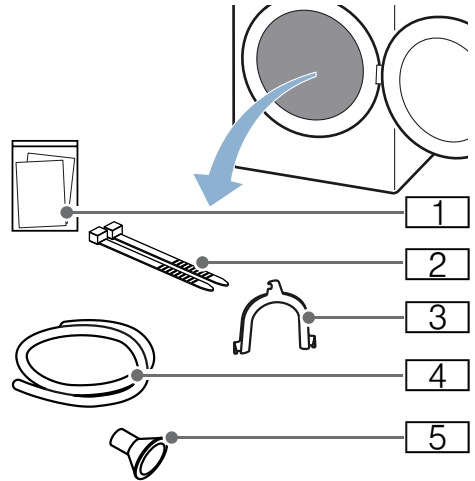

- 1 Accompanying documents (e.g. installation and operating instructions)
- 2 Fastening parts
- 3 U-piece for fixing the drain hose in place
- 4 Drain hose
- 5 Connection adapter

1. Remove any packaging and protective covers completely from the appliance.
2. Open the door.
3. Remove all the accessories from the drum.

You can now install and connect the appliance.

Caution!**Risk of material damage/damage to the appliance**

Objects remaining in the drum that are not designed for operation with the appliance may result in material damage and damage to the appliance. Remove these objects, along with all accessories, from the drum.

Installing the appliance

 **Warning**
Risk of death!

Children may lock themselves inside appliances and find themselves in a life-threatening situation.

- Do not position the appliance behind a door, as this may obstruct the appliance door or prevent it from opening completely.
- Once an appliance has reached the end of its life, pull the mains plug from the socket **before** severing the mains cable, and then destroy the lock on the appliance door.

 **Warning**
Risk of explosions/fire!

If there is coal dust or flour in the air around the appliance, this may cause an explosion. Make sure that the area around the appliance is kept clean when it is in operation.

 **Warning**
Risk of injury/material damage/damage to the appliance!

- The appliance may vibrate or move when in operation, potentially resulting in injury or material damage. Place the appliance on a clean, even, solid surface and, using a spirit level to guide you, level it with the screw-in feet.

- Incorrectly placing (stacking) this appliance on top of a washing machine may result in injury, material damage and/or damage to the appliance.

If this appliance is to be placed on top of a washing machine, the washing machine must be of at least the same depth and width as the appliance, and it must be secured in place with the appropriate connection set if available.

→ *Page 15* The appliance **MUST** be secured with this connection set.

- Stacking the appliance in any other way is forbidden.
- If you take hold of any of the appliance's protruding parts (e.g. the appliance door) in order to lift or move it, these parts may break off and cause injury. Do not take hold of any of the appliance's protruding parts in order to move the appliance.

 **Warning**
Risk of injury!

- The appliance is very heavy. Lifting it may result in injury. Do not lift the appliance on your own.
- The appliance has sharp edges on which you could cut your hands. Do not take hold of the appliance by its sharp edges. Wear protective gloves to lift it.

Caution!
Material damage/damage to the appliance

If the appliance overheats, it may not be able to operate properly, or this may result in material damage or damage to the appliance.

Make sure that the appliance's air inlet is never obstructed when the appliance is in operation, and that the area around the appliance is adequately ventilated.

Install the appliance as follows:

1. Place the appliance on a clean, even, solid surface.
2. Check that the appliance is level using a spirit level.

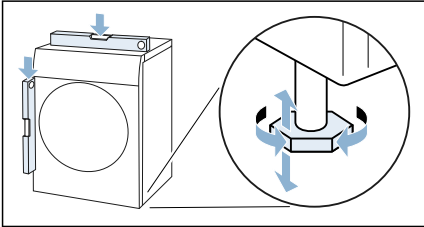

3. If necessary, turn the appliance feet to make sure it is level.

You can now connect the appliance.

Notes

- All appliance feet must stand firmly on the ground.
- If appliances are not installed correctly, this may result in noises, vibrations, uneven drum operation and/or to residual water leaking out of the appliance.

Connecting the appliance

Warning

Risk of electric shock/fire/material damage/damage to the appliance!

If the appliance is not installed properly, this may lead to a dangerous situation. Make sure that:

- The mains voltage on your power socket matches the rated voltage specified on the appliance (identification plate). The connected loads and the required fuse protection are specified on the identification plate.

- The appliance is only connected to a source of alternating current via a nationally recognized and grounded outlet that has been correctly installed.
- The mains plug and the grounded socket match and the earthing system has been correctly installed.
- The cross section of the cable is sufficiently large enough.
- The mains plug is accessible at all times.
- If using a residual current circuit breaker, only use one that bears the following mark: . The presence of this mark is the only way to be sure that it fulfils all the applicable regulations.

Warning

Risk of electric shock/fire/material damage/damage to the appliance!

If the appliance's mains cable is altered or damaged, this may result in electric shock, short circuiting or fire due to overheating.

The mains cable must not be kinked, crushed or altered, and must not come into contact with any heat sources.

Warning

Risk of fire/material damage/damage to the appliance!

The use of extension cords or power strips may result in fire due to overheating or short circuiting. Connect the appliance directly to an earthed socket that has been correctly installed. Do not use extension cords, power strips or multi-way couplers.

Warning

Risk of injury!

If the hoses and mains cables are not correctly routed, they may constitute a tripping hazard, which may result in injury.

Route hoses and cables such that they do not constitute a tripping hazard.

Connect the appliance as follows:

1. You can change the condensation drain if you wish. → *Page 38*

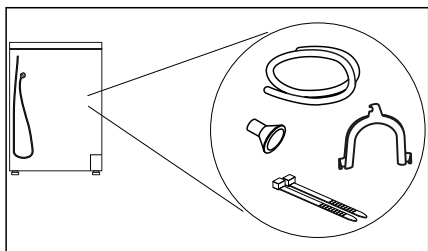

2. Plug the appliance's mains plug into the designated socket.
3. Check that the mains plug is in securely.

Your appliance is now ready to use.

Note: If in doubt, have your appliance connected by a qualified professional.

Before using the appliance for the first time**Before you switch on the appliance:**

Check that there is no visible damage to the appliance. Do not operate the appliance if it is damaged. Should you have any problems, please contact your specialist dealer or our customer service.

Note: Once the appliance has been properly installed and connected, it is ready to use. No further steps are necessary.

Optional accessories

Order optional accessories* from the after-sales service:

- **Basket for woollens:**
Dry or air individual woollen items, sports shoes and soft toys in the basket for woollens.
– Order number: **WMZ20600**.
- **Platform:**
For easier loading and unloading, raise your dryer with a platform. You can transport laundry with the laundry basket integrated into the platform drawer.
– Order number: **WMZ20500**.
- **Washer-dryer stack connection kit:**
To save space, the dryer can be placed on top of a suitable washing machine of the same width and depth.
Only this connection kit may be used to secure the dryer to the washing machine.
– Order number with pull-out worktop: **WTZ11400**
– Order number without pull-out worktop: **WTZ20410**.

* Depending on the appliance features



Appliance settings

Childproof lock

Activating the childproof lock prevents the settings from being accidentally changed on the control panel.

Activating/deactivating the childproof lock:

- Press and hold **Child lock push 3 sec.** for 3 seconds.

Note: The childproof lock will remain active, even once the appliance has been switched off. If you wish to change settings on the control panel when you turn on the appliance, you will need to deactivate the childproof lock.

Activating setting mode

In order to apply the settings described below, you will first need to activate setting mode. The options on the programme selector that will allow you to do this are as follows:

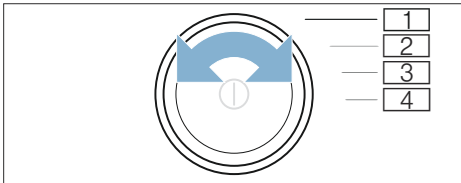

- 1 Activate **setting mode**
- 2 Activate **setting mode** and adjust **audible notification signal** volume
- 3 Adjust the **audible button signal** volume
- 4 **Automatic switch-off** function

1. Switch on the appliance.

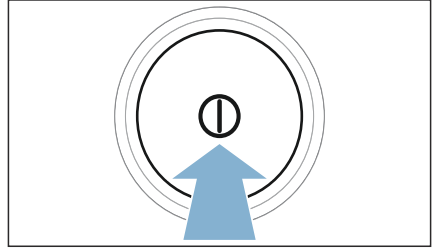

2. Turn the programme selector to position 1.
3. Press **Fine adjust** and, at the same time, turn the programme selector to position 2.
4. Release **Fine adjust**.
Setting mode is now activated.

Changing the audible signal volume

You can adjust the volume of audible notification signals (that indicate that a programme has ended, for example) and audible button signals by turning the rotary selector to the following positions:

- 2: Audible notification signal volume
 - 3: Audible button signal volume
1. Activate setting mode.
 2. Turn the programme selector to the required position.
 3. Use the **Finished in +** or **-** button to set the volume you require (0 = off; 4 = very loud).

Switching the automatic switch-off function on/off

If the appliance is not used for an extended period, it may automatically switch itself off until a programme starts or when a programme has ended in order to save energy. It can be switched back on again at any time by pressing ①.

You can switch the appliance's automatic switch-off function on or off as follows:

1. Activate setting mode.
2. Turn the programme selector to position 4.
3. Use the **Finished in +** or **-** button to switch the appliance's automatic switch-off function on or off.

Note: If Wi-Fi is switched on on the appliance, when it is in Energy saving mode, the appliance will not automatically switch itself off.

Exiting setting mode

Once you have applied all the settings, press ① to switch off the appliance.



The settings you have selected will be saved and will take effect the next time the washing machine is switched on.



Quick reference guide

1

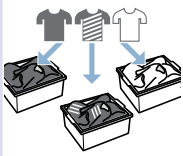
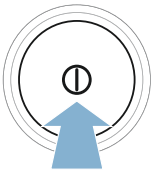
Before starting the programme:



⇒  ⇒  ⇒ 

Sort the laundry.

Switch on the appliance.

Select a programme.

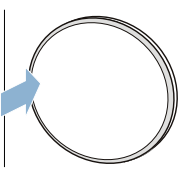
2

 ⇒  ⇒  ⇒ 

Open the door and place the laundry in the drum.

Close the door.

If necessary: Adjust the programme settings.

Start the programme.

3

Once the programme has ended:

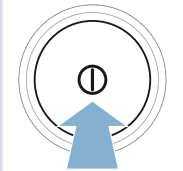
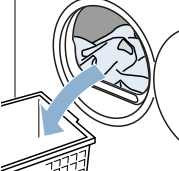
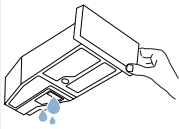
⇒  ⇒  ⇒ 

Switch off the appliance.

Open the door and remove the laundry.

Empty the condensation container.

4

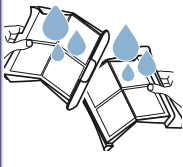

Remove the fluff.

Familiarising yourself with your appliance

Appliance overview

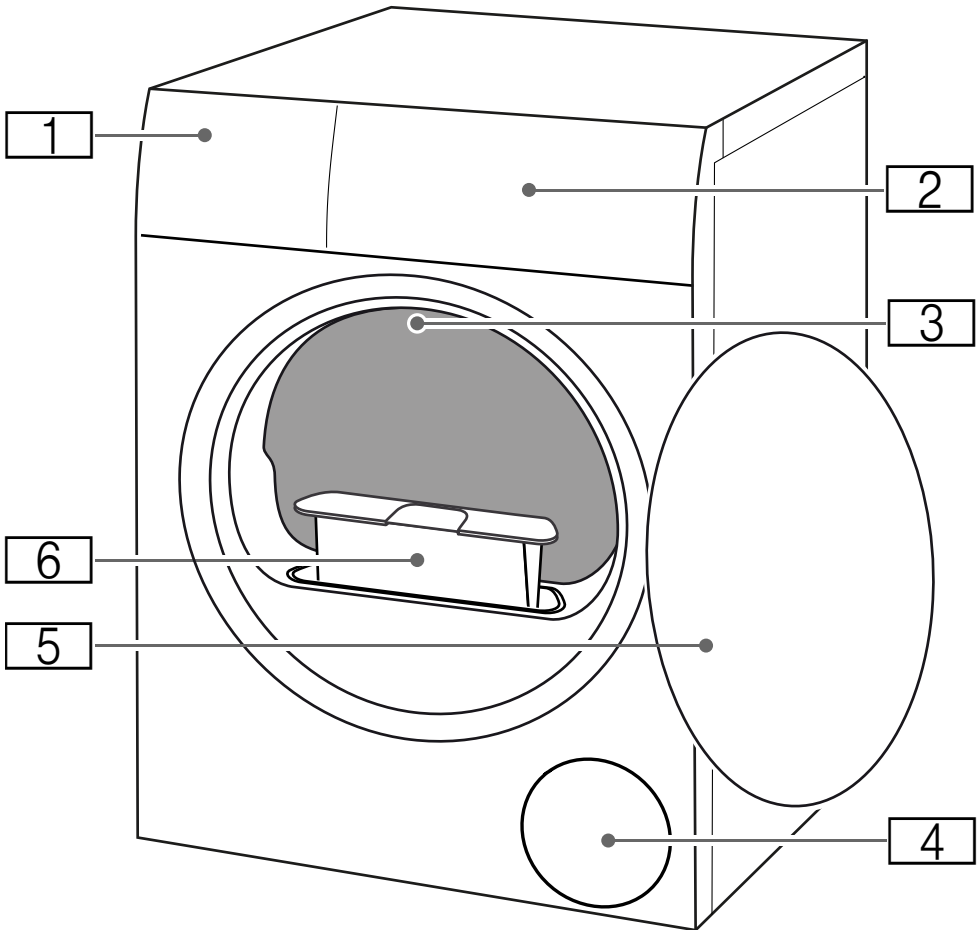

- 1** Condensation container
- 2** Control panel
- 3** Drum interior lighting (depending on the model)
- 4** Air inlet
- 5** Door
- 6** Fluff filter

Panel

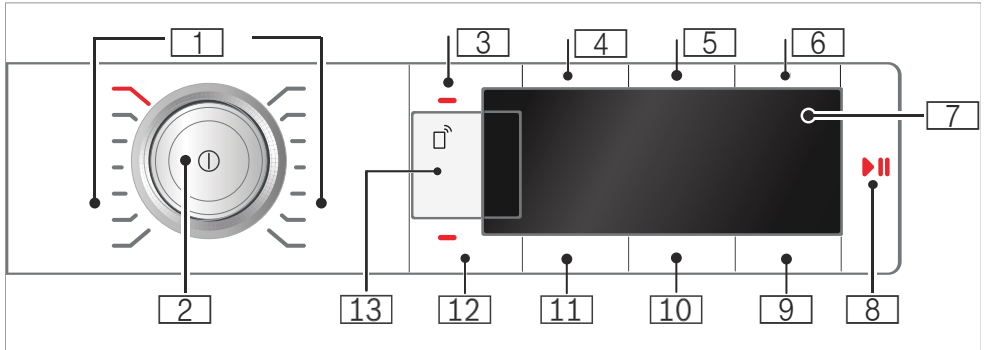

1 **Programmes** → Page 22

- 2 **Programme selector**
- Press to switch the appliance on/off
 - Turn to set a programme

3 **Childproof lock**
Prevents the functions you have set from being changed accidentally.
To activate/deactivate it: → Page 16

4 **Anti-Crease 60 min**

5 **Anti-Crease 120 min**

6 **Low-Heat Drying**

7 **Display**

Displays settings and information

- 8 **▶|| for:**
- Starting a programme
 - Pausing a programme, e.g. to add items of laundry
 - Cancelling a programme

9 **Ready in**

10 **Degree of dryness**









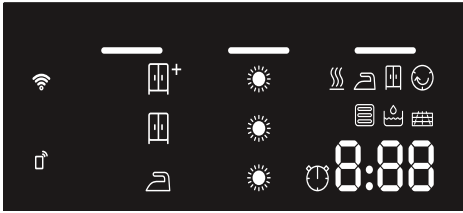









11 **Dryness level**

12 **Audible signal**

13 **Remote start** and **Home Connect settings** → Page 32

Display









-  **Empty the condensation container** → *Page 30*
-  **Remove the fluff**
→ *Page 30*
-  The **heat exchanger** is being cleaned automatically
-  **Programme progress** for:
Drying
-  Iron Dry
-  Cupboard Dry
-  Anti-Crease
-  - P -
-  - E -
-  **Dryness levels** for:
Iron Dry
-  Cupboard Dry
-  Cupboard Dry Plus
-  **Degree of dryness** selected
-  **Remote start** selected
-  **Off:** Wi-Fi is switched off and the appliance is not connected to your home network
-  **Flashing:** The appliance is trying to connect to your home network
-  **Lit:** Wi-Fi is switched on and the appliance is connected to your home network
-  **Timed programme** selected
- 1:27** Expected **programme duration** in hours and minutes
- 3h** **Programme delay** in hours when "Ready in" time is selected

Overview of programmes

Programme	Maximum load
Programme name Brief explanation of the programme and the items for which it is suitable.	Maximum load based on the dry weight of the items
 Cottons Hard-wearing items and heat-resistant items made of cotton or linen.	9 kg
Easy-Care Items made of synthetic or blended fabrics.	3.5 kg
Mixed Load Mixed load consisting of items made from cotton and synthetic fabrics.	3 kg
Delicates Delicate, washable items, e.g. made from satin, or synthetic or blended fabrics.	2 kg
Wool Finish Machine-washable items made of wool or containing wool.	0.5 kg
Notes <ul style="list-style-type: none"> ■ Laundry becomes fluffier but not dry. ■ Remove laundry once the programme has ended and allow to dry. 	
Timed Progr. Cold Timed programme for all types of fabric except for wool and silk. For freshening up or airing clothing that has hardly been worn. Note: You can adjust the programme duration. → "Programme settings" on page 24	3 kg
Timed Progr. Warm Timed programme for all types of fabric except silk. Suitable for pre-dried or slightly damp laundry and for drying off multi-layered, thick laundry. Notes <ul style="list-style-type: none"> ■ Dry woollens, sports shoes and soft toys only with the basket for woollens. ■ In the timed programme, the laundry's remaining moisture is not automatically detected. If the laundry is still too damp when the drying programme has ended, repeat the programme and, if required, extend the programme duration. → "Programme settings" on page 24 	3 kg Max. load for woollens/soft toys in the basket: 1 basket load Max. load for shoes in the basket: 1 pair
Shirts Shirts/blouses made of cotton, linen, or synthetic or blended fabrics. Note: Once the laundry is dry, iron it or hang it up. This will allow the residual moisture to be distributed evenly.	1.5 kg

Duvet	2.5 kg
Clothing, pillows, quilts or bedspreads filled with synthetic fibres.	
Note: Dry large items individually. Follow the instructions on the care label.	
Down Wear	1.5 kg
Clothing, pillows, bedspreads or eiderdowns filled with down.	
Note: Dry large items individually.	
Sportswear	1.5 kg
Weatherproof and outdoor clothing with a membrane coating and water-repellent fabrics.	
Towels	6 kg
Hard-wearing towels and dressing gowns made of cotton.	
Super Quick 40'	2 kg
Synthetic fabrics and light cottons.	
Allergy+	4 kg
Hard-wearing items.	
Note: Particularly suitable for strict hygiene requirements.	

P+ Programme settings

Buttons	Displays	Explanations and information
Note: Not all buttons and their functions can be selected in all programmes.		
Remote Start 		<p>Pressing Remote Start  enables the appliance to be started remotely via the Home Connect app and takes you to the Home Connect settings.</p> <p>Pressing this button briefly enables the appliance to be started remotely via the Home Connect app. Remote start remains enabled for 24 hours after it has been activated. It is automatically deactivated if you do not start the programme via the Home Connect app during this time. If you carry out any operations on the appliance itself, such as opening the door or selecting a different programme, the remote start button will be deactivated for safety reasons.</p> <p>Notes</p> <ul style="list-style-type: none"> ■ Remote start can only be activated if the appliance door is closed. ■ Remote start cannot be activated if the childproof lock is on. <p>Press and hold this button for at least 3 seconds to go to the Home Connect settings → <i>Page 32</i>.</p>
Reduced Ironing 60 min. Reduced Ironing 120 min.		The drum moves the laundry at regular intervals after drying to prevent creasing. You can extend the automatic Anti-Crease function by 60 minutes (by pressing Reduced Ironing 60 min.) or 120 minutes (by pressing Reduced Ironing 120 min.) after any programme has finished.
Low Heat		Reduced temperature for delicate fabrics, e.g. polyacrylic or elastane; may increase the drying time.
End Signal		Use the End Signal button to activate or deactivate the audible signal that sounds to indicate that the programme has ended. If the setting has been selected, the button's indicator light will be lit and the signal tone is activated.
Drying target 		<p>Select the dryness level depending on the required degree of dryness.</p> <p>If you have selected a dryness level, this will be stored for the selected programme even after the appliance has been switched off. Exception: The settings will not be saved for Cottons.</p>
Cupboard Dry Plus		Multi-layered, thick laundry that does not dry readily.
Cupboard Dry		Normal, single-layered laundry.
Iron Dry		Normal, single-layered laundry that still needs to be damp after drying and is suitable for ironing or hanging up.

Fine adjust



If you think the laundry is still too damp when the drying programme has ended, you can adjust the degree of dryness to achieve a particular dryness level. To increase the dryness level, set the degree of dryness to between ☀️ and ☀️☀️☀️. This will extend the programme duration but the temperature will remain the same.

Once you have adjusted the degree of dryness for a programme, this setting will be retained for the programme even after the appliance has been switched off.

Finished in

1-24

Before starting the programme, you can preselect the programme end time ("Ready in" time) in hourly increments (h = hour), up to a maximum of 24 hours:

1. Select a programme.
The programme duration will be displayed for the selected programme, e.g. 1:45 (hours:minutes).
2. Press **Finished in** repeatedly until the required number of hours is displayed.

Note: Use the **Finished in +** button to increase the setting values, and the **Finished in -** button to reduce them.

3. Press **Start/Pause** ▷|||.
This activates the time delay.
Before the programme starts, the selected number of hours (e.g. 3) is shown on the display and counts down until the drying programme starts. The duration of the programme will then be displayed.

Note: The programme duration is included in the "Ready in" time.

E.g.
🕒 0:40

The drying time for **timed programmes** can be extended to up to 3 hours 30 minutes in 10-minute increments.



Laundry

Preparing the laundry



Warning

Risk of explosions/fire!

Certain objects may ignite when drying is in progress, or even cause the appliance to catch fire or explode. Remove any lighters or matches from pockets on items of clothing.

Caution!

Risk of damage to the drum and laundry

Leaving objects in the pockets of your clothing can cause damage to the drum and laundry when the appliance is in operation. Remove all objects (e.g. metal items) from clothing pockets.

Prepare the laundry as follows:

- Tie cloth belts, apron strings, etc. together or use a laundry bag.
- Always dry very small items of laundry, e.g. babies' socks, together with large items such as towels.
- Use timed programmes for single items.
- Knitted items, such as T-shirts and jerseys, often shrink slightly the first time they are tumble-dried. Use a gentle programme.
- Do not overdry easy-care laundry. This leads to increased creasing of your laundry.
- Some detergents and care products, e.g. starch or softeners, contain particles that may accumulate on the moisture sensor. This may impair the sensor's performance and, in turn, the drying result.

Notes

- When washing laundry to be tumble-dried, use the correct amount of detergent and care products as specified in the manufacturer's instructions.
- Clean the moisture sensor regularly → *Page 41*.

Sorting laundry

Note: Load the laundry item by item into the appliance. For more effective drying, do not stuff an entire bundle of laundry into the dryer at once.

Caution!

Risk of material damage to the dryer or laundry

Laundry that is unsuitable for tumble-drying may damage the appliance and the laundry when it is dried. Before you dry it, sort the laundry according to the information given on the care label:

- Suitable for tumble drying
- Dry at normal temperature
- Dry at low temperature
- Do not tumble-dry

When sorting the laundry to be dried, take the following points into account:

- To achieve an even drying result, only dry laundry of the same type of fabric and texture together. If you dry thin, thick and multi-layered fabrics together, they will dry to differing degrees.
- Use the fabric descriptions given for the individual drying programmes to help you choose the most appropriate programme.
→ *"Overview of programmes"*
on page 22

Note: You can select a timed programme to add extra drying time for laundry that is still damp.

Caution!

Risk of material damage to the appliance and laundry

Do **not** tumble-dry the following items or fabrics in the appliance:

- Laundry contaminated with solvents, wax or grease.
- Unwashed items.
- Items made from non-breathable fabrics (e.g. rubber-coated).
- Items made from delicate fabrics, such as silk and curtains made of synthetic material.



Operating the appliance

Loading laundry and switching on the appliance

Note: The appliance must be correctly installed and connected. → *Page 12*

1. Prepare and sort the laundry.
2. Press  to switch on the appliance.

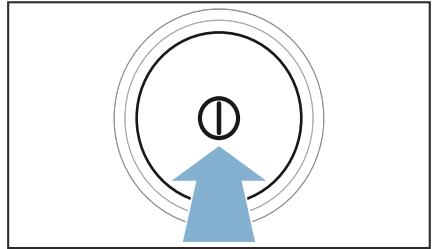

3. Open the door.
Check that the drum has been completely emptied. Empty it if necessary.

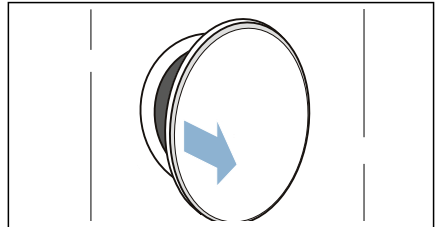

4. Load the laundry unfolded into the drum.

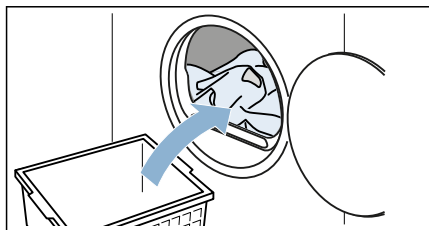

5. Close the appliance door.

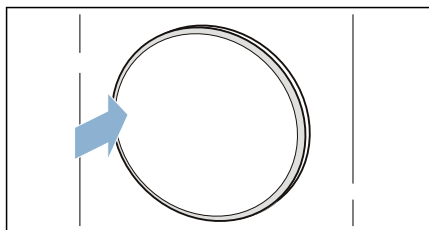

Caution!

Risk of material damage to the appliance or laundry.

Make sure that laundry is not trapped in the door.

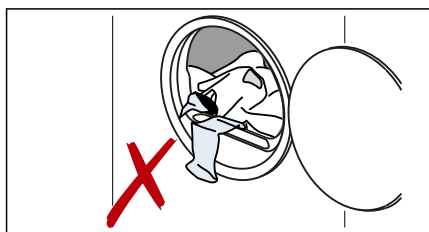

Note: The appliance's drum is lit up after the door is opened and closed and once the programme has started. The drum's interior light goes out on its own.

Setting a programme

Note: If you have activated the childproof lock, you must deactivate it before you can set a programme.
→ Page 16

1. Select the programme you require.
→ "Overview of programmes" on page 22
2. Set the programme you require.

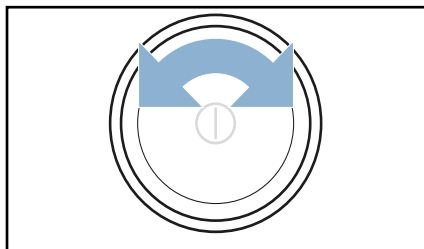

The programme settings will appear on the display.

3. Adjust the programme settings, if required.
→ "Programme settings" on page 24

Starting a programme

Press **Start/Pause** .

Note: If you want to prevent the programme from being adjusted inadvertently, you can activate the childproof lock. → Page 16



Programme progress

The programme status will be indicated on the display.

Note: When a programme is selected, the expected drying time for the maximum permitted load is displayed. The moisture sensor measures the residual moisture in the laundry as it is being dried. The programme duration and the remaining time indicated on the display are automatically adjusted as the programme progresses, depending on how damp the laundry is (exception: Timed programmes).

Changing the programme or adding more laundry

You can remove or add laundry and change or adjust the programme at any time during drying.

1. Open the door or press **Start/Pause**  to pause the programme.
2. Add or remove laundry.
3. If required, select a different programme or a different programme setting.
→ "Overview of programmes" on page 22
→ "Programme settings" on page 24
4. Close the door.
5. Press **Start/Pause** .

Note: The programme duration is updated on the display, depending on the load and on the residual moisture in the laundry. The values displayed may change when the programme or load is changed.

Cancelling the programme

The programme can be cancelled at any time by opening the door or pressing **Start/Pause** .

Caution!

Risk of fire. Laundry may catch fire.

If you cancel the programme, remove all items of laundry from the dryer and spread them out to allow the heat to dissipate.

Programme end

-  - will appear on the display.

Removing laundry and switching off the appliance

1. Remove the laundry.

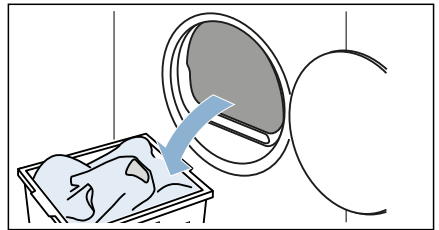

2. Press  to switch off the appliance.

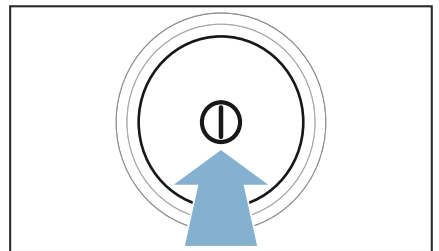

Emptying the condensation container

By default, the condensation from the appliance runs into the condensation container.

Alternatively, you have the option of discharging the condensation water* supplied depending on the model. If you choose to discharge the condensation water into the waste-water system, you will not need to empty the condensation container during the drying programme or after each time you use the dryer.

1. Pull out the condensation container horizontally.

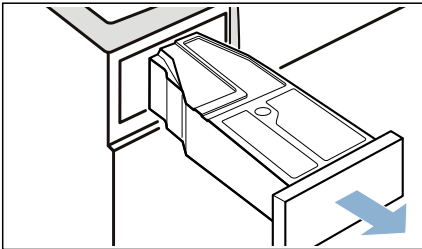

2. Pour out the condensation water.

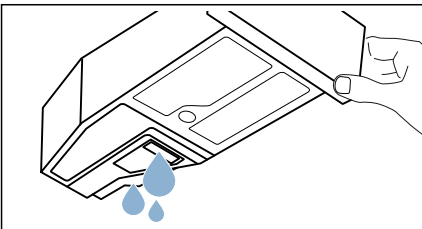

Caution!

Risk of harm to health and material damage

Condensation water is not suitable for drinking and may be contaminated with fluff.

Contaminated condensation water may be harmful to your health and cause material damage. Do not drink the condensation water or reuse it.

3. Push the condensation container back into the appliance until you feel it lock into place.

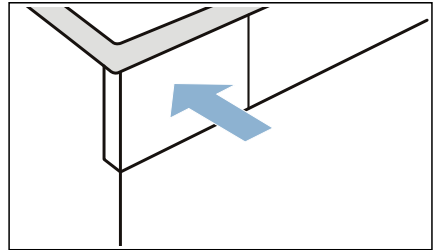

Note: The filter in the condensation container filters the condensation water, which is used during the appliance's automatic cleaning cycle. The filter is cleaned by emptying out the condensation water. You should still check the filter regularly for any build-up, and remove this if necessary.

→ "Cleaning the filter in the condensation container" on page 42

Removing the fluff

Note: During drying, fluff and hair from the laundry is trapped by the fluff filter. If the fluff filter is clogged or dirty, this reduces the flow of air, preventing the appliance from achieving optimal drying results. Dirty fluff filters increase the power consumption and increase the required drying time.

* into the waste-water system via a drain hose

Clean the fluff filter after each drying cycle:

1. Open the door and remove all fluff from it.
2. Pull out the two-part fluff filter.

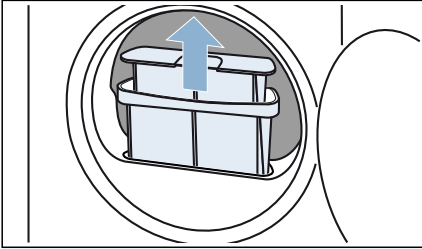

3. Remove the fluff from the fluff filter recess. Ensure that no fluff falls into the open shaft.

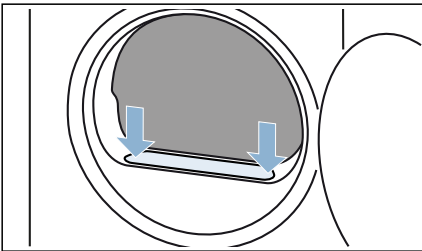

4. Pull the two-part fluff filter apart.

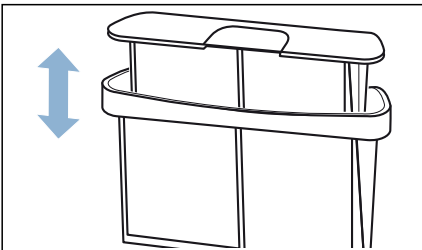

5. Open the two parts of the filter.

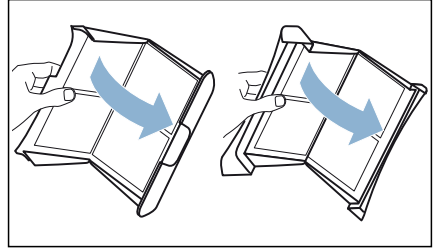

6. Remove all fluff from both parts of the filter.

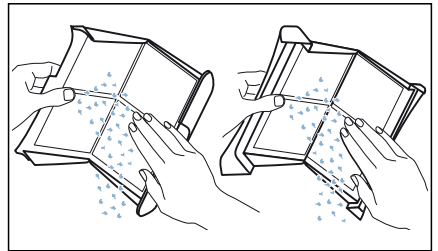

7. Rinse off fluff under warm, running water.

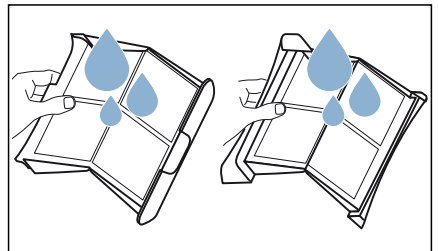

8. Dry the two parts of the fluff filter, snap them shut and reinsert the filter.

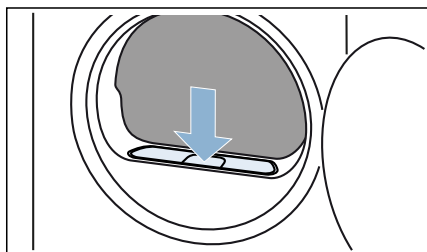

Caution!
Material damage/damage to the appliance

If you operate the appliance without a fluff filter, or if the fluff filter is defective, this may result in damage to the appliance.

Do not operate the appliance without a fluff filter, or with a fluff filter that is defective.

 **Home Connect**

This appliance is Wi-Fi enabled and can be controlled remotely via a smartphone or tablet PC.

With the Home Connect app, you can use your smartphone or tablet PC to do the following on this appliance:

- Select and start programmes.
- Change programme settings.
- Query the status of programmes.
- Change appliance settings.
- Switch off the appliance.

Before you can use the Home Connect functions, you will need to install the Home Connect app on your smartphone or tablet PC, register, connect your appliance automatically **or** manually to your home network (you only need to do this the first time) and then connect your mobile device to your appliance via the Home Connect app.

You can find information about the app on our Home Connect website www.home-connect.com.

The availability of the Home Connect function depends on the availability of Home Connect services in your country. Home Connect services are not available in every country. You can find more information on this at www.home-connect.com.

Notes

- Please observe the safety precautions in this instruction manual and make sure that these are complied with even when operating the appliance via the Home Connect app while you are away from home. You must also follow the instructions in the Home Connect app.

- You cannot use the Home Connect app to make changes while the appliance controls are being operated. You will be able to use the Home Connect app to see any adjustments made directly on the appliance itself, however.

Connecting to your home network automatically



If your router has a WPS function, you can connect the appliance to your home network automatically.

If your router does not have a WPS function, you will need to connect the appliance to your home network manually.

Wi-Fi must be switched on at the appliance.

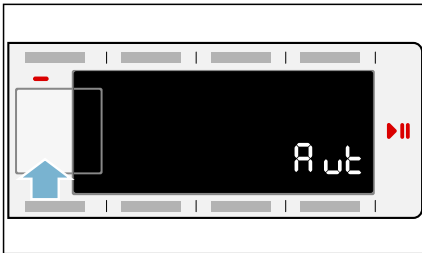
1. Switch on the appliance.
2. Press and hold **Remote Start**  for at least 3 seconds. **Auto** (connect automatically) will appear on the display.



3. Press Start/Pause  to connect to the network.  will flash on the display.

The appliance will now try to connect to your home network.

4. Activate the WPS function on your home network router within the next 2 minutes.

If the appliance has connected to your home network successfully, **Con** (connected) will appear on the display and  will be lit continuously.

5. Press **Remote Start**  briefly to exit the Home Connect settings.

Note: If a connection could not be established, **Err** (fault) will appear on the display. Check whether your appliance is in range of your home network. Try connecting automatically again or connect your appliance manually.

Connecting to your home network manually

If your appliance has already been automatically connected to your home network, you can skip the manual connection step.

If your router does not have a WPS function, you will need to connect the appliance to your home network manually.



Wi-Fi must be switched on at the appliance.

1. Switch on the appliance.
2. Press and hold **Remote Start**  for at least 3 seconds. **Auto** (connect automatically) will appear on the display.



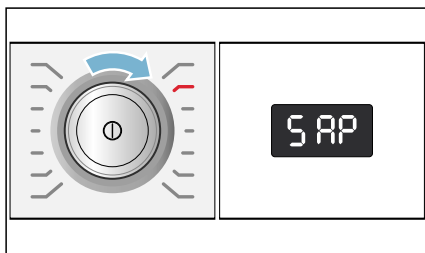

- Turn the programme selector to position 2.
SAP (connect manually) will appear on the display.



- Press Start/Pause  to connect to the network.  will flash on the display.

The appliance will now set up its own Wi-Fi network with the name (SSID) **Home Connect**. You can access this using your smartphone or tablet PC.

- Call up the Wi-Fi settings on your smartphone or tablet PC.
- Connect your smartphone or tablet PC to the **Home Connect** Wi-Fi network and enter the password (key) "**HomeConnect**".
Note: The connection process may take up to 60 seconds.
- Once you have connected successfully, open the Home Connect  app on your smartphone or tablet PC.
- In the Home Connect app, enter the name (SSID) and password (key) for **your home network** and then select **Transfer to appliance**.

If the appliance has connected to your home network successfully,  (connected) will appear on the display and  will be lit continuously.

- Press **Remote Start**  briefly to exit the Home Connect settings.

Notes

- If a connection could not be established, **Err** (fault) will appear on the display. Check whether your appliance is in range of your home network. Try connecting manually again.
- If your smartphone or tablet PC is still connected to the **Home Connect** network, you will need to connect it to your home network first.

Connecting to the Home Connect app

If your appliance is connected to your home network, you can connect it to the Home Connect app.

- Switch on the appliance.
- Press and hold **Remote Start**  for at least 3 seconds.
Aut (connect automatically) will appear on the display.

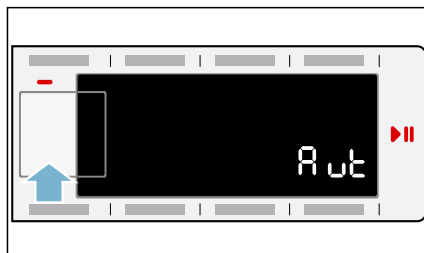

- Turn the programme selector to position 3.
APP (connect to app) will appear on the display.

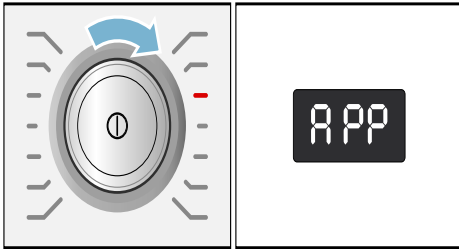

- Press Start/Pause .
The appliance will now connect to your Home Connect app.
- Open the Home Connect app on your smartphone or tablet PC and select **Connect** to add your new appliance.
Note: If your smartphone or tablet PC is still connected to the Home Connect network, you will need to connect it to your **home network** first.
- If your appliance is not shown automatically, select **Appliance search** and then **Connect an appliance** in the Home Connect app.
- Carry out the last steps in the Home Connect app to connect your appliance.

If the appliance has connected to your home network successfully, *Con* (connected) will appear on the display.

- Press **Remote Start**  briefly to exit the Home Connect settings.

Note: If a connection could not be established, *Err* (fault) will appear on the display. Check whether your smartphone or tablet PC is in range of your home network and whether it is connected to it. Try connecting to the Home Connect app again.

Switching Wi-Fi on and off

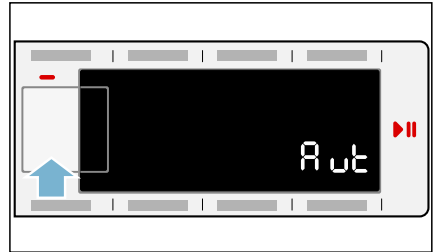

You can switch the Home Connect function on your appliance on or off permanently at any time.

- Switch on the appliance.
- Press and hold **Remote Start**  for at least 3 seconds.
Aut (connect automatically) will appear on the display.

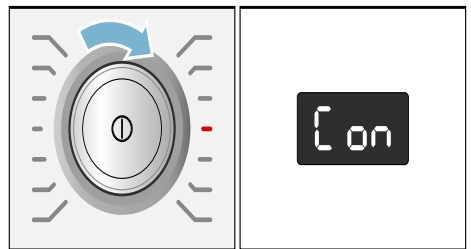

- Turn the programme selector to position 4.
Con (Wi-Fi function) will appear on the display.



- Press Start/Pause .
If *on* (switched on) appears on the display, the Wi-Fi function on the appliance has been activated. If *off* (switched off) appears on the display, the Wi-Fi function is not active.
- Press **Remote Start**  briefly to exit the Home Connect settings.

Notes

- If Wi-Fi is switched off on the appliance, the appliance cannot be connected to your home network or the app.
- If Wi-Fi is switched on on the appliance, when it is in Energy saving mode, the appliance will not automatically switch itself off.
- If Wi-Fi is switched on on the appliance and you wish to switch it off, you must perform all these steps again.

Resetting your network settings

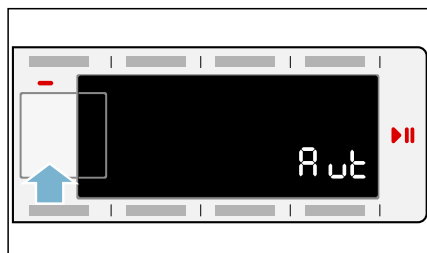

You can clear the network settings and break the connection to your smartphone or tablet PC by resetting the network settings.

1. Switch on the appliance.
2. Press and hold **Remote Start**  for at least 3 seconds. **Aut** (connect automatically) will appear on the display.

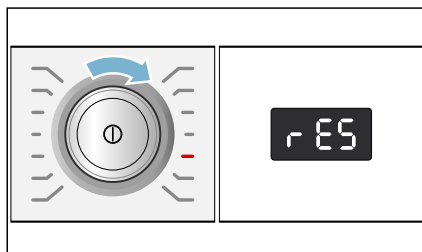

3. Turn the programme selector to position 5. **rES** (reset network settings) will appear on the display.



4. Press Start/Pause . **YES** (yes) will appear on the display.
5. Press Start/Pause  to confirm. **End** (end) will appear on the display. The network settings have now been reset. Your appliance is no longer connected to your home network or the Home Connect app.
6. Press **Remote Start**  briefly to exit the Home Connect settings.

Notes

- If the network settings could not be reset, **Err** (fault) will appear on the display.
- If you want to operate the appliance via the Home Connect app again, you will need to reconnect it to your home network and to the Home Connect app either automatically or manually.

Updating the software

You can update the Home Connect software on your appliance. Whenever a new update is available, **UPd** (update) will appear on the display.

You can install the update directly via the message on the display or, alternatively, via the appliance settings.

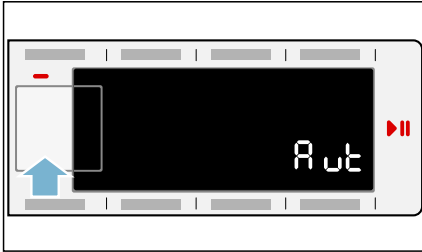

1. Switch on the appliance.
2. Press and hold **Remote Start**  for at least 3 seconds.
Aut (connect automatically) will appear on the display.

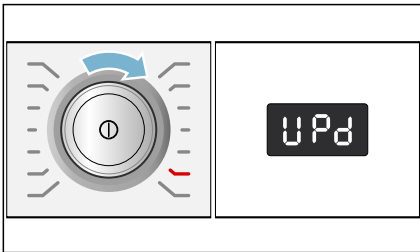

3. Turn the programme selector to position 6.
UPd (update) will appear on the display.



Start/Pause  will flash if a software update is available.

4. Press Start/Pause .
- YES** (yes) will appear on the display.
5. Press Start/Pause  to confirm.
Update installation will now start. This process may take several minutes. Do not switch the appliance off while updates are being installed.
6. Press **Remote Start**  briefly to exit the Home Connect settings.

Information on data protection

When your appliance is connected for the first time to a Wi-Fi network, which is connected to the Internet, your appliance transmits the following categories of data to the Home Connect server (initial registration):

- Unique appliance identification (consisting of appliance codes as well as the MAC address of the installed Wi-Fi communication module).
- Security certificate of the Wi-Fi communication module (to ensure a secure data connection).
- The current software and hardware version of your household appliance.
- Status of any previous resetting to factory settings.

This initial registration prepares the Home Connect functions for use and is only required when you want to use these Home Connect functions for the first time.

Note: Ensure that the Home Connect functions can be used only in conjunction with the Home Connect app. Information on data protection can be accessed in the Home Connect app.

Declaration of Conformity

BSH Hausgeräte GmbH hereby declares that the appliance with Home Connect functionality meets the basic requirements and other relevant provisions of the Directive 1999/5/EC.

A detailed R&TTE Declaration of Conformity can be found online at www.bosch-home.com among the additional documents on the product page for your appliance.



Replacing the condensation drain

By default, the condensation from the appliance runs into the condensation container.

Alternatively, you have the option of discharging the condensation water into the waste-water system via a drain hose. If you choose to discharge the condensation water into the waste-water system, you will not need to empty the condensation container during the drying programme or after each time you use the dryer.

Replace the condensation drain as follows:

1. Remove any accessories from the drum.

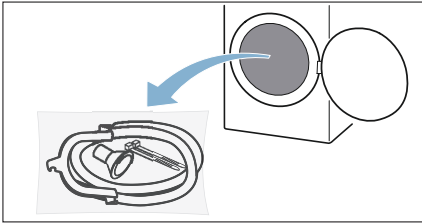

2. Remove all items from the bag.

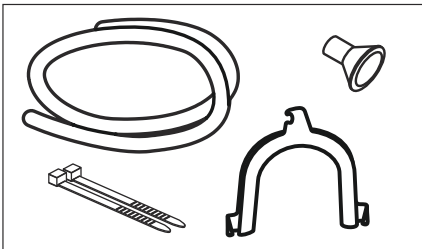

3. Detach the condensation hose from the socket.

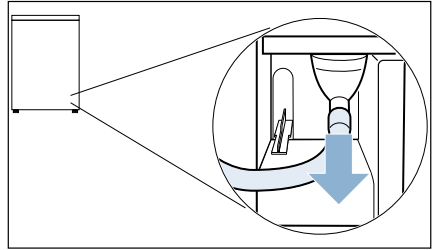

Note: The appliance comes delivered with the condensation hose already fitted to the socket.

4. Place the condensation hose in the "parked" position.

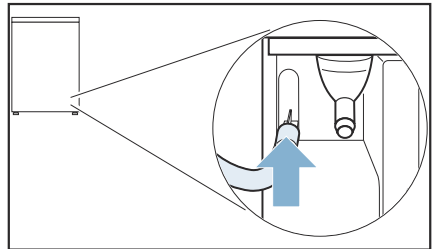

5. Take the drain hose from the accessories and attach it to the free socket, pushing it up to the stop.

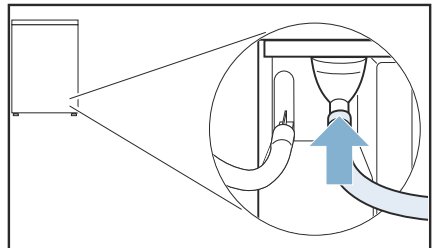

- Secure the other end of the drain hose in place using the remaining accessories (depending on the connection type).

Wash basin:

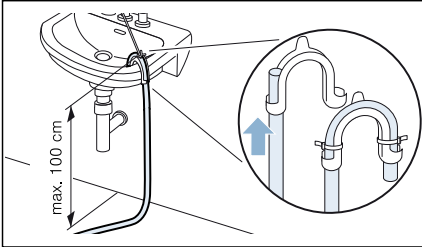

Siphon:

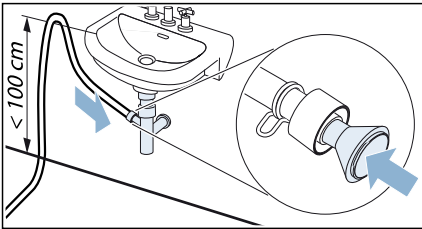

The connection point must be secured using a hose clamp (clamping range 12-22 mm).

Floor drain:

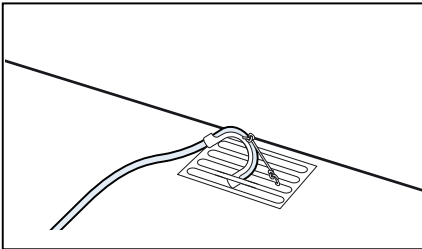

Caution!

Risk of material damage due to leaks or draining water.

Secure the drain hose to prevent it from slipping out. Do not kink the drain hose. The difference in height between the installation surface and the drain should not exceed 100 cm.

Caution!

Risk of accumulated water being drawn back into the appliance and causing material damage.

Check that the water drains away quickly. The drain must not be sealed or blocked.

- Pull out the condensation container horizontally and empty it.

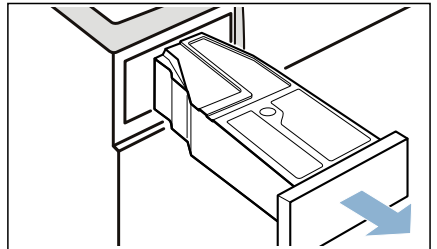

- Turn the condensation container 180° onto its underside and remove the stopper that is fitted.

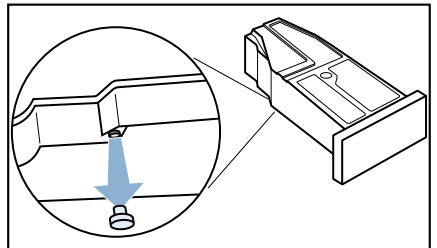

en Replacing the condensation drain

- 9.** Turn the condensation container 180° again and insert the stopper into the recess in the top of the condensation container.

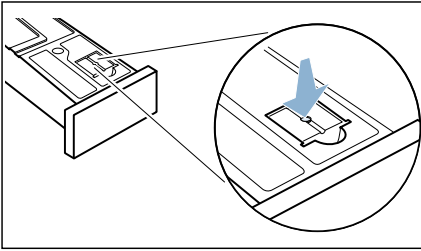

- 10.** Pull the filter out of its snap-in lock.

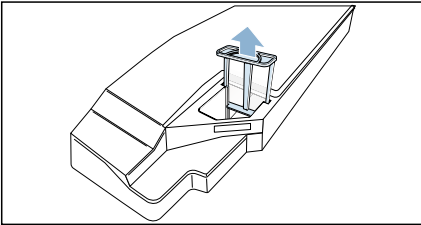

- 11.** Place the filter into the recess on the condensation container.

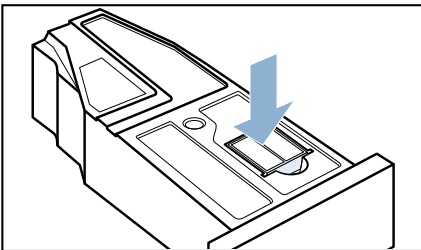

- 12.** Slide in the condensation container until it clicks into place.

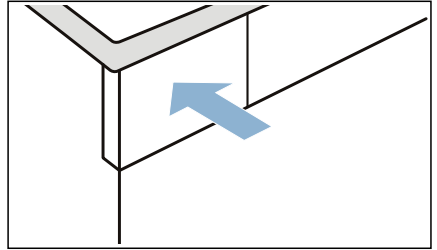

The condensation water is now discharged via the drain hose into the waste-water system or into a washbasin.

Note: If you want to change the condensation drain back to the condensation container, carry out all these steps in reverse order.

Caution!

Risk of material damage/damage to the appliance

If you are draining condensation water into the condensation container, liquid may leak out of the socket and cause material damage. Before operating the appliance, make sure that the condensation hose is secured to the socket.



Cleaning and maintenance

Cleaning the appliance



Warning **Risk of death!**

The appliance is powered by electricity. There is a risk of electric shock if you come into contact with live components. Therefore please note:

- Switch off the appliance. Disconnect the appliance from the power supply (pull out the plug).
- Never take hold of the mains plug with wet hands.
- When removing the mains plug from the socket, always take hold of the plug itself and never the mains cable, otherwise this may damage the mains cable.
- Do not make any technical modifications to the appliance or its features.
- Repairs and any other work on the appliance must only be conducted by our customer service or by an electrician. The same applies for replacing the mains cable (when necessary).
- Spare mains cables can be ordered from our customer service.



Warning **Risk of poisoning!**

Poisonous fumes may be given off by cleaning agents that contain solvents, e.g. cleaning solvent. Do not use cleaning agents that contain solvents.



Warning **Risk of electric shock/material damage/damage to the appliance!**

If moisture penetrates the appliance, this may cause it to short circuit. Do not use a pressure washer or steam cleaner to clean your appliance.

Caution! **Material damage/damage to the appliance**

Cleaning agents and agents for pretreating laundry (e.g. stain removers, prewash sprays, etc.) may cause damage if they come into contact with the surfaces of the appliance. Therefore please note:

- Do not allow these agents to come into contact with the surfaces of the appliance.
- Clean the appliance with nothing but water and a soft, damp cloth.
- Remove any detergent, spray or other residues immediately.

Cleaning the moisture sensor

Note: The moisture sensor measures the amount of moisture in the laundry. After long periods of usage, the moisture sensor may become covered by a fine layer of limescale or detergent and care product residue. These deposits must be removed regularly, otherwise the drying results may not be optimal.

1. Open the door.

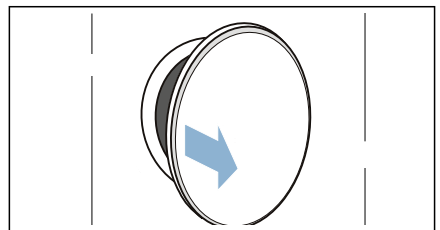

en Cleaning and maintenance

2. Clean the moisture sensor with a rough sponge.

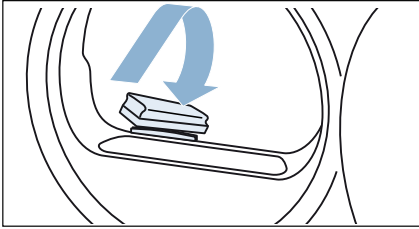

Caution!

Risk of damaging the moisture sensor.

The moisture sensor is made from stainless steel. Do not clean the sensor with abrasive cleaning products or wire wool.

Cleaning the filter in the condensation container

Note: The filter in the condensation container cleans the condensation water, which is used during the appliance's automatic cleaning cycle.

1. Pull out the condensation container horizontally.

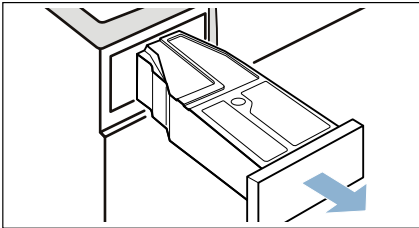

2. Pour out the condensation water.

3. Remove the filter.

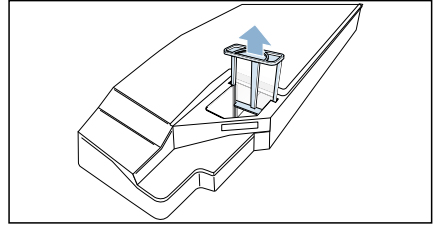

4. Clean the filter under warm, running water or in the dishwasher.
5. Push the filter in until you feel it lock into place.

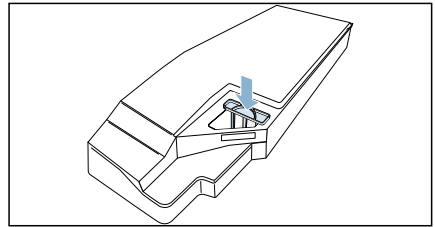







Caution!

If the filter is not inserted, fluff can find its way inside the appliance and damage it.

Only operate the appliance with the filter inserted.

6. Push the condensation container in until you feel it lock into place.

Information on the display

Faults	Cause/remedy
 on the display and drying has stopped.	<ul style="list-style-type: none"> ■ Empty the condensation container and reinsert it. → <i>Page 30</i> Press Start/Pause . ■ Once you have installed the optional drain hose*, make sure that it: Is correctly connected → <i>Page 38</i> Is free of kinks Is not blocked or clogged, e.g. with deposits
 on the display.	Remove the fluff. → <i>Page 30</i> Press Start/Pause  .
 on the display.	Not a fault. The heat exchanger is being cleaned automatically. Do not pull out the condensation container while this is displayed.
I am unable to connect to my home network.	<ul style="list-style-type: none"> ■ Wi-Fi is switched off. To connect to your home network, switch on Wi-Fi.  must appear on the display. ■ Wi-Fi is switched on but a connection to your home network cannot be established. Check whether your home network is available or try to connect to your home network again.
The display goes out and Start/Pause  flashes.	Not a fault. Energy saving mode is active .
* Depending on how the appliance is equipped or the available accessory	

Note: If you cannot rectify the fault yourself by turning the appliance off and then on again, please contact our after-sales service. → *Page 50*

Help with the appliance

Faults	Cause/remedy
Appliance does not start.	<ul style="list-style-type: none"> ■ Check the mains plug and fuse. ■ Check whether a programme has been selected. ■ Check that the appliance door is closed. ■ Check whether the childproof lock is activated. If it is, deactivate the childproof lock. → <i>Page 16</i> ■ Check whether a "Ready in" time has been selected. If it has, this will delay the start of a selected programme.
Creasing.	<ul style="list-style-type: none"> ■ Load exceeded or incorrect programme selected for a type of fabric. All the required information can be found in the programme table. → <i>Page 22</i> ■ Remove laundry from the drum as soon as the drying programme has finished. Creasing occurs when clothing is left in the drum.
Water is leaking out.	The appliance may be positioned at an angle. Level the appliance. → <i>Page 13</i>
Programme duration displayed changes as drying progresses.	Not a fault. The moisture sensor measures the residual moisture in the laundry and adjusts the programme duration (with the exception of timed programmes).
Laundry is not dried properly or is still too damp.	<ul style="list-style-type: none"> ■ After the programme has ended, warm laundry feels damper than it actually is. Spread out the laundry and let it cool down. ■ Adjust the drying time or increase the degree of dryness. This will extend the drying time but the temperature will remain the same. ■ Select a timed programme to add extra drying time for laundry that is still damp. ■ Select a timed programme for a small load. ■ Do not exceed the maximum load for a programme. → <i>Page 22</i> ■ Clean the moisture sensor in the drum. The sensor may become covered in a fine layer of limescale or detergent and care product residue, which then impairs its performance. → <i>Page 41</i> ■ Drying has been interrupted as a result of a power cut, because the condensation container is full or because the maximum drying time has been exceeded. <p>Note: See also the laundry tips. → <i>Page 26</i></p>
Drying taking too long.	<ul style="list-style-type: none"> ■ The appliance may have fluff in it. This will increase the drying time. Remove the fluff. → <i>Page 30</i> ■ If the air inlet on the appliance is blocked or not fully open, the drying time may increase. Make sure that the air inlet remains unobstructed. ■ If the ambient temperature is lower than 15 °C or higher than 30 °C, this may increase the drying time. ■ Inadequate air circulation in the room may increase the drying time. Make sure the room is adequately ventilated.
Humidity in the room is increasing.	Make sure the room is sufficiently ventilated.

Drying programme is stopped.	If the drying programme is stopped due to a power failure, restart the programme or remove the laundry and spread it out.
Unusual noises when drying.	Automatic cleaning of the heat exchanger produces noises. This does not indicate that there is a malfunction on the appliance.
The appliance feels cold despite drying.	Not a fault. The appliance can dry effectively at low temperatures using a heat pump.
Home Connect is not working.	<ul style="list-style-type: none"> ■ You can find solutions to problems with Home Connect at www.home-connect.com. ■ The availability of the Home Connect functionality depends on the availability of the Home Connect Services (e.g. provision of the app) in your country. Home Connect Services are not available in every country – for further information please check: www.home-connect.com.
Residual water in the condensation container despite the appliance being connected to the drain hose*.	If the optional drain hose is installed, residual water remains in the condensation container due to the appliance's self-cleaning function.
* Depending on how the appliance is equipped or the available accessory	

Note: If you cannot rectify the fault yourself by turning the appliance off and then on again, please contact our after-sales service. → Page 50



Transporting the appliance

Warning

Risk of injury/material damage/ damage to the appliance!

If you take hold of any of the appliance's protruding parts (e.g. the appliance door) in order to lift or move it, these parts may break off and cause injury. Do not take hold of any of the appliance's protruding parts in order to move the appliance.

Warning

Risk of injury!

- The appliance is very heavy. Lifting it may result in injury. Do not lift the appliance on your own.
- The appliance has sharp edges on which you could cut your hands. Do not take hold of the appliance by its sharp edges. Wear protective gloves to lift it.

Prepare the appliance for transportation as follows:

1. Pull out the condensation container horizontally.

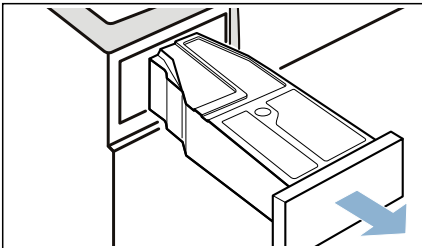

2. Empty the condensation container.

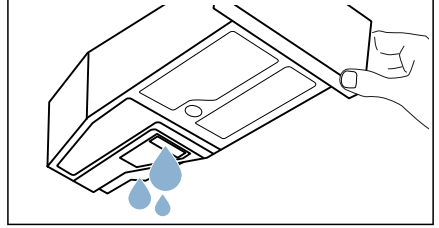

3. Push the condensation container back into the appliance until you feel it lock into place.

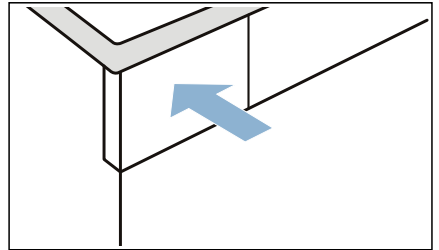

4. Press  to switch on the appliance.

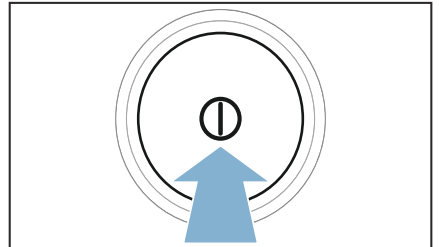

5. Select any programme.

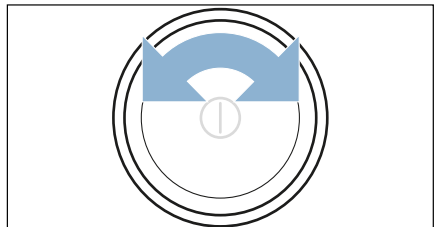

6. Press **Start/Pause** ▷|||.
7. Wait for 5 minutes.
The condensation water will be drained.
8. If installed, remove the drain hose from the washbasin, siphon or floor drain. → *Page 38*

Caution!

Secure the drain hose to the appliance to prevent it from slipping out. Do not kink the drain hose.

9. Switch off the appliance.

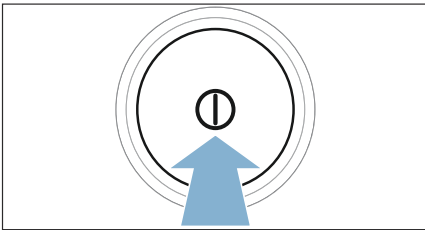

10. Disconnect the appliance's mains plug from the power supply.
The appliance is now ready to be transported.





Caution!

Risk of material damage/damage to the appliance

- Despite draining, there will always be some residual water in the appliance. Any residual water may leak out and cause material damage.
The appliance should therefore be transported upright.
- The appliance contains refrigerant and may be damaged if it is operated immediately after transportation.
Allow the appliance to rest for two hours before initial use.

Consumption values

Consumption values table

Programme	Spin speed used for spinning the laundry (in rpm)	Duration** (in min)		Energy consumption** (in kWh)	
 Cottons		9 kg	4,5 kg	9 kg	4,5 kg
Cupboard Dry  *	1400	133	82	1.72	0.98
	1000	157	97	2.13	1.21
	800	181	112	2.48	1.41
Iron Dry  *	1400	98	61	1.22	0.69
	1000	123	76	1.62	0.92
	800	147	91	2.00	1.14
Easy-Care		3,5 kg		3,5 kg	
Cupboard Dry  *	800	50		0.55	
	600	64		0.69	



In order to test the appliance in accordance with the applicable EN 61121 standard, connect the external condensation drain hose. → *Page 38*

* Programme setting for testing in accordance with the applicable EN 61121 standard.

** The values may differ from those specified, depending on the type of fabric, composition of laundry to be dried, residual moisture in the laundry, the degree of dryness that has been set, the amount of laundry being loaded and the environmental conditions.

Most efficient programme for cotton laundry

The "standard cottons programme" below (denoted by the  symbol) is suitable for drying cotton laundry with a normal dampness level, and is the most efficient programme for drying damp cotton laundry in terms of combined energy consumption.

Standard programmes for cottons in accordance with current EU regulation 932/2012			
Programme + dryness level	Load (in kg)	Energy consumption (in kWh)	Programme duration (in min)
 Cottons + Cupboard Dry 	9/4.5	2.13/1.21	157/97

Programme setting for testing and energy labelling in accordance with Directive 2010/30/EU.



Technical specifications

Dimensions:

85 x 60 x 60 cm
(height x width x depth)

Weight:

Approx. 57 kg

Maximum load:

9 kg

Mains voltage:

220 - 240 V

Connected load:

Max. 1000 W

Fuse:

10 A

Drum interior light*

Ambient temperature:

5 - 35 °C

Power consumption when switched off:

0.10 W

Power consumption when ready for use (standby):

0.10 W

Power consumption when networked (Wi-Fi) in standby mode/duration:

2.3 W / 2.3 mins



Disposal



Dispose of packaging and the appliance in an environmentally responsible manner.

This appliance is labelled in accordance with the European Directive 2012/19/EU, which governs waste electrical and electronic equipment (WEEE). The directive provides a framework for the collection and recycling of old appliances, which is valid across the EU.

The appliance's heat exchanger contains fluorinated greenhouse gas in a hermetically sealed unit.

Greenhouse gas:	R407C
Filling quantity (kg):	0.290
Total GWP (tCO ₂):	0.514

* Depending on how the appliance is equipped



After-sales service

If you cannot rectify the fault yourself by turning the appliance off and then on again, please contact our after-sales service. → Enclosed after-sales service directory or cover page

We will always find an appropriate solution in order to avoid unnecessary visits by engineers.

Please provide the after-sales service with the product number (E no.) and the production number (FD) of the appliance.

E-Nr. _____	FD _____
-------------	----------

E no. Product number
FD Production number

You can find this information, depending on the model*:

On the inside of the door*/open service flap* and at the rear of the appliance.

Trust in the expertise of the manufacturer.

Contact us for assistance. By doing so, you can be sure that the repairs are carried out by trained service engineers using genuine spare parts.





Advice and repair order in the event of faults

GB 0344 892 8979 (Calls charged at local or mobile rate.)

IE 01450 2655 (0.03 € per minute at peak. Off peak 0.0088 € per minute.)

You can find the contact information for all countries in the attached after-sales service directory.

Robert Bosch Hausgeräte GmbH
Carl-Wery-Straße 34
81739 München, GERMANY



9001225839 (9608)