

de Montageanleitung	ru Инструкция по монтажу	bs Uputa za montažu
en Installation instructions	cs Montážní návod	fa راهنمایی مونتاژ
fr Notice de montage	pl Instrukcja montażu	ar تعليمات التركيب
nl Montagevoorschrift	hu Szerelési utasítás	ko 설치 설명서
it Istruzioni per il montaggio	hr Uputa za montažu	zh 安装说明
el Οδηγίες τοποθέτησης	mk Упатство за монтажа	uk Інструкція з монтажу
es Instrucciones de montaje	sl Navodilo za montažo	ro Instrucțiunea de montaj
pt Instruções de montagem	sr Uputstvo za montažu	bg Упътване за монтаж
sv Monteringsanvisning	et Monteerimisjuhend	ja インストールに関する指示
no Monteringsanvisning	lt Montavimo instrukcija	he הוראות התקנה
fi Asennusohje	lv Montāžas pamācība	id Instruksi Pemasangan
da Monteringsvejledning	sk Návod na montáž	kk Іске қосу туралы нұсқаулар
tr Montaj kılavuzu	sq Udhëzues për montim	

de *) über Kundendienst erhältlich	sl *) Lahko nabavite v servisni službi
en *) Available from customer service	sr *) Može se nabaviti preko servisne službe
fr *) Disponible par le biais du service après-vente	et *) küsige klienditeeninduselt
nl *) Tegen meerprijs bij de Servicedienst verkrijgbaar	lt *) Ją galima gauti klientų aptarnavimo servise
it *) Disponibili presso il servizio assistenza clienti	lv *) Var saņemt servisa dienestā
el *) Διατίθενται από την υπηρεσία τεχνικής εξυπηρέτησης πελατών	sk *) Dostanete v službe zákazníkom
es *) Se puede adquirir a través del Servicio de Asistencia Técnica Oficial de la marca	sq *) Sigurohet nëpërmjet servisit
pt *) Pode ser adquirido nos nossos Serviços Técnicos	bs *) Može se dobiti preko servisne službe
sv *) kan fås via Service	fa *) از مرکز خدمات پس از فروش تهیه فرمائید
no *) fåes hos kundeservice	ar *) يمكن طلبها من مراكز خدمة العملاء
fi *) Saatavissa huoltopalvelusta	ko *) 고객센터 서비스 센터에서 구입 가능
da *) Kan købes hos serviceafdelingen	zh *) 可通过售后服务部门购得
tr *) Yetkili servis üzerinden alınabilir	uk *) Можна отримати через сервісну службу
ru *) Можно получить в сервисном центре	ro *) Se obține de la serviciul pentru clienți
cs *) K dispozici přes servisní službu	bg *) може да се намери в специализираните сервиси
pl *) Do uzyskania w punkcie serwisowym	ja *) 顧客サービスから利用可能
hu *) A vevőszolgálaton keresztül kapható	he *) להשיג בתחנת שירות הלקוחות
hr *) može dobiti kod službe održavanja	id *) bisa didapatkan melalui Customer Service
mk *) се добива преку службата за купувачи	kk *) Сервис қызмет көрсету орталығында алуына жатады

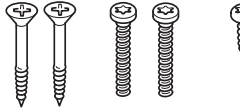

Ø4X36 Ø4X30 Ø4X13



Ø4X13

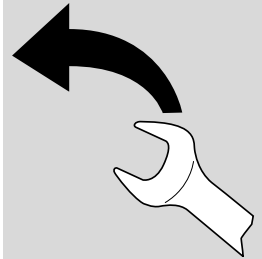
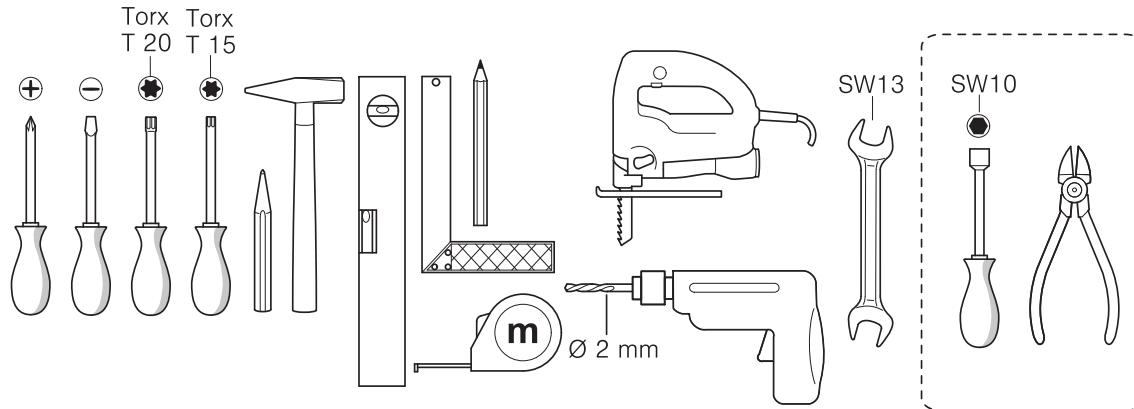
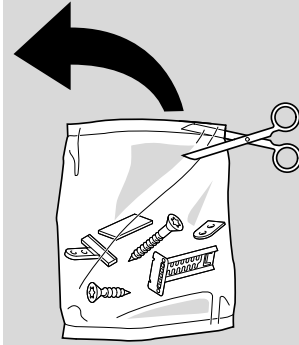
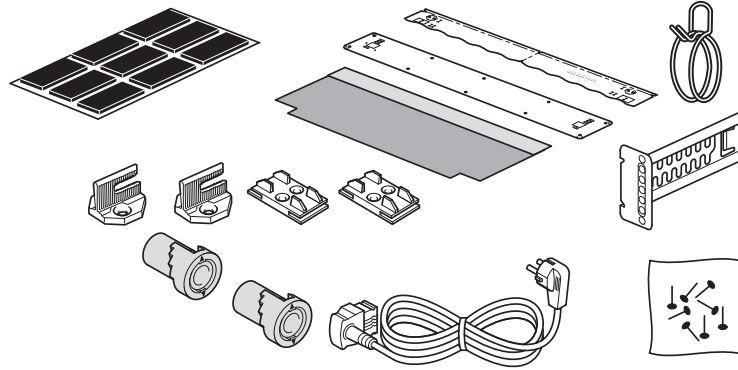

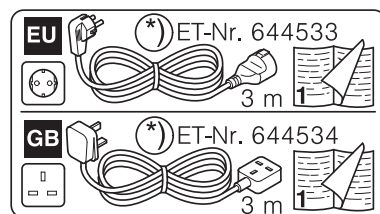
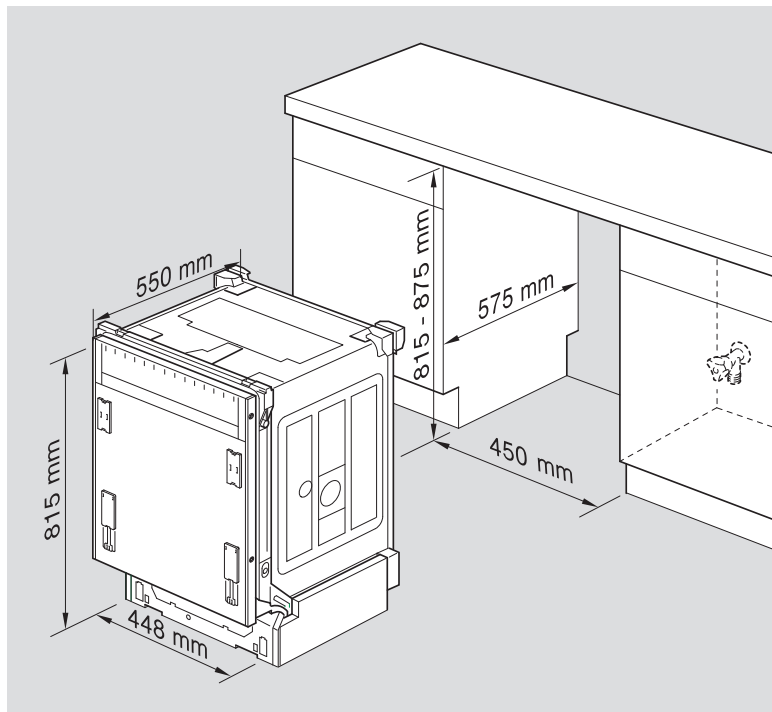
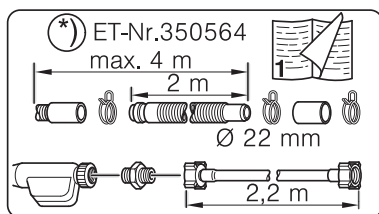
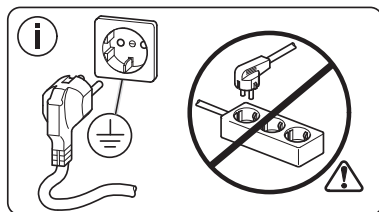
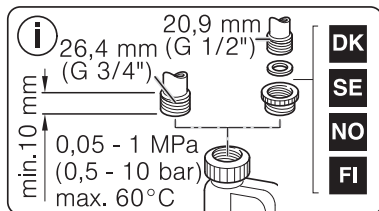
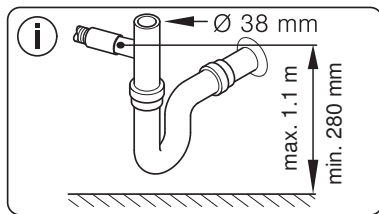

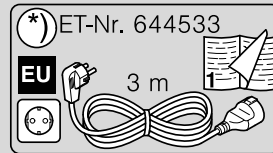
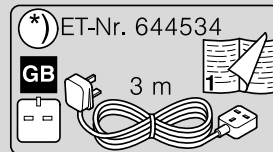
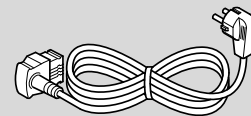
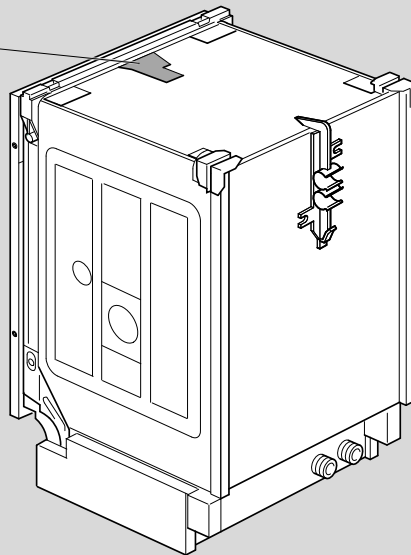
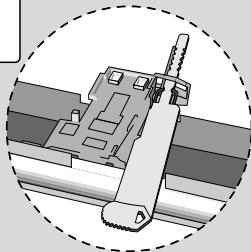
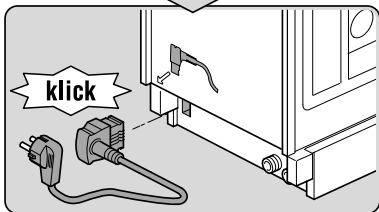
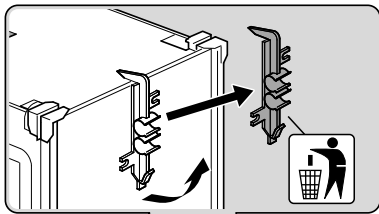

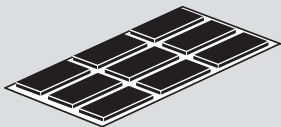
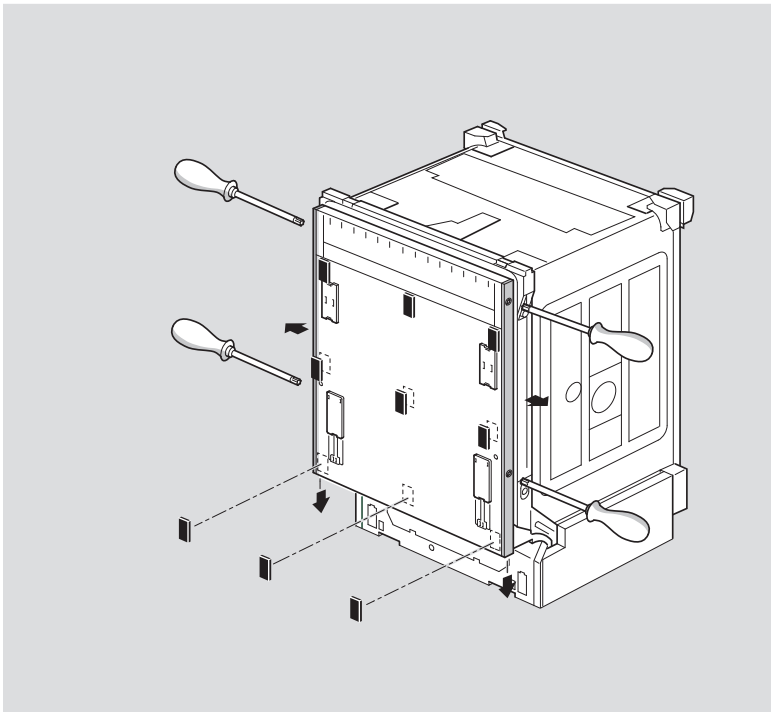
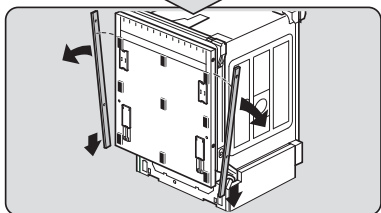
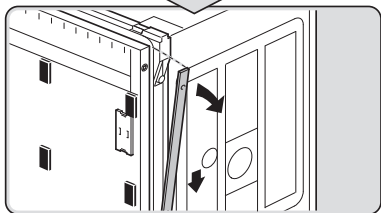
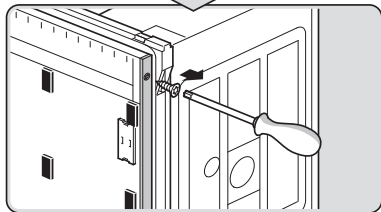
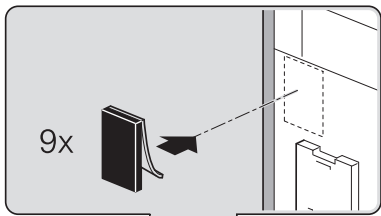

Torx
T 15



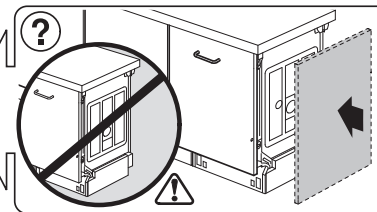
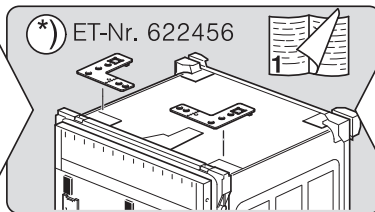
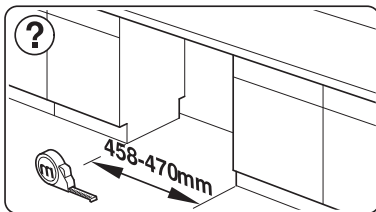
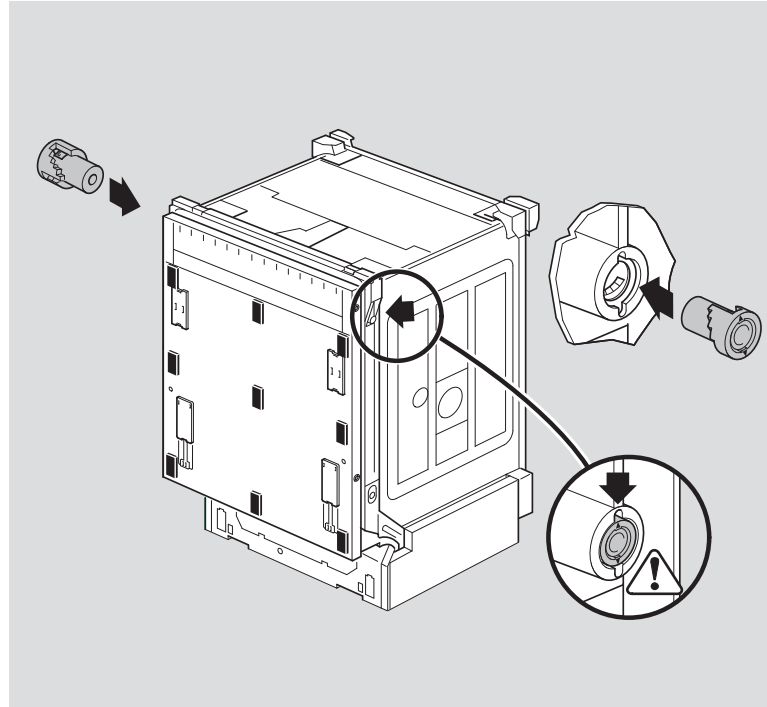
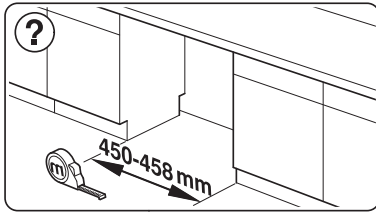

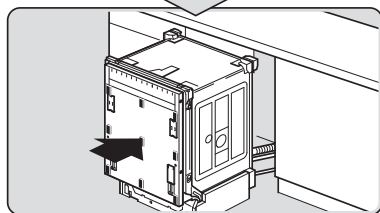
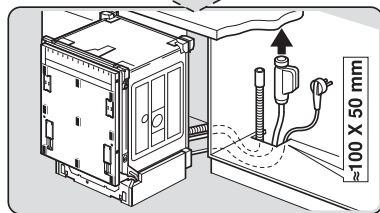
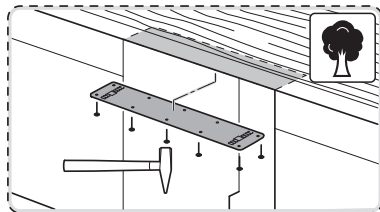
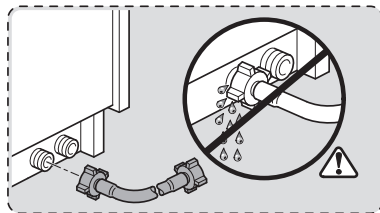

nicht einklemmen
do not pinch
ne pas coincer
No doblar

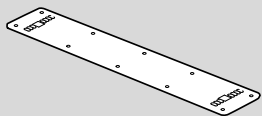
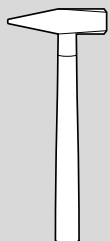
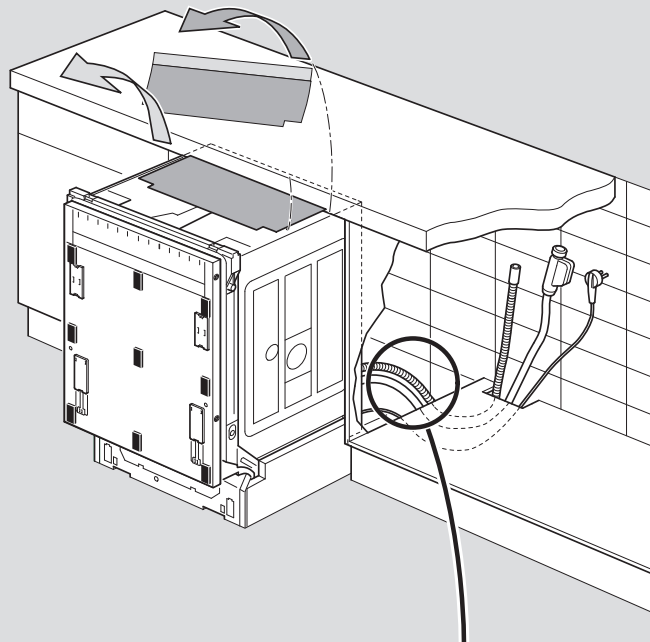
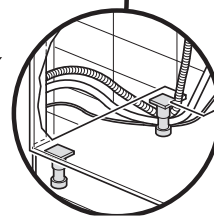

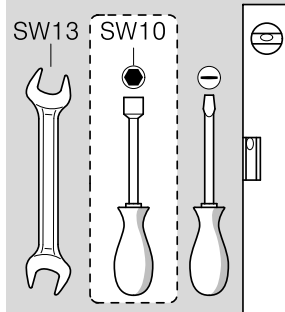
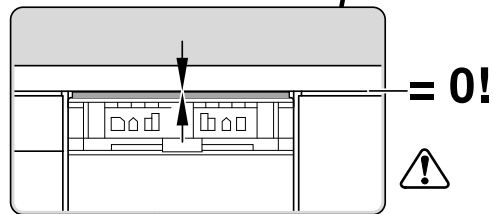
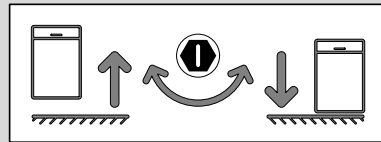
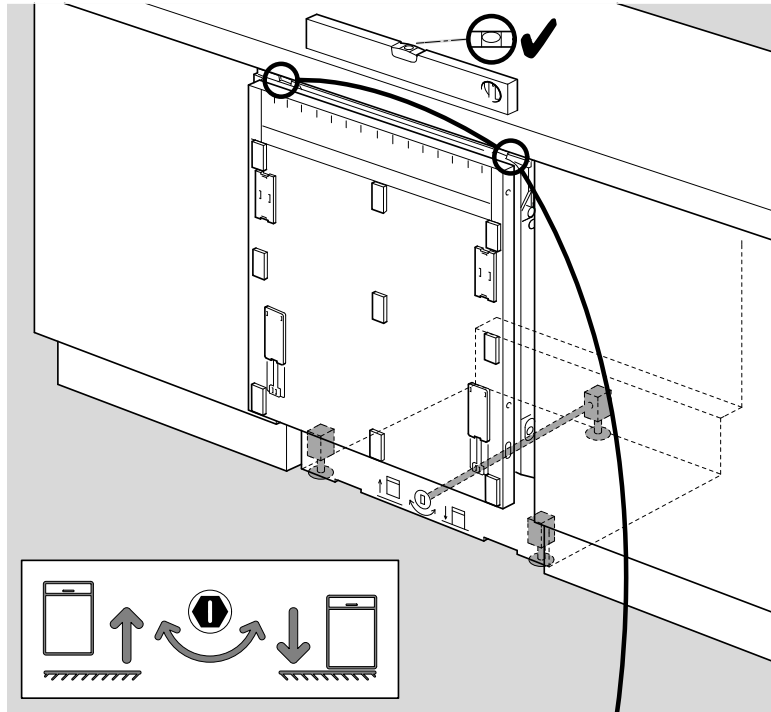
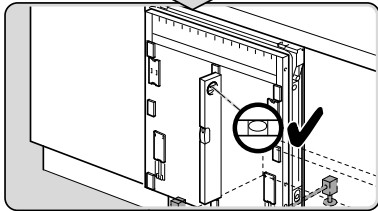
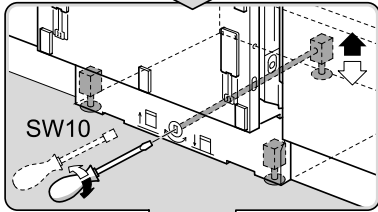
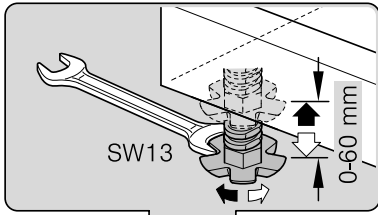

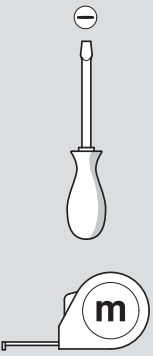
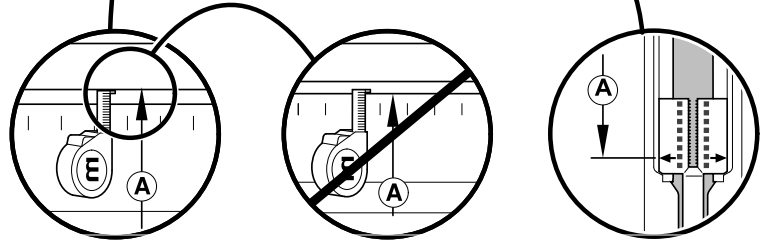
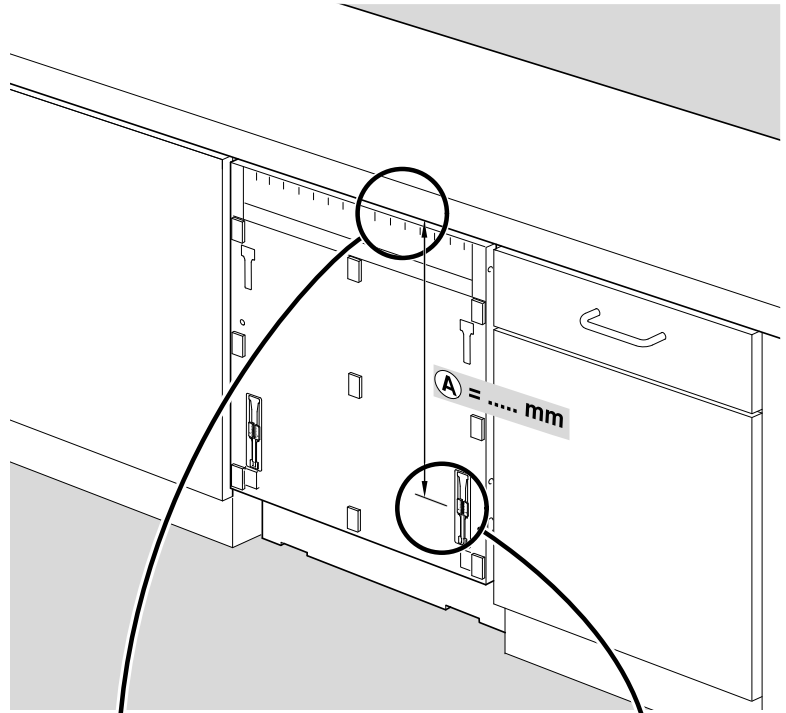

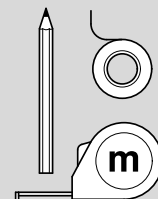
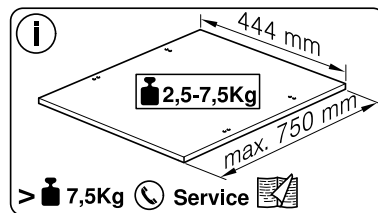
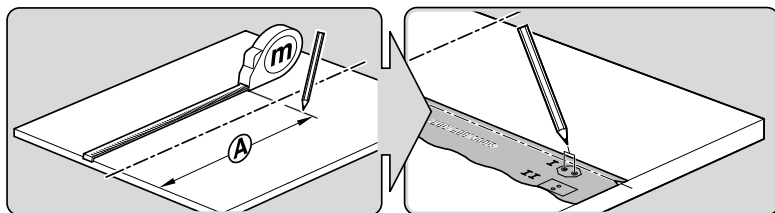
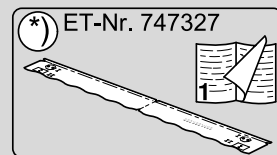
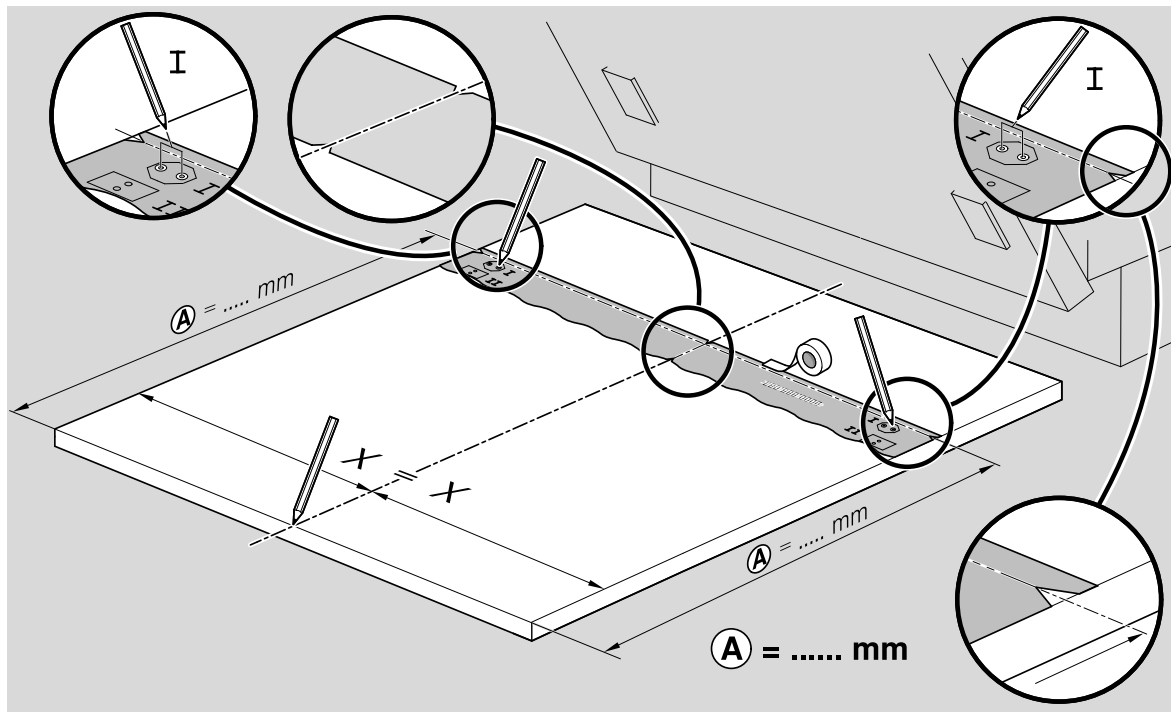

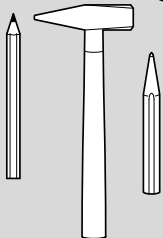
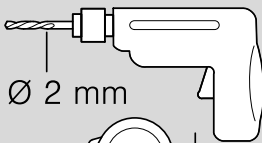
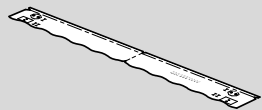
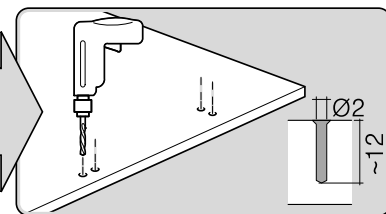
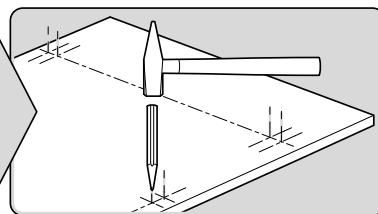
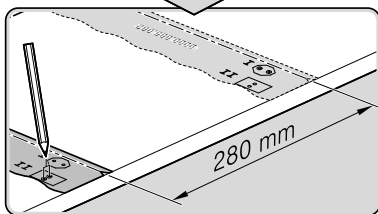
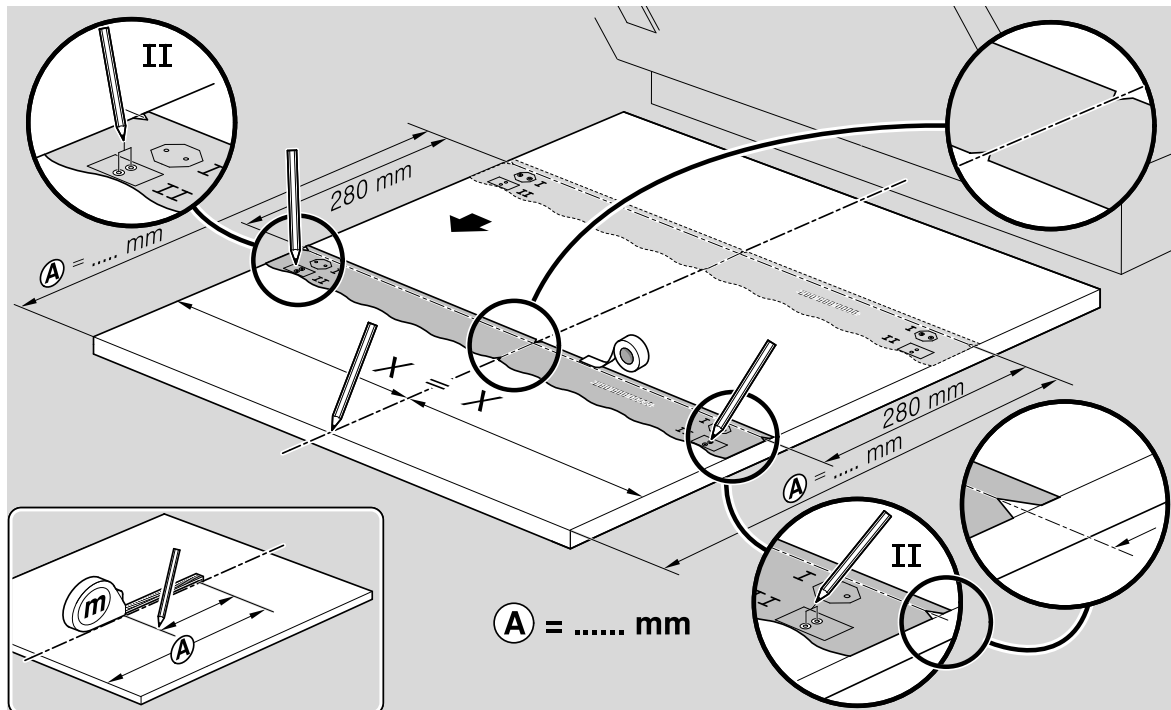

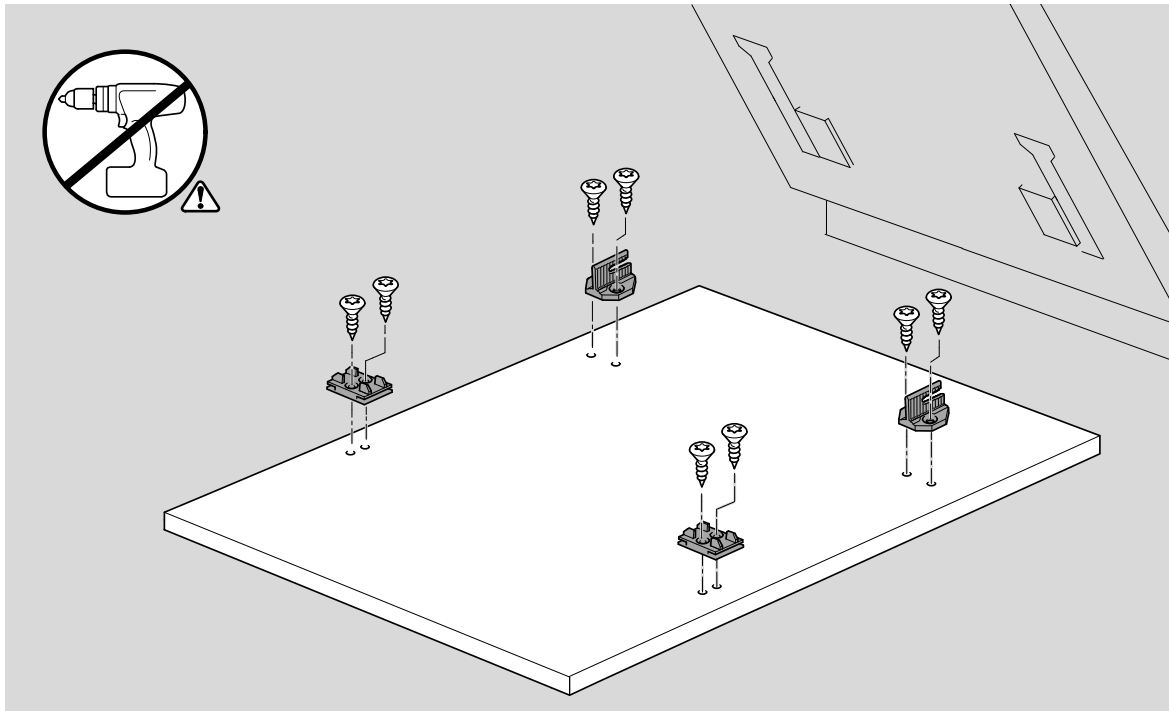

Ø4X13

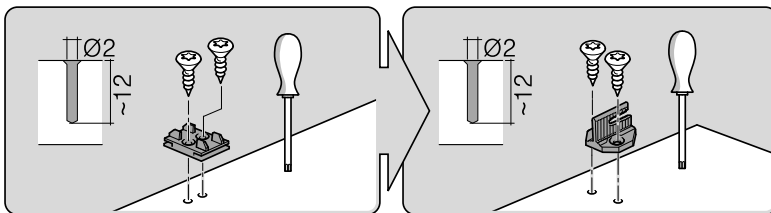
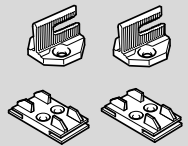
Torx
T 20

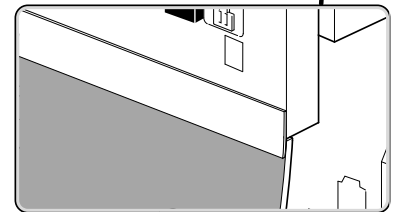
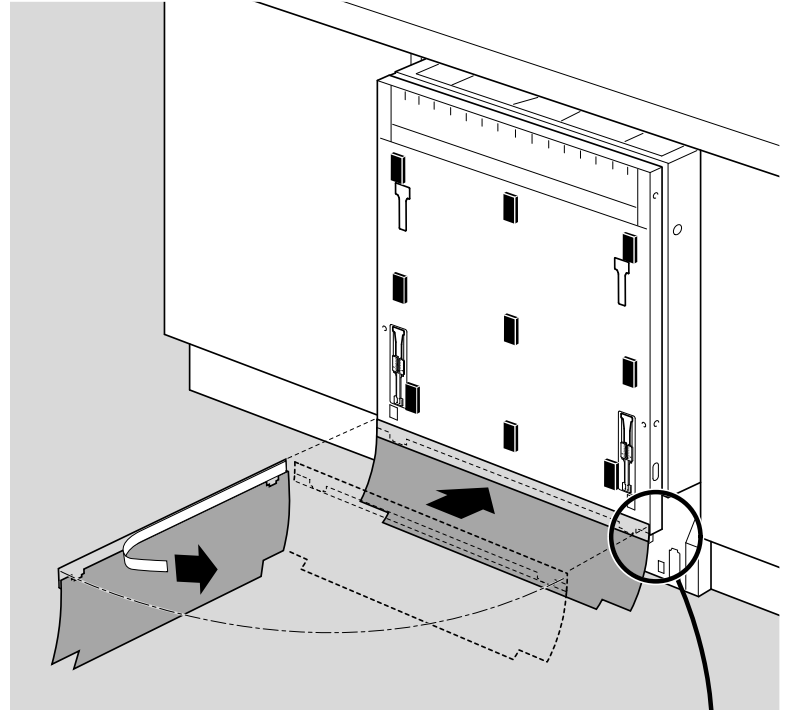
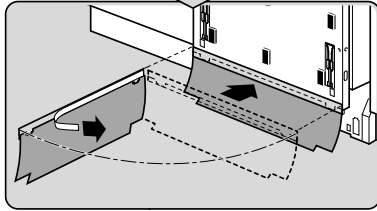
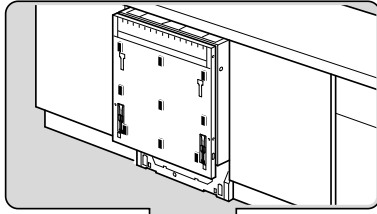

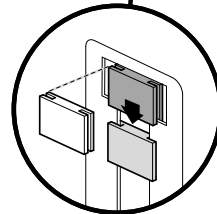
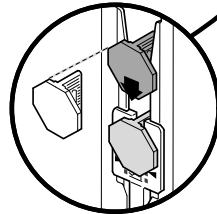
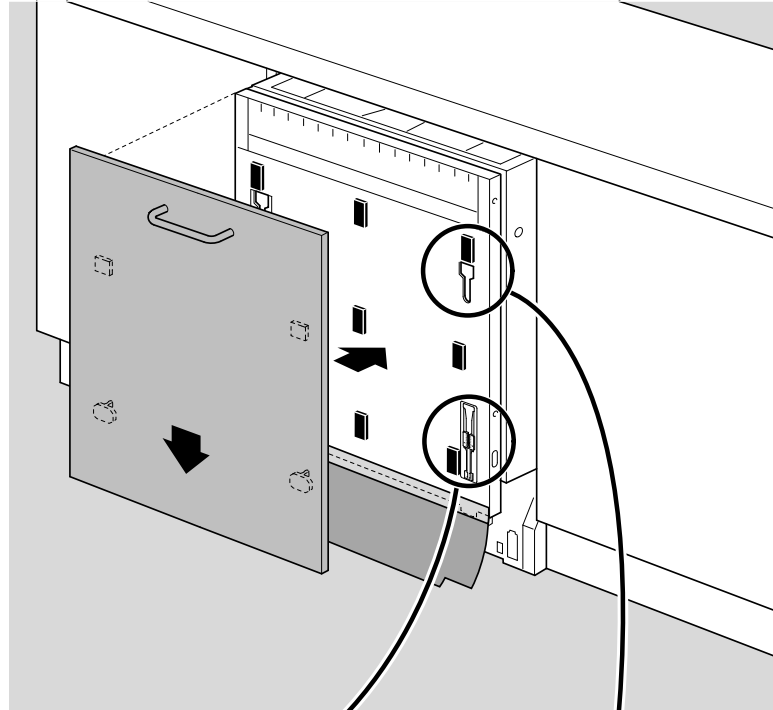
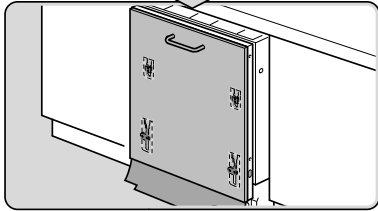
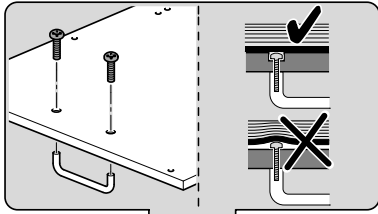

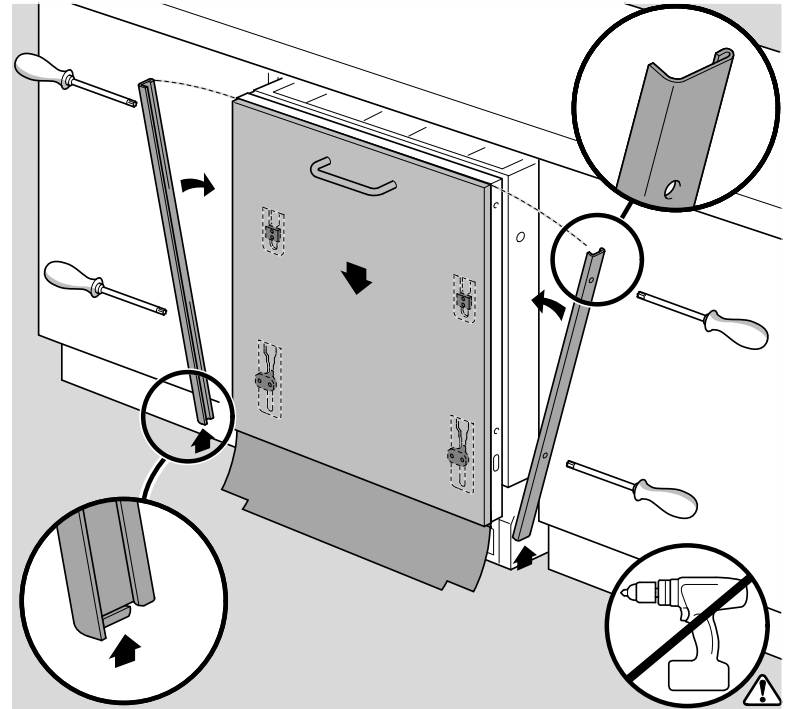
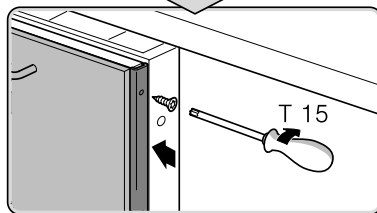
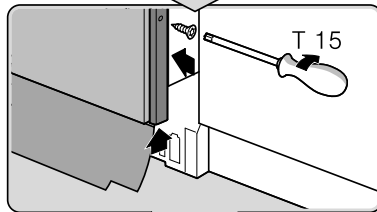
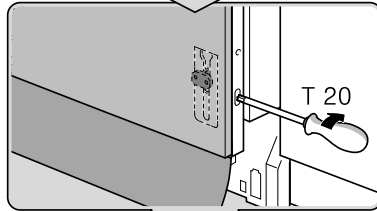
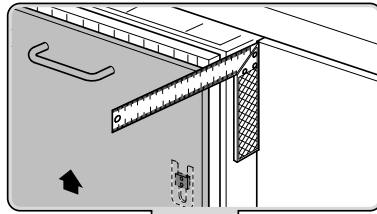

Torx
T 15

Torx
T 20

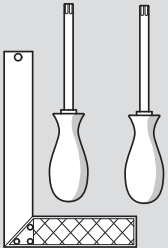

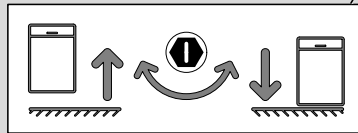
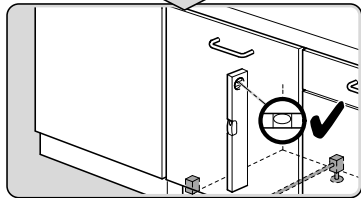
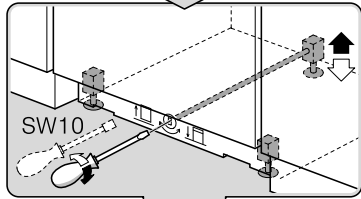
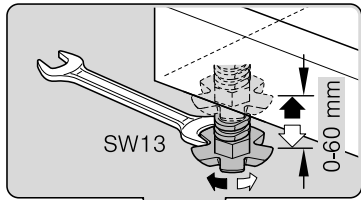

verspannen
brace
calar verticalement
Enrasar

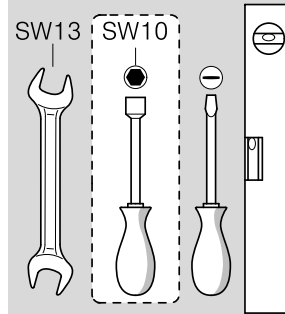
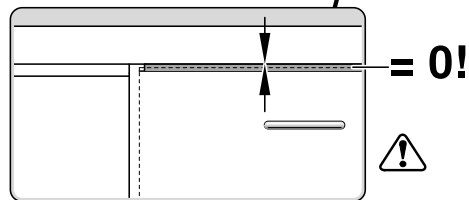



Ø4X30

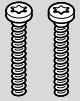

Torx
T 20

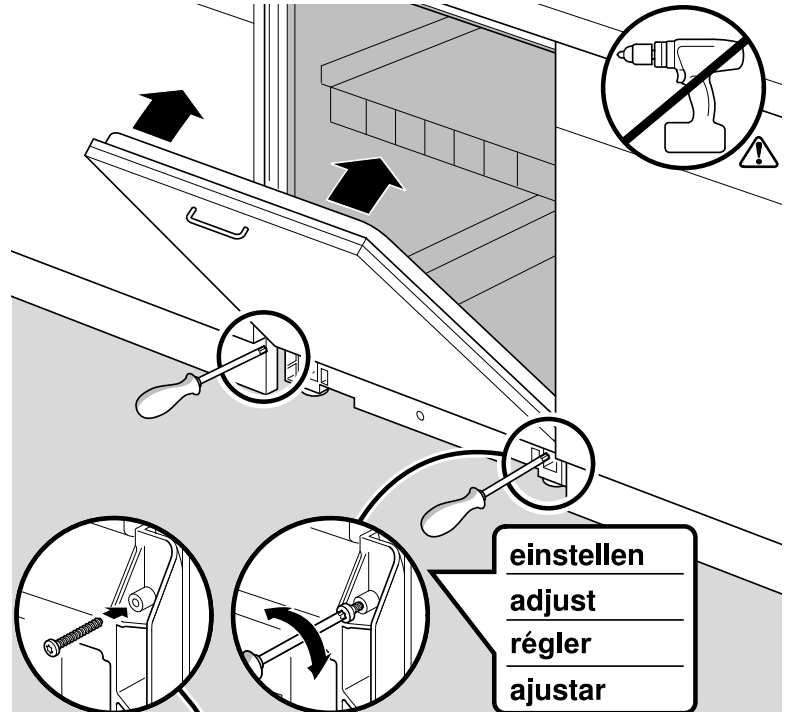
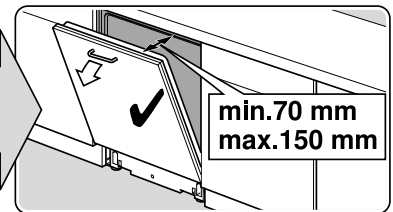
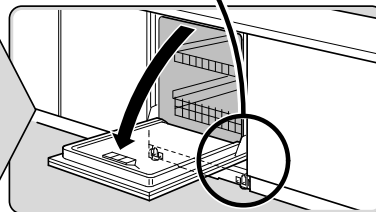
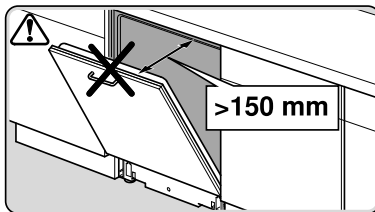
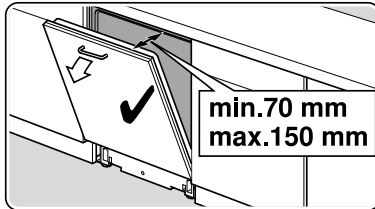

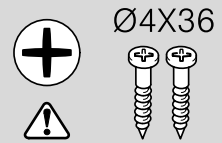
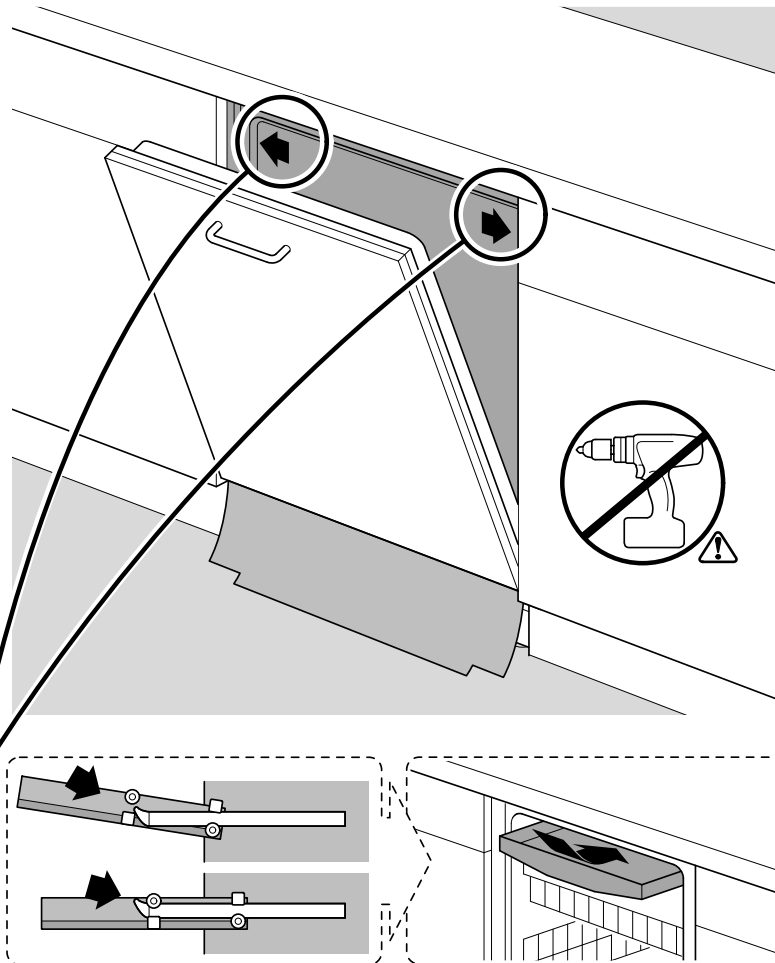
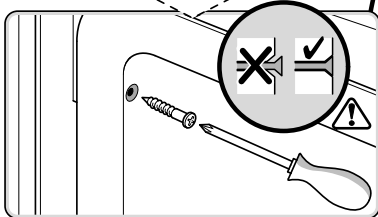
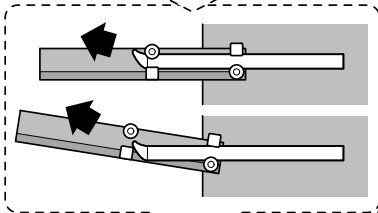
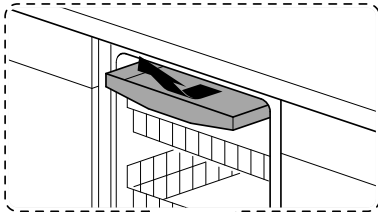
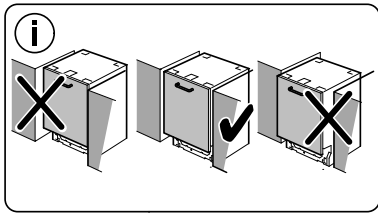

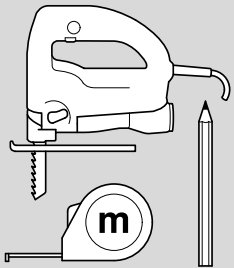
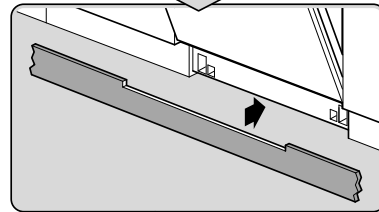
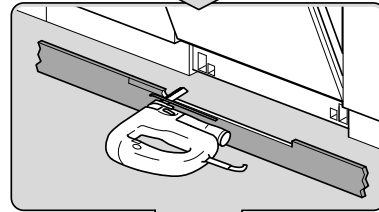
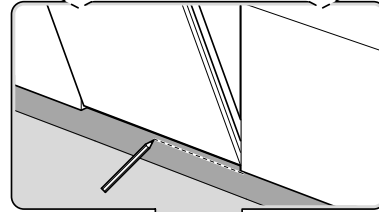
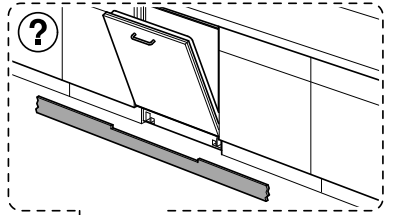
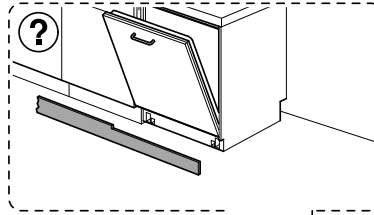
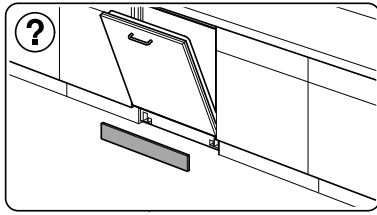

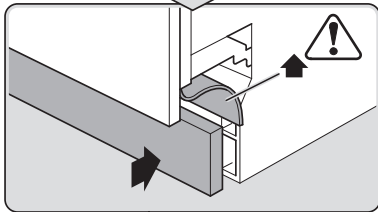
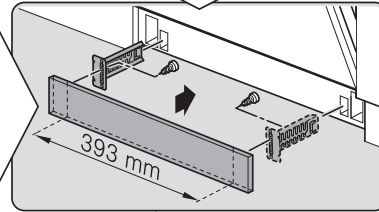
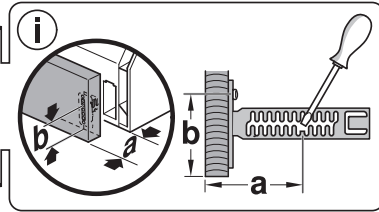
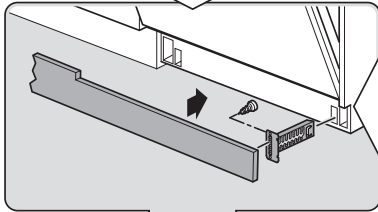
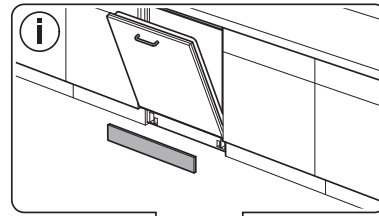
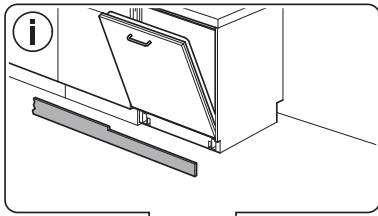

Ø4X13

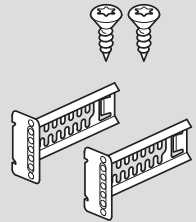

Torx
T 20



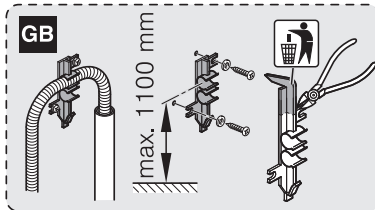
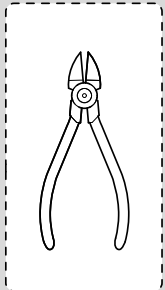
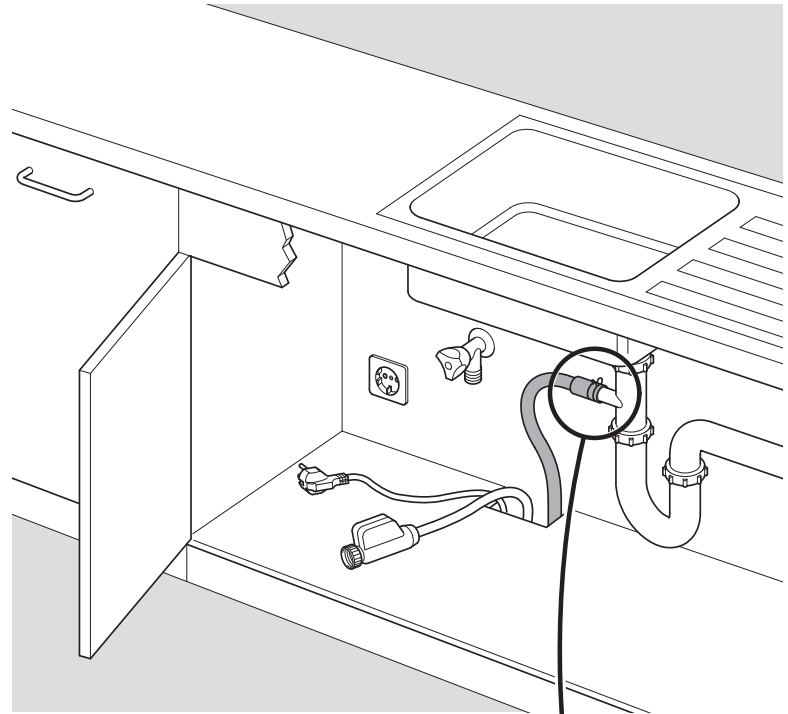
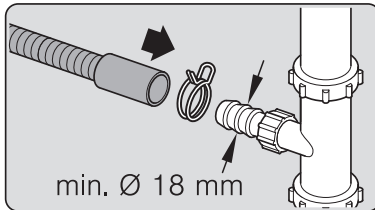
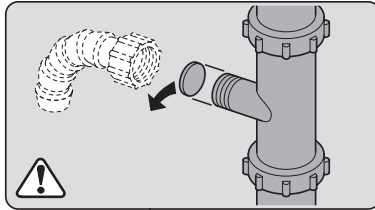
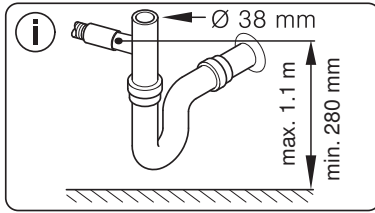

Dichtheit prüfen
Check for leaks
Verifiez l'étanchéité
Verificar la estanqueidad

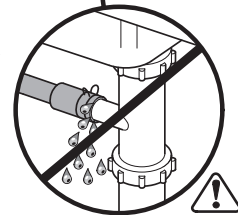



max. 10 Nm

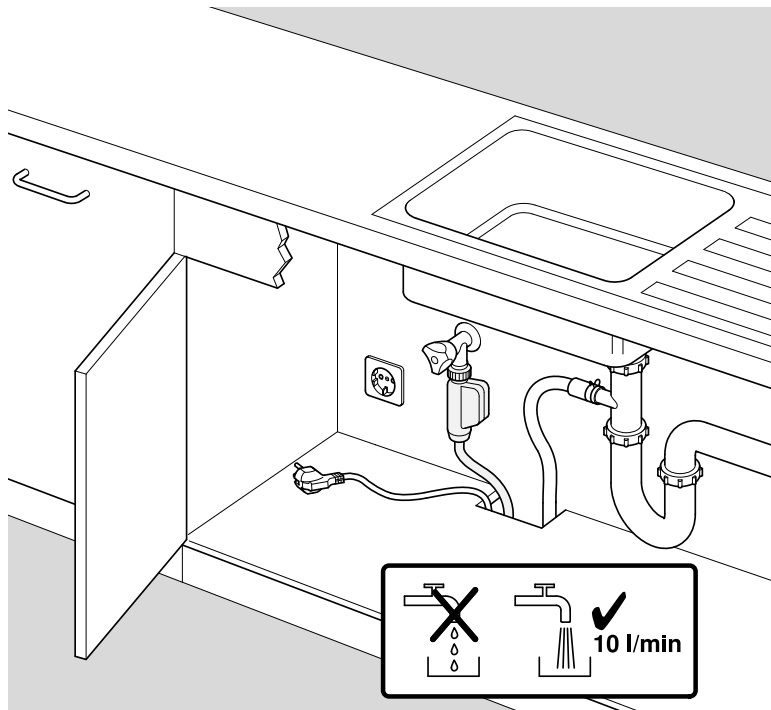

Dichtheit prüfen
 Check for leaks
 Verifiez l'étanchéité
 Verificar la estanqueidad



