



SIEMENS



Washing machine

WMH6Y790GB, WMH4Y790GB

siemens-home.com/welcome

en Instruction Manual and Installation Instructions

Register
your
product
online

Your new washing machine

You have chosen a Siemens washing machine.

Please take a few minutes to read and become familiar with the advantages of your washing machine.

To meet the high quality demands required by Siemens, every washing machine that leaves our factory is carefully checked to ensure that it functions correctly and is in perfect condition.

For more information on our products, accessories, replacement parts and services, see our website www.siemens-home.com or contact our after-sales service centres.

If the operating and installation instructions describe different models, any differences will be pointed out at the relevant points in the text.



Read these operating and installation instructions before switching on the washing machine.

Display rules

Warning!

This combination of symbol and signal word indicates a possibly dangerous situation. Not heeding the warning can cause death or injuries.

Caution!

This signal word indicates a possibly dangerous situation. Not heeding the caution can cause property and/or environmental damage.

Note/tip

Information about the optimum use of the appliance/any other useful information.











1. 2. 3. / a) b) c)











The steps are represented by numbers or letters.

■ / -

Lists are represented by a small box or a dash.

Contents

 Intended use	5	 Laundry	29
 Safety instructions	6	Prepare the laundry	29
Children/people/pets	6	Sorting laundry	29
Installation	7	 Detergent	30
Operation	10	Correct selection of detergent	30
Cleaning/Maintenance	11	Saving energy and detergent	30
 Environmental protection	13	 Overview of programmes	31
Packaging/used appliance	13	Programmes on the programme selector	31
Tips on economical use	13	Starching	37
 Positioning and connecting	14	Dyeing/bleaching	37
Included with the appliance	14	Memory (depending on the model)	37
Safety instructions	15	 Programme default settings	38
Installation surface	15	Temperature	38
Installation on a base or a wooden joist floor	15	Spin speed	38
Installation on a platform with drawer	15	Finish in	38
Installing the appliance in a kitchenette	16	 Additional programme settings/options (* depending on the model)	39
Removing the transport locks	16	speedPerfect 	39
Hose and cable lengths	17	ecoPerfect 	39
Water inlet	18	Prewash *	39
Water outlet	19	Extra Rinse *	39
Levelling	20	Water Plus *	39
Electrical connection	21	Less Ironing *	39
Before washing for the first time	22	Soak *	40
Transportation	23	Rinse Hold *	40
 Main points in brief	24	Silent Wash *	40
 Getting to know the appliance 25		ASR Stain Automatic 	41
Washing machine	25		
Control panel	26		
Display panel	27		

	Operating the appliance	42
	Preparing the washing machine	42
	Switching on the appliance/ selecting a programme	42
	Change the programme default settings	42
	Select additional programme settings	43
	Placing laundry into the drum	43
	Measure and add detergent and care products	44
	Start the programme	45
	Child Lock 3 sec.	46
	Adding laundry	46
	Changing the programme	46
	Cancel the programme	46
	Programme end during rinse hold.	47
	Programme end.	47
	Removing laundry/ switching off the appliance	47
	Home Connect	48
	Connecting to your home network automatically	48
	Connecting to your home network manually	49
	Connecting to the Home Connect app	50
	Switching Wi-Fi on and off	51
	Resetting your network settings.	51
	Updating the software	52
	About data protection	53
	Declaration of Conformity	53
	Appliance settings	54
	Sensors	55
	Automatic load sensing	55
	Unbalanced load detection system	55
	AquaSensor.	55
	Load sensor/display	55
	Dosing recommendation	55
	Cleaning and maintenance	56
	Machine housing/control panel	56
	Drum	56
	Descaling	56
	Detergent drawer and housing.	57
	The drain pump is blocked, emergency draining	57
	The drain hose at the siphon is blocked.	58
	Filter in the water supply blocked.	58
	Faults and what to do about them.	59
	Emergency release.	59
	Information on the display panel	60
	Faults and what to do about them.	61
	After-sales service	63
	Consumption rates.	64
	Energy and water consumption, programme duration and residual moisture for the main washing programmes.	64
	Efficiency test programmes for cotton fabrics	65
	Technical data.	65
	Aqua-Stop warranty	66



Intended use

- This appliance is intended for private domestic use only.
- Do not install or operate this appliance anywhere that is liable to experience frost and/or outdoor conditions. There is a risk that the appliance will be damaged if residual water in it freezes. If hoses freeze up, they may crack/burst.
- This appliance must only be used for washing domestic laundry, consisting of machine-washable items and hand-washable woollens (see label on item). Using the appliance for any other purpose is outside of the scope of its intended application and is forbidden.
- This appliance is suitable for operation with cold mains water and commercially available detergents and care products (must be suitable for use in washing machines).
- This appliance is intended for use up to a maximum height of 4000 metres above sea level.

Before you switch on the appliance:

Check that there is no visible damage to the appliance. Do not operate the appliance if it is damaged. Should you have any problems, please contact your specialist dealer or our customer service.

Read and follow the operating and installation instructions and all other information provided with this appliance.

Retain the documents for subsequent use or for subsequent owners.



Safety instructions

The following safety information and warnings are provided to protect you from injury and to prevent material damage to your surroundings.

It is nevertheless important to take the necessary precautions and to proceed with care when installing, maintaining, cleaning and operating the appliance.

Children/people/pets



Warning Risk of death!

Children and other people who are unable to assess the risks involved when using the appliance may injure themselves or may find themselves in life-threatening situations. Therefore please note:

- The appliance may be used by children over the age of 8 years and by persons with reduced physical, sensory or mental capacity or by persons with a lack of experience or knowledge as long as they are supervised or have received instruction on how to use the appliance safely and they have understood the potential risks of using the appliance.
- Children must not play with this appliance.

- Do not allow children to clean or maintain this appliance unsupervised.
- Keep children under 3 years and pets away from this appliance.
- Do not leave the appliance unattended when children or other people who are unable to assess the risks are in the vicinity.



Warning Risk of death!

Children may lock themselves inside appliances and find themselves in a life-threatening situation.

- Do not position the appliance behind a door, as this may obstruct the appliance door or prevent it from opening completely.
- Once an appliance has reached the end of its life, pull the mains plug from the socket **before** severing the mains cable, and then destroy the lock on the appliance door.

⚠ Warning**Risk of suffocation!**

If allowed to play with the packaging/plastic film or packing components, children may become caught in these or pull them over their heads and suffocate.

Keep packaging, plastic film and packing components away from children.

⚠ Warning**Risk of poisoning!**

Detergents and care products may result in poisoning if consumed.

If accidentally swallowed, seek medical advice. Keep detergents and care products out of the reach of children.

⚠ Warning**Risk of burns!**

When washing at high temperatures, the glass in the appliance door becomes hot. Stop children from touching the appliance door when it is hot.

⚠ Warning**Eye/skin irritation!**

Contact with detergents or care products may cause eye/skin irritation.

Rinse eyes/skin thoroughly if they/it come(s) into contact with detergents or care products. Keep detergents and care products out of the reach of children.

Installation**⚠ Warning****Risk of electric shock/fire/material damage/damage to the appliance!**

If the appliance is not installed properly, this may lead to a dangerous situation. Make sure that:

- The mains voltage on your power socket matches the rated voltage specified on the appliance (identification plate). The connected loads and the required fuse protection are specified on the identification plate.
- The appliance is only connected to a source of alternating current via a nationally recognized and grounded outlet that has been correctly installed.
- The mains plug and the grounded socket match and the earthing system has been correctly installed.
- The cross section of the cable is sufficiently large enough.
- The mains plug is accessible at all times.
- If using a residual current circuit breaker, only use one that bears the following mark: . The presence of this mark is the only way to be sure that it fulfils all the applicable regulations.

⚠ Warning

**Risk of electric shock/fire/
material damage/damage to
the appliance!**

If the appliance's mains cable is altered or damaged, this may result in electric shock, short circuiting or fire due to overheating.

The mains cable must not be kinked, crushed or altered, and must not come into contact with any heat sources.

⚠ Warning

**Risk of fire/material damage/
damage to the appliance!**

The use of extension cords or power strips may result in fire due to overheating or short circuiting.

Connect the appliance directly to an earthed socket that has been correctly installed. Do not use extension cords, power strips or multi-way couplers.

⚠ Warning

**Risk of injury/material
damage/damage to the
appliance!**

- The appliance may vibrate or move when in operation, potentially resulting in injury or material damage.
Place the appliance on a clean, even, solid surface and, using a spirit level to guide you, level it with the screw-in feet.

- If you take hold of any of the appliance's protruding parts (e.g. the appliance door) in order to lift or move it, these parts may break off and cause injury.

Do not take hold of any of the appliance's protruding parts in order to move the appliance.

⚠ Warning

Risk of injury!

- The appliance is very heavy. Lifting it may result in injury. Do not lift the appliance on your own.
- The appliance has sharp edges on which you could cut your hands. Do not take hold of the appliance by its sharp edges. Wear protective gloves to lift it.
- If the hoses and mains cables are not correctly routed, they may constitute a tripping hazard, which may result in injury. Route hoses and cables such that they do not constitute a tripping hazard.

Caution!**Material damage/damage to the appliance**

- If the water pressure is too high or too low, the appliance may not be able to operate properly, and it may also result in material damage or damage to the appliance.
Make sure that the water pressure in the water supply facility is at least 100 kPa (1 bar), and does not exceed 1000 kPa (10 bar).
- If the water hoses are altered or damaged, this may result in material damage or damage to the appliance. The water hoses must not be kinked, crushed, altered or severed.
- The use of hoses supplied by other brands to connect to the water supply may result in material damage or damage to the appliance. Use the hoses supplied with the appliance or genuine spare part hoses only.
- The appliance is secured for transportation by transport locking devices. If the transport locking devices are not removed before the appliance is operated, this may result in damage to the appliance.
It is important to completely remove all transport locking devices before using the appliance for the first time. Make sure that you retain these transport locking devices separately. It is important to refit the transport locking devices if the appliance is to be transported, in order to prevent the appliance from being damaged in transit.

Operation

Warning

Risk of explosions/fire!

Laundry that has been pretreated with cleaning agents that contain solvents, e.g. stain remover/cleaning solvent, may cause an explosion in the drum. Rinse the laundry thoroughly with water before washing it in the machine.

Warning

Risk of poisoning!

Poisonous fumes may be given off by cleaning agents that contain solvents, e.g. cleaning solvent.

Do not use cleaning agents that contain solvents.

Warning

Risk of injury!

- If you support your weight/sit on the appliance door when it is open, the appliance may tip over, which may result in injury.

Do not support your weight on the appliance door when it is open.

- If you climb onto the appliance, the worktop may break, which may result in injury.

Do not climb onto the appliance.

- If you reach into the drum while it is still rotating, you risk injuring your hands. Wait until the drum has stopped rotating.

Warning

Risk of scalding!

When washing at high temperatures, there is a risk of scalding if you come into contact with hot detergent solution (e.g. when draining hot detergent solution into a washbasin).

Do not reach into the hot detergent solution.

Warning

Eye/skin irritation!

Detergent and care products may spray out if the detergent drawer is opened while the appliance is in operation.

Rinse eyes/skin thoroughly if they/it come(s) into contact with detergents or care products. If accidentally swallowed, seek medical advice.

Caution!**Material damage/damage to the appliance**

- If the amount of laundry in the appliance exceeds its maximum load capacity, it may not be able to operate properly, or this may result in material damage or damage to the appliance.
Do not exceed the maximum load capacity of dry laundry. Make sure you comply with the maximum load capacities specified for each of the programs. → *Page 31*
- If you pour the wrong quantity of detergent or cleaning agent into the appliance, this may result in material damage or damage to the appliance.
Use detergents/care products/cleaning agents and softeners in accordance with the manufacturers' instructions.

Cleaning/Maintenance** Warning****Danger of death!**

The appliance is powered by electricity. There is a risk of electric shock if you come into contact with live components. Therefore please note:

- Switch off the appliance. Disconnect the appliance from the power supply (pull out the plug).
- Never take hold of the mains plug with wet hands.
- When removing the mains plug from the socket, always take hold of the plug itself and never the mains cable, otherwise this may damage the mains cable.
- Do not make any technical modifications to the appliance or its features.
- Repairs and any other work on the appliance must only be conducted by our customer service or by an electrician. The same applies for replacing the mains cable (when necessary).
- Spare mains cables can be ordered from our customer service.

 **Warning**

Risk of poisoning!

Poisonous fumes may be given off by cleaning agents that contain solvents, e.g. cleaning solvent.

Do not use cleaning agents that contain solvents.

 **Warning**

Risk of electric shock/material damage/damage to the appliance!

If moisture penetrates the appliance, this may cause it to short circuit.

Do not use a pressure washer or steam cleaner to clean your appliance.

 **Warning**

Risk of injury/material damage/damage to the appliance!

The use of spare parts and accessories supplied by other brands is dangerous and may result in injury, material damage or damage to the appliance.

For safety reasons, use genuine spare parts and accessories only.

Caution!

Material damage/damage to the appliance

Cleaning agents and agents for pretreating laundry (e.g. stain removers, prewash sprays, etc.) may cause damage if they come into contact with the surfaces of the appliance. Therefore please note:

- Do not allow these agents to come into contact with the surfaces of the appliance.
- Clean the appliance with nothing but water and a soft, damp cloth.
- Remove any detergent, spray or other residues immediately.



Environmental protection

Packaging/used appliance



Dispose of packaging in an environmentally-responsible manner.

This appliance is labelled in accordance with European Directive 2012/19/EU concerning used electrical and electronic appliances (waste electrical and electronic equipment - WEEE).

The guideline determines the framework for the return and recycling of used appliances as applicable throughout the EU.

Tips on economical use

- Always fill the appliance with the maximum amount of laundry for each programme.
→ "📄 Overview of programmes" on page 31
- Wash normally soiled laundry without prewash.
- For light and normal soiling in laundry, you can save energy and detergent. → Page 30
- The selectable temperatures apply to the care labels on the textiles. The temperatures in the machine may deviate from this so that you get the optimum mix of energy-saving and washing results.

- **Information on energy and water consumption:** → Page 27
The displays provide information about the relative level of energy and water consumption in the selected programmes.

The more display segments are visible, the higher the respective consumption.

This enables you to compare the consumption levels of the different programmes when choosing your programme settings and decide on an energy- and water-saving programme setting.

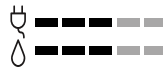

- 🚰 Energy consumption
- 💧 Water consumption

- **Energy-saving mode:** The display panel lighting goes out after a few minutes and the ▶|| button flashes. Press any button to activate the lighting.
Energy-saving mode is not activated if a programme is running.
- **Automatic switch off:** If the appliance is not operated for a prolonged period, it may automatically switch off before the programme starts and when the programme has ended to save energy. Press the main switch again to switch on the appliance.
→ "📄 Appliance settings" on page 54
- If the washing will be dried in a dryer, select the spin speed according to the dryer manufacturer's instructions.



Positioning and connecting

Included with the appliance

Note: Check the machine for transport damage. Never use a damaged machine. If you have any complaints, contact the dealer from whom you purchased the appliance or our customer services. → Page 63

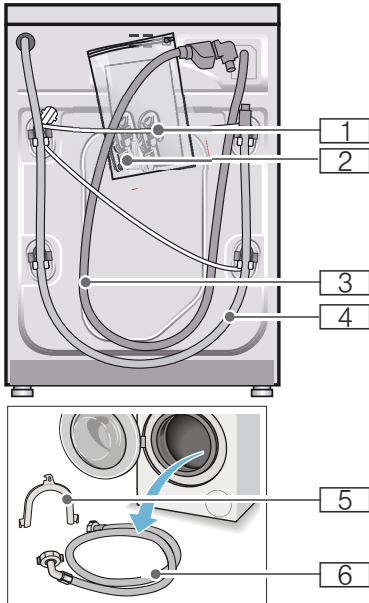

- 1 Mains cable
 - 2 Bag:
 - Installation and operating instructions
 - Customer services location directory*
 - Warranty*
 - Cover caps for openings after the transport braces have been removed
 - Adaptor with sealing washer from 21 mm = 1/2" to 26.4 mm = 3/4" *
 - 3 Water supply hose on Aqua-Stop models
 - 4 Water drain hose
 - 5 Elbow for securing the water drain hose*
 - 6 Water supply hose on standard/Aqua-Secure models
- * depending on the model

In addition, a hose clamp (24 - 40 mm diameter, available from specialist dealers) is required to connect the water drain hose to a siphon.

Useful tools

- Spirit level for aligning
- Spanner with:
 - WAF13 for loosening the transport braces, and
 - WAF17 for aligning the appliance feet

Safety instructions

Warning

Risk of injury!

- The washing machine is very heavy. Be careful when lifting/transporting the washing machine.
- When the washing machine is lifted by its protruding parts (e.g. the washing machine door), the components may break off and cause injuries. Do not lift the washing machine by protruding parts.
- If the hose and mains cables are not routed properly, there is a risk of tripping and injury. Lay hoses and cables in such a way that there is no risk of tripping.

Caution!

Damage to the appliance

Frozen hoses may rip/burst. Do not install the washing machine in areas exposed to frost or outdoors.

Caution!

Water damage

The connection points for the water supply hose and water drain hose are under high water pressure. To prevent leaks and water damage, you must follow the instructions in this section.

Notes

- In addition to the safety information listed here, the local water and electricity supplier may have special requirements.
- If in doubt, have the appliance connected by a specialist.

Installation surface

Note: The washing machine be stable so that it does not move around.

- The installation surface must be firm and level.
- Soft floors/floor coverings are not suitable.

Installation on a base or a wooden joist floor

Caution!

Damage to the appliance

The washing machine may "wander" and tip/topple from the base when spinning.

The feet of the appliance must be secured with holding brackets. Order no. WMZ 2200, WX 9756, Z 7080X0

Note: On wooden joist floors, install the washing machine:

- In a corner, if possible,
- On a water-resistant wooden board (min. 30 mm thick) which is screwed tightly to the floor.

Installation on a platform with drawer

Platform order no.: WMZ 20490, WZ 20490, WZ 20510, WZ 20520

Installing the appliance in a kitchenette

Warning **Danger of death!**

There is a risk of electric shock if you touch live components. Do not remove the appliance covering plate.

Notes

- Recess width of 60 cm required.
- Only install the washing machine underneath a continuous worktop that is securely connected to adjacent cabinets.

Removing the transport locks

Caution! **Damage to the appliance**

- The machine is secured for transportation using transport locks. If the transport locks are not removed, the drum, for example, may become damaged when the machine is operated. Before using the appliance for the first time, make sure that you completely remove all four transport locks. Keep the locks in a safe place.
- To prevent transport damage from occurring if the appliance is moved at a later date, you must refit the transport locks before transporting the appliance.

Note: Keep the screws and sleeves in a safe place.

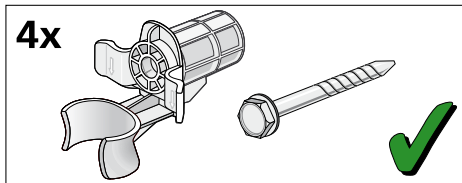

1. Take the hoses out of the holders.

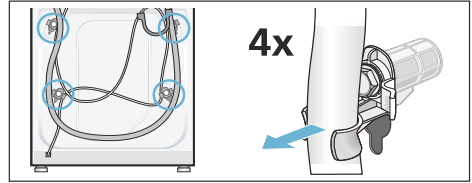

2. Unscrew and remove all four transportation securing bolts with a wrench (WAF 13). Remove the sleeves. Remove the mains cable from the holders.

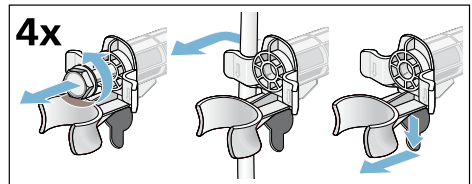

3. Insert the covers. Lock the covers firmly in place by applying pressure to the snap-in hooks.

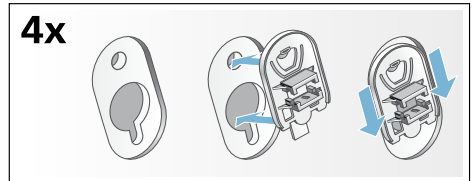

Hose and cable lengths

■ Left-hand connection

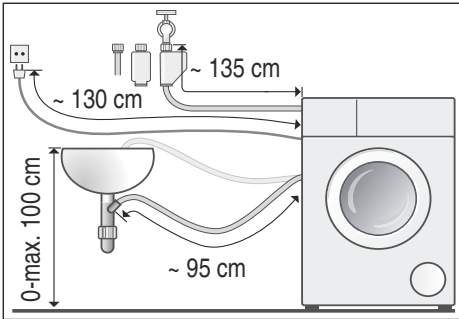

■ Right-hand connection

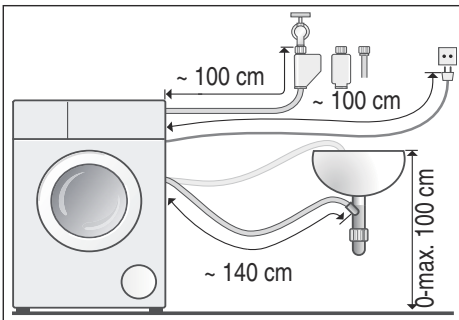

Tip: The following are available from specialist dealers/customer services:

- Extension for Aqua-Stop and cold water supply hose (approx. 2.50 m); order no. WM Z2380, WZ 10130, CZ 11350, Z 7070X0
- A longer supply hose (approx. 2.20 m) for standard models; individual component number for customer services: 00353925

Water inlet

Warning **Danger of death!**

There is a risk of electric shock if you touch live components. Do not immerse the Aqua-Stop safety valve in water (it contains an electric valve).

Notes

- Only operate the washing machine using cold mains water.
 - Do not connect the machine to the mixer tap of an unpressurised hot-water boiler.
 - Do not use a used supply hose. Only use the supply hose supplied or one that was purchased from an authorised specialist retailer.
 - Do not kink or squash the water supply hose.
 - Do not alter (shorten, cut through) the water supply hose (otherwise its strength is no longer guaranteed).
 - Only tighten the screw connections by hand. If the screw connections are tightened too much with a tool (pliers), the thread may become damaged.
 - When connecting to a 21 mm = 1/2" tap, first fit an adapter* with a sealing washer from 21 mm = 1/2" to 26.4 mm = 3/4".
- *supplied depending on the model

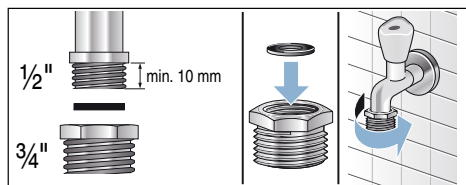

Optimum water pressure in the supply network

At least 100 kPa (1 bar)

Maximum 1000 kPa (10 bar)

When the tap is open, the water flow rate is at least 8 l/min.

If the water pressure is higher than this, a pressure-reducing valve must be installed.

Connection

Connect the water supply hose to the tap (26.4 mm = 3/4") and to the appliance (not necessary for Aqua-Stop models as this is permanently installed):

- Model: **Standard**

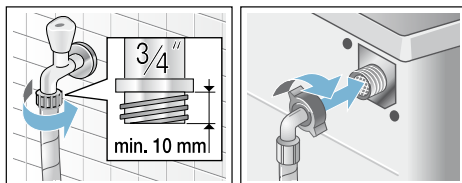

- Model: **Aqua-Secure**

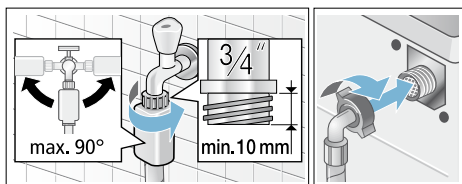

- Model: **Aqua-Stop**

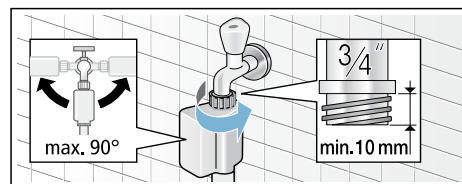

Note: Turn on the tap carefully, checking the leak tightness of the connection points. The screw connection is under mains water pressure.

Water outlet

Warning

Risk of scalding!

When you are washing at high temperatures, there is a risk of scalding if you come into contact with hot water (e.g. when draining hot water into a washbasin).

Do not reach into the hot water.

Caution!

Water damage

If the drain hose slips out of the washbasin or the connection point during draining due to high water pressure, any escaping water may cause water damage.

Secure the drain hose so that it cannot slip out.

Caution!

Damage to the appliance/fabrics

If the end of the drain hose is immersed in the drained water, water may be sucked back into the appliance and may damage the appliance/fabrics.

Make sure that:

- The plug does not block drainage from the washbasin.
- The end of the drain hose is not immersed in the drained water.
- The water drains away quickly enough.

Note: Do not kink the water drain hose or put strain on it lengthways.

Connection

■ Drainage into a washbasin

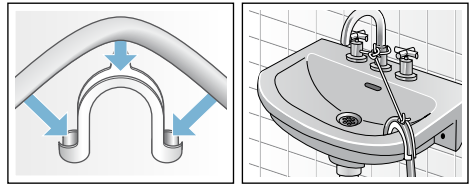

■ Drainage into a siphon

The connection point must be secured using a hose clamp with a diameter of 24 - 40 mm (available from specialist dealers).

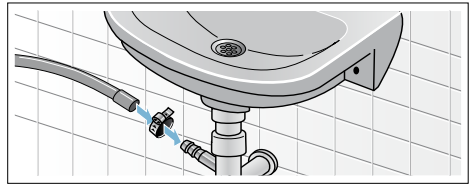

■ Drainage into a plastic pipe with rubber bushing or into a drainage pit

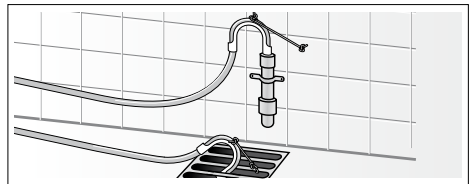

Levelling

Align the appliance using a spirit level.

Incorrect alignment may result in loud noises, vibrations and machine "movement".

1. Loosen the lock nuts using a WAF17 spanner, by turning it in a clockwise direction.
2. Check the alignment of the washing machine with a spirit level, and adjust it if necessary. Change the height by turning the appliance feet. All four appliance feet must stand firmly on the ground.
3. The lock nuts on all four appliance feet must be screwed tightly against the housing using a suitable WAF17 spanner. In doing so, hold the foot tight and do not adjust its height.



Electrical connection

Warning

Danger of death!

There is a risk of electric shock if you touch live components.

- Never touch or hold the mains plug with wet hands.
- Only pull out the mains cable by the plug and never by the cable, as this could damage it.
- Never unplug the mains plug during operation.

Observe the following information and ensure that:

Notes

- The mains voltage and voltage indicated on the washing machine (rating plate) are the same. The connected load and fuse required are specified on the rating plate.
- The washing machine is only connected to an alternating current supply via a properly installed earthed socket.
- The mains plug fits the socket.
- The cable cross-section is adequate.
- The earthing system is properly installed.
- The mains cable is only replaced by a qualified electrician (if this is necessary). Replacement mains cables are available from customer services.
- No multiple plugs/couplings or extension cables are used.
- If an earth-leakage circuit breaker is used, only a type which displays the  symbol is used. Only this symbol guarantees compliance with the currently applicable regulations.

- The mains plug can be accessed at all times.
- The mains cable is not kinked, squashed, altered or cut through.
- The mains cable does not come into contact with heat sources.

Before washing for the first time

The washing machine was thoroughly tested before leaving the factory. To remove any water that may be left over from the test, run the first wash cycle **without** any laundry.

Notes

- The washing machine **must be correctly installed** and **connected**.
From → *Page 14*
- Never use a machine if it is damaged. Inform the after-sales service.

Preparatory work:

1. Check the machine.
2. Remove the protective film from the control panel.
3. Plug in the mains plug.
4. Turn on the tap.

Running the programme without laundry:

1. Switch on the appliance.
2. Close the door (do not load any laundry).
3. Set the **Drum Clean 90 °C** programme.
4. Open the detergent drawer.
5. Pour approximately 1 litre of water into compartment **II**.
6. Pour standard washing powder into compartment **II**.
Note: To prevent foaming, only use half the amount of detergent recommended by the detergent manufacturer. Do not use detergents intended for woollens or delicates.
7. Close the detergent drawer.
8. Press the ►|| button.
9. Switch off the appliance at the end of the programme.

Your washing machine is now ready to use.

Transportation

E.g. when moving house

Preparatory work:

1. Turn off the tap.
2. Reduce the water pressure in the supply hose: → *Page 58*; Cleaning and maintenance – filter in the water supply blocked
3. Disconnect the washing machine from the mains.
4. Drain the remaining water: → *Page 57*; cleaning and maintenance – the drain pump is blocked, emergency draining
5. Remove the hoses.

Fitting the transportation securing means:

1. Remove the covers and keep them in a safe place.
If required, use a screwdriver.

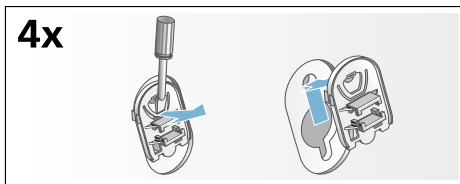

2. Insert all four sleeves.
Clip the mains cable securely in the holders. Insert the transportation securing bolts and tighten them with a wrench (WAF 13).

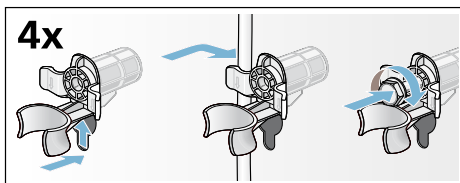

Before switching on the appliance again:

Notes

- The transport braces **must** be removed.
- Pour approx. 1 litre of water into compartment **II**, select the **Drain** programme and start.
This will prevent detergent from flowing unused into the drain during the next wash.

Main points in brief

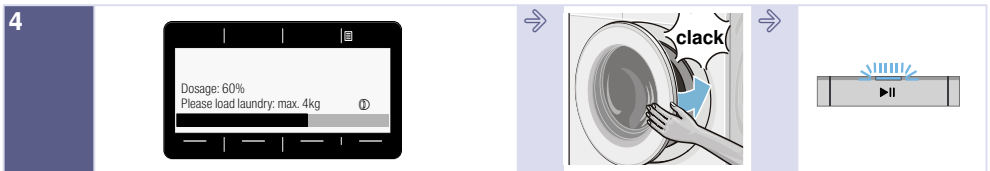
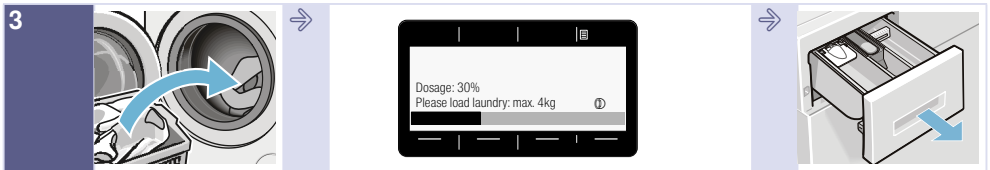
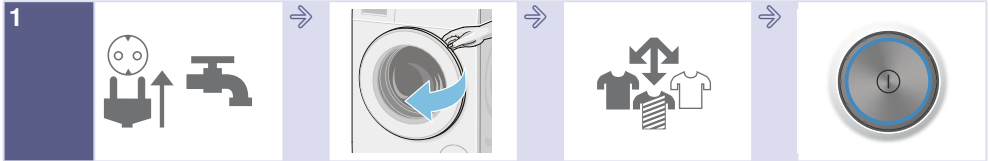

 Getting to know the appliance

Washing machine

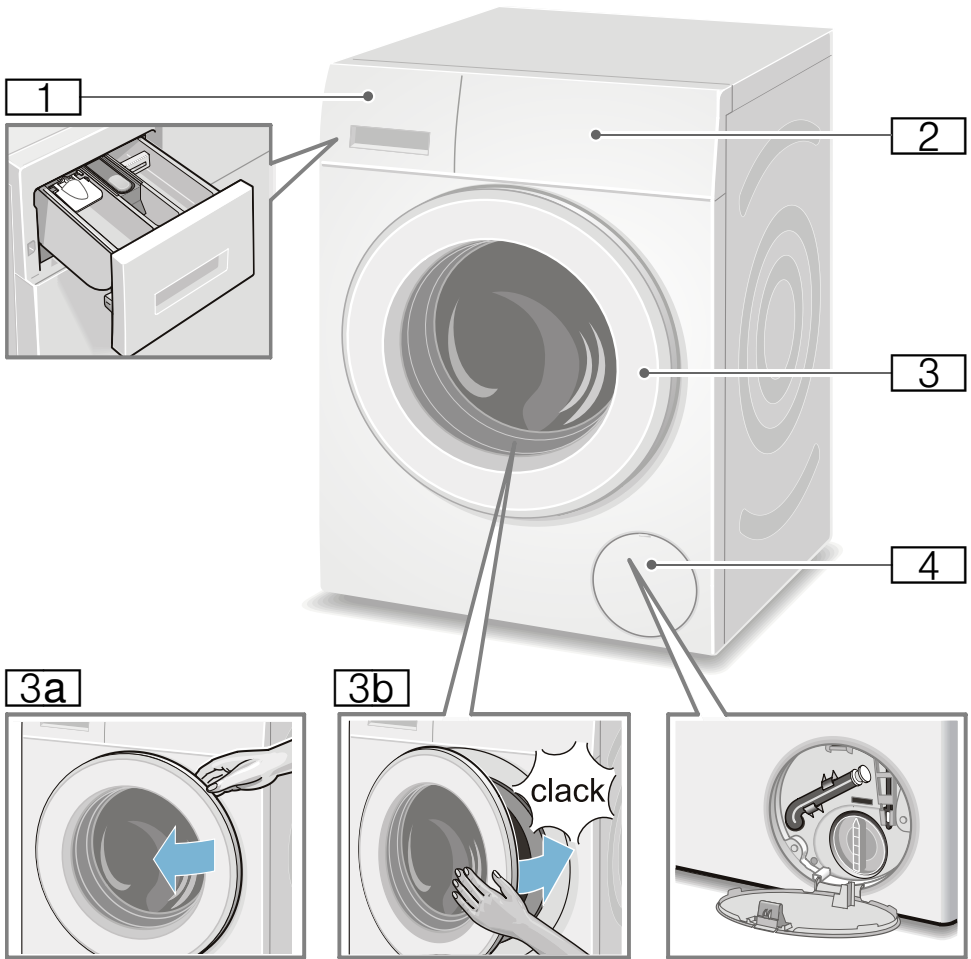



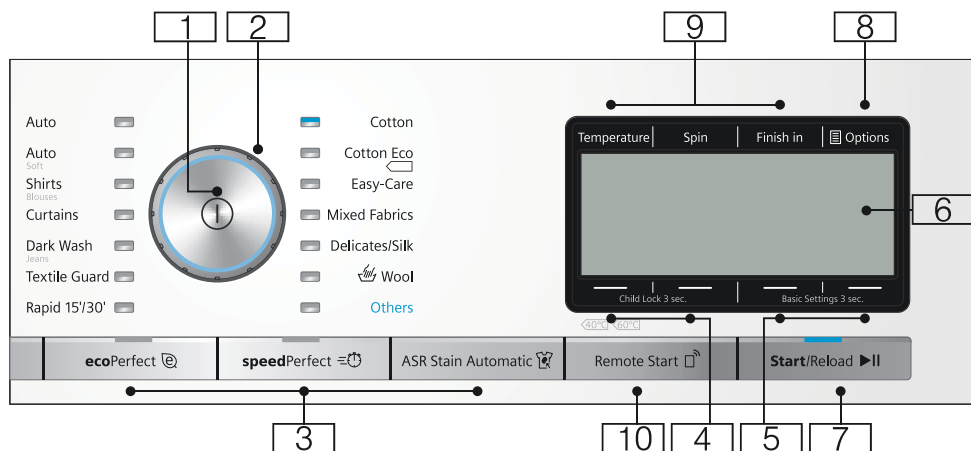

- 1** Detergent drawer → Page 44
- 2** Operating/display panel
- 3** Door with door handle
- 3a** Open the door
- 3b** Close the door
- 4** Service flap

Control panel



Note: All the buttons are sensitive (except for the main switch) and only need to be pressed lightly.

- 1 Main switch**
To switch the appliance on/off: Press the ① button.
- 2 Programme selector**
For selecting a programme. The programme selector can be turned in either direction. Programme overview → Page 31
- 3 Buttons for selecting additional programme settings:**
ecoPerfect , speedPerfect , ASR Stain Automatic 
- 4 Buttons **Child Lock 3 sec.**** for activating/deactivating the childproof lock → Page 46
- 5 **Basic Settings 3 sec.**** buttons for changing the appliance settings → Page 28
- 6 **Display panel**** for settings and information → Page 27

- 7 ►► button for:**
 - Starting a programme,
 - Interrupting a programme, e.g. to add items of laundry → Page 46,
 - Cancelling a programme → Page 46
- 8 Options ** → Page 27, → Page 39
- 9 **Buttons for changing the programme default settings:****
 - Temperature,
 - Spin speed (Spin),
 - Finish in

10 The **Remote Start**  button releases the appliance so that the programme can be started remotely via the Home Connect app. Remote start remains enabled for 24 hours after it has been activated. It is automatically deactivated if you do not start the programme via the Home Connect app during this time. If you carry out any operations on the appliance itself, such as opening the door or selecting a different programme, the remote start button is deactivated for safety reasons.

Notes

- Remote start can only be activated if the door is closed.
- Remote start cannot be activated if the childproof lock is on.

Press and hold the button for more than three seconds to access the Home Connect settings → *Page 48*.

Display panel

Main menu after selecting the programme

e.g. **Easy-Care**

The arrows on the display panel indicate in which direction the programme default settings can be changed using the buttons located above and below.



Others Programmes selected

and select, for example, the **Spin** programme:

Using the buttons below the arrows, you can select the required programme. The selection is acknowledged by a tick.

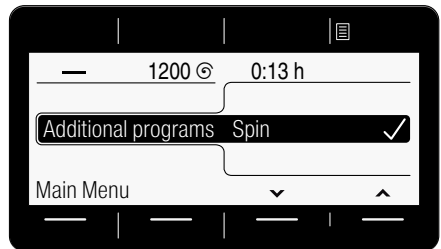

Wait or go back by pressing the **Main menu** button; the selected programme is displayed on the display panel.

en Getting to know the appliance

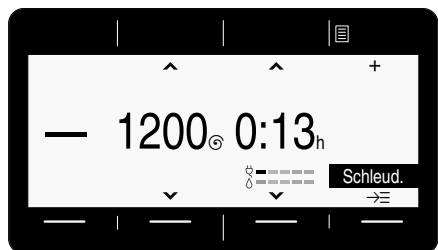

To change, select the button under the programme highlighted in black and change the programme.

Options button selected

and select, for example, the **Rinse Hold** () option:

Using the buttons under the two left-hand arrows, select the option. Using the two right-hand arrows, select the displayed value. The selected options are active immediately and are displayed on the display panel.

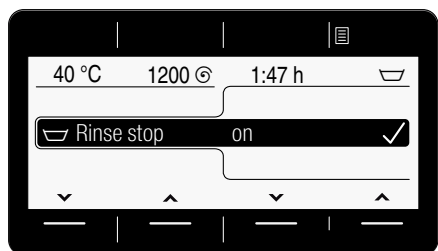



Wait or go back to the main menu by pressing the **Options**  button.

ASR Stain Automatic button selected

and select, for example, the **grass**  stain type:

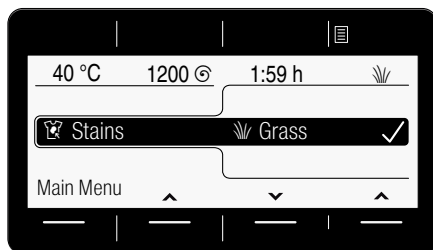
Using the two right-hand arrows, select the stain type. The selected stain type is active immediately and is displayed on the display panel.



Wait or go back to the main menu by pressing the **Main menu** or **ASR Stain Automatic**  button.

Basic Settings 3 sec. buttons selected

Change the appliance setting: e.g. volume of the **end signal** → *Page 54*

Using the buttons under the two left-hand arrows, select the setting. Using the two right-hand arrows, select the displayed value. The selection is acknowledged by a tick.

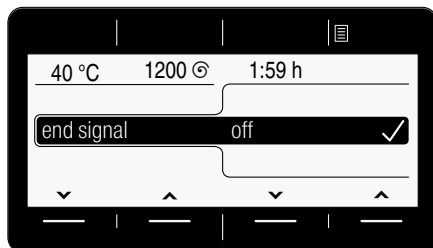

Wait or go back to the main menu by pressing the **Basic Settings 3 sec.** (press and hold again).



Laundry

Prepare the laundry

Caution!

Damage to the appliance/fabrics

Foreign objects (e.g. coins, paperclips, needles, nails) may damage the laundry or components in the washing machine.

You should therefore note the following tips when preparing your laundry:

- Empty any pockets.

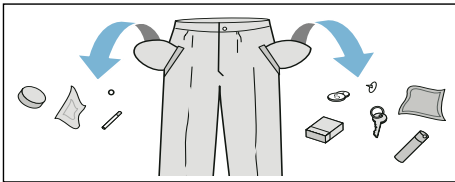

- Look out for metal items (paperclips, etc.) and remove them.
- Wash delicates in a laundry bag (tights, underwired bras, etc.).
- Close any zips; button up any cover buttons.
- Brush sand out of pockets and collars.
- Remove curtain fittings or place curtains in a laundry bag.

Sorting laundry

Sort your laundry according to the care instructions and manufacturer's information on the care labels, depending on:







- Type of fabric/fibre
- Colour
 - Note:** Laundry may discolour. Wash white and coloured items separately. Wash new coloured items separately the first time you wash them.
- Soiling
 - Wash laundry with the same level of soiling together.

Some examples of soiling levels can be found on → *Page 30*

- **Light:** Do not prewash, select the **speedPerfect**  setting if necessary
- **Normal**
- **Heavy:** Load less laundry, select a programme with prewash
- **Stains:** Remove/pretreat stains while they are fresh. Firstly, dab with soapy water; do not rub. Then wash the items of laundry with the appropriate programme. Stubborn or dried-in stains can sometimes only be removed by washing several times.

- Symbols on the care labels

Note: The numbers in the symbols indicate the maximum washing temperature that may be used.

-  Suitable for normal washing process; e.g. Cottons programme
-  A gentle washing process is required; e.g. Easy-Care programme
-  An especially gentle washing process is required; e.g. Delicate/Silk programme
-  Suitable for washing by hand; e.g.  Woollens programme
-  Do not machine wash.



Detergent

Correct selection of detergent

The care label is crucial for selecting the correct detergent, temperature and treatment of the laundry. → See also www.sartex.ch

If you visit www.cleanright.eu, you will find further information on detergents, care products and cleaning agents for domestic use.

- **Standard detergent with optical brighteners**
Suitable for boil-washable white laundry made from linen or cotton
Programme: Cottons/
cold - max. 90 °C
- **Detergent for colours without bleach or optical brighteners**
Suitable for coloured laundry made from linen or cotton
Programme: Cottons/
cold - max. 60 °C
- **Detergent for colours/delicates without optical brighteners**
Suitable for coloured laundry made from easy-care fibres, synthetic fibres
Programme: Easy-Care/
cold - max. 60 °C
- **Detergent for delicates**
Suitable for delicate, fine fabrics, silk or viscose
Programme: Delicate/Silk/
cold - max. 40 °C
- **Detergent for woollens**
Suitable for wool
Wool programme/
cold - max. 40 °C

Saving energy and detergent

For light and normal soiling, you can save energy (lower washing temperature) and detergent.

Saving	Soiling/note
<p>Reduced temperature and detergent quantity as per the recommended dosage</p>  <p>Temperature as per the care label and detergent quantity as per the recommended dosage for heavy soiling</p>	<p>Light No visible dirt or stains. Clothing has taken on some body odour, e.g.:</p> <ul style="list-style-type: none"> ■ Light summer/sports clothing (worn for a few hours) ■ T-shirts, shirts, blouses (worn for up to one day) ■ Guest bed linen and hand towels (used for one day) <p>Normal Visible dirt or a few light stains, e.g.:</p> <ul style="list-style-type: none"> ■ T-shirts, shirts, blouses (sweat soaked, worn a few times) ■ Towels, bedding (used for up to one week) <p>Heavy Dirt and/or stains clearly visible, e.g. tea towels, baby items, work clothing</p>

Note: When measuring the amount of all detergents/additives/care products and cleaning agents, please always check the manufacturer's instructions and information. → Page 44

Overview of programmes





Programmes on the programme selector

Programme/type of laundry/instructions	Settings
Name of the programme Brief explanation of the programme and the fabrics for which it is suitable.	Max. load Temperature that can be selected; (☹️* = cold) Spin speed that can be selected; 0 = no spin cycle, draining only Additional programme settings that can be selected*
Cotton Hard-wearing fabrics, heat-resistant fabrics made of cotton or linen Note: . The speedPerfect ⚡️🕒 setting is suitable as a short programme for lightly soiled laundry.	Max. 9 kg/5*** kg ☹️*90 °C 0-1600** rpm 🕒, ⚡️🕒, 🧺, ⬇️, 🧺, ⬆️, 🧺, 🧺, 🧺, 🧺, 🧺, 🧺
Cotton Eco ◀️ Hard-wearing fabrics, heat-resistant fabrics made of cotton or linen; Energy-optimised washing by reducing the temperature while achieving a comparable washing result for the Cotton programme. Note: . The actual washing temperature may differ from the stated programme temperature for energy-saving reasons; the washing performance corresponds to the selected temperature.	Max. 9 kg ☹️*90 °C 0-1600** rpm 🧺, ⬇️, 🧺, ⬆️, 🧺, 🧺, 🧺, 🧺, 🧺
Easy-Care Textiles made of synthetic materials or blended fabrics	Max. 4 kg ☹️* - 60 °C 0-1200** rpm 🕒, ⚡️🕒, 🧺, ⬇️, 🧺, ⬆️, 🧺, 🧺, 🧺, 🧺, 🧺
* The programmes and additional programme settings are model-dependent. The programmes/settings that are available can either be selected directly in the control panel or under Others Programmes or Options 📖.	
** Max. The maximum spin speed depends on the model and programme	
*** Reduced load for the speedPerfect ⚡️🕒 setting	

Programme/type of laundry/instructions	Settings
<p>Mixed Fabrics</p> <p>Mixed load of cottons and synthetic fabrics</p>	<p>Max. 4 kg</p> <p> 40 °C</p> <p>0-1600** rpm</p> <p> , , , , , , , , , </p>
<p>Delicates / Silk</p> <p>Delicate, washable fabrics, e.g. made of silk, satin, synthetic fibres or blends (e.g. silk blouses, silk scarves)</p> <p>Note: . Use a detergent suitable for machine washing delicate fabrics or silk.</p>	<p>Max. 2 kg</p> <p> 40 °C</p> <p>0-800** rpm</p> <p> , , , , , , , </p>
<p> Wool</p> <p>Hand- or machine-washable fabrics that are made of wool or contain wool;</p> <p>particularly gentle wash programme to prevent laundry from shrinking, with longer pauses in the programme (during which the items rest in the water)</p> <p>Notes</p> <ul style="list-style-type: none"> ■ Wool is of animal origin, e.g. angora, alpaca, llama, sheep. ■ Use a detergent that is suitable for machine-washing wool. 	<p>Max. 2 kg</p> <p> 40 °C</p> <p>0-800** rpm</p> <p> , </p>
<p>Hygiene</p> <p>Hard-wearing fabrics made of cotton or linen</p> <p>Note: . Particularly suitable for strict hygiene requirements or particularly sensitive skin thanks to the extended wash cycle at a defined temperature, higher water level and extended rinse cycle.</p>	<p>Max. 6,5kg</p> <p> 60 °C</p> <p>0-1600** rpm</p> <p> , , , , , , , , </p>
<p>Rapid 15'/30' *</p> <p>Extra-short programme of approx. 15 / 30 minutes, suitable for small items of lightly soiled laundry</p> <p>Note: . The Rapid 15' programme is run for the speedPerfect setting.</p>	<p>Max. 2 / 3,5 kg</p> <p> 40 °C</p> <p>0-1200** rpm</p> <p> , , </p>
<p>Rapid 15' *</p> <p>Extra-short programme of approx. 15 minutes, suitable for small items of lightly soiled laundry</p>	<p>Max. 2 kg</p> <p> 40 °C</p> <p>0-1200** rpm</p> <p> , </p>
<p>* The programmes and additional programme settings are model-dependent. The programmes/settings that are available can either be selected directly in the control panel or under Others Programmes or Options .</p> <p>** Max. The maximum spin speed depends on the model and programme</p> <p>*** Reduced load for the speedPerfect setting</p>	

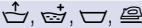
Programme/type of laundry/instructions	Settings
<p>Rapid 60 *</p> <p>Extra-short programme of approx. 60 minutes, suitable for small items of lightly soiled laundry</p>	<p>Max. 5 kg</p> <p> - 60 °C</p> <p>0-1600** rpm</p> <p> , , , , , , , </p>
<p>Dark wash / Jeans</p> <p>Dark-coloured cottons and dark-coloured easy-care fabrics; Turn items inside-out before washing.</p>	<p>Max. 3.5 kg</p> <p> - 40 °C</p> <p>0-1200** rpm</p> <p> , , , , , , , , </p>
<p>Outdoor *</p> <p>Membrane-coated weatherproof or outdoor clothing and water-resistant fabrics</p> <p>Notes</p> <ul style="list-style-type: none"> ■ Use special detergent suitable for machine washing; add the correct dosage to compartment II in accordance with the manufacturer's instructions. ■ Laundry must not be treated with fabric softener. ■ Before washing, clean the detergent drawer thoroughly (all compartments) to remove fabric-softener residue. 	<p>Max. 2 kg</p> <p> -40 °C</p> <p>0-800** rpm</p> <p> , , , , , , </p>
<p>Nightwash *</p> <p>Especially quiet programme for washing during the night; suitable for cotton, linen, synthetic and blended fabrics</p> <p>Notes</p> <ul style="list-style-type: none"> ■ End signal deactivated, ■ reduced final spin speed set by default and shorter washing time 	<p>Max. 4 kg</p> <p> -40 °C</p> <p>0-1200** rpm</p> <p> , , , , , , , </p>
<p>Duvet *</p> <p>Machine-washable items stuffed with synthetic fibres, such as pillows, quilts and bedspreads; also suitable for items stuffed with down</p> <p>Note: . Wash large items separately. Use a detergent designed for delicates and follow the instructions on the item's care label. Use detergent sparingly.</p>	<p>Max. 2.5 kg (down: Max. 2 kg)</p> <p> - 60 °C</p> <p>0-1200** rpm</p> <p> , , , , </p>
<p>* The programmes and additional programme settings are model-dependent. The programmes/settings that are available can either be selected directly in the control panel or under Others Programmes or Options .</p> <p>** Max. The maximum spin speed depends on the model and programme</p> <p>*** Reduced load for the speedPerfect setting</p>	

Programme/type of laundry/instructions	Settings
<p>Shirt s/ Blouses</p> <p>Non-iron shirts or blouses made of cotton, linen, synthetic fibres or blended fabrics</p> <p>Notes</p> <ul style="list-style-type: none"> Shirts/blouses are only given a short spin on the Less Ironing (👕) setting. Hang them up to dry while still dripping wet. -> Self-smoothing effect Use the Delicates / Silk programme to wash shirts/blouses made of silk or delicate fabrics. 	<p>Max. 2 kg</p> <p>👕* - 60 °C</p> <p>0-800** rpm</p> <p>🕒, ⏸️, 🧺, ⏴, 🧺, 🧺, 🧺, 🧺, 🧺, 🧺</p>
<p>Down Wear *</p> <p>Machine-washable fabrics stuffed with down, such as pillows and duvets; also suitable for items stuffed with synthetic fibres</p> <p>Note: . Wash large items separately. Use a detergent designed for delicates and follow the instructions on the item's care label. Use detergent sparingly.</p>	<p>Max. 2 kg</p> <p>👕* - 60 °C</p> <p>0-1200** rpm</p> <p>🕒, ⏸️, 🧺, 🧺, 🧺</p>
<p>Lingerie *</p> <p>For delicate, washable underwear, e.g. made of velvet, lace, Lycra, silk or satin</p>	<p>Max. 1 kg</p> <p>👕* - 40 °C</p> <p>0-600** rpm</p> <p>🕒, ⏸️, 🧺, 🧺, 🧺, 🧺, 🧺, 🧺, 🧺, 🧺</p>
<p>Curtains *</p> <p>3.5 kg heavy curtains or 25-30 m² lightweight drapes</p> <p>Notes</p> <ul style="list-style-type: none"> Shorter rinse and final spin cycles. Use a detergent that is suitable for machine-washing curtains. The Prewash (⏴) button is preset by default. If you do not require a pre-wash cycle, press the button to deactivate the function. 	<p>Max. 3.5 kg</p> <p>👕* - 40 °C</p> <p>0-800** rpm</p> <p>🕒, ⏸️, 🧺, ⏴, 🧺, 🧺, 🧺, 🧺, 🧺, 🧺</p>
<p>* The programmes and additional programme settings are model-dependent. The programmes/settings that are available can either be selected directly in the control panel or under Others Programmes or Options 📄.</p> <p>** Max. The maximum spin speed depends on the model and programme</p> <p>*** Reduced load for the speedPerfect ⏸️ setting</p>	

Programme/type of laundry/instructions	Settings
<p>Drum Clean</p> <p>Programme for cleaning and caring for the drum and the outer tub, e.g. before running the first wash cycle, if washing frequently at a low temperature (40 °C or lower) or if an odour has developed after a prolonged period of non-use. The Drum Clean indicator lamp flashes when you have not used a programme of 60 °C or higher for a long time.</p> <p>Notes</p> <ul style="list-style-type: none"> ■ Run the drum-care programme without any laundry. ■ Use washing powder or a detergent that contains bleach. To prevent foaming, only use half the amount of detergent recommended by the detergent manufacturer. Do not use detergents that are intended for woollens or delicates. 	<p>0 kg</p> <p>80, 90 °C</p> <p>1200 rpm</p> <p></p>
<p>Rinse</p> <p>Rinse Plus with spin</p>	<p>-</p> <p>-</p> <p>0-1600** rpm</p> <p></p>
<p>Spin</p> <p>Extra spin with selectable speed</p>	<p>-</p> <p>-</p> <p>0-1600** rpm</p> <p></p>
<p>Drain</p> <p>For the rinsing water, e.g. after the  setting (Rinse Hold = no final spin cycle)</p>	<p>-</p> <p>-</p> <p>-</p> <p>-</p>
<p>* The programmes and additional programme settings are model-dependent. The programmes/settings that are available can either be selected directly in the control panel or under Others Programmes or Options .</p> <p>** Max. The maximum spin speed depends on the model and programme</p> <p>*** Reduced load for the speedPerfect  setting</p>	

Programme/type of laundry/instructions	Settings
<p>Textile Guard *</p> <p>Wash cycle followed by waterproofing of membrane-coated weatherproof and outdoor clothing or water-resistant items</p> <ol style="list-style-type: none"> 1. Select a programme. 2. Add special detergent for outdoor clothing to compartment II. 3. Add a waterproofing agent (max. 170 ml) to compartment ☼. 4. Press the ► button. After-treat the laundry in accordance with the manufacturer's instructions. <p>Notes</p> <ul style="list-style-type: none"> ■ Use a special detergent suitable for machine washing and add the correct dosage in accordance with the manufacturer's instructions: ■ Laundry must not be treated with fabric softener. ■ Before washing, clean the detergent drawer thoroughly (all compartments) to remove fabric-softener residue. 	<p>Max. 1 kg</p> <p> 40 °C</p> <p>0-800** rpm</p> <p> , , , , , , , </p>
<p>Sportswear *</p> <p>Sportswear and leisurewear made from microfibre fabrics</p> <p>Notes</p> <ul style="list-style-type: none"> ■ Laundry must not be treated with fabric softener. ■ Before washing, clean the detergent drawer thoroughly (all compartments) to remove fabric-softener residue. 	<p>Max. 2 kg</p> <p> 40 °C</p> <p>0-800** rpm</p> <p> , , , , , , , </p>
<p>Auto *</p> <p>Hard-wearing fabrics;</p> <p>The degree of soiling and the type of fabric are automatically detected and the washing sequence and intelligent dosing are adjusted accordingly.</p>	<p>Max. 6 kg</p> <p>40 °C</p> <p>1400** rpm</p> <p> , , </p>
<p>Auto Soft *</p> <p>Gentler treatment of the laundry;</p> <p>The degree of soiling and the type of fabric are automatically detected and the washing sequence and intelligent dosing are adjusted accordingly.</p>	<p>Max. 3.5 kg</p> <p>30 °C</p> <p>1000** rpm</p> <p> , , </p>
<p>Memory *</p> <p>For saving regularly used individual programme settings → Page 37</p>	<p>Settings as for the selected programme</p>
<p>* The programmes and additional programme settings are model-dependent. The programmes/settings that are available can either be selected directly in the control panel or under Others Programmes or Options .</p> <p>** Max. The maximum spin speed depends on the model and programme</p> <p>*** Reduced load for the speedPerfect setting</p>	

Starching

Note: Laundry should not be treated with fabric softener.

Liquid starch can be used to stiffen fabrics particularly in the Rinse and Cottons programmes. Measure starch into compartment  in accordance with the manufacturer's instructions (clean first if necessary).

Dyeing/bleaching

Dye should only be used in normal household quantities. Salt may damage stainless steel. Always follow the dye manufacturer's instructions.

Do **not** use the washing machine to bleach clothes.

Memory (depending on the model)

The programme and all settings are permanently stored under Memory.

To store:

1. Select the **Memory** programme.
2. If a programme has not yet been selected for the Memory programme, select a programme according to the instructions on the display panel. The selection of the programme is automatically acknowledged by a tick.
3. In the main menu, change the temperature, spin speed and "ready in" time and/or select additional programme settings if required.

The programme is automatically saved and displayed in the main menu.

Note: The saved programme can be changed by pressing the button under the programme. → *"Display panel"* on page 27

P+ Programme default settings

The programme default settings are displayed in the main menu after selecting the programme.

Display panel → *Page 27*

You can change the default settings as long as the arrow is displayed in the main menu.

An overview of all programme settings, which can be selected depending on the programme, can be found from → *Page 31*.

Temperature

Depending on what stage the programme is in, you can change the set temperature before and during the programme.

The maximum temperature that can be set depends on the programme that has been selected.

Spin speed

(Spin)

Depending on what stage the programme is in, you can change the spin speed (in rpm; revolutions per minute) before and during the programme.

The maximum speed that can be set depends on the model and programme that has been selected.

Setting 0: No spin cycles, the water is only drained. The laundry stays wet inside the drum, e.g. for items that should not be spun.

Finish in

The programme duration is shown after selecting the programme.

Before starting the programme, you can preselect the programme end in hourly increments (h = hour) up to a maximum of 24 hours.

After starting the programme, the selected number of hours **e.g. 8 h** is shown on the display panel and counts down until the wash programme starts. The duration of the programme is then displayed.

Note: The programme duration is automatically adjusted when the programme is running. Changes to the programme default settings or programme settings, options, foam detection function, unbalanced load detection, the load or soiling may also change the programme duration.

After starting the programme, you can change the preselected number of hours as follows:

1. Press the ►|| button.
2. Use the **Finish in** button to change the number of hours.
3. Press the ►|| button.

After starting the programme, while the programme is running, you can add or remove laundry if necessary.
→ *Page 46*

P⁺ Additional programme settings/options (* depending on the model)

The settings/options that are available depend on the model.

Depending on the programme selected, you can select different settings/options in order to better adapt the washing process to your items of laundry.

The settings can be selected:

- via the corresponding button on the control panel or
- via the Options  button.
→ Page 26

An overview of all additional settings, which can be selected depending on the programme, can be found from
→ Page 31.

speedPerfect

Washing in a shorter time while achieving a washing result that is consistent with, but uses more energy than, the selected programme, without the speedPerfect  setting.

Note: Do not exceed the maximum load.

Overview of programmes → Page 31

ecoPerfect

Energy-optimised washing by reducing the temperature while achieving a washing result that is consistent with the selected programme, without the ecoPerfect  setting.

Prewash *

()

Settings that can be selected:
on – off



For heavily soiled laundry.

Note: Pour detergent into compartments **I** and **II**.

Extra Rinse *

()

Settings that can be selected:

 **+ 1 Rinse**
 **+ 2 Rinse**
 **+ 3 Rinse**
off

Additional rinse cycles depending on the programme; longer programme duration for particularly sensitive skin and/or for areas with very soft water.

Water Plus *

()

Settings that can be selected:
on – off

Increased water level, gentler treatment of the laundry.

Less Ironing *

()

Settings that can be selected:
on – off

Reduces creasing thanks to a special spin sequence followed by fluffing and reduced spin speed.

Note: The washing's residual moisture is increased.

Soak *



Settings that can be selected:

on – off

Before the main wash cycle starts, the washing remains for longer in the water to partially dissolve intensive soiling.

To be used for particularly stubborn soiling; put detergent in dispenser **I** before starting the appliance.

Notes

- Load laundry of the same colour.
- If your machine does not have this option, you can soak as follows:
 1. Select the **Cotton 30 °C** programme and the ►|| button.
 2. Press the ►|| button after approx. 10 minutes. The laundry remains in the soaking solution.
 3. Leave the laundry to soak for as long as required, then either press the ►|| button again to continue the programme or change the programme.

Note: No additional detergent is required; the soaking solution is used for washing.

Rinse Hold *



Settings that can be selected:

on – off

The washing remains in the water after the last rinse cycle. End the programme
→ Page 47

Silent Wash *



Settings that can be selected:

on – off

















Reduced noise values thanks to special wash and spin cycle and deactivated end signal. Especially suitable for washing at night.

Note: Residual moisture of the washing is slightly increased.

ASR Stain Automatic

In total, there are 16 different types of stain to choose from.

Types of stain that can be selected:

	Baby food
	Blood
	Egg
	Strawberry
	Soil + sand
	Grass
	Coffee
	Cosmetics
	Orange
	Red wine
	Chocolate
	Sweat
	Dirty socks
	Grease + oil
	Tea
	Tomatoes

off

Do not let stains dry. Remove solid substances beforehand.

Select a programme with a stain type:

1. Arrange items of washing as usual.
2. Select a programme.
3. Load the washing machine
4. Select a stain type (depending on the selected programme).
→ Page 28
5. Start the programme.

The washing machine adjusts the average washing temperature, drum movement and soaking time to the specific type of stain. Hot or cold water, gentle or intensive washing and long or short soaking ensure that the wash-programme sequence is specially adapted to each type of stain. This makes sure that stains are treated in the best possible way.

The treatment of two stains explained in the following example:

Blood

Blood is first “dissolved” in cold water, then the selected wash programme starts.

Egg

Egg particles are removed by soaking in the lukewarm water bath, selecting a wash cycle with a high water level and running additional rinse cycles.

Following intensive research, we have developed comparable solutions for other stains.



Operating the appliance

Preparing the washing machine

Note: The washing machine **must be correctly installed** and **connected**.

From → *Page 14*

1. Plug into the mains.
2. Turn on the tap.
3. Open the washing machine door.
4. Check that the drum is completely drained. Drain if necessary. Otherwise, the load display may malfunction. → *Page 55*

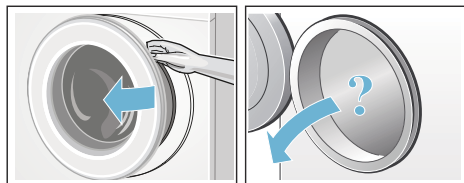

Switching on the appliance/ selecting a programme

Press the ① button. The appliance is switched on.

The Siemens logo appears on the display and all indicator lamps light up.

The **Cotton** programme set at the factory is then always displayed.

You can:

- use this programme **or**
- select another programme on the control panel **or**
- select a programme under **Others**. → *Page 27*

Note: If you have activated the childproof lock, you must deactivate it before you can set a programme. → *Page 46*

The indicator lamp on the programme selector lights up and the main menu with the **programme default settings** for the selected programme appear on the display panel: → *Page 27*

- Temperature,
- Spin speed,
- Programme duration,
- Any additional settings and
- Information on water and energy consumption. → *Page 13*

In appliances with a **drum light**:

The drum is lit after switching on the appliance, after opening and closing the door and after starting the programme. The light switches off automatically.

You can:

- use the programme default settings and load laundry → *Page 43*,
- or change the programme default settings and/or select additional settings.

Change the programme default settings

You can use or change the default settings for each washing cycle.

To do this, repeatedly press the corresponding button until the required setting is displayed. → *Page 27*

Note: Pressing and holding the buttons automatically runs through the set values.

The settings are activated without needing to be confirmed.



The settings are not saved after the washing machine is switched off.

Programme default settings
→ *Page 38*

Select additional programme settings

By selecting additional settings/options, you can better adapt the washing process to your items of laundry.

The settings can be selected or deselected depending on the progress of the programme. → *Page 27*

The ecoPerfect  and speedPerfect  button indicator lamps light up if a setting is activated.

The other settings are indicated by a symbol on the display panel if the setting is activated.

For multi-level settings, press and hold the buttons to run through the settings automatically.

The settings are not saved after the washing machine is switched off.

Additional programme settings/options → *Page 39*

Placing laundry into the drum

Warning **Risk of death!**

Items of laundry pretreated with cleaning agents that contain solvents, e.g. stain remover/cleaning solvent, may cause an explosion after being loaded into the washing machine. Hand-rinse these items of laundry thoroughly beforehand.

Load the pre-sorted, unfolded laundry into the drum. The load screen for the selected programme (e.g. for **Easy-Care**) is indicated on the display panel.

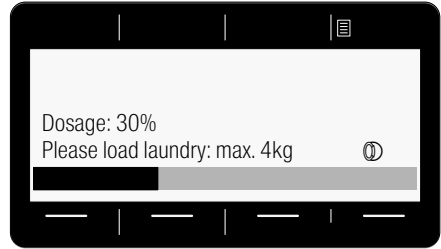

The load bar fills as the laundry is loaded. If the maximum load is exceeded, the bar flashes. Observe the maximum indicated load. Overfilling adversely affects the washing result and encourages creasing.

Notes

- Mix items of laundry of varying sizes. Laundry items of different sizes distribute themselves better during the spin cycle. Individual laundry items may cause an unbalanced load. → *Page 55*
- Wait until the Siemens logo no longer appears before adding laundry.
- The load screen appears when the door is opened or when the amount of laundry is changed.

Measure and add detergent and care products

Caution!

Damage to the appliance

Cleaning agents and agents for pre-treating laundry (e.g. stain removers, prewash sprays, etc.) may cause damage if they come into contact with the surfaces of the washing machine. Do not allow these agents to come into contact with the surfaces of the washing machine. If necessary, immediately wipe away spray residue and other residues/droplets with a damp cloth.

Dosing

Dose detergents and care products according to:

- the dosing recommendation on the display panel, e.g. for **Easy-Care**. Depending on the amount of washing in the washing machine, a dosing recommendation is indicated on the display panel.

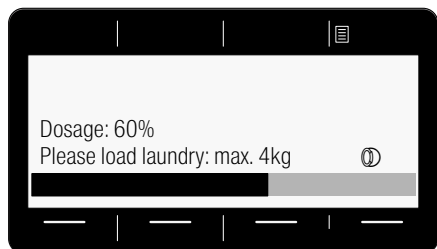

- soiling,
- water hardness; (ask your water supply company),
- the manufacturer's specifications on the packaging.

Filling



Warning Eye/skin irritation!

Detergents and care products may spray out if the detergent drawer is opened while the machine is in operation.

Open the drawer carefully. Rinse eyes/skin thoroughly if they come into contact with detergents or care products.

If accidentally swallowed, seek medical advice.

Note: Dilute viscous fabric softener and fabric conditioner with a little water. This prevents blockages in the washing machine's piping.

Pour the detergent and care products into the appropriate compartments:

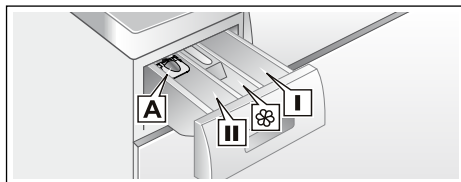

- Measuring aid **A** For liquid detergent
Compartment **II** Detergent for the main wash, water softener, bleach, stain remover
Compartment **⊗** Fabric softener, liquid starch;
do not exceed **max.**
Compartment **I** Detergent for prewash

1. Pull out the detergent drawer as far as possible.
2. Add detergent and/or care products.
3. Close the detergent drawer.

Measuring aid* for liquid detergent

*depending on the model

Position the measuring aid for dosing the correct amount of liquid detergent:

1. Pull out the detergent drawer. Press down the insert and fully remove the drawer.
2. Slide the measuring aid forwards, fold it down and click it into place.
3. Reinsert the drawer.

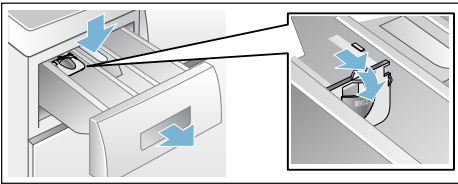

Note: Do not use the measuring aid for gel detergents and washing powder, or for programmes with prewash or when the “Ready in” time is selected.

For models without a measuring aid, pour the liquid detergent into the appropriate dispenser and place it in the drum.

Start the programme

Make sure that no items of laundry are trapped between the door and the rubber seal, and close the door.

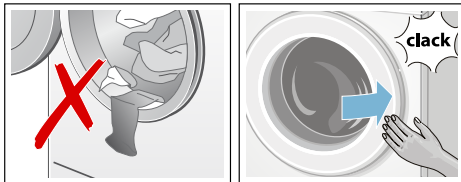

The main menu for the selected programme is indicated again on the display panel.

Press the ►|| button to start the programme.

During washing, the progress of the programme is displayed in a bar on the

display panel. The bar fills in during the washing cycle and provides information about the current progress of the programme.

The arrows fade in and out according to the progress of the programme. They indicate the programme settings/ options which can be changed/added as the programme progresses.

Some programme sequence steps explained:

- **Load adjust active** → Page 55

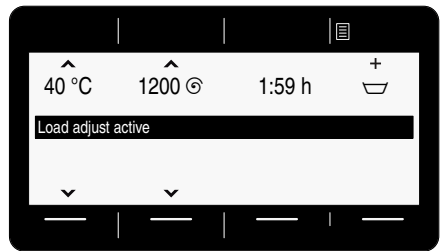

- **Pre-washing, Washing, Rinsing, Spin, Drain ...** are displayed during the wash cycle.

- **Extra rinse: foam**

Note: Foam detection

If **Foam has been detected** also appears on the display panel, the washing machine has detected too much foam during the wash programme and has automatically switched on one or more rinse cycles in order to remove the foam. Add less detergent to the next washing cycle with the same load.

- Other displays → Page 60

If you want to lock the programme to prevent it from being inadvertently adjusted, you can select the childproof lock as follows.

Child Lock 3 sec.

You can lock the washing machine to prevent the functions you have set from being changed inadvertently.

To **activate**/deactivate, press and hold both buttons **Child Lock 3 sec.** for approx. three seconds. → *Page 26*
☞ **Childproof lock activated** appears in the display panel.

After approx. three seconds, the display reverts back to the main menu.

If you adjust the programme selector or select a button when the childproof lock is activated, ☞ **Childproof lock activated** appears in the display panel.

Notes

- The childproof lock can be activated regardless of the appliance's status.
- The childproof lock remains active, even once the washing machine has been switched off. Before selecting the next programme, deactivate the childproof lock.
- If the appliance is switched off while the programme is running and childproof lock is activated, the programme continues when the appliance is switched back on.

Adding laundry

After starting the programme, you can add or remove laundry if necessary.

Press the ►|| button to do this.

The ►|| button indicator lamp flashes and the machine checks whether it is possible to add laundry.

It is possible to add laundry when **Pause: Reload is possible** appears on the display.

To continue the programme, press the ►|| button. The programme continues automatically.

Notes

- Do not leave the door open for too long when adding laundry as water from the laundry may leak out.
- For safety reasons, the door remains locked when the water level or temperature is high, or while the drum is turning, and it is not possible to add laundry during this time. Follow the information on the display panel.
- The load display is not active during reloading.

Changing the programme

If you have started the wrong programme by mistake, you can change the programme as follows:

1. Press the ►|| button.
2. Select another programme.
3. Press the ►|| button. The new programme starts from the beginning.

Cancel the programme

For programmes at high temperatures:

1. Press the ►|| button.
2. To cool down laundry: Select **Rinse**.
3. Press the ►|| button.

For programmes at low temperatures:

1. Press the ►|| button.
2. Select **Spin** or **Drain**.
3. Press the ►|| button.

Programme end during rinse hold

The following appears on the display panel:

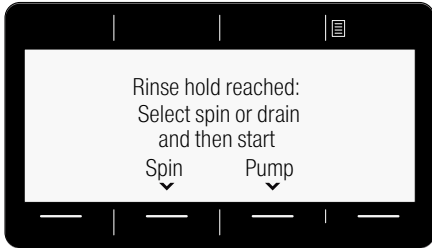

Continue the programme by:

- Select the **Spin** (change the spin speed if necessary) or the **Drain** programme.
- Press the ►|| button.

Programme end

©**Finished, remove washing** appears on the display panel. The ►|| button indicator lamp is off.

Removing laundry/switching off the appliance

1. Open the loading door and remove the laundry. Follow the information on the display panel.
2. Press the ① button. The appliance is switched off.
3. Turn off the tap.

Note: Not required for AquaStop models.

Notes

- Do not leave any items of laundry in the drum. They may shrink in the next wash or discolour another item.
- Remove any foreign objects from the drum and the rubber gasket – risk of rusting.
- Wipe the rubber gasket dry.

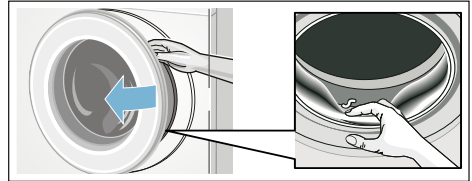

Notes

- Leave the loading door and detergent drawer open so that any residual water can evaporate.
- Always wait until the programme ends, as the appliance could still be locked. Then switch the appliance on and wait for it to unlock.
- If the display panel goes off at the end of a programme, the energy-saving mode is active. Press any button to activate the panel.

Home Connect

This appliance is Wi-Fi enabled and can be controlled remotely via a smartphone or tablet PC.

With the Home Connect app, you can use your smartphone or tablet PC to do the following on this appliance:

- Select and start programmes.
- Change programme settings.
- Query the status of programmes.
- Change appliance settings.
- Switch off the appliance.

Before you can use the Home Connect functions, you will need to install the Home Connect app on your smartphone or tablet PC, register, connect your appliance automatically **or** manually to your home Wi-Fi network (you only need to do this the first time) and then connect your mobile device to your appliance via the Home Connect app.

You can find information about the app on our Home Connect website www.home-connect.com.

Notes

- Please observe the safety precautions in this instruction manual and make sure that these are complied with even when operating the appliance via the Home Connect app while you are away from home. You must also follow the instructions in the Home Connect app.
- You cannot use the Home Connect app to make changes while the appliance is in operation. You will be able to use the Home Connect app to see any adjustments made directly on the appliance itself, however.

Connecting to your home network automatically

If your router has a WPS function, you can connect the appliance to your home network automatically.

If your router does not have a WPS function, you will need to connect the appliance to your home network manually → *Page 49*.

Wi-Fi must be switched on at the appliance.

1. Switch the appliance on.
2. Press and hold the **Remote Start**  button for more than three seconds. **Aut. network log-in** appears in the display panel.
3. Use either of the right-hand arrow buttons to select **Connect**.

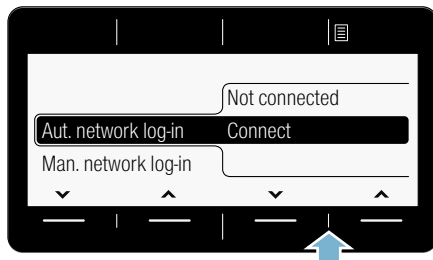

The appliance will now try to connect to your home network.

4. Activate the WPS function on your home network router within the next two minutes.

If the appliance has successfully connected to the home network, **Connected** ✓ appears in the display panel.

5. You can exit the Home Connect settings by selecting the **Remote Start**  button.

Note: If you were not able to establish a connection, check whether your appliance is within range of the home network and repeat the manual connection. Try connecting automatically again or connect your appliance manually → *Page 49*.

Connecting to your home network manually

If you have already automatically connected your appliance to your home network, you can skip the manual connection step and connect it to the Home Connect app → *Page 50*.

If your router does not have a WPS function, you will need to connect the appliance to your home network manually.

Wi-Fi must be switched on at the appliance.

1. Switch the appliance on.
2. Press and hold the **Remote Start**  button for more than three seconds. **Aut. network log-in** appears in the display panel.
3. Use either of the left-hand arrow buttons to select **Man. network log-in**.

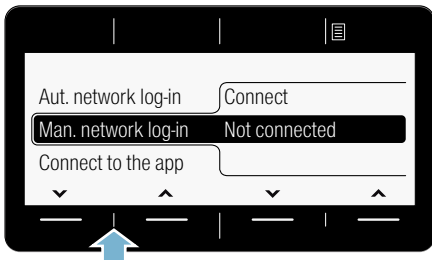

4. Use either of the right-hand arrow buttons to select **Connect**.

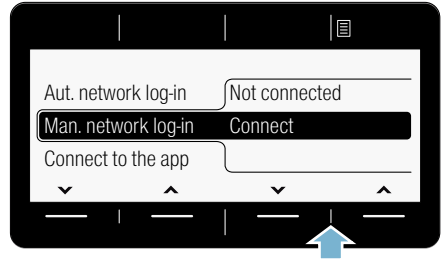

The appliance will now set up its own Wi-Fi network with the name (SSID) **HomeConnect**, which you can access from your smartphone or tablet PC.

5. Call up the Wi-Fi settings on your smartphone or tablet PC.
6. Connect your smartphone or tablet PC to the **HomeConnect** Wi-Fi network and enter the Wi-Fi password (key) "**HomeConnect**".
Note: The connection process may take up to 60 seconds.
7. Once you have connected successfully, open the Home Connect app on your smartphone or tablet PC.
8. In the Home Connect app, enter the name (SSID) and password (key) for **your home network** and then select **Transfer to appliance**.

If the appliance has successfully connected to the home network, **Connected** ✓ appears in the display panel.



9. You can exit the Home Connect settings by selecting the **Remote Start**  button.

Notes

- If you were not able to establish a connection, check whether your appliance is within range of the home network and repeat the manual connection.
- If your smartphone or tablet PC is still connected to the **HomeConnect** network, you will need to connect it to your home network first.

Connecting to the Home Connect app

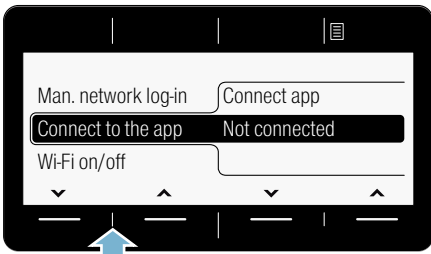

If your appliance is connected to your home network, you can connect it to the Home Connect app.

1. Switch the appliance on.
2. Wait until the  symbol appears in the display panel.
3. Press and hold the **Remote Start**  button for more than three seconds. **Aut. network log-in** appears in the display panel.
4. Use either of the left-hand arrow buttons to select **Connect to the app**.

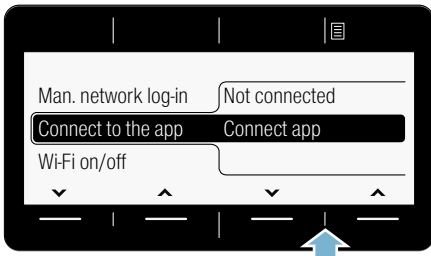

5. Use either of the right-hand arrow buttons to select **Connect app**. The appliance will now connect to your Home Connect app.



6. Open the Home Connect  app on your smartphone or tablet PC and select **Connect** to add your new appliance.
Note: If your smartphone or tablet PC is still connected to the **HomeConnect** network, you will need to connect it to your home network first.
7. If your appliance is not shown automatically, select **Appliance search** and then **Connect an appliance** in the Home Connect app.
8. Carry out the last steps in the Home Connect app to connect your appliance.
9. Use the right-hand arrow button to select **Continue** on the appliance.
If the appliance has connected successfully, **App(s) connect.** will appear in the display panel.
10. You can exit the Home Connect settings by selecting the **Remote Start**  button.

Note: If you were not able to establish a connection, check whether your smartphone or tablet PC is within range of your home network or is connected to this. Try connecting to the Home Connect app again.

Switching Wi-Fi on and off

You can switch the Home Connect function on your appliance on or off permanently at any time.

1. Switch the appliance on.
2. Press and hold the **Remote Start**  button for more than three seconds. **Aut. network log-in** appears in the display panel.
3. Use either of the left-hand arrow buttons to select **Wi-Fi on/off**.

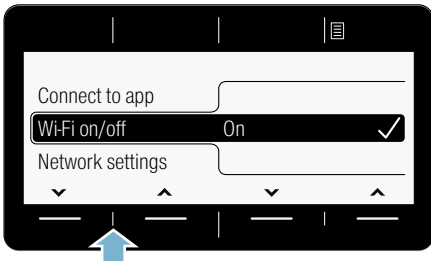

4. Use either of the right-hand arrow buttons **on** or **off** to switch Wi-Fi on or off.

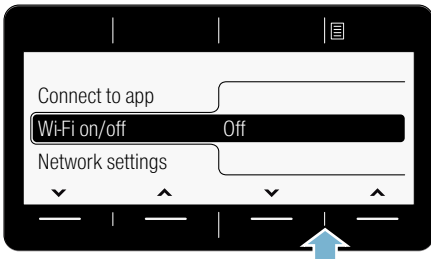

5. You can exit the Home Connect settings by selecting the **Remote Start**  button.

Notes

- If Wi-Fi is switched off on your appliance, you will no longer be able to connect it to your home network or to the app.
- If you have switched Wi-Fi on, the automatic switch-off is set to **Never**.

Resetting your network settings

You can clear the network settings and break the connection to your smartphone or tablet PC by resetting the network settings.

1. Switch the appliance on.
2. Press and hold the **Remote Start**  button for more than three seconds. **Aut. network log-in** appears in the display panel.
3. Use either of the left-hand arrow buttons to select **Network settings**.

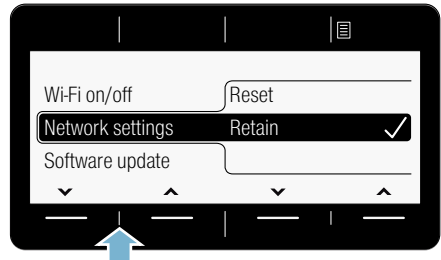

4. Use either of the right-hand arrow buttons to select **Reset**.

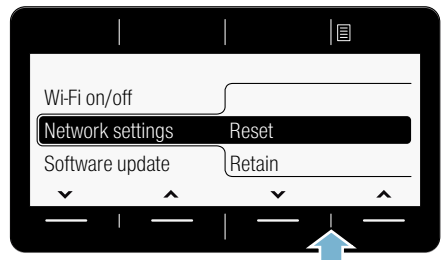

5. Use either of the right-hand arrow buttons to select **Continue**. The network settings are now reset. Your appliance is no longer connected to your home network or the Home Connect app.
6. You can exit the Home Connect settings by selecting the **Remote Start**  button.

Note: If you want to operate the appliance via the Home Connect app again, you must reconnect it to your home network and to the Home Connect app either automatically or manually.

Updating the software

You can update the Home Connect software on your appliance. As soon as a new update is available, a note appears in the display panel for your appliance.

You can install the update directly via the message on the display panel or via the appliance settings.

1. Switch the appliance on.
2. Press and hold the **Remote Start**  button for more than three seconds. Aut. network log-in appears in the display panel.
3. Use either of the left-hand arrow buttons to select **Software update**.

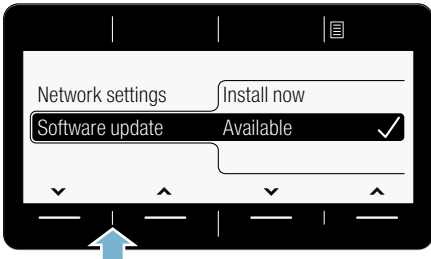

4. Use either of the right-hand arrow buttons to select **Install now**.

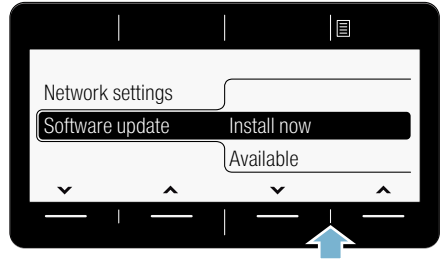

Update installation will now start. This process may take several minutes. **Do not switch the appliance off while updates are being installed.**

5. You can exit the Home Connect settings by selecting the **Remote Start**  button.

Note: If no software update is available, **Not available** appears in the display panel. The Home Connect software is completely up-to-date.

About data protection

When your appliance is connected for the first time to a WLAN network, which is connected to the Internet, your appliance transmits the following categories of data to the Home Connect server (initial registration):

- Unique appliance identification (consisting of appliance codes as well as the MAC address of the installed WiFi communication module).
- Security certificate of the WiFi communication module (to ensure a secure IT connection).
- The current software and hardware version of your domestic appliance.
- Status of any previous resetting to factory settings.

This initial registration prepares the Home Connect functions for use and is only required when you want to use these Home Connect functions for the first time.

Note: Ensure that the Home Connect functions can be used only in conjunction with the Home Connect app. Information on data protection can be accessed in the Home Connect app.

Declaration of Conformity

BSH Hausgeräte GmbH hereby declares that the appliance with Home Connect functionality meets the basic requirements and other relevant provisions of the Directive 1999/5/EC.

A detailed R&TTE Declaration of Conformity can be found online at www.siemens-home.com among the additional documents on the product page for your appliance.





Appliance settings

Settings that can be selected:

- **End signal**
off – quiet – medium – loud – very loud
Adjust the volume of the end signal.
- **Button signal**
off – quiet – medium – loud – very loud
Adjust the volume of the button signals.
- **Auto power-off** of the appliance
in 15 – 30 – 60 min – never
The appliance automatically switches off after ... minutes (= 0 kWh energy consumption); to switch on, press the ① main switch button.
Note: If you have Wi-Fi switched on, the automatic switch-off is set to **Never**.
- **Language**
Deutsch
English
...
Change the displayed language.
- **Info: Drum cleaning**
on – off
This instruction reminds you to run a drum-cleaning programme.

To change the appliance settings, press and hold both **Basic Settings 3 sec.** buttons for approx. three seconds.

→ Page 28

Notes

- The settings are retained after the appliance is switched off.
- If the buttons are held down, the settings run through automatically.



Sensors

Automatic load sensing

Depending on the type of fabric and load, the automatic load sensing function optimally adjusts the water consumption and programme duration in each programme.

Unbalanced load detection system

The automatic unbalanced load detection system detects imbalances and ensures even distribution of the laundry by repeatedly starting and stopping drum spinning.

If the laundry is extremely unevenly distributed, the speed is reduced or the spin cycle is not performed for safety reasons.

Note: Place large and small items of laundry evenly in the drum.
→ Page 43, → Page 61

AquaSensor

depending on the model

During the rinse cycle, the AquaSensor checks the degree of turbidity (turbidity is caused by dirt and detergent residue) of the rinsing water. The duration and the number of rinse cycles depend on the turbidity of the water.

Load sensor/display

The load sensor detects the load level in the washing machine when the door is open. This is indicated by the bar filling on the display panel.

Note: In order for the load sensor to fully determine the amount of laundry, the drum must be empty before the washing machine is switched on.

Dosing recommendation

The dosing recommendation indicates a recommended detergent dosage as a percentage, depending on the selected programme and the detected load. The indicated % refers to the dosing recommendation of the detergent manufacturer.

Note: By adhering to the dosing recommendation, you can help look after both the environment and your household budget.



Cleaning and maintenance



Warning

Danger of death!

There is a risk of electric shock if you touch live components. Switch off the appliance and pull out the mains plug.



Warning

Risk of poisoning!

Toxic vapours can be produced by cleaning agents that contain solvents, e.g. cleaning solvent. Do not use cleaning agents that contain solvents.

Caution!

Damage to the appliance

Cleaning agents that contain solvents, e.g. cleaning solvent, can damage surfaces and components in the machine. Do not use cleaning agents that contain solvents.

Prevent detergent residue from building up and odours from forming by following these instructions:

Notes

- Ensure the room in which the washing machine is set up is well ventilated.
- Leave the door and detergent dispenser tray open slightly when the washing machine is not in use.
- Occasionally run a wash using the **Cotton 60 °C** programme and powder detergent.

Machine housing/control panel

- Wipe the housing and the control panel with a soft, damp cloth.
- Remove the detergent residue immediately.
- Do not clean with a water jet.

Drum

Use chlorine-free cleaning agents, do not use steel wool.

If there are odours in the washing machine, or to clean the drum, run the **Drum Clean 90 °C** programme without laundry. Add washing powder.

Descaling

Descaling should not be necessary if the detergent is measured out correctly. However, if it is required, follow the manufacturer's instructions for the descaling agent. Suitable descalers can be obtained via our website or from customer services. → *Page 63*

Detergent drawer and housing

If the washing machine contains detergent or fabric softener residues:

1. Pull out the detergent drawer. Press down the insert and fully remove the drawer.
2. To remove the insert: Push the insert upwards from below with your finger.

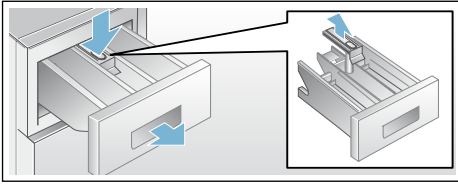

3. Clean the detergent dispenser tray and insert with water and a brush, and dry it. Clean the inside of the housing as well.
4. Fit the insert and lock it in place (push the cylinder onto the guide pin).
5. Push in the detergent drawer.

Note: Leave the detergent drawer open so that any residual water can evaporate.

The drain pump is blocked, emergency draining

Warning **Risk of scalding!**

When you wash at high temperatures, the water gets very hot. If you come into contact with the hot water, you may be scalded.

Allow the water to cool down.

1. Turn off the tap so that no more water can flow in and has to be drained via the drain pump.
2. Switch off the appliance. Pull out the mains plug.
3. Open and remove the service flap.

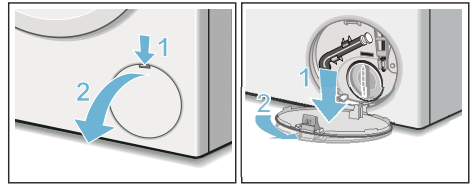

4. Take the drain hose out of the retainer. Remove the sealing cap and pour the water out into a suitable container. Replace the sealing cap and place the drain hose back in the retainer.

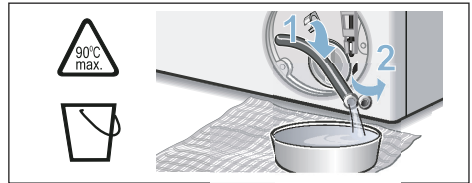

5. Carefully unscrew the pump cover; residual water may leak out. Clean the interior, pump-cover thread and pump housing. The impeller in the drain pump must be able to rotate. Refit the pump cover and screw it on tightly. The handle must be in a vertical position.

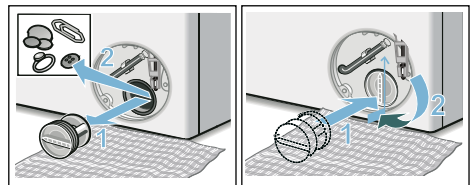

6. Place the service flap back on, lock it into place, and close it.

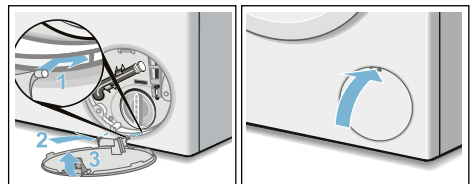

Note: To prevent unused detergent from flowing straight into the drain during the next wash: Pour 1 litre of water into compartment **II** and start the **Drain** programme.

The drain hose at the siphon is blocked

1. Switch off the appliance. Pull out the mains plug.
2. Loosen the hose clamp. Carefully remove the drain hose; residual water may leak out.
3. Clean the drain hose and siphon connecting piece.

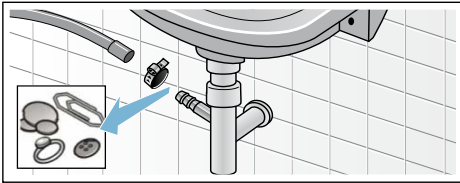

4. Re-attach the drain hose and secure the connection point using the hose clamp.

Filter in the water supply blocked

First, reduce the water pressure in the supply hose:

1. Turn off the tap.
2. Select any programme (except Rinse/Spin/Empty).
3. Press the ►|| button. Allow the programme to run for approximately 40 seconds.
4. Press the ⓪ button. The appliance is switched off.
5. Pull out the mains plug.

Then clean the filter:

1. Disconnect the hose from the tap. Clean the filter with a small brush.

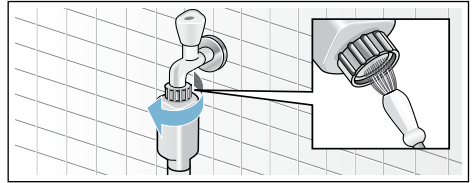

2. For standard and Aqua-Secure models, clean the filter on the rear of the appliance: Remove the hose from the rear of the appliance. Use pliers to remove the filter and then clean it.

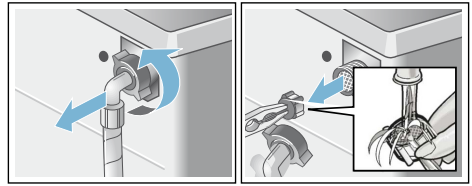

3. Connect the hose and check for leaks.

Faults and what to do about them.

Emergency release

E.g. in the event of a power cut

The programme continues when the power supply is restored.

However, if the laundry has to be removed, the washing machine door can be opened as follows:

Warning

Risk of scalding!

When you are washing at high temperatures, there is a risk of scalding if you come into contact with hot water and laundry.

If possible, leave it to cool down first.

Warning

Risk of injury!

You may injure your hands if you reach into the drum while it is turning.

Do not reach into the drum when it is turning.

Wait until the drum has stopped turning.

Caution!

Water damage

Any escaping water may cause water damage.

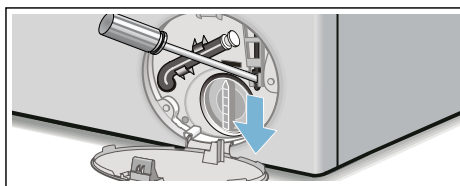

Do not open the door if water can be seen through the glass.

1. Switch off the appliance. Pull out the mains plug.
2. Drain the water. → *Page 57*
3. Pull the emergency release downwards with a tool and release. The door can then be opened.







en Faults and what to do about them.





Information on the display panel

Display	Cause/remedy
Pause: Reload is not possible	Temperature or water level is too high. Press the ► button to continue the programme.
Door cannot be unlocked: Water level or temperature is too high	Temperature or water level is too high. Press the ► button to continue the programme.
The door cannot be locked; please open the door again, then close it and select the ► button	<ul style="list-style-type: none">■ Laundry may be caught. Open and close the door again and press the ► button.■ If necessary, push the door closed or remove some laundry and then push it closed again.■ If necessary, switch the appliance off and on again; set the programme and make your individual settings; start the programme.
Turn on the tap	<ul style="list-style-type: none">■ Turn the tap on fully,■ Supply hose kinked/trapped,■ The water pressure is too low. Clean the filter. → Page 58
Clean the drain pump	<ul style="list-style-type: none">■ The drain pump is blocked. Clean the drain pump. → Page 57■ The drain hose/drain pipe is blocked. Clean the drain hose at the siphon. → Page 58
AquaStop has been activated. Please call the after-sales service	Not applicable on models without AquaStop There is water in the base trough; the appliance is leaking. Turn off the tap. Call the after-sales service.
Auto power-off in ... seconds,	Appliance automatically switches off after ... seconds if it is not operated for a prolonged period. To cancel, press any button. → Page 54
Water cooling	To protect the wastewater pipes, the hot detergent solution is cooled before being drained.
Drum care information:	This instruction reminds you to run the Drum Clean 90 °C programme or a 60 °C programme to clean and care for the drum and the outer tub. Notes <ul style="list-style-type: none">■ Run the programme without laundry.■ Use washing powder or a detergent that contains bleach. To prevent foaming, only use half the amount of detergent recommended by the detergent manufacturer. Do not use detergents intended for woollens or delicates.■ Switch reminder information on/off. → Page 54
	Remote start selected. → Page 48
	Off: Wi-Fi is switched off and the appliance is not connected to your home network. Flashing: The appliance is trying to connect to your home network. Lit: Wi-Fi is switched on and the appliance is connected to your home network.
Other displays Error E:XXX	Switch off the appliance, wait for five seconds and then switch it on again. If the display appears again, call the after-sales service.

Faults and what to do about them.

Faults	Cause/remedy
Water is leaking from the machine.	<ul style="list-style-type: none"> ■ Attach the drain hose correctly or replace it. ■ Tighten the threaded joint on the supply hose.
The appliance is not filling with water.	<ul style="list-style-type: none"> ■ Have you pressed the ► button? ■ Is the tap turned on?
Detergent is not being dispensed.	<ul style="list-style-type: none"> ■ Could the filter be clogged? Clean the filter. → Page 58 ■ Is the supply hose kinked or trapped?
The door will not open.	<ul style="list-style-type: none"> ■ The safety function is activated. Stop the programme? → Page 47 ■ Is the  childproof lock activated? Deactivate. → Page 46 ■ Is  selected (Rinse Stop = no final spin)? → Page 47 ■ Can the door only be opened by the emergency release? → Page 59
The programme does not start.	<ul style="list-style-type: none"> ■ Have you pressed the ► or Finish in button? ■ Is the door closed? ■ Is the  childproof lock activated? Deactivate. → Page 46
The drum briefly jerks or judders after the programme has started.	Not a fault – the internal motor test may cause the drum to jerk or judder briefly when the wash programme starts.
The water is not draining.	<ul style="list-style-type: none"> ■ Is  selected (Rinse Stop = no final spin)? → Page 47 ■ Clean the drain pump. → Page 57 ■ Clean the drain pipe and/or the drain hose.
Water is not visible in the drum.	Not a fault – the water is below the visible area.
The spin result is not satisfactory. Laundry wet/too damp.	<ul style="list-style-type: none"> ■ Not a fault – the unbalanced load detection system has interrupted the spin cycle because the laundry is unevenly distributed. Distribute small and large items of laundry evenly in the drum. ■ Is Less Ironing selected (depending on the model)? → Page 39 ■ Is the selected speed too low? → Page 38
The appliance restarts the spin cycle several times.	Not a fault – the unbalanced load detection system is adjusting an imbalance.
The programme is taking longer than usual.	<ul style="list-style-type: none"> ■ Not a fault – the unbalanced load detection system is adjusting an imbalance by repeatedly redistributing the laundry. ■ Not a fault – the foam detection system is active – a rinse cycle has been switched on.
The length of the programme changes during the wash cycle.	Not a fault – the programme sequence is optimised for the specific washing process. This may change the length of the programme shown on the display panel.
Water remaining in the care-product compartment  .	<ul style="list-style-type: none"> ■ Not a fault – the effectiveness of the care product is not affected. ■ Clean the insert if necessary. → Page 57

en Faults and what to do about them.

Faults	Cause/remedy
Odours in the washing machine.	Run the Drum Clean 90 °C or Cotton 90 °C programme without laundry. Add standard washing powder or a detergent that contains bleach. Note: . To prevent foaming, only use half the amount of detergent recommended by the detergent manufacturer. Do not use detergents that are intended for woollens or delicates.
The  symbol is lit in the display panel. Foam may also be leaking from the detergent drawer.	Have you used too much detergent? Mix one tablespoon of fabric softener with 1/2 litre of water and pour it into compartment II (not suitable for outdoor clothing, sportswear or items made with down). Use less detergent for the next wash cycle.
 in the display panel	Wi-Fi is switched on but the connection to the home network could not be established. Check whether your home network is available or reconnect to the home network.
Home Connect is not working.	You can find solutions to problems with Home Connect at www.home-connect.com .
Loud noises, vibrations and machine "wandering" during the spin cycle.	<ul style="list-style-type: none"> ■ Is the appliance level? Level the appliance. → <i>Page 20</i> ■ Are the appliance's feet secured? Secure the appliance's feet. → <i>Page 20</i> ■ Have the transport locks been removed? Remove the transport locks. → <i>Page 16</i>
The display panel/indicator lights do not work while the appliance is running.	<ul style="list-style-type: none"> ■ Has there been a power failure? ■ Have the fuses blown/has the circuit breaker tripped? Switch on the circuit breaker/replace the fuses. ■ If the fault occurs repeatedly, call the after-sales service.
There is detergent residue on the laundry.	<ul style="list-style-type: none"> ■ Some phosphate-free detergents contain water-insoluble residue. ■ Select Rinse or brush the laundry after washing.
In the "Reload" status,  flashes very quickly and a signal sounds.	<ul style="list-style-type: none"> ■ The water level is too high. It is not possible to add laundry. Close the door immediately, if necessary. ■ Press the  button to resume the programme.
If you cannot rectify a fault yourself (after switching the machine off and on again) or a repair is required:	
<ul style="list-style-type: none"> ■ Switch off the appliance and pull the mains plug out of the socket. ■ Turn off the tap and call the after-sales service. 	



After-sales service

If you cannot rectify a fault yourself, contact customer services. → Cover page

We will always find an appropriate solution in order to avoid unnecessary visits by engineers.

Please give customer services the product number (E no.) and the production number (FD) of the appliance.

E-Nr. _____	FD _____
-------------	----------

E no.	Product number
FD	Production number

You can find this information
*depending on the model:

On the inside of the door*/in the opened service flap* and on the rear of the appliance.

Trust the expertise of the manufacturer.

Contact us for assistance. By doing so, you will ensure that the repairs are carried out by trained service personnel using genuine spare parts.



Consumption rates

Energy and water consumption, programme duration and residual moisture for the main washing programmes

(approximate values)

Programme	Load	Energy consumption*	Water consumption*	Programme duration*
Cotton 20 °C	9 kg	0,25 kWh	90 l	2 ¾ h
Cotton 40 °C	9 kg	1,10 kWh	90 l	3 h
Cotton 60 °C	9 kg	1,06 kWh	90 l	2 ¾ h
Cotton 90 °C	9 kg	2,14 kWh	100 l	2 ¾ h
Easy-Care 40 °C	4 kg	0,64 kWh	71 l	2 h
Mixed Fabrics 40 °C	4 kg	0,60 kWh	45 l	1 ¼ h
Delicates / Silk 30 °C	2 kg	0,19 kWh	37 l	¾ h
Wool 30 °C	2 kg	0,19 kWh	41 l	¾ h

Programme	Approximate information on the residual moisture**			
	WM6... / WMH6...	WM4... / WMH4...	WM2... / WMH2...	WMO... / WMH0...
	Max. 1600 rpm	Max. 1400 rpm	Max. 1200 rpm	Max. 1000 rpm
Cotton	44%	48%	53%	62%
Easy-Care	40%	40%	40%	40%
Delicates / Silk	30%	30%	30%	30%
Wool	45%	45%	45%	45%







* Observed values may deviate from the indicated values due to influence of water pressure, hardness and inlet temperature, ambient temperature, type, amount and soiling of laundry, detergent used, fluctuations in power supply and selected additional functions.

** Information on residual moisture based on programme-dependent spin-speed limit and maximum loads.

Efficiency test programmes for cotton fabrics

The following programmes (standard programmes, indicated by ) are suitable for cleaning normally soiled cotton fabrics and are the most efficient with respect to combined energy and water consumption.

Standard programmes for cottons in accordance with Regulation (EU) no. 1015/2010

Programme + temperature	Load	Approximate programme duration
Cotton Eco  + 	9 kg	4 ¾ h
Cotton Eco  + 	4,5 kg	4 ½ h
Cotton Eco  + 	4,5 kg	4 ½ h

Programme setting at maximum speed for testing and energy labelling in accordance with Directive 2010/30/EU with cold water (15 °C).
The stated programme temperature is based on the temperature indicated on the care label in the laundry items. The actual washing temperature may differ from the stated programme temperature for energy-saving reasons; the washing performance corresponds to the selected temperature.

Technical data

Dimensions:

850 x 600 x 590 mm

(height x width x depth)

Weight:

70-85 kg (depending on the model)

Mains connection:

Mains voltage 220-240 V/50 Hz

Nominal current 10 A

Nominal power 1900-2300 W

Water pressure:

100-1000 kPa (1-10 bar)

Power consumption when switched

off:

0,12 W

Power consumption when it is left on:

0,43 W

Power consumption when networked (Wi-Fi) in standby mode/duration:

3,6 W / 15 Min.



Aqua-Stop warranty

Only for appliances with Aqua-Stop

In addition to warranty claims against the vendor based on the purchase agreement and to our appliance warranty, we will provide compensation under the following conditions:

1. If water damage is caused due to a fault in our Aqua-Stop system, we will compensate domestic customers for the damage caused.
2. The liability guarantee is valid for the service life of the appliance.
3. It is a prerequisite of all warranty claims that the appliance with Aqua-Stop must have been installed and connected correctly in accordance with our instructions; this also includes a correctly fitted Aqua-Stop extension (genuine accessories). Our warranty does not cover defective feed lines or fittings leading to the Aqua-Stop connection at the tap.
4. Appliances with Aqua-Stop do not need to be supervised during operation, nor secured afterwards by turning off the tap.

The tap only needs to be turned off if you are away from home for a long period, e.g. for several weeks' holiday.

Repair order and advice in the event of faults

GB 0344 892 8999 (Calls charged at local or mobile rate.)

IE 01450 2655 (0.03 € per minute at peak. Off peak 0.0088 € per minute.)

You can find the contact information for all countries in the attached after-sales service directory.

BSH Hausgeräte GmbH

Carl-Wery-Straße 34

81739 München

GERMANY

siemens-home.com

Manufactured by BSH Hausgeräte GmbH under Trademark License of Siemens AG



9001178920 (9603)