



Register your new Bosch now:  
[www.bosch-home.com/welcome](http://www.bosch-home.com/welcome)



**Washing machine**  
**WAW28790IL**



**BOSCH**

**en** Instruction Manual and Installation Instructions

## Your new washing machine

You have chosen a Bosch washing machine.

Please take a few minutes to read and become familiar with the advantages of your washing machine.

To meet the high quality demands required by Bosch, every washing machine that leaves our factory is carefully checked to ensure that it functions correctly and is in perfect condition.

For more information on our products, accessories, replacement parts and services, see our website [www.bosch-home.com](http://www.bosch-home.com) or contact our after-sales service centres.

If the operating and installation instructions describe different models, any differences will be pointed out at the relevant points in the text.



Read these operating and installation instructions before switching on the washing machine.

## Display rules

### **Warning!**

This combination of symbol and signal word indicates a possibly dangerous situation. Not heeding the warning can cause death or injuries.

### **Caution!**

This signal word indicates a possibly dangerous situation. Not heeding the caution can cause property and/or environmental damage.

### **Note/tip**

Information about the optimum use of the appliance/any other useful information.















### **1. 2. 3. / a) b) c)**











The steps are represented by numbers or letters.

■ / -

Lists are represented by a small box or a dash.

# Contents

 <b>Intended use</b> . . . . .	5	 <b>Laundry</b> . . . . .	28
 <b>Safety instructions</b> . . . . .	6	Prepare the laundry . . . . .	28
Children/people/pets . . . . .	6	Sorting laundry . . . . .	28
Installation . . . . .	7	 <b>Detergent</b> . . . . .	29
Operation . . . . .	10	Correct selection of detergent . . . . .	29
Cleaning/Maintenance . . . . .	11	Saving energy and detergent . . . . .	29
 <b>Environmental protection</b> . . . . .	13	 <b>Overview of programmes</b> . . . . .	30
Packaging/used appliance . . . . .	13	Programmes on the programme selector . . . . .	30
Tips on economical use . . . . .	13	ActiveOxygen Refresh  . . . . .	35
 <b>Positioning and connecting</b> . . . . .	14	Starching . . . . .	35
Included with the appliance . . . . .	14	Dyeing/bleaching . . . . .	35
Safety instructions . . . . .	15	Soaking . . . . .	35
Installation surface . . . . .	15	 <b>Programme default settings</b> . . . . .	36
Installation on a base or a wooden joist floor . . . . .	15	Temperature °C . . . . .	36
Installation on a platform with drawer . . . . .	15	Spin speed . . . . .	36
Installing the appliance in a kitchenette . . . . .	16	Ready in . . . . .	36
Removing the transport locks . . . . .	16	 <b>Additional programme settings</b> . . . . .	37
Hose and cable lengths . . . . .	17	SpeedPerfect  . . . . .	37
Water inlet . . . . .	18	EcoPerfect  . . . . .	37
Water outlet . . . . .	19	Prewash . . . . .	37
Levelling . . . . .	20	Water Plus . . . . .	37
Electrical connection . . . . .	21	Easy Iron . . . . .	37
Before using the appliance for the first time . . . . .	22	Active Oxygen  . . . . .	37
Transportation . . . . .	23	 <b>Main points in brief</b> . . . . .	24
 <b>Getting to know the appliance</b> . . . . .	25	Washing machine . . . . .	25
Washing machine . . . . .	25	Control panel . . . . .	26
Control panel . . . . .	26	Display panel . . . . .	27
Display panel . . . . .	27		

	<b>Operating the appliance. . . . .</b>	<b>38</b>
	Preparing the washing machine . . .	38
	Switching on the appliance/ selecting a programme . . . . .	38
	Placing laundry into the drum . . . .	38
	Measure and add detergent and care products . . . . .	39
	Change the programme default settings . . . . .	40
	Select additional programme settings . . . . .	40
	Start the programme . . . . .	40
	Child lock.  3 sec. . . . .	40
	Adding laundry . . . . .	41
	Changing the programme . . . . .	41
	Cancel the programme . . . . .	41
	Programme end during rinse hold. .	41
	Programme end. . . . .	42
	Removing laundry/switching off the appliance. . . . .	42
	<b>Appliance settings . . . . .</b>	<b>43</b>
	Activating the setting mode . . . . .	43
	Changing the signal volume . . . . .	43
	Selecting/deselecting the appliance automatic switch-off. . . . .	43
	Switching the drum-care information signal on/off . . . . .	43
	Exiting setting mode . . . . .	43
	<b>Sensors . . . . .</b>	<b>44</b>
	Automatic load sensing. . . . .	44
	Unbalanced load detection system .	44
	AquaSensor. . . . .	44
	<b>Cleaning and maintenance . . .</b>	<b>45</b>
	Machine housing/control panel. . . .	45
	Drum . . . . .	45
	Descaling. . . . .	45
	Detergent drawer and housing . . . .	46
	The drain pump is blocked, emergency draining. . . . .	46
	The drain hose at the siphon is blocked . . . . .	47
	Filter in the water supply blocked . .	47
	<b>Faults and what to do about them. . . . .</b>	<b>48</b>
	Emergency release. . . . .	48
	Information on the display panel . . .	49
	Faults and what to do about them. . .	50
	<b>After-sales service . . . . .</b>	<b>52</b>
	<b>Consumption rates. . . . .</b>	<b>53</b>
	Energy and water consumption, programme duration and residual moisture for the main washing programmes. . . . .	53
	<b>Technical data. . . . .</b>	<b>54</b>
	<b>Aqua-Stop warranty . . . . .</b>	<b>55</b>



## Intended use

- This appliance is intended for private domestic use only.
- Do not install or operate this appliance anywhere that is liable to experience frost and/or outdoor conditions. There is a risk that the appliance will be damaged if residual water in it freezes. If hoses freeze up, they may crack/burst.
- This appliance must only be used for washing domestic laundry, consisting of machine-washable items and hand-washable woollens (see label on item). Using the appliance for any other purpose is outside of the scope of its intended application and is forbidden.
- This appliance is suitable for operation with cold mains water and commercially available detergents and care products (must be suitable for use in washing machines).
- This appliance is intended for use up to a maximum height of 4000 metres above sea level.

### **Before you switch on the appliance:**

Check that there is no visible damage to the appliance. Do not operate the appliance if it is damaged. Should you have any problems, please contact your specialist dealer or our customer service.

Read and follow the operating and installation instructions and all other information provided with this appliance.

Retain the documents for subsequent use or for subsequent owners.

## Safety instructions

The following safety information and warnings are provided to protect you from injury and to prevent material damage to your surroundings.

It is nevertheless important to take the necessary precautions and to proceed with care when installing, maintaining, cleaning and operating the appliance.

### Children/people/pets

#### **Warning** **Risk of death!**

Children and other people who are unable to assess the risks involved when using the appliance may injure themselves or may find themselves in life-threatening situations. Therefore please note:

- The appliance may be used by children over the age of 8 years and by persons with reduced physical, sensory or mental capacity or by persons with a lack of experience or knowledge as long as they are supervised or have received instruction on how to use the appliance safely and they have understood the potential risks of using the appliance.
- Children must not play with this appliance.

- Do not allow children to clean or maintain this appliance unsupervised.
- Keep children under 3 years and pets away from this appliance.
- Do not leave the appliance unattended when children or other people who are unable to assess the risks are in the vicinity.

#### **Warning** **Risk of death!**

Children may lock themselves inside appliances and find themselves in a life-threatening situation.

- Do not position the appliance behind a door, as this may obstruct the appliance door or prevent it from opening completely.
- Once an appliance has reached the end of its life, pull the mains plug from the socket **before** severing the mains cable, and then destroy the lock on the appliance door.

**⚠ Warning****Risk of suffocation!**

If allowed to play with the packaging/plastic film or packing components, children may become caught in these or pull them over their heads and suffocate.

Keep packaging, plastic film and packing components away from children.

**⚠ Warning****Risk of poisoning!**

Detergents and care products may result in poisoning if consumed.

If accidentally swallowed, seek medical advice. Keep detergents and care products out of the reach of children.

**⚠ Warning****Risk of burns!**

When washing at high temperatures, the glass in the appliance door becomes hot. Stop children from touching the appliance door when it is hot.

**⚠ Warning****Eye/skin irritation!**

Contact with detergents or care products may cause eye/skin irritation.

Rinse eyes/skin thoroughly if they/it come(s) into contact with detergents or care products. Keep detergents and care products out of the reach of children.

**Installation****⚠ Warning****Risk of electric shock/fire/material damage/damage to the appliance!**

If the appliance is not installed properly, this may lead to a dangerous situation. Make sure that:

- The mains voltage on your power socket matches the rated voltage specified on the appliance (identification plate). The connected loads and the required fuse protection are specified on the identification plate.
- The appliance is only connected to a source of alternating current via a nationally recognized and grounded outlet that has been correctly installed.
- The mains plug and the grounded socket match and the earthing system has been correctly installed.
- The cross section of the cable is sufficiently large enough.
- The mains plug is accessible at all times.
- If using a residual current circuit breaker, only use one that bears the following mark: . The presence of this mark is the only way to be sure that it fulfils all the applicable regulations.

**⚠ Warning**

**Risk of electric shock/fire/  
material damage/damage to  
the appliance!**

If the appliance's mains cable is altered or damaged, this may result in electric shock, short circuiting or fire due to overheating.

The mains cable must not be kinked, crushed or altered, and must not come into contact with any heat sources.

**⚠ Warning**

**Risk of fire/material damage/  
damage to the appliance!**

The use of extension cords or power strips may result in fire due to overheating or short circuiting.

Connect the appliance directly to an earthed socket that has been correctly installed. Do not use extension cords, power strips or multi-way couplers.

**⚠ Warning**

**Risk of injury/material  
damage/damage to the  
appliance!**

- The appliance may vibrate or move when in operation, potentially resulting in injury or material damage.  
Place the appliance on a clean, even, solid surface and, using a spirit level to guide you, level it with the screw-in feet.

- If you take hold of any of the appliance's protruding parts (e.g. the appliance door) in order to lift or move it, these parts may break off and cause injury.

Do not take hold of any of the appliance's protruding parts in order to move the appliance.

**⚠ Warning**

**Risk of injury!**

- The appliance is very heavy. Lifting it may result in injury. Do not lift the appliance on your own.
- The appliance has sharp edges on which you could cut your hands. Do not take hold of the appliance by its sharp edges. Wear protective gloves to lift it.
- If the hoses and mains cables are not correctly routed, they may constitute a tripping hazard, which may result in injury. Route hoses and cables such that they do not constitute a tripping hazard.



**Caution!****Material damage/damage to the appliance**

- If the water pressure is too high or too low, the appliance may not be able to operate properly, and it may also result in material damage or damage to the appliance.  
Make sure that the water pressure in the water supply facility is at least 100 kPa (1 bar), and does not exceed 1000 kPa (10 bar).
- If the water hoses are altered or damaged, this may result in material damage or damage to the appliance. The water hoses must not be kinked, crushed, altered or severed.
- The use of hoses supplied by other brands to connect to the water supply may result in material damage or damage to the appliance. Use the hoses supplied with the appliance or genuine spare part hoses only.
- The appliance is secured for transportation by transport locking devices. If the transport locking devices are not removed before the appliance is operated, this may result in damage to the appliance.  
It is important to completely remove all transport locking devices before using the appliance for the first time. Make sure that you retain these transport locking devices separately. It is important to refit the transport locking devices if the appliance is to be transported, in order to prevent the appliance from being damaged in transit.

## Operation

### **Warning**

#### **Risk of explosions/fire!**

Laundry that has been pretreated with cleaning agents that contain solvents, e.g. stain remover/cleaning solvent, may cause an explosion in the drum. Rinse the laundry thoroughly with water before washing it in the machine.

### **Warning**

#### **Risk of poisoning!**

Poisonous fumes may be given off by cleaning agents that contain solvents, e.g. cleaning solvent.

Do not use cleaning agents that contain solvents.

### **Warning**

#### **Risk of injury!**

- If you support your weight/sit on the appliance door when it is open, the appliance may tip over, which may result in injury.

Do not support your weight on the appliance door when it is open.

- If you climb onto the appliance, the worktop may break, which may result in injury.

Do not climb onto the appliance.

- If you reach into the drum while it is still rotating, you risk injuring your hands. Wait until the drum has stopped rotating.

### **Warning**

#### **Risk of scalding!**

When washing at high temperatures, there is a risk of scalding if you come into contact with hot detergent solution (e.g. when draining hot detergent solution into a washbasin).

Do not reach into the hot detergent solution.

### **Warning**

#### **Irritation of the respiratory tract/eyes!**

This appliance runs programmes that use active oxygen. Active oxygen can irritate the mucosa and cause eyes to water.

Do not open the door using the emergency release if a programme is running with active oxygen. Wait until the door has been released.

**⚠ Warning****Eye/skin irritation!**

Detergent and care products may spray out if the detergent drawer is opened while the appliance is in operation. Rinse eyes/skin thoroughly if they/it come(s) into contact with detergents or care products. If accidentally swallowed, seek medical advice.

**Caution!****Material damage/damage to the appliance**

- If the amount of laundry in the appliance exceeds its maximum load capacity, it may not be able to operate properly, or this may result in material damage or damage to the appliance.  
Do not exceed the maximum load capacity of dry laundry. Make sure you comply with the maximum load capacities specified for each of the programs. → *Page 30*
- If you pour the wrong quantity of detergent or cleaning agent into the appliance, this may result in material damage or damage to the appliance.  
Use detergents/care products/cleaning agents and softeners in accordance with the manufacturers' instructions.

**Cleaning/Maintenance****⚠ Warning****Danger of death!**

The appliance is powered by electricity. There is a risk of electric shock if you come into contact with live components. Therefore please note:

- Switch off the appliance. Disconnect the appliance from the power supply (pull out the plug).
- Never take hold of the mains plug with wet hands.
- When removing the mains plug from the socket, always take hold of the plug itself and never the mains cable, otherwise this may damage the mains cable.
- Do not make any technical modifications to the appliance or its features.
- Repairs and any other work on the appliance must only be conducted by our customer service or by an electrician. The same applies for replacing the mains cable (when necessary).
- Spare mains cables can be ordered from our customer service.

 **Warning**

**Risk of poisoning!**

Poisonous fumes may be given off by cleaning agents that contain solvents, e.g. cleaning solvent.

Do not use cleaning agents that contain solvents.

 **Warning**

**Risk of electric shock/material damage/damage to the appliance!**

If moisture penetrates the appliance, this may cause it to short circuit.

Do not use a pressure washer or steam cleaner to clean your appliance.

 **Warning**

**Risk of injury/material damage/damage to the appliance!**

The use of spare parts and accessories supplied by other brands is dangerous and may result in injury, material damage or damage to the appliance.

For safety reasons, use genuine spare parts and accessories only.

**Caution!**

**Material damage/damage to the appliance**

Cleaning agents and agents for pretreating laundry (e.g. stain removers, prewash sprays, etc.) may cause damage if they come into contact with the surfaces of the appliance. Therefore please note:

- Do not allow these agents to come into contact with the surfaces of the appliance.
- Clean the appliance with nothing but water and a soft, damp cloth.
- Remove any detergent, spray or other residues immediately.



## Environmental protection

### Packaging/used appliance



Dispose of packaging in an environmentally-responsible manner.

This appliance is labelled in accordance with European Directive 2012/19/EU concerning used electrical and electronic appliances (waste electrical and electronic equipment - WEEE).

The guideline determines the framework for the return and recycling of used appliances as applicable throughout the EU.

### Tips on economical use

- Always fill the appliance with the maximum amount of laundry for the relevant programme.  
Overview of programmes  
→ *Page 30*
  - Wash normally soiled laundry without a prewash.
  - Save energy and detergent when washing lightly and normally soiled laundry. → *Page 29*
  - The selectable temperatures apply to the care labels on the textiles. The temperatures in the machine may deviate from this so that you get the optimum mix of energy-saving and washing results.
- **Information on energy and water consumption:** → *Page 27*  
The displays provide information about the relative level of energy and water consumption in the selected programmes.  
The more indicator lights light up, the higher the programme's consumption.  
This enables you to compare the consumption levels of the different programmes when choosing your programme settings and decide on an energy- and water-saving programme setting.
  - **Energy-saving mode:** The display panel lighting goes out after a few minutes and the  button flashes. Press any button to activate the lighting.  
Energy-saving mode is not activated if a programme is running.
  - **Automatic switch off:** If the appliance is not operated for a prolonged period, it may automatically switch off before the programme starts and when the programme has ended to save energy. Press the main switch again to switch on the appliance. Switching the → *Page 43* function on/off
  - If the laundry is subsequently dried in a tumble dryer, select the spin speed according to the tumble dryer manufacturer's instructions.



## Positioning and connecting

### Included with the appliance

**Note:** Check the machine for transport damage. Never use a damaged machine. If you have any complaints, contact the dealer from whom you purchased the appliance or our customer services. → Page 52

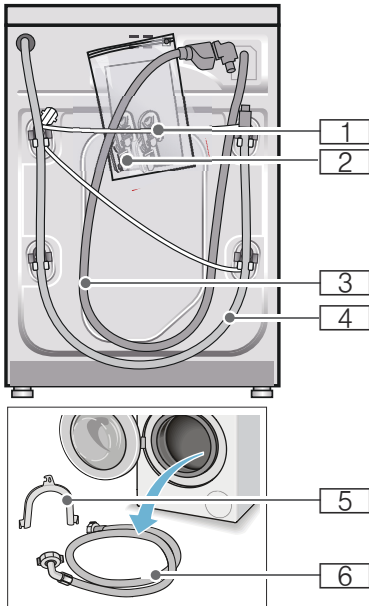

- 1 Mains cable
  - 2 Bag:
    - Installation and operating instructions
    - Customer services location directory\*
    - Warranty\*
    - Cover caps for openings after the transport braces have been removed
    - Adaptor with sealing washer from 21 mm = 1/2" to 26.4 mm = 3/4"\*
  - 3 Water supply hose on Aqua-Stop models
  - 4 Water drain hose
  - 5 Elbow for securing the water drain hose\*
  - 6 Water supply hose on standard/Aqua-Secure models
- \* depending on the model

**In addition**, a hose clamp (24 - 40 mm diameter, available from specialist dealers) is required to connect the water drain hose to a siphon.

### Useful tools

- Spirit level for aligning
- Spanner with:
  - WAF13 for loosening the transport braces, and
  - WAF17 for aligning the appliance feet

## Safety instructions

### **Warning**

#### **Risk of injury!**

- The washing machine is very heavy. Be careful when lifting/transporting the washing machine.
- When the washing machine is lifted by its protruding parts (e.g. the washing machine door), the components may break off and cause injuries. Do not lift the washing machine by protruding parts.
- If the hose and mains cables are not routed properly, there is a risk of tripping and injury. Lay hoses and cables in such a way that there is no risk of tripping.

### **Caution!**

#### **Damage to the appliance**

Frozen hoses may rip/burst. Do not install the washing machine in areas exposed to frost or outdoors.

### **Caution!**

#### **Water damage**

The connection points for the water supply hose and water drain hose are under high water pressure. To prevent leaks and water damage, you must follow the instructions in this section.

### **Notes**

- In addition to the safety information listed here, the local water and electricity supplier may have special requirements.
- If in doubt, have the appliance connected by a specialist.

## Installation surface

**Note:** The washing machine be stable so that it does not move around.

- The installation surface must be firm and level.
- Soft floors/floor coverings are not suitable.

## Installation on a base or a wooden joist floor

### **Caution!**

#### **Damage to the appliance**

The washing machine may "wander" and tip/topple from the base when spinning.

The feet of the appliance must be secured with holding brackets. Order no. WMZ 2200, WX 9756, Z 7080X0

**Note:** On wooden joist floors, install the washing machine:

- In a corner, if possible,
- On a water-resistant wooden board (min. 30 mm thick) which is screwed tightly to the floor.

## Installation on a platform with drawer

Platform order no.: WMZ 20490, WZ 20490, WZ 20510, WZ 20520

## Installing the appliance in a kitchenette

### **Warning** **Danger of death!**

There is a risk of electric shock if you touch live components. Do not remove the appliance covering plate.

### Notes

- Recess width of 60 cm required.
- Only install the washing machine underneath a continuous worktop that is securely connected to adjacent cabinets.

## Removing the transport locks

### **Caution!** **Damage to the appliance**

- The machine is secured for transportation using transport locks. If the transport locks are not removed, the drum, for example, may become damaged when the machine is operated. Before using the appliance for the first time, make sure that you completely remove all four transport locks. Keep the locks in a safe place.
- To prevent transport damage from occurring if the appliance is moved at a later date, you must refit the transport locks before transporting the appliance.

**Note:** Keep the screws and sleeves in a safe place.

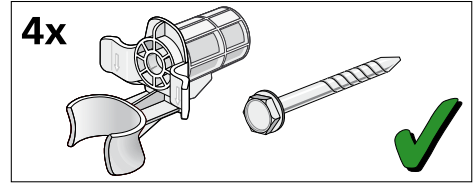

1. Take the hoses out of the holders.

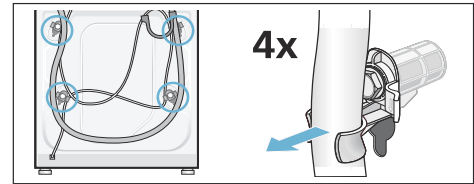

2. Unscrew and remove all four transportation securing bolts with a wrench (WAF 13). Remove the sleeves. Remove the mains cable from the holders.

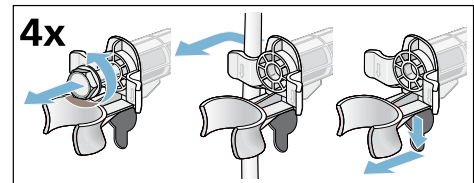

3. Insert the covers. Lock the covers firmly in place by applying pressure to the snap-in hooks.

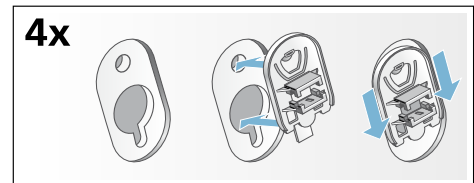



## Hose and cable lengths

### ■ Left-hand connection

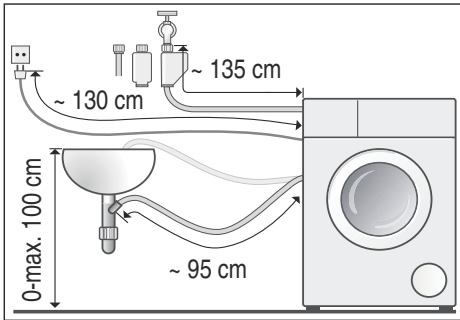

### ■ Right-hand connection

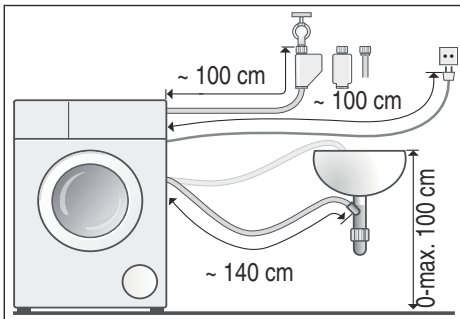

**Tip:** The following are available from specialist dealers/customer services:

- Extension for Aqua-Stop and cold water supply hose (approx. 2.50 m); order no. WM Z2380, WZ 10130, CZ 11350, Z 7070X0
- A longer supply hose (approx. 2.20 m) for standard models; individual component number for customer services: 00353925

## Water inlet

### **Warning** **Danger of death!**

There is a risk of electric shock if you touch live components.  
Do not immerse the Aqua-Stop safety valve in water (it contains an electric valve).

### Notes

- Only operate the washing machine using cold mains water.
- Do not connect the machine to the mixer tap of an unpressurised hot-water boiler.
- Do not use a used supply hose. Only use the supply hose supplied or one that was purchased from an authorised specialist retailer.
- Do not kink or squash the water supply hose.
- Do not alter (shorten, cut through) the water supply hose (otherwise its strength is no longer guaranteed).
- Only tighten the screw connections by hand. If the screw connections are tightened too much with a tool (pliers), the thread may become damaged.
- When connecting to a 21 mm = 1/2" tap, first fit an adapter\* with a sealing washer from 21 mm = 1/2" to 26.4 mm = 3/4".  
\*supplied depending on the model

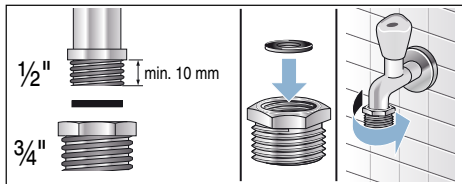

### Optimum water pressure in the supply network

**At least** 100 kPa (1 bar)

**Maximum** 1000 kPa (10 bar)

When the tap is open, the water flow rate is at least 8 l/min.

If the water pressure is higher than this, a pressure-reducing valve must be installed.

### Connection

Connect the water supply hose to the tap (26.4 mm = 3/4") and to the appliance (not necessary for Aqua-Stop models as this is permanently installed):

#### ■ Model: **Standard**

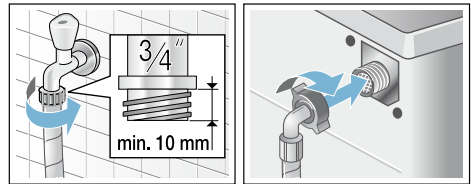

#### ■ Model: **Aqua-Secure**

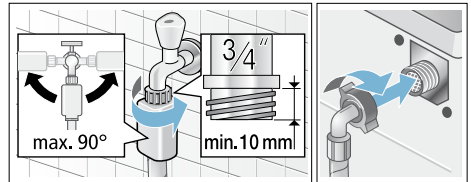

#### ■ Model: **Aqua-Stop**

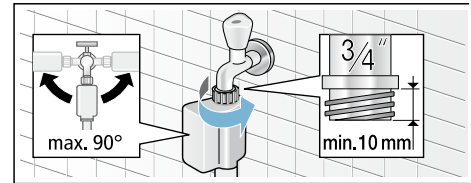

**Note:** Turn on the tap carefully, checking the leak tightness of the connection points. The screw connection is under mains water pressure.

## Water outlet

### Warning

#### Risk of scalding!

When you are washing at high temperatures, there is a risk of scalding if you come into contact with hot water (e.g. when draining hot water into a washbasin).

Do not reach into the hot water.

### Caution!

#### Water damage

If the drain hose slips out of the washbasin or the connection point during draining due to high water pressure, any escaping water may cause water damage.

Secure the drain hose so that it cannot slip out.

### Caution!

#### Damage to the appliance/fabrics

If the end of the drain hose is immersed in the drained water, water may be sucked back into the appliance and may damage the appliance/fabrics.

Make sure that:

- The plug does not block drainage from the washbasin.
- The end of the drain hose is not immersed in the drained water.
- The water drains away quickly enough.

**Note:** Do not kink the water drain hose or put strain on it lengthways.

## Connection

### ■ Drainage into a washbasin

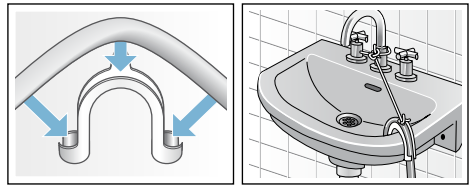

### ■ Drainage into a siphon

The connection point must be secured using a hose clamp with a diameter of 24 - 40 mm (available from specialist dealers).

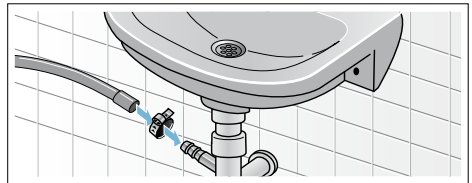

### ■ Drainage into a plastic pipe with rubber bushing or into a drainage pit

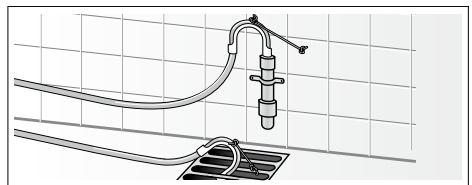

## Levelling

Align the appliance using a spirit level.

Incorrect alignment may result in loud noises, vibrations and machine "movement".

1. Loosen the lock nuts using a WAF17 spanner, by turning it in a clockwise direction.
2. Check the alignment of the washing machine with a spirit level, and adjust it if necessary. Change the height by turning the appliance feet. All four appliance feet must stand firmly on the ground.
3. The lock nuts on all four appliance feet must be screwed tightly against the housing using a suitable WAF17 spanner. In doing so, hold the foot tight and do not adjust its height.



## Electrical connection

### Warning

#### Danger of death!

There is a risk of electric shock if you touch live components.

- Never touch or hold the mains plug with wet hands.
- Only pull out the mains cable by the plug and never by the cable, as this could damage it.
- Never unplug the mains plug during operation.

Observe the following information and ensure that:

#### Notes

- The mains voltage and voltage indicated on the washing machine (rating plate) are the same. The connected load and fuse required are specified on the rating plate.
- The washing machine is only connected to an alternating current supply via a properly installed earthed socket.
- The mains plug fits the socket.
- The cable cross-section is adequate.
- The earthing system is properly installed.
- The mains cable is only replaced by a qualified electrician (if this is necessary). Replacement mains cables are available from customer services.
- No multiple plugs/couplings or extension cables are used.
- If an earth-leakage circuit breaker is used, only a type which displays the  symbol is used. Only this symbol guarantees compliance with the currently applicable regulations.

- The mains plug can be accessed at all times.
- The mains cable is not kinked, squashed, altered or cut through.
- The mains cable does not come into contact with heat sources.

## Before using the appliance for the first time

The washing machine was thoroughly tested before leaving the factory. To remove any water that may be left over from the test, run the first wash cycle **without** any laundry.



### Notes

- The washing machine **must be correctly installed and connected.**  
From → *Page 14*
- Never use a machine if it is damaged. Inform the after-sales service.

### Preparatory work:

1. Check the machine.
2. Remove the protective film from the control panel.
3. Plug in the mains plug.
4. Turn on the tap.

### Running the programme without laundry:

1. Switch on the appliance.
2. Close the door (do not load any laundry).
3. Set the  **Drum Clean 90 °C** programme.
4. Open the detergent drawer.
5. Pour approximately 1 litre of water into compartment **II**.
6. Pour standard washing powder into compartment **II**.  
**Note:** To prevent foaming, only use half the amount of detergent recommended by the detergent manufacturer. Do not use detergents intended for woollens or delicates.
7. Close the detergent drawer.
8. Press the  button.
9. Switch off the appliance at the end of the programme.

**Your washing machine is now ready to use.**

## Transportation

E.g. when moving house

### Preparatory work:

1. Turn off the tap.
2. Reduce the water pressure in the supply hose: → *Page 47*; Cleaning and maintenance – filter in the water supply blocked
3. Disconnect the washing machine from the mains.
4. Drain the remaining water: → *Page 46*; cleaning and maintenance – the drain pump is blocked, emergency draining
5. Remove the hoses.

### Fitting the transportation securing means:

1. Remove the covers and keep them in a safe place.  
If required, use a screwdriver.

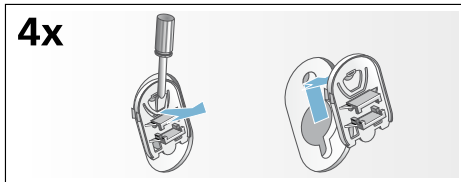

2. Insert all four sleeves.  
Clip the mains cable securely in the holders. Insert the transportation securing bolts and tighten them with a wrench (WAF 13).

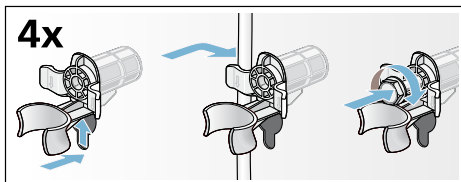









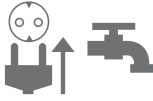
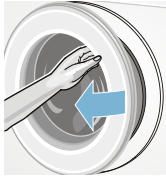

### Before switching on the appliance again:

#### Notes

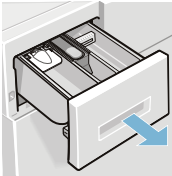
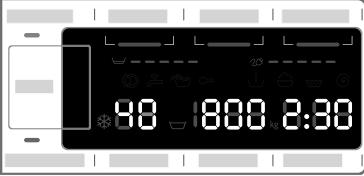
- The transport braces **must** be removed.
- Pour approx. 1 litre of water into compartment **II**, select the  **Drain** programme and start.  
This will prevent detergent from flowing unused into the drain during the next wash.

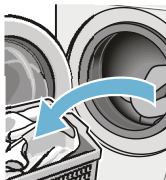
## Main points in brief

1				
	Connect the mains plug. Turn on the tap.	Open the door.	To switch on, press the <b>⏻</b> button.	Select a programme, e.g. <b>Cottons</b> .
2				
	Sort the laundry.	Observe the maximum load (depending on the model) on the display panel.	Load the laundry.	Close the door.
3				
	Add detergent.	If necessary, change the default programme settings and/or select additional settings.	Start the programme.	
4				
	End of the programme	Open the door and remove the laundry.	To switch off, press the <b>⏻</b> button.	Turn off the tap (for models without Aqua-Stop).





# Getting to know the appliance

## Washing machine

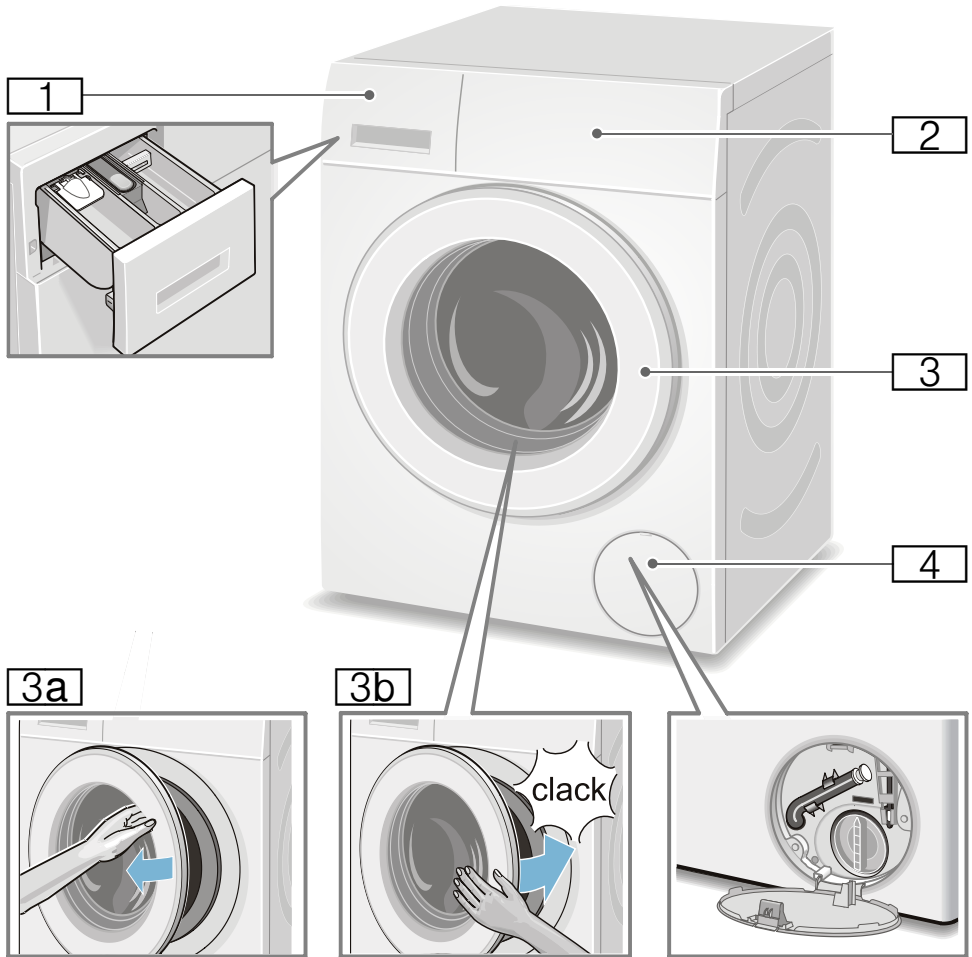

- 1** Detergent drawer → *Page 39*
- 2** Operating/display panel
- 3** Door with door handle
- 3a** Open the door
- 3b** Close the door
- 4** Service flap

## Control panel

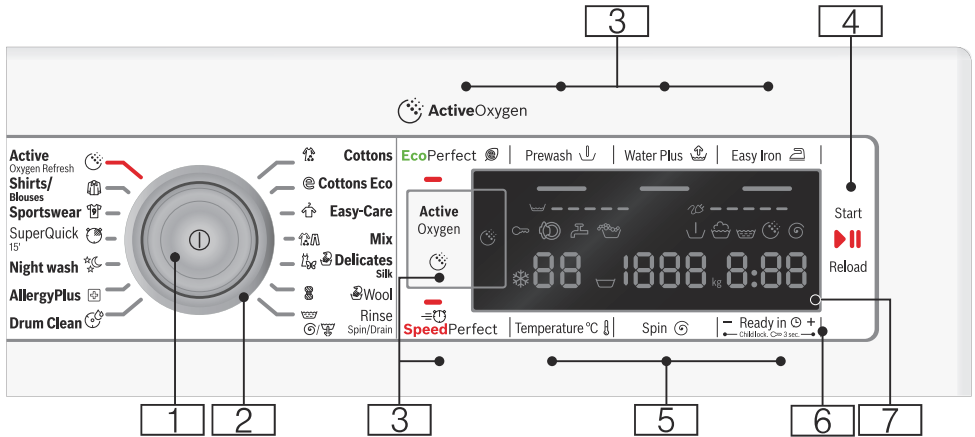

**Note:** All the buttons are sensitive (except for the main switch) and only need to be pressed lightly.

- 1 Main switch**  
for switching the washing machine on and off:  
Press the **⏻** button.
- 2 Programme selector**  
for selecting a programme.  
Programme overview → *Page 30*
- 3 Additional programme settings:**  
→ *Page 37*
  - SpeedPerfect **⚡**,
  - EcoPerfect **🌿**,
  - Prewash (**↓**),
  - Water Plus (**⬆️**),
  - Easy Iron (**👕**),
  - Active Oxygen **☁️**
- 4 **▶️** button for:**
  - Starting a programme,
  - Interrupting a programme, e.g. to add items of laundry  
→ *Page 41*,
  - Cancelling a programme  
→ *Page 41*

- 5 Changing the default programme settings:** → *Page 36*
  - Temperature °C (**ℓ**),
  - Spin speed (Spin **⊖**),
  - Ready in (**⌚**)
- 6 Child lock. ∞ 3 sec.**  
to prevent the set functions from being changed accidentally:  
To do so, press the **Ready in** (**⌚**) **+** and **-** buttons at the same time for approx. 3 seconds.  
→ *Page 40*
- 7 Display panel** for settings and information. → *Page 27*

## Display panel

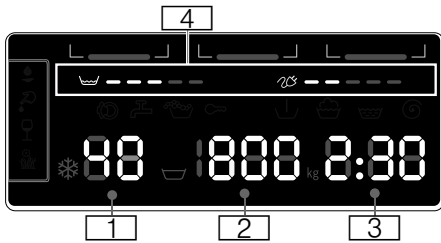

### Default programme settings:

- 1 **Temperature °C** in °C  
 \* - 90 (\* = cold)
- 2 **Spin speed** in rpm,  
 ▽, 0 - 1600\*;  
 \* Max. spin speed, depending on the selected programme and model,
  - 0 = no spin cycle, draining only → Page 36,
  - ▽ = Rinse Stop → Page 36
- 3 **Ready in**  
 e.g. 2:30;  
 Programme duration depends on the programme selection in h:min (hours:minutes)
  - **End time preselection**  
 1 - 24 h;  
 Programme ends after ... h (h = hours),
  - **Load recommendation**  
 e.g. kg 9\*;  
 \* depending on the selected programme
- 4 **Information on energy and water consumption:** → Page 13
  - = = = = =  
 Water consumption display,
  - = = = = =  
 Energy consumption display

### Further information

	Active Oxygen  → Page 37
<b>Programme progress:</b>	
	Active oxygen phase
	Prewash
	Wash
	Rinse
	Spin
- 0 -	Programme end
	Programme end during Rinse Stop
- P -	Pause, e.g. to reload laundry
<b>Loading door:</b>	
	The washing machine door can be opened.
	When the programme has started: The washing machine door is not closed properly.
<b>Tap:</b>	
	Tap not turned on, no water pressure
	Water pressure too low (may increase the programme duration)
<b>Childproof lock:</b> → Page 40	
	Childproof lock activated
	Childproof lock activated, programme selector adjusted
<b>Foam detection function:</b>	
	→ Page 40
	lights up
<b>Fault display:</b>	
E:--	→ Page 49
<b>Signal setting:</b>	
0 - 4	→ Page 43
<b>Automatic switch-off</b> of the appliance:	
On OFF	→ Page 13, → Page 43



## Laundry

### Prepare the laundry

#### Caution!

#### Damage to the appliance/fabrics

Foreign objects (e.g. coins, paperclips, needles, nails) may damage the laundry or components in the washing machine.

You should therefore note the following tips when preparing your laundry:

- Empty any pockets.

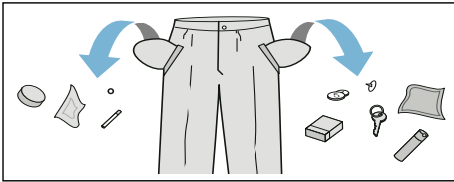

- Look out for metal items (paperclips, etc.) and remove them.
- Wash delicates in a laundry bag (tights, underwired bras, etc.).
- Close any zips; button up any cover buttons.
- Brush sand out of pockets and collars.
- Remove curtain fittings or place curtains in a laundry bag.

### Sorting laundry

Sort your laundry according to the care instructions and manufacturer's information on the care labels, depending on:







- Type of fabric/fibre
- Colour
  - Note:** Laundry may discolour. Wash white and coloured items separately. Wash new coloured items separately the first time you wash them.
- Soiling
  - Wash laundry with the same level of soiling together.

Some examples of soiling levels can be found on → Page 29

- **Light:** Do not prewash, select the **SpeedPerfect**  setting if necessary
- **Normal**
- **Heavy:** Load less laundry, select a programme with prewash
- **Stains:** Remove/pretreat stains while they are fresh. Firstly, dab with soapy water; do not rub. Then wash the items of laundry with the appropriate programme. Stubborn or dried-in stains can sometimes only be removed by washing several times.

- Symbols on the care labels

**Note:** The numbers in the symbols indicate the maximum washing temperature that may be used.

-  Suitable for normal washing process; e.g. Cottons programme
-  A gentle washing process is required; e.g. Easy-Care programme
-  An especially gentle washing process is required; e.g. Delicate/Silk programme
-  Suitable for washing by hand; e.g.  Woollens programme
-  Do not machine wash.

## Detergent

### Correct selection of detergent

The care label is crucial for selecting the correct detergent, temperature and treatment of the laundry. → See also [www.sartex.ch](http://www.sartex.ch)

If you visit [www.cleanright.eu](http://www.cleanright.eu), you will find further information on detergents, care products and cleaning agents for domestic use.

- **Standard detergent with optical brighteners**

Suitable for boil-washable white laundry made from linen or cotton  
Programme: Cottons/  
cold - max. 90 °C

- **Detergent for colours without bleach or optical brighteners**

Suitable for coloured laundry made from linen or cotton  
Programme: Cottons/  
cold - max. 60 °C

- **Detergent for colours/delicates without optical brighteners**

Suitable for coloured laundry made from easy-care fibres, synthetic fibres  
Programme: Easy-Care/  
cold - max. 60 °C

- **Detergent for delicates**

Suitable for delicate, fine fabrics, silk or viscose  
Programme: Delicate/Silk/  
cold - max. 40 °C

- **Detergent for woollens**

Suitable for wool  
Wool programme/  
cold - max. 40 °C

### Saving energy and detergent











For light and normal soiling, you can save energy (lower washing temperature) and detergent.































Saving	Soiling/note
Reduced temperature and detergent quantity as per the recommended dosage	<p><b>Light</b> No visible dirt or stains. Clothing has taken on some body odour, e.g.:</p> <ul style="list-style-type: none"> <li>■ Light summer/sports clothing (worn for a few hours)</li> <li>■ T-shirts, shirts, blouses (worn for up to one day)</li> <li>■ Guest bed linen and hand towels (used for one day)</li> </ul>
	<p><b>Normal</b> Visible dirt or a few light stains, e.g.:</p> <ul style="list-style-type: none"> <li>■ T-shirts, shirts, blouses (sweat soaked, worn a few times)</li> <li>■ Towels, bedding (used for up to one week)</li> </ul>
	<p><b>Heavy</b> Dirt and/or stains clearly visible, e.g. tea towels, baby items, work clothing</p>
Temperature as per the care label and detergent quantity as per the recommended dosage for heavy soiling	













**Note:** When measuring the amount of all detergents/additives/care products and cleaning agents, please always check the manufacturer's instructions and information. → Page 39

## Overview of programmes































### Programmes on the programme selector























Programme/type of laundry/information	Settings
<p><b>Programme name</b></p> <p>Brief explanation of the programme and the fabrics for which it is suitable.</p>	<p>Max. load</p> <p>Temperature °C that can be selected (☼ = cold)</p> <p>Spin speed that can be selected**; ☽ = Rinse Stop, 0 = no spin cycle, draining only</p> <p>Additional programme settings that can be selected</p>
<p> <b>Cottons</b></p> <p>Hard-wearing items, heat-resistant items made of cotton or linen</p> <p><b>Note:</b> . The <b>SpeedPerfect</b>  setting is suitable as a short programme for lightly soiled laundry.</p>	<p>Max. 9 kg/5* kg</p> <p>☼ - 90 °C</p> <p>☽, 0 - 1600** rpm</p> <p>EcoPerfect , SpeedPerfect ,</p> <p>Prewash (☽),</p> <p>Water Plus (☼),</p> <p>Easy Iron (☽),</p> <p>Active Oxygen  ****</p>
<p> <b>Cottons Eco</b> </p> <p>Hard-wearing items, heat-resistant items made of cotton or linen; energy-optimised washing that works by reducing the temperature while achieving a comparable washing result to the  <b>Cottons</b> programme.</p> <p><b>Note:</b> . The washing temperature is lower than the selected temperature. If you want to achieve a higher water temperature, use the  <b>Cottons</b> programme with a higher temperature as required.</p>	<p>Max. 9 kg</p> <p>☼ - 90 °C</p> <p>☽, 0 - 1600** rpm</p> <p>Prewash (☽),</p> <p>Water Plus (☼),</p> <p>Easy Iron (☽),</p> <p>Active Oxygen  ****</p>
<p>* Reduced load for the <b>SpeedPerfect</b>  setting</p> <p>** Max. spin speed depends on the model</p> <p>*** Programme depends on the model</p> <p>**** Can be selected for washing temperatures up to 40 °C</p>	

Programme/type of laundry/information	Settings
<p> <b>Easy-Care</b> Items made of synthetic or blended fabrics</p>	<p>Max. 4 kg   ... 60 °C   0 - 1200 rpm                      EcoPerfect , SpeedPerfect ,                      Prewash () ,                      Water Plus () ,                      Easy Iron () ,                      Active Oxygen  ****</p>
<p> <b>Mix</b> Mixed load of cottons and synthetic fabrics</p>	<p>Max. 4 kg   - 40 °C   0 - 1600** rpm                      EcoPerfect , SpeedPerfect ,                      Prewash () ,                      Water Plus () ,                      Easy Iron () ,                      Active Oxygen </p>
<p> <b>Delicates / Silk</b> For delicate, washable items, e.g. made of silk, satin, synthetic or blended fabrics (e.g. silk blouses, silk scarves)  <b>Note:</b> . Use a detergent that is suitable for machine-washing delicate fabrics or silk.</p>	<p>Max. 2 kg   - 40 °C   0 - 800 rpm                      EcoPerfect , SpeedPerfect ,                      Prewash () ,                      Water Plus () ,                      Easy Iron ()</p>
<p> <b>Wool</b> Hand- or machine-washable items that are made of wool or contain wool; particularly gentle wash programme to prevent laundry from shrinking, with longer pauses in the programme (during which the items rest in the water)  <b>Notes</b></p> <ul style="list-style-type: none"> <li>■ Wool is of animal origin, e.g. angora, alpaca, llama, sheep.</li> <li>■ Use a detergent that is suitable for machine-washing wool.</li> </ul>	<p>Max. 2 kg   - 40 °C   0 - 800 rpm                      -</p>
<p>* Reduced load for the <b>SpeedPerfect</b>  setting                      ** Max. spin speed depends on the model                      *** Programme depends on the model                      **** Can be selected for washing temperatures up to 40 °C</p>	

Programme/type of laundry/information	Settings
<b>Rinse</b>  / <b>Spin</b>  / <b>Drain</b>  Combined extra programme for rinsing and spinning the laundry, and draining the rinsing water <b>Note:</b> . The <b>Water Plus</b> (  ) button is activated at the factory for this programme. <b>If you only want to spin the laundry:</b> Deactivate the <b>Water Plus</b> (  ) button and, if required, adjust the spin speed. <b>If you only want to drain the water:</b> Deactivate the <b>Water Plus</b> (  ) button and select the spin speed <b>0</b> .	- - ☹, 0 - 1600** rpm Water Plus (  ), Easy Iron (  )
<b>ActiveOxygen Refresh</b>  Mixed load of cottons, synthetic fabrics, silk, satin and wool; programme for removing odours, e.g. the smell of cigarettes and kitchen odours → <i>Page 35</i>	Max. 1 kg - - -
<b>Notes</b> <ul style="list-style-type: none"> <li>■ Do not exceed the maximum load.</li> <li>■ Not a wash programme/not suitable for removing stains or sweat.</li> <li>■ Load dry laundry only.</li> <li>■ Before loading the laundry, wipe the drum dry if necessary, turning it as you do so to remove all water.</li> </ul>	
 <b>Drum Clean</b> Programme for cleaning and caring for the drum and the outer tub Run the programme, e.g.: <ul style="list-style-type: none"> <li>■ Before using the appliance for the first time,</li> <li>■ If you regularly wash at low temperatures (40 °C or lower) or</li> <li>■ If you have been away for an extended period and odours have built up.</li> </ul>	0 kg 80, 90 °C 1200 rpm Active Oxygen 
<b>Notes</b> <ul style="list-style-type: none"> <li>■ The  <b>Drum Clean</b> indicator light will flash if you have not used a programme at 60 °C or higher for a long time.</li> <li>■ Run the programme without laundry.</li> <li>■ Use standard washing powder or a detergent containing bleach. To prevent foaming, only use half the amount of detergent recommended by the detergent manufacturer. Do not use detergents intended for woollens or delicates.</li> </ul>	
* Reduced load for the <b>SpeedPerfect</b>  setting ** Max. spin speed depends on the model *** Programme depends on the model **** Can be selected for washing temperatures up to 40 °C	



Programme/type of laundry/information	Settings
<p> <b>SuperQuick 15'</b> Extra-short programme of approx. 15 minutes, suitable for small items of lightly soiled laundry</p>	<p>Max. 2 kg   - 40 °C   0 - 1200 rpm                      -</p>
<p><b>*** Dark wash</b> Dark-coloured cottons and dark-coloured easy-care items; turn items inside-out before washing.</p>	<p>Max. 3.5 kg   - 40 °C   0 - 1200 rpm                      EcoPerfect , SpeedPerfect                       Prewash ()                      Water Plus ()                      Easy Iron ()                      Active Oxygen </p>
<p> <b>AllergyPlus</b> Hard-wearing items made of cotton or linen <b>Note:</b> . Particularly suitable for strict hygiene requirements or particularly sensitive skin thanks to the extended wash cycle at a defined temperature, higher water level and extended rinse cycle.</p>	<p>Max. 6.5 kg   - 60 °C   0 - 1600** rpm                      EcoPerfect , SpeedPerfect                       Prewash ()                      Water Plus ()                      Easy Iron ()                      Active Oxygen  ****</p>
<p> <b>Sportswear</b> Sportswear and leisurewear made from microfibre fabrics <b>Notes</b></p> <ul style="list-style-type: none"> <li>■ Laundry must not be treated with fabric softener.</li> <li>■ Before washing, clean the detergent drawer thoroughly (all compartments) to remove any fabric-softener residue.</li> </ul>	<p>Max. 2 kg   - 40 °C   0 - 800 rpm                      EcoPerfect , SpeedPerfect                       Prewash ()                      Water Plus ()                      Easy Iron ()                      Active Oxygen </p>
<p>* Reduced load for the <b>SpeedPerfect</b>  setting                      ** Max. spin speed depends on the model                      *** Programme depends on the model                      **** Can be selected for washing temperatures up to 40 °C</p>	

Programme/type of laundry/information	Settings
<p>***  <b>Night wash</b></p> <p>Particularly quiet programme for washing overnight; suitable for items made from cotton, linen, synthetic or blended fabrics</p> <p><b>Notes</b></p> <ul style="list-style-type: none"> <li>■ End signal deactivated,</li> <li>■ Reduced final spin speed set by default and shorter washing time</li> </ul>	<p>Max. 4 kg</p> <p> - 40 °C</p> <p> 0 - 1200 rpm</p> <p>EcoPerfect , SpeedPerfect ,</p> <p>Prewash () ,</p> <p>Water Plus () ,</p> <p>Easy Iron () ,</p> <p>Active Oxygen </p>
<p> <b>Shirts / Blouses</b></p> <p>Non-iron shirts or blouses made of cotton, linen, synthetic or blended fabrics</p> <p><b>Notes</b></p> <ul style="list-style-type: none"> <li>■ Shirts/blouses are only given a short spin on the <b>Easy Iron</b> () setting. Hang them up to dry while still dripping wet. → Self-smoothing effect</li> <li>■ Use the   <b>Delicates / Silk</b> programme to wash shirts/blouses made of silk or delicate fabrics.</li> </ul>	<p>Max. 2 kg</p> <p> - 60 °C</p> <p> 0 - 800 rpm</p> <p>EcoPerfect , SpeedPerfect ,</p> <p>Prewash () ,</p> <p>Water Plus () ,</p> <p>Easy Iron () ,</p> <p>Active Oxygen  ****</p>
<p>* Reduced load for the <b>SpeedPerfect</b>  setting</p> <p>** Max. spin speed depends on the model</p> <p>*** Programme depends on the model</p> <p>**** Can be selected for washing temperatures up to 40 °C</p>	

## ActiveOxygen Refresh

**ActiveOxygen Refresh**  is an innovative programme that is designed to refresh laundry and remove odours (e.g. the smell of cigarettes and kitchen odours). Sweaty fabrics must be washed.

In this programme, your laundry is treated with active oxygen and water mist; detergent is not added.



Active oxygen is a special type of oxygen which effectively reduces odours.

The programme is suitable for all types of material and fabric, even for those which should only be professionally cleaned.

Once the programme has started, the drum inside the appliance lights up and the mist that is created can be seen.

Once the programme has finished, take the laundry out of the drum and shake it out briefly.

### Notes

- Leave the door and detergent drawer open slightly when the appliance is not in use. → *Page 45*
- The active oxygen treatment is less effective if the drum is dirty. Run the  **Drum Clean** programme regularly.
- It is not possible to add laundry once the programme has started.
- If you cancel the programme or switch to a different one, the door will remain locked until there is no longer any active oxygen in the drum. This may take up to 25 minutes. The two symbols  and  will flash during this time. The door will then unlock automatically.

## Starching

**Note:** Laundry should not be treated with fabric softener.





Liquid starch can be used to stiffen fabrics particularly in the Rinse and Cottons programmes. Measure starch into compartment  in accordance with the manufacturer's instructions (clean first if necessary).

## Dyeing/bleaching

Dye should only be used in normal household quantities. Salt may damage stainless steel. Always follow the dye manufacturer's instructions.

Do **not** use the washing machine to bleach clothes.

## Soaking

1. Switch on the appliance.
2. Select the  **Cottons 30 °C** programme.
3. Pour soaking agent/detergent into compartment **II** in accordance with the manufacturer's instructions.
4. Press the  button. The programme starts.
5. After approx. 10 minutes, press the  button to pause the programme.
6. Leave the laundry to soak for as long as required, then either press the  button again to continue the programme or change the programme.

### Notes

- Load laundry of the same colour.
- No additional detergent is required; the soaking solution is used for washing.

## **P+** Programme default settings

The default programme settings are displayed in the display panel after selecting the programme.

You can change the default settings.

An overview of all programme settings, which can be selected depending on the programme, can be found from → Page 30.

### Temperature °C

()

Depending on what stage the programme is in, you can change the set temperature before and during the programme.

The maximum temperature that can be set depends on the programme that has been selected.

### Spin speed

(Spin )

Depending on what stage the programme is in, you can change the spin speed (in rpm; revolutions per minute) before and during the programme.

**Setting 0:** The rinsing water is drained but there is no final spin. The laundry stays wet inside the drum, e.g. for items that should not be spun.

**Setting **: Rinse Stop = no final spin. The laundry stays in the water after the final rinse.

You can select "Rinse Stop" to prevent creasing if the laundry will not be taken out of the washing machine immediately after the programme has ended.

To continue/end the programme  
→ Page 41

The maximum speed that can be set depends on the model and programme that has been selected.

### Ready in

()

**Before starting the programme**, you can preselect the programme end ("Ready in" time) in hourly increments (h = hour) up to a maximum of 24 hours.

To do this:

1. Select a programme.  
The programme duration is displayed for the selected programme, e.g. **2:30** (hours:minutes).
2. Press the **Ready in** button repeatedly until the required number of hours is displayed.  
**Note:** The setting values are increased using the **Ready in +** button, and decreased using the **Ready in -** button.
3. Press the  button.  
The programme starts.  
The selected number of hours (e.g. **8 h**) is shown in the display panel and counts down until the wash programme starts. The duration of the programme is then displayed.

**Note:** The length of the programme is automatically adjusted when the programme is running. Changes to the default programme settings or programme settings may also change the programme duration.

### After starting the programme

(if a Ready in time has been selected and the wash programme has not yet started), you can change the preselected number of hours as follows:

1. Press the  button.
2. Use the **Ready in -** or **+** button to change the number of hours.
3. Press the  button.

**After starting the programme**, you can add or remove laundry if necessary.  
→ Page 41

## **P+** Additional programme settings

An overview of all additional settings, which can be selected depending on the programme, can be found from → *Page 30*.

### **SpeedPerfect**

Washing in a shorter time while achieving a washing result that is consistent with, but uses more energy than, the selected programme, without the SpeedPerfect  setting.

**Note:** Do not exceed the maximum load.

Overview of programmes → *Page 30*

### **EcoPerfect**

Energy-optimised washing by reducing the temperature while achieving a washing result that is consistent with the selected programme, without the EcoPerfect  setting.

### **Prewash**

(↓)

For heavily soiled laundry.

**Note:** Pour detergent into compartments **I** and **II**.

### **Water Plus**

(↑)

Higher water level and additional rinse cycle for particularly sensitive skin and/or for areas with very soft water.

## **Easy Iron**

()

Reduces creasing thanks to a special spin sequence followed by fluffing and reduced spin speed.

**Note:** The washing's residual moisture is increased.

## **Active Oxygen**

The laundry is additionally treated with active oxygen before the wash cycle and before the final rinse cycle in order to thoroughly remove germs and bacteria.



## Operating the appliance

### Preparing the washing machine

**Note:** The washing machine **must be correctly installed** and **connected**.  
From → Page 14.

1. Connect the mains plug.
2. Turn on the tap.
3. Open the door.
4. Check that the drum is completely drained. Drain if necessary.

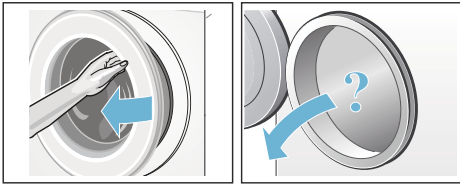

### Switching on the appliance/ selecting a programme

Press the **Ⓢ** button. The appliance is switched on.

The **👤 Cottons** programme set at the factory is then always displayed.

You can use this programme or select a different programme. The programme selector can be turned in either direction.

**Note:** If you have activated the childproof lock, you must deactivate it before you can set a different programme. → Page 40

The indicator light on the programme selector lights up and the **default programme settings** for the selected programme appear in the display panel:

- Temperature
- Spin speed

- The maximum load and the duration of the programme (alternately)
- Information on water and energy consumption

In appliances with a **drum light**:

The drum is lit after switching on the appliance, after opening and closing the door and after starting the programme. The light switches off automatically.

### Placing laundry into the drum



#### Warning

#### Danger of death!

Items of laundry pretreated with cleaning agents that contain solvents, e.g. stain remover/cleaning solvent, may cause an explosion after being loaded into the washing machine.

Hand-rinse these items of laundry thoroughly beforehand.

#### Notes

- Mix items of laundry of varying sizes. Laundry items of different sizes distribute themselves better during the spin cycle. Individual laundry items may cause an unbalanced load.
- Observe the maximum specified load. Overfilling adversely affects the washing result and promotes creasing.

1. Unfold presorted laundry items and place them in the drum.
2. Make sure that no items of laundry are trapped between the door and the rubber seal, and close the door.

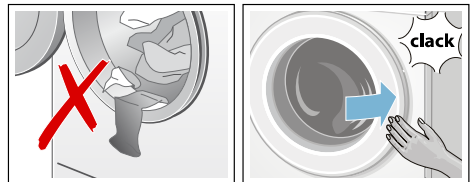

The **▷|** button indicator lamp flashes and the programme settings appear in the display panel.

## Measure and add detergent and care products

### Caution!

#### Damage to the appliance

Cleaning agents and agents for pre-treating laundry (e.g. stain removers, prewash sprays, etc.) may cause damage if they come into contact with the surfaces of the washing machine. Do not allow these agents to come into contact with the surfaces of the washing machine. If necessary, immediately wipe away spray residue and other residues/droplets with a damp cloth.

### Dosing

Dose the detergents and care products according to:

- Water hardness (ask your water supply company)
- The manufacturer's instructions on the packaging
- The amount of laundry
- Soiling → *Page 29*

### Filling

#### **Warning** **Eye/skin irritation!**

Detergents and care products may spray out if the detergent drawer is opened while the machine is in operation. Open the drawer carefully. Rinse eyes/skin thoroughly if they come into contact with detergents or care products. If accidentally swallowed, seek medical advice.

**Note:** Dilute viscous fabric softener and fabric conditioner with a little water. This prevents blockages in the washing machine's piping.

Pour the detergent and care products into the appropriate compartments:

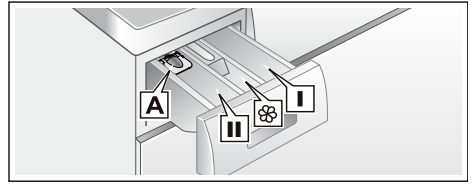

- Measuring aid **A** For liquid detergent  
 Compartment **II** Detergent for the main wash, water softener, bleach, stain remover  
 Compartment  Fabric softener, liquid starch; do not exceed **max.**  
 Compartment **I** Detergent for prewash

1. Pull out the detergent drawer as far as possible.
2. Add detergent and/or care products.
3. Close the detergent drawer.

#### Measuring aid\* for liquid detergent

\*depending on the model

Position the measuring aid for dosing the correct amount of liquid detergent:

1. Pull out the detergent drawer. Press down the insert and fully remove the drawer.
2. Slide the measuring aid forwards, fold it down and click it into place.
3. Reinsert the drawer.

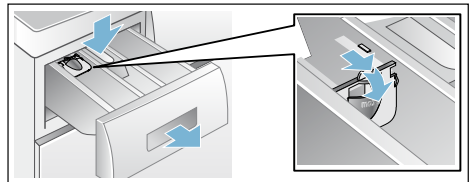

**Note:** Do not use the measuring aid for gel detergents and washing powder, or for programmes with prewash or when the "Ready in" time is selected.

**For models without a measuring aid,** pour the liquid detergent into the appropriate dispenser and place it in the drum.

## Change the programme default settings

You can use or change the default settings for this washing cycle.

To do this, repeatedly press the corresponding button until the required setting is displayed.

**Note:** Pressing and holding the button automatically runs through the set values to the end. Then press the button once more and you can then change the setting values again.

The settings are activated without needing to be confirmed.

The settings are not saved after switching off the washing machine.

Default programme settings → *Page 36*

## Select additional programme settings

By selecting additional settings, you can better adapt the washing process to your items of laundry.

The settings can be selected or deselected depending on the programme progress.

The button indicator lamps light up if a setting is activated.

The settings are not saved after switching off the washing machine.

Additional programme settings → *Page 37*

## Start the programme

Press the  button. The indicator lamp lights up and the programme starts.

The display panel shows the "Ready in" time while the programme is running or the programme length and the programme progress symbols when the washing programme has started.

Display panel → *Page 27*

### **Note: Foam detection**

If the  symbol also lights up in the display panel, the washing machine has detected too much foam during the wash programme and automatically activated additional rinse cycles to remove the foam.



Add less detergent to the next washing cycle with the same load.

If you want to lock the programme to prevent it from being inadvertently adjusted, you can select the childproof lock as follows.

### **Child lock.** **3 sec.**

You can lock the washing machine to prevent the functions you have set from being changed inadvertently. To do this, activate the childproof lock.

To **activate/deactivate**, press and hold the **Ready in -** and **+** buttons at the same time for approx. three seconds. The  symbol is appears in the display panel.

-  lights up: The childproof lock is active.
-  flashes briefly: The childproof lock is active and the programme selector was turned or a button was pressed.

**Note:** The childproof lock remains active, even once the washing machine has been switched off. Before selecting the next programme, deactivate the childproof lock.



## Adding laundry

After starting the programme, you can add or remove laundry if necessary.

Press the  button to do this.



The  button indicator light will flash and the machine will check whether it is possible to add laundry.

If

- **Both** the - P - and  symbols light up on the display panel, it is possible to add laundry.
- - P - lights up, it is not possible to add laundry.

**To resume the programme, press the  button.** The programme will resume automatically.

### Notes



- Do not leave the door open for too long when adding laundry as water from the laundry may leak out.
- For safety reasons, the door remains locked when the water level or temperature is high, while the drum is turning or during the active oxygen phases, and it is not possible to add laundry during this time.
- It is not possible to add laundry during the ActiveOxygen Refresh  programme or when the Active Oxygen  setting has been selected.
- The load indicator is not active during reloading.

## Changing the programme

If you have started the wrong programme by mistake, you can change the programme as follows:



1. Press the  button.
2. Select another programme.
3. Press the  button. The new programme starts from the beginning.

**Note:** When switching from programmes that use active oxygen to those that do not, the door will remain locked for up to 25 minutes until there is no longer any active oxygen in the drum.





The  and  symbols will flash. If the symbols are off, the door can be opened.

## Cancel the programme



For programmes at high temperatures:

1. Press the  button.
2. To cool down laundry: Select  **Rinse**.
3. Press the  button.

For programmes at low temperatures:

1. Press the  button.
2. Select  **Spin** or  **Drain**.
3. Press the  button.



**Note:** When cancelling programmes that use active oxygen, the door will remain locked for up to 25 minutes until there is no longer any active oxygen in the drum.

Switch the appliance on again if necessary. The  and  symbols will flash. If the symbols are off, the door can be opened.



## Programme end during rinse hold

In the display panel,  flashes, and the preset spin speed and remaining programme length are displayed for the selected programme.

Continue the programme by:

- Pressing the  button or
- Changing the spin speed, or setting the programme selector to  **Drain** and then pressing the  button.

## Programme end

- 0 - and  appear in the display panel.  
The  button indicator lamp is off.

## Removing laundry/switching off the appliance

1. Open the door and remove the laundry.
2. Press the  button. The appliance is switched off.
3. Turn off the tap.

**Note:** Not required for Aqua-Stop models.

### Notes

- Do not leave any items of laundry in the drum. They may shrink in the next wash or discolour another item.
- Remove any foreign objects from the drum and the rubber seal – risk of rusting.
- Wipe the rubber seal dry.

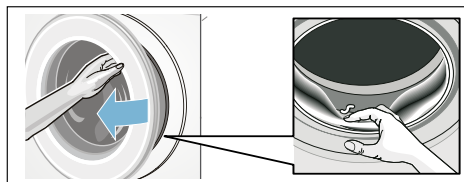

- Leave the door and detergent drawer open so that any residual water can evaporate. → *Page 45*
- Always wait until the programme ends, as the appliance could still be locked. Then switch the appliance on and wait for it to unlock.
- If the display panel goes off at the end of a programme, the energy-saving mode is active. Press any button to activate the panel.

## Appliance settings

You can change the following settings:

- The volume of the buttons and the information signals (e.g. at the end of the programme)
- Select/deselect the appliance's automatic switch-off function → *Page 13*
- Switch the drum-care information signal on/off (depending on the model). From → *Page 30* onwards

You will need to activate the setting mode in order to change these settings.

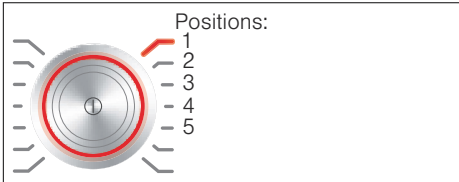

### Activating the setting mode

1. Press the **ⓘ** button.  
The appliance is switched on and the **Cottons** programme is shown at position 1.
2. Press the **Temperature °C** button and, at the same time, turn the programme selector clockwise to position 2. Release the button.  
The setting mode is activated and the preset volume for the information signals appears in the display panel.

You can now change the settings:

### Changing the signal volume

Use the **Ready in +** or **-** button to change the following settings at the corresponding programme selector positions:

- 2: The volume of the information signals and/or
- 3: The volume of the button signals.



0 = off,  
1 = quiet,  
2 = medium,  
3 = loud,  
4 = very loud

Exit setting mode or:

### Selecting/deselecting the appliance automatic switch-off

With the programme selector in position 4, press the **Ready in +** or **-** button to turn the automatic switch-off function on or off.

Exit setting mode or:

### Switching the drum-care information signal on/off

depending on the model

With the programme selector in position 5, press the **Ready in +** or **-** button to switch the **Drum Clean** information signal on or off.

### Exiting setting mode

To exit and save the settings, press the **ⓘ** button.

The appliance is switched off. The selected settings will take effect the next time the washing machine is switched on.



## Sensors

---

### Automatic load sensing

Depending on the type of fabric and load, the automatic load sensing function optimally adjusts the water consumption and programme duration in each programme.

### Unbalanced load detection system

The automatic unbalanced load detection system detects imbalances and ensures even distribution of the laundry by repeatedly starting and stopping drum spinning.

If the laundry is extremely unevenly distributed, the speed is reduced or the spin cycle is not performed for safety reasons.

**Note:** Place large and small items of laundry evenly in the drum.

→ Page 38, → Page 50

### AquaSensor

depending on the model

During the rinse cycle, the AquaSensor checks the degree of turbidity (turbidity is caused by dirt and detergent residue) of the rinsing water. The duration and the number of rinse cycles depend on the turbidity of the water.



## Cleaning and maintenance

### **Warning**

#### **Danger of death!**

There is a risk of electric shock if you touch live components. Switch off the appliance and pull out the mains plug.

### **Warning**

#### **Risk of poisoning!**

Toxic vapours can be produced by cleaning agents that contain solvents, e.g. cleaning solvent. Do not use cleaning agents that contain solvents.

### **Caution!**

#### **Damage to the appliance**

Cleaning agents that contain solvents, e.g. cleaning solvent, can damage surfaces and components in the machine. Do not use cleaning agents that contain solvents.

#### **Prevent detergent residue from building up and odours from forming by following these instructions:**

### **Notes**

- Ensure the room in which the washing machine is set up is well ventilated.
- Leave the door and detergent dispenser tray open slightly when the washing machine is not in use.
- Occasionally run a wash using the  **Cottons 60 °C** programme and powder detergent.

## Machine housing/control panel

- Wipe the housing and the control panel with a soft, damp cloth.
- Remove the detergent residue immediately.
- Do not clean with a water jet.

## Drum

Use chlorine-free cleaning agents, do not use steel wool.

If there are odours in the washing machine, or to clean the drum, run the  **Drum Clean 90 °C** programme without laundry. Add washing powder.

## Descaling

Descaling should not be necessary if the detergent is measured out correctly. However, if it is required, follow the manufacturer's instructions for the descaling agent. Suitable descalers can be obtained via our website or from customer services. → *Page 52*

## Detergent drawer and housing

If the washing machine contains detergent or fabric softener residues:

1. Pull out the detergent drawer. Press down the insert and fully remove the drawer.
2. To remove the insert: Push the insert upwards from below with your finger.

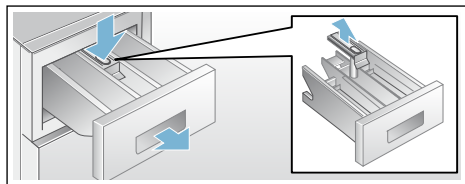

3. Clean the detergent dispenser tray and insert with water and a brush, and dry it. Clean the inside of the housing as well.
4. Fit the insert and lock it in place (push the cylinder onto the guide pin).
5. Push in the detergent drawer.

**Note:** Leave the detergent drawer open so that any residual water can evaporate.

## The drain pump is blocked, emergency draining

### **Warning** **Risk of scalding!**

When you wash at high temperatures, the water gets very hot. If you come into contact with the hot water, you may be scalded.

Allow the water to cool down.

1. Turn off the tap so that no more water can flow in and has to be drained via the drain pump.
2. Switch off the appliance. Pull out the mains plug.
3. Open and remove the service flap.

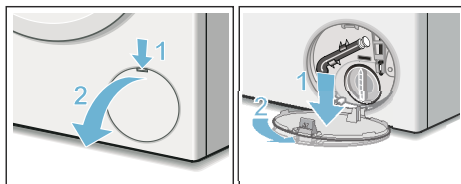

4. Take the drain hose out of the retainer. Remove the sealing cap and pour the water out into a suitable container. Replace the sealing cap and place the drain hose back in the retainer.

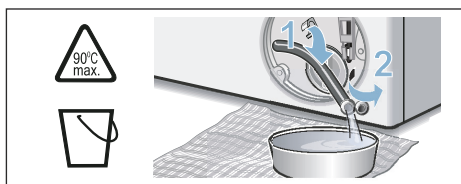

5. Carefully unscrew the pump cover; residual water may leak out. Clean the interior, pump-cover thread and pump housing. The impeller in the drain pump must be able to rotate. Refit the pump cover and screw it on tightly. The handle must be in a vertical position.

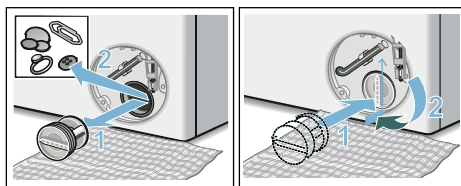

6. Place the service flap back on, lock it into place, and close it.

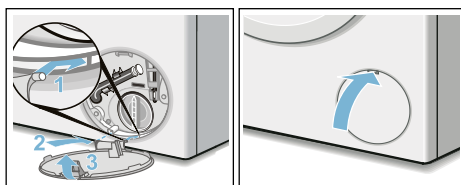

**Note:** To prevent unused detergent from flowing straight into the drain during the next wash: Pour 1 litre of water into compartment **II** and start the  **Drain** programme.

## The drain hose at the siphon is blocked

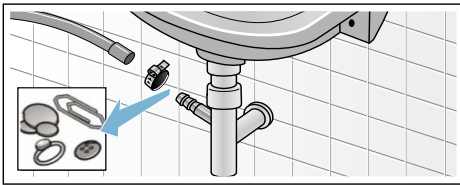

1. Switch off the appliance. Pull out the mains plug.
2. Loosen the hose clamp. Carefully remove the drain hose; residual water may leak out.
3. Clean the drain hose and siphon connecting piece.



4. Re-attach the drain hose and secure the connection point using the hose clamp.

## Filter in the water supply blocked

**First, reduce the water pressure in the supply hose:**

1. Turn off the tap.
2. Select any programme (except Rinse/Spin/Empty).
3. Press the  button. Allow the programme to run for approximately 40 seconds.
4. Press the  button. The appliance is switched off.
5. Pull out the mains plug.

**Then clean the filter:**

1. Disconnect the hose from the tap. Clean the filter with a small brush.

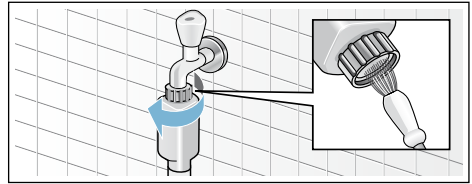

2. For standard and Aqua-Secure models, clean the filter on the rear of the appliance: Remove the hose from the rear of the appliance. Use pliers to remove the filter and then clean it.

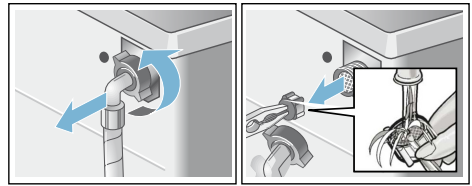

3. Connect the hose and check for leaks.

## ? Faults and what to do about them.

### Emergency release

E.g. in the event of a power cut

The programme continues when the power supply is restored.

However, if the laundry has to be removed, the washing machine door can be opened as follows:

#### **Warning** **Risk of scalding!**

When you are washing at high temperatures, there is a risk of scalding if you come into contact with hot detergent solution and laundry. If possible, leave it to cool down first.

#### **Warning** **Risk of injury!**

Reaching into the drum while it is still turning may cause hand injuries. Do not reach into the drum when it is turning. Wait until the drum has stopped turning.

#### **Warning** **Irritation of the respiratory tract!**

Any active oxygen that is emitted may irritate the mucosa and cause eyes to water.

Do not open the door using the emergency release if a programme is running with active oxygen. Wait until there is no active oxygen in the drum.

#### **Caution!** **Water damage**

Any escaping water may cause water damage.





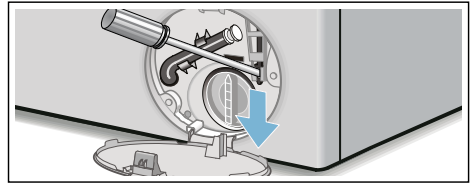





Do not open the washing machine door if water can be seen through the glass.

1. Switch off the appliance. Pull out the mains plug.
2. Drain the water. → *Page 46*
3. Use a tool to pull the emergency release downwards and then release.  
The washing machine door can then be opened.























## Information on the display panel

Indicator/symbol	Cause/remedy
- P - and 	The door is unlocked. It is possible to add laundry.
- P -	<ul style="list-style-type: none"> <li>■ The temperature is too high. Wait until the temperature drops.</li> <li>■ The water level is too high. It is not possible to add laundry. Close the door immediately, if necessary. Press the  button to resume the programme.</li> </ul>
 is flashing	<ul style="list-style-type: none"> <li>■ Laundry may be trapped. Open and close the door again and press the  button.</li> <li>■ If necessary, push the door closed or remove the laundry and then push the door closed again.</li> <li>■ If necessary, switch the appliance off and on again; set the programme and select the individual settings you require; start the programme.</li> </ul>
 and the ActiveOxygen Refresh  indicator light are flashing	The door cannot be opened due to the programme. If the lights are off, the door can be opened.
 is lit	<ul style="list-style-type: none"> <li>■ Turn the tap on fully,</li> <li>■ Supply hose kinked/trapped,</li> <li>■ The water pressure is too low. Clean the filter. → <i>Page 47</i></li> </ul>
	The childproof lock is activated – deactivate it. → <i>Page 40</i>
 is lit	Too much foam has been detected and additional wash cycles have been activated. Add less detergent to the next wash cycle with the same load.
The indicator light for the  Drum Clean programme is flashing	<p>Run the  <b>Drum Clean 90 °C</b> programme or a 60 °C programme with standard washing powder to clean and care for the drum and the outer tub.</p> <p><b>Notes</b></p> <ul style="list-style-type: none"> <li>■ Run the programme without laundry.</li> <li>■ Use standard washing powder or a detergent containing bleach. To prevent foaming, only use half the amount of detergent recommended by the detergent manufacturer. Do not use detergents intended for woollens or delicates.</li> <li>■ Switch the information signal on/off. → <i>Page 43</i></li> </ul>
E:18	<ul style="list-style-type: none"> <li>■ The drain pump is blocked. Clean the drain pump. → <i>Page 46</i></li> <li>■ The drain hose/drain pipe is blocked. Clean the drain hose at the siphon. → <i>Page 47</i></li> </ul>
E:23	There is water in the base trough; the appliance is leaking. Turn off the tap. Call the after-sales service. → <i>Page 52</i>
Other indicators/symbols	Switch off the appliance, wait for five seconds and then switch it on again. If the indicator/symbol appears again, call the after-sales service. → <i>Page 52</i>

## Faults and what to do about them.

Faults	Cause/remedy
Water is leaking from the machine.	<ul style="list-style-type: none"> <li>■ Attach the drain hose correctly or replace it.</li> <li>■ Tighten the threaded joint on the supply hose.</li> </ul>
The appliance is not filling with water.	<ul style="list-style-type: none"> <li>■ Have you pressed the  button?</li> <li>■ Is the tap turned on?</li> </ul>
Detergent is not being dispensed.	<ul style="list-style-type: none"> <li>■ Could the filter be clogged? Clean the filter. → <i>Page 47</i></li> <li>■ Is the supply hose kinked or trapped?</li> </ul>
The door will not open.	<ul style="list-style-type: none"> <li>■ The safety function is activated. Have you stopped the programme? → <i>Page 41</i></li> <li>■ Is the  childproof lock activated? Deactivate it. → <i>Page 40</i></li> <li>■ Is  selected (Rinse Stop = no final spin)? → <i>Page 41</i></li> <li>■ Can the door only be opened by the emergency release? → <i>Page 48</i></li> <li>■ When switching from a programme that uses active oxygen to one that does not, the door will remain locked for up to 25 minutes until there is no longer any active oxygen in the drum.</li> </ul>
The programme will not start.	<ul style="list-style-type: none"> <li>■ Have you pressed the  or <b>Ready in</b> button?</li> <li>■ Is the door closed?</li> <li>■ Is the  childproof lock activated? Deactivate it. → <i>Page 40</i></li> </ul>
The drum briefly jerks or judders after the programme has started.	Not a fault – the internal motor test may cause the drum to jerk or judder briefly when the wash programme starts.
The water is not draining.	<ul style="list-style-type: none"> <li>■ Is  selected (Rinse Stop = no final spin)? → <i>Page 41</i></li> <li>■ Clean the drain pump. → <i>Page 46</i></li> <li>■ Clean the drain pipe and/or the drain hose.</li> </ul>
Water is not visible in the drum.	Not a fault – the water is below the visible area.
The spin result is not satisfactory. Laundry wet/too damp.	<ul style="list-style-type: none"> <li>■ Not a fault – the unbalanced load detection system has interrupted the spin cycle because the laundry is unevenly distributed. Distribute small and large items of laundry evenly in the drum.</li> <li>■ Is <b>Easy Iron</b> selected (depending on the model)? → <i>Page 37</i></li> <li>■ Is the selected speed too low?</li> </ul>
The appliance restarts the spin cycle several times.	Not a fault – the unbalanced load detection system is adjusting an imbalance.
The programme is taking longer than usual.	<ul style="list-style-type: none"> <li>■ Not a fault – the unbalanced load detection system is adjusting an imbalance by repeatedly redistributing the laundry.</li> <li>■ Not a fault – the foam detection system is on – a rinse cycle has been activated.</li> </ul>
The length of the programme changes during the wash cycle.	Not a fault – the programme sequence is optimised for the specific washing process. This may change the length of the programme shown on the display panel.

Faults	Cause/remedy
Water remaining in the care product compartment  .	<ul style="list-style-type: none"> <li>■ Not a fault – the effectiveness of the care product is not affected.</li> <li>■ Clean the insert if necessary.</li> </ul>
Odours in the washing machine.	<p>Run the  <b>Drum Clean</b> or  <b>Cottons 90 °C</b> programme without laundry. Add standard washing powder or a detergent that contains bleach.</p> <p><b>Note:</b> . To prevent foaming, only use half the amount of detergent recommended by the detergent manufacturer. Do not use detergents intended for woollens or delicates.</p>
The  symbol is lit on the display panel. Foam may also be leaking from the detergent drawer.	<p>Have you used too much detergent?</p> <p>Mix one tablespoon of fabric softener with 1/2 litre of water and pour it into compartment <b>II</b> (not suitable for outdoor clothing, sportswear or items made with down).</p> <p>Use less detergent for the next wash cycle.</p>
Loud noises, vibrations and machine “wandering” during the spin cycle.	<ul style="list-style-type: none"> <li>■ Is the appliance level? Level the appliance. → <i>Page 20</i></li> <li>■ Are the appliance's feet secured? Secure the appliance's feet. → <i>Page 20</i></li> <li>■ Have the transportation securing means been removed? Remove the transportation securing means. → <i>Page 16</i></li> </ul>
The display panel/indicator lights do not work while the appliance is running.	<ul style="list-style-type: none"> <li>■ Has there been a power failure?</li> <li>■ Have the fuses blown/has the circuit breaker tripped? Switch on the circuit breaker/replace the fuses.</li> <li>■ If the fault occurs repeatedly, call the after-sales service.</li> </ul>
There are noises after the programme starts ActiveOxygen Refresh  .	<p>Not a fault – the appliance is filled with water to create mist; operating noises from the fan and pump can be heard when it is doing this.</p>
Water stains on dry laundry after the ActiveOxygen Refresh  programme.	<ul style="list-style-type: none"> <li>■ Was residual water removed before laundry was added?</li> <li>■ Level the appliance. The active oxygen treatment can only work properly if the appliance is levelled correctly. → <i>Page 20</i></li> </ul>
Noises can be heard after the ActiveOxygen Refresh  programme.	<p>Active oxygen leaves a specific odour on the laundry following treatment. Shake out the laundry briefly.</p>
Odour has not been removed satisfactorily after the ActiveOxygen Refresh  programme.	<ul style="list-style-type: none"> <li>■ The active oxygen treatment is less effective if the drum is dirty. Run the  <b>Drum Clean</b> programme before using the appliance for the first time, and regularly thereafter.</li> <li>■ Have you loaded too much laundry? Do not exceed the maximum load.</li> <li>■ Leave the door and detergent drawer open so that any residual water can evaporate. → <i>Page 45</i></li> </ul>
There is detergent residue on the laundry.	<ul style="list-style-type: none"> <li>■ Some phosphate-free detergents contain water-insoluble residue.</li> <li>■ Select  <b>Rinse</b> or brush the laundry after washing.</li> </ul>
- <b>P</b> - appears on the display panel when the cycle is paused.	<ul style="list-style-type: none"> <li>■ The water level is too high. It is not possible to add laundry. Close the door immediately, if necessary.</li> <li>■ Press the  button to resume the programme.</li> </ul>

Faults	Cause/remedy
- P - and  appear on the display panel when the cycle is paused.	The door is unlocked. It is possible to add laundry.
If you cannot rectify a fault yourself (after switching the machine off and then on again) or a repair is required:	
<ul style="list-style-type: none"><li>■ Switch off the appliance and pull the mains plug out of the socket.</li><li>■ Turn off the tap and call the after-sales service.</li></ul>	



## After-sales service

If you cannot rectify a fault yourself, contact customer services. → Cover page

We will always find an appropriate solution in order to avoid unnecessary visits by engineers.

Please give customer services the product number (E no.) and the production number (FD) of the appliance.

E-Nr. _____ FD _____
----------------------

E no.      Product number  
FD        Production number

You can find this information  
\*depending on the model:

On the inside of the door\*/in the opened service flap\* and on the rear of the appliance.

### **Trust the expertise of the manufacturer.**

Contact us for assistance. By doing so, you will ensure that the repairs are carried out by trained service personnel using genuine spare parts.



## Consumption rates

### Energy and water consumption, programme duration and residual moisture for the main washing programmes

(approximate values)

Programme	Load	Energy consumption**	Water consumption**	Programme duration**
Cottons 20 °C	9 kg	0,25 kWh	90 l	2 ¾ h
Cottons 40 °C	9 kg	1,10 kWh	90 l	3 h
Cottons 60 °C	9 kg	1,06 kWh	90 l	2 ¾ h
Cottons Eco 60 °C*	9 kg	1,19 kWh	62 l	4 ¾ h
Cottons 90 °C	9 kg	2,14 kWh	100 l	2 ¾ h
Easy-Care 40 °C	4 kg	0,71 kWh	64 l	2 h
Mix 40 °C	4 kg	0,60 kWh	45 l	1 ¼ h
Delicates / Silk 30 °C	2 kg	0,19 kWh	37 l	¾ h
Wool 30 °C	2 kg	0,19 kWh	41 l	¾ h
Active Oxygen Refresh ☼	1 kg	0,02 kWh	0 l	¾ h

Programme	Approximate information on the residual moisture***			
	WAW32... Max. 1600 rpm	WAW28... Max. 1400 rpm	WAW24... Max. 1200 rpm	WAW20... Max. 1000 rpm
Cottons	44 %	48 %	53 %	62 %
Easy-Care	40 %	40 %	40 %	40 %
Delicates / Silk	30 %	30 %	30 %	30 %
Wool	45 %	45 %	45 %	45 %

\* Program setting with maximum spin speed for testing according to IEC60456.  
The programme temperature information is based on the temperature stated on the care label for the fabrics. The actual washing temperature may deviate from the stated programme temperature for energy-saving reasons.

\*\* Observed values may deviate from the indicated values due to influence of water pressure, hardness and inlet temperature, ambient temperature, type, amount and soiling of laundry, detergent used, fluctuations in power supply and selected additional functions.

\*\*\* Information on residual moisture based on programme-dependent spin-speed limit and maximum loads.



## Technical data

---

**Dimensions:**

850 x 600 x 590 mm

(height x width x depth)

**Weight:**

70 - 85 kg (depending on model)

**Mains connection:**

Mains voltage 220 - 240 V, 50 Hz

Nominal current 10 A

Nominal power 1900 – 2300 W

**Water pressure:**

100 - 1000 kPa (1 - 10 bar)

**Power consumption when switched off:**

0,12 W

**Power consumption when left on:**

0,43 W



## Aqua-Stop warranty

### Only for appliances with Aqua-Stop

In addition to warranty claims against the vendor based on the purchase agreement and to our appliance warranty, we will provide compensation under the following conditions:

1. If water damage is caused due to a fault in our Aqua-Stop system, we will compensate domestic customers for the damage caused.
2. The liability guarantee is valid for the service life of the appliance.
3. It is a prerequisite of all warranty claims that the appliance with Aqua-Stop must have been installed and connected correctly in accordance with our instructions; this also includes a correctly fitted Aqua-Stop extension (genuine accessories). Our warranty does not cover defective feed lines or fittings leading to the Aqua-Stop connection at the tap.
4. Appliances with Aqua-Stop do not need to be supervised during operation, nor secured afterwards by turning off the tap.  
The tap only needs to be turned off if you are away from home for a long period, e.g. for several weeks' holiday.



### **Advice and repair order in the event of faults**

GB 0344 892 8979 (Calls charged at local or mobile rate.)

IE 01450 2655 (0.03 € per minute at peak. Off peak 0.0088 € per minute.)

You can find the contact information for all countries in the attached after-sales service directory.

Robert Bosch Hausgeräte GmbH  
Carl-Wery-Straße 34  
81739 München, GERMANY



9001174977 (9601)