



Register your new Bosch now:
www.bosch-home.com/welcome



**Free standing cooker
HGD74D250E**



BOSCH

[en] Instruction manual

Table of contents

Important safety information	4	Saving energy with your oven	23
Causes of damage	7	Saving energy with the gas hob	23
Damage to the oven.....	7	Environmentally-friendly disposal.....	23
Damage to the plinth drawer.....	7	Tested for you in our cooking studio	24
Set-up, gas and electricity connection	7	Cakes and pastries	24
Gas connection	7	Baking tips	26
Faults in the gas installation/smell of gas	7	Meat, poultry, fish.....	26
Moving the appliance by the gas line or door handle.....	8	Tips for roasting and grilling.....	28
Electrical connection	8	Bakes, gratins, toast with toppings	28
Levelling the cooker	8	Preprepared products.....	29
Wall fixing	8	Special dishes	30
Setting up the appliance	8	Defrosting	30
Measures to be noted during transport.....	8	Drying.....	30
Your new appliance	9	Preserving	31
General information	9	Acrylamide in foodstuffs	31
Cooking area	9	Test dishes	32
Control panel	10	Baking	32
The cooking compartment.....	11	Grilling.....	32
Your accessories	11		
Inserting accessories	11		
Optional accessories	11		
After-sales service products	12		
Before using the oven for the first time	13		
Setting the time	13		
Heating up the oven.....	13		
Cleaning the accessories.....	13		
Making settings on the hob	13		
Advance cleaning of burner cup and cap	13		
Igniting the gas burners.....	13		
Table – Cooking	13		
Suitable pans	14		
Precautions for use	14		
Programming the oven	15		
Type of heating and temperature	15		
Rapid heating	15		
Setting the time functions	15		
Timer	15		
Cooking time	16		
End time.....	16		
Time.....	17		
Childproof lock	17		
Changing the basic settings	17		
Care and cleaning	18		
Cleaning agents	18		
Upper glass cover	19		
Before cleaning	20		
Detaching and refitting the rails.....	20		
Detaching and attaching the oven door.....	20		
Removing and installing the door panels	21		
Troubleshooting	22		
Fault table.....	22		
Replacing the bulb in the oven ceiling light	22		
Glass cover.....	22		
After-sales service	23		
E number and FD number	23		
Energy and environment tips	23		

Additional information on products, accessories, replacement parts and services can be found at www.bosch-home.com and in the online shop www.bosch-eshop.com

Important safety information

Read these instructions carefully. Only then will you be able to operate your appliance safely and correctly. Retain the instruction manual and installation instructions for future use or for subsequent owners.

These instructions are only valid if the appropriate country symbol appears on the appliance. If the symbol does not appear on the appliance, it is necessary to refer to the technical instructions which will provide the necessary instructions concerning modification of the appliance to the conditions of use of the country.

Appliance category: Category 1

Check the appliance for damage after unpacking it. Do not connect the appliance if it has been damaged in transport.

Only allow a licensed professional to connect the appliance and to convert the appliance to a different type of gas. The appliance must be installed (electric and gas connections) in accordance with the instruction and installation manual. An incorrect connection or incorrect settings may lead to serious accidents and damage to the appliance. The appliance manufacturer accepts no liability for damage of this kind. The appliance's warranty becomes void.

Caution: This appliance is for cooking purposes only. It must not be used for other purposes, for example room heating.

This appliance is intended for use up to a maximum height of 2000 metres above sea level.

Caution: The use of a gas cooking appliance results in the production of heat, moisture and products of combustion in the room in which it is installed. Ensure that the kitchen is well ventilated especially when the appliance is in use: keep natural ventilation holes open or install a mechanical ventilation device (mechanical extractor hood).

Prolonged intensive use of the appliance may call for additional ventilation, for example opening of a window, or more effective ventilation, for example increasing the level of mechanical ventilation where present.

This appliance is not designed for operation with an external timer or by remote control.

Do not use inappropriate child safety shields or hob guards. These can cause accidents.

This appliance may be used by children over the age of 8 years old and by persons with reduced physical, sensory or mental capabilities or by persons with a lack of experience or knowledge if they are supervised or are instructed by a person responsible for their safety how to use the appliance safely and have understood the associated hazards.

Children must not play with, on, or around the appliance. Children must not clean the appliance or carry out general maintenance unless they are at least 8 years old and are being supervised.

Keep children below the age of 8 years old at a safe distance from the appliance and power cable.

Always slide accessories into the cooking compartment correctly. See "*Description of accessories*" in the instruction manual.

Risk of fire!

- A draught is created when the appliance door is opened. Greaseproof paper may come into contact with the heating element and catch fire. Do not place greaseproof paper loosely over accessories during preheating. Always weight down the greaseproof paper with a dish or a baking tin. Only cover the surface required with greaseproof paper. Greaseproof paper must not protrude over the accessories.
- Combustible objects that are left in the cooking compartment may ignite. Never store combustible items in the cooking compartment. Never open the appliance door if there is smoke inside. Switch off the appliance and unplug the mains plug or switch off the fuse in the fuse box. Shut off the gas supply.
- Hot oil and fat can ignite very quickly. Never leave hot fat or oil unattended. Never use water to put out burning oil or fat. Switch off the hotplate. Extinguish

flames carefully using a lid, fire blanket or something similar.

- The hotplates become very hot. Never place combustible items on the hob. Never place objects on the hob.
- The appliance becomes very hot, and flammable materials can easily catch fire. Do not store or use any flammable objects (e.g. aerosol cans, cleaning agents) under or in the vicinity of the oven. Do not store any flammable objects inside or on top of the oven.
- When gas hotplates are in operation without any cookware placed on them, they can build up a lot of heat. The appliance and the extractor hood above it may become damaged or be set on fire. Grease residue in the filter of the extractor hood may ignite. Only operate the gas burners with cookware on them.
- The rear of the appliance becomes very hot. This may cause damage to the power cables. Electricity and gas lines must not come into contact with the rear of the appliance.
- Never place flammable objects on the burners or store them in the cooking compartment. Never open the appliance door if there is smoke inside. Switch off the appliance. Pull out the mains plug or switch off the appliance at the circuit breaker in the fuse box. Shut off the gas supply.
- The surfaces of the plinth drawer may become very hot. Only store oven accessories in the drawer. Flammable and combustible objects must not be stored in the plinth drawer.

Risk of burns!

- The appliance becomes very hot. Never touch the interior surfaces of the cooking compartment or the heating elements. Always allow the appliance to cool down. Keep children at a safe distance.
- Accessories and ovenware become very hot. Always use oven gloves to remove accessories or ovenware from the cooking compartment.
- Alcoholic vapours may catch fire in the hot cooking compartment. Never prepare food containing large quantities of drinks with a high alcohol content. Only use small quantities of drinks with a high alcohol

content. Open the appliance door with care.

- The hotplates and surrounding area (particularly the hob surround, if fitted) become very hot. Never touch the hot surfaces. Keep children at a safe distance.
- During operation, the surfaces of the appliance become hot. Do not touch the surfaces when they are hot. Keep children away from the appliance.
- Empty cookware becomes extremely hot when set on a gas hotplate that is in operation. Never heat up empty cookware.
- The appliance becomes hot during operation. Allow the appliance to cool down before cleaning.
- **Caution:** Accessible parts may be hot when the grill is in use. Young children should be kept away from the appliance.
- If the liquefied gas bottle is not upright, liquefied propane/butane can enter the appliance. Intense darting flames may therefore escape from the burners. Components may become damaged and start to leak over time so that gas escapes uncontrollably. Both can cause burns. Always use liquefied gas bottles in an upright position.

Risk of scalding!

- The accessible parts become hot during operation. Never touch the hot parts. Keep children at a safe distance.
- When you open the appliance door, hot steam may escape. Open the appliance door with care. Keep children at a safe distance.
- Water in a hot cooking compartment may create hot steam. Never pour water into the hot cooking compartment.

Risk of injury!

- Scratched glass in the appliance door may develop into a crack. Do not use a glass scraper, sharp or abrasive cleaning aids or detergents.
- Incorrect repairs are dangerous. Repairs may only be carried out, and damaged power and gas lines replaced, by an after-sales engineer trained by us. If the appliance is faulty, unplug the mains plug or switch off the fuse in the fuse box. Shut off the gas supply. Contact the after-sales service.

- Faults or damage to the appliance are dangerous. Never switch on a faulty appliance. Unplug the appliance from the mains or switch off the circuit breaker in the fuse box. Shut off the gas supply. Contact the after-sales service.
- Unsuitable pan sizes, damaged or incorrectly positioned pans can cause serious injury. Observe the instructions which accompany the cookware.
- **Caution:** Glass lids may shatter when heated. Turn off all the burners before shutting the lid. Wait until the oven has cooled down before closing the glass cover.



- If the appliance is placed on a base and is not secured, it may slide off the base. The appliance must be fixed to the base.

Risk of tipping!

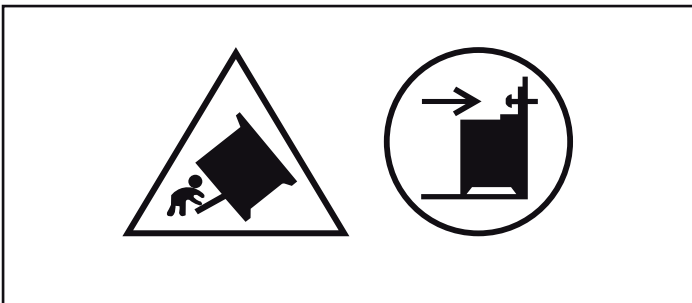

Warning: In order to prevent tipping of the appliance, this stabilizing means must be installed. Refer to the instructions for installation.

Risk of electric shock!

- Incorrect repairs are dangerous. Repairs may only be carried out by one of our trained after-sales engineers. If the appliance is faulty, unplug the mains plug or switch off the fuse in the fuse box. Contact the after-sales service.
- The cable insulation on electrical appliances may melt when touching hot parts of the appliance. Never bring electrical appliance cables into contact with hot parts of the appliance.
- Do not use any high-pressure cleaners or steam cleaners, which can result in an electric shock.
- When replacing the cooking compartment bulb, the bulb socket contacts are live. Before replacing the bulb, unplug the appliance from the mains or switch off the circuit breaker in the fuse box.
- A defective appliance may cause electric shock. Never switch on a defective appliance. Unplug the appliance from the mains or switch off the circuit breaker in the fuse box. Contact the after-sales service.

Risk of fire!

- Loose food residues, grease and meat juices may catch fire during the Self-cleaning cycle. Remove coarse dirt from the cooking compartment and from the accessories before every Self-cleaning cycle.
- The appliance will become very hot on the outside during the Self-cleaning cycle. Never hang combustible objects, e.g. tea towels, on the door handle. Do not place anything against the front of the oven. Keep children at a safe distance.

Risk of burns!

- The cooking compartment will become very hot during the Self-cleaning cycle. Never open the appliance door or move the locking latch by hand. Allow the appliance to cool down. Keep children at a safe distance.
-  The appliance will become very hot on the outside during the Self-cleaning cycle. Never touch the appliance door. Allow the appliance to cool down. Keep children at a safe distance.

Causes of damage

Hob

Caution!

- Only use the burners when cookware has been placed on top. Do not heat up empty pots or pans. The saucepan base will be damaged.
- Only use pots and pans with an even base.
- Place the pot or pan centrally over the burner. This will optimise transfer of the heat from the burner flame to the pot or pan base. The handle does not become damaged, and greater energy savings are guaranteed.
- Ensure that the gas burners are clean and dry. The burner cup and burner cap must be positioned exactly.
- Ensure that the top cover is not closed when the oven is started up.

Damage to the oven

Caution!

- Accessories, foil, greaseproof paper or ovenware on the cooking compartment floor: do not place accessories on the cooking compartment floor. Do not cover the cooking compartment floor with any sort of foil or greaseproof paper. Do not place ovenware on the cooking compartment floor if a temperature of over 50 °C has been set. This will cause heat to accumulate. The baking and roasting times will no longer be correct and the enamel will be damaged.
- Water in a hot cooking compartment: do not pour water into the cooking compartment when it is hot. This will cause

steam. The temperature change can cause damage to the enamel.

- Moist food: do not store moist food in the cooking compartment when it is closed for prolonged periods. This will damage the enamel.
- Fruit juice: when baking particularly juicy fruit pies, do not pack the baking tray too generously. Fruit juice dripping from the baking tray leaves stains that cannot be removed. If possible, use the deeper universal pan.
- Cooling with the appliance door open: only allow the cooking compartment to cool when it is closed. Even if the appliance door is only open a little, front panels of adjacent units could be damaged over time.
- Very dirty door seal: If the door seal is very dirty, the appliance door will no longer close properly when the appliance is in use. The fronts of adjacent units could be damaged. Always keep the door seal clean.
- Appliance door as a seat, shelf or worktop: Do not sit on the appliance door, or place or hang anything on it. Do not place any cookware or accessories on the appliance door.
- Inserting accessories: depending on the appliance model, accessories can scratch the door panel when closing the appliance door. Always insert the accessories into the cooking compartment as far as they will go.
- Carrying the appliance: do not carry or hold the appliance by the door handle. The door handle cannot support the weight of the appliance and could break.

Damage to the plinth drawer

Caution!

Do not place hot objects in the plinth drawer. It could be damaged.

Set-up, gas and electricity connection

Gas connection

Installation must only be performed by an approved expert or a licensed after-sales service engineer in accordance with the instructions specified under "Gas connection and conversion to a different gas type".

For the licensed expert or after-sales service

Caution!

- The setting conditions for this appliance are specified on the rating plate on the back of the appliance. The gas type set in the factory is marked with an asterisk (*).
- Before setting up the appliance, check the grid access conditions (gas type and gas pressure) and ensure that the gas setting of the appliance meets these conditions. If the appliance settings have to be changed, follow the instructions in the section "Gas connection and conversion to a different gas type".
- This appliance is not connected to a waste gas main. It must be connected and commissioned in accordance with the

installation conditions. Do not connect the appliance to a waste gas main. All ventilation regulations must be observed.

- The gas connection must be made via a fixed, i.e. not mobile connection (gas line) or via a safety hose.
- If using the safety hose, ensure that the hose is not trapped or crushed. The hose must not come into contact with hot surfaces.
- The gas line (gas pipe or safety hose) can be connected to the right or left-hand side of the appliance. The connection must have an easily accessible locking device.

Faults in the gas installation/smell of gas

If you notice a smell of gas or faults in the gas installation, you must

- immediately shut off the gas supply and/or close the gas cylinder valve
- immediately extinguish all naked flames and cigarettes
- switch off electrical appliances and lights
- open windows and ventilate the room
- call the after-sales service or the gas supplier

Moving the appliance by the gas line or door handle

Do not move the appliance while holding the gas line; the gas pipe could be damaged. There is a risk of a gas leak! Do not move the appliance while holding it by the door handle. The door hinges and door handle could be damaged.

Electrical connection

Caution!

- Have the appliance set up by your after-sales service. A 16 A fuse is required for connection. The appliance is designed for operation at 220-240 V.
- If the electricity supply drops below 180 V, the electrical ignition system does not work.
- Any damage arising from the appliance being connected incorrectly will invalidate the guarantee.
- If the supply cord is damaged, it must be replaced by the manufacturer, its service agent or similarly qualified persons in order to avoid a hazard.

For the after-sales service

Caution!

- The appliance must be connected in accordance with the data on the rating plate.
- Only connect the appliance to an electrical connection that meets the applicable provisions. The socket must be easily accessible so that you can disconnect the appliance from the electricity supply if necessary.
- Please ensure the availability of a multi-pin disconnecting system.
- Never use extension cables or multiple plugs.
- For safety reasons, this appliance must only be connected to an earthed connection. If the safety earth terminal does not comply with regulations, safety against electrical hazards is not guaranteed.
- You must use a H 05 W-F type cable or equivalent for the appliance connection.

Levelling the cooker

Always place the cooker directly on the floor.

1. Pull out the plinth drawer and lift it up and out. There are adjustable feet at the front and rear on the inside of the plinth.
2. Use an Allen key to raise or lower the adjustable feet as necessary until the cooker is level (picture A).
3. Push the plinth drawer back in (picture B).

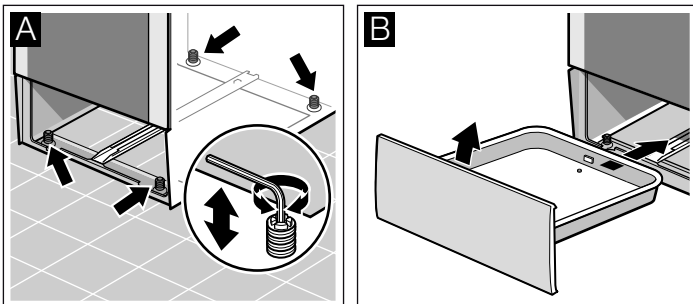

Wall fixing

To prevent the cooker from tipping over, you must fix it to the wall using the enclosed bracket. Please observe the installation instructions for fixing the oven to the wall.

Setting up the appliance

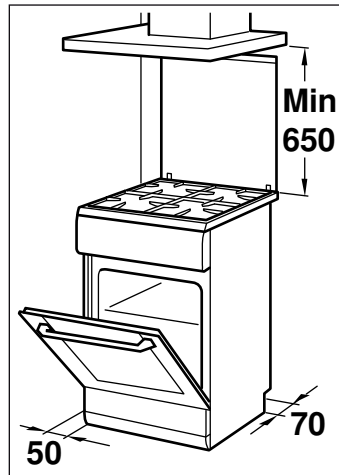

- The appliance must be set up directly on the kitchen floor and in line with the specified dimensions. The appliance must not be set up on any other object.
- The distance between the top edge of the oven and the bottom edge of the extractor hood must meet the requirements of the extractor hood manufacturer.
- Ensure that the appliance is not moved again after set up. The distance from the high output burner or wok burner to the fronts of the adjacent units or the wall must be at least 50 mm.

Measures to be noted during transport

Secure all mobile parts in and on the appliance using an adhesive tape that can be removed without leaving any traces. Push all accessories (e.g. baking tray) into the corresponding slots with cardboard at the edges, in order to avoid damaging the appliance. Place cardboard or similar between the front and rear side to prevent knocks against the inside of the glass door. Secure the door and, if available, the top cover to the appliance sides using adhesive tape.

Keep the original appliance packaging. Only transport the appliance in the original packaging. Observe the transport arrows on the packaging.

If the original packaging is no longer available

pack the appliance in protective packaging to guarantee sufficient protection against any transport damage.

Transport the appliance in an upright position. Do not hold the appliance by the door handle or the connections on the rear, as these could be damaged. Do not place any heavy objects on the appliance.

Your new appliance

In this section you will find information on the appliance, the operating modes and the accessories.

General information

The design depends on the respective appliance model.

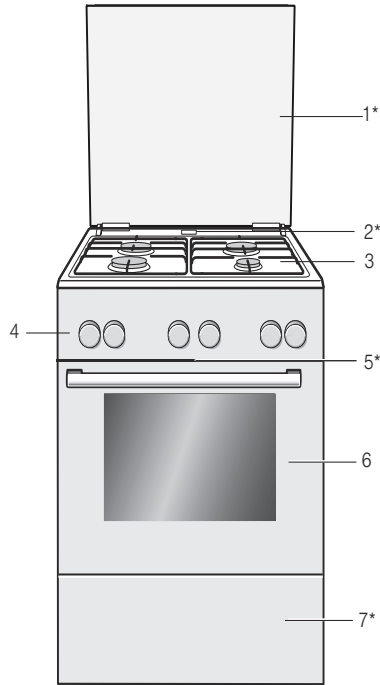

Explanations

- | | |
|----|--------------|
| 1* | Hob cover** |
| 2* | Steam outlet |

Caution!

When the oven is in operation, hot steam escapes here.

- | | |
|----|-----------------|
| 3 | Hob** |
| 4 | Control panel** |
| 5* | Cooling fan |
| 6 | Oven door** |
| 7* | Plinth drawer** |

* Optional (available for some appliances)

** Depending on the appliance model, details may vary.

Cooking area

Here is an overview of the control panel. The design depends on the respective appliance model.

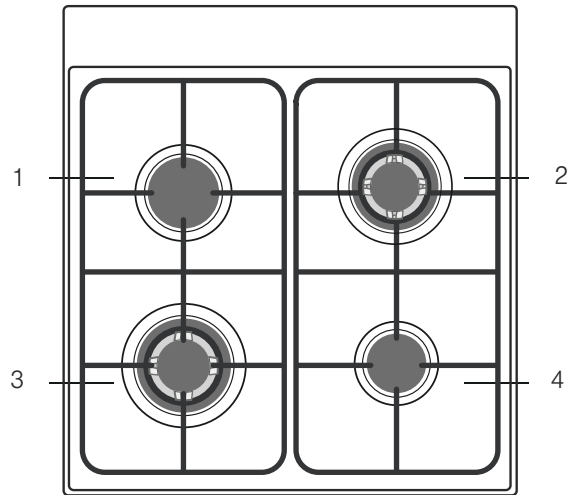

Explanatory notes

- | | |
|---|-----------------|
| 1 | Standard burner |
| 2 | Mini wok burner |
| 3 | Wok burner |
| 4 | Economy burner |

Control panel

Details may vary depending on the appliance model.

Function control knob

The function control knob is used to select the type of heating.

Setting	Use
○ Zero setting	The oven is off.
🌀 3D Hot air*	For cakes and pastries. These can be baked on three levels. A fan located on the rear wall of the oven disperses the heat evenly.
☐ Top and bottom heating*	For cakes, au gratin dishes, and lean meat roasts, e.g. veal or game, on one level. The heat is provided by the bottom and top heating elements.
🍕 Pizza function	Quick preparation of frozen foods without pre-heating, e.g., pizza, chips or puff pastry. The heat comes from the bottom element and the fan on the rear wall.
🔥 Grill with hot air	For roasting joints of meat, poultry and fish. The grill heating element and the fan switch on and off alternately. The fan circulates the heat generated by the grill around the food.
☐ Large surface grill	For grilling steaks, sausages, fish and toasting bread. The entire surface below the grill heating element is heated.
☐ Grill, small surface area	For grilling a small number of steaks or sausages or small amounts of fish, and toasting bread. Only the central area of the grill heating element heats up.
☐ Bottom heating	Confits, baking and cooking au gratin. The heat comes from the bottom heating element.
🌀* Defrosting	Defrosting, e.g. meat, poultry, bread and cakes. The fan circulates the hot air around the food.
💡 Light	For turning on the oven light.

* Type of heating used to determine the appliance's energy efficiency rating according to EN60350.

Once a type of heating has been selected the oven light is turned on.

Temperature selector

Use the temperature selector to set the temperature and the grill setting.

Positions	Function
●	Zero position Oven not hot.
50-270	Temperature range Temperature in °C.
1, 2, 3	Grill settings Grill settings for the ☐ Grill, small area and ☐ Grill, large area. Setting 1 = low Setting 2 = medium Setting 3 = high

While the oven is heating up, the ↓ temperature symbol lights up in the display. If heating is interrupted, the symbol goes out. For some settings, it does not light up.

Burner knob

You can adjust the heat setting of the hotplates using the four burner knobs.

Positions	Function/gas oven
○	Zero position The oven is switched off.
🔥	Ignition position Ignition position
🕒	Settings area Large flame = highest setting Economy flame = lowest setting

There is a limit stop at the end of the settings area. Do not turn the timer beyond this.

Buttons and display

You can use the buttons to set various additional functions. On the display, you can read the values that you have set.

Button	Use
»»»	Rapid heating Heats up the oven particularly quickly.
🕒	Time-setting options Selects the timer ⌚, cooking time ⌚, end time ⌚ and clock ⌚.
🔒	Childproof lock Locks and unlocks oven functions.
-	Minus Decreases the set values.
+	Plus Increases the set values.

The time-setting option that is currently selected in the display is indicated by brackets [] around the corresponding symbol. Exception: For the clock, the ⌚ symbol only lights up if the time is being changed.

Buttons

The sensors are located under the individual buttons. They must not be pressed too firmly. Only touch the corresponding symbol.

LED lighting button

You can use this button to switch on the LED lighting on the glass cover.

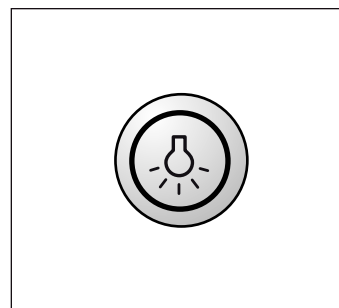

The LED lighting on the glass cover is operated as follows:

The glass cover on your appliance is equipped with maintenance-free LED lighting.

Press the LED lighting button to switch the glass cover's LED lighting on.

Press this button again to switch the lighting off.

The lighting on the appliance must only be repaired by our after-sales service or by authorised technicians.

Note: Closing the glass cover while pressing the lighting button will switch the LED lighting off. The LED lighting will switch back on when the cover is opened again.

The cooking compartment

The oven light is located in the cooking compartment. A cooling fan protects the oven from overheating.

Light

The oven light remains on while the oven is working.

However, the light can be turned on without the oven being on by setting the function control knob to .

Cooling fan

The cooling fan switches on and off as required. The hot air escapes above the door.

So that the cooking compartment cools down more quickly after operation, the cooling fan continues to run for a certain period afterwards.

Caution!

do not cover the ventilation slots. Otherwise the oven will overheat.

Your accessories

The accessories supplied with your appliance are suitable for making many meals. Ensure that you always insert the accessories into the cooking compartment the right way round.

There is also a selection of optional accessories, with which you can improve on some of your favourite dishes, or simply to make working with your oven more convenient.



Wire rack

For ovenware, cake tins, joints, grilled items and frozen meals.

Insert the wire rack with the open side facing the oven door and the curvature pointing downwards .



Enamel baking tray

For cakes and biscuits.

Slide in the baking tray with the sloping edge facing the oven door.



Universal pan

For moist cakes, pastries, frozen meals and large roasts. It can also be used to catch dripping fat when you are grilling directly on the wire rack.

Slide in the universal pan with the sloping edge facing the oven door.

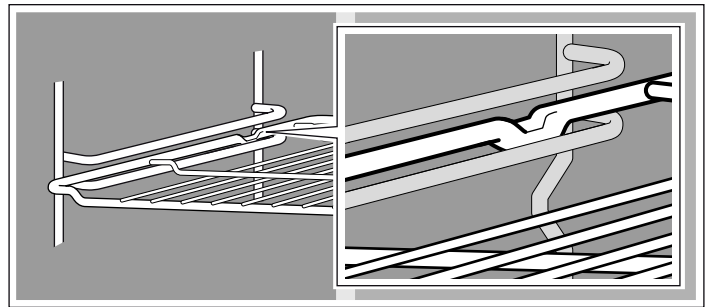

Note: The accessories may deform when they become hot. Once they cool down again, they regain their original shape. This does not affect their operation.

Hold the baking tray securely on the sides with both hands and push it parallel into the frame. Avoid movements to the right or left when pushing the baking tray in. Otherwise, it will be difficult to push the tray in and the enamelled surfaces could be damaged.

You can buy accessories from the after-sales service, from specialist retailers or online. Please specify the HEZ number.

Optional accessories

You can buy optional accessories from your after-sales service or from specialist retailers. You will find a variety of suitable products for your oven in our brochures and on the Internet. The availability of optional accessories and the options for ordering them on the internet vary depending on the country. Information on purchasing accessories can be found in the sales documents.

Not every optional accessory is suitable for every appliance. When purchasing, always quote the complete identification number (E no.) of your appliance.

Inserting accessories

You can insert the accessories into the cooking compartment at 5 different levels. Always insert them as far as they will go so that the accessories do not touch the door panel.

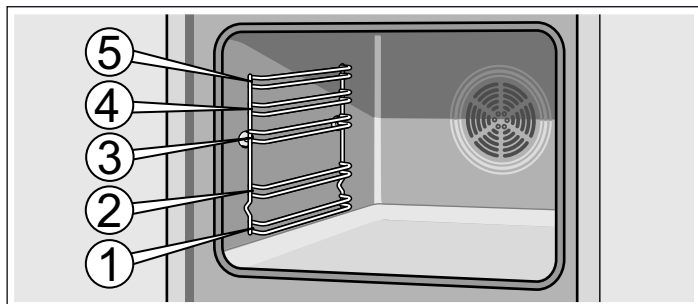

The accessories can be pulled out approximately halfway until they lock in place. This allows dishes to be removed easily.

When sliding the accessories into the cooking compartment, ensure that the indentation is at the back. They can only lock in place from this position.

Optional accessories	HEZ number	Function
Pizza tray	HEZ317000	Particularly good for pizza, frozen meals and round tarts. You can use the pizza tray instead of the universal pan. Slide the tray in above the wire rack and proceed according to the instructions in the tables.
Insert wire rack	HEZ324000	For roasting. Always place the grill wire rack on the universal pan. This ensures that dripping fat and meat juices are collected.
Grill tray	HEZ325000	Used for grilling instead of the grill wire rack or used as a splatter guard to protect the oven from becoming heavily soiled. Only use the grill tray with the universal pan. Grilling on the grill tray: only shelf positions 1, 2 and 3 can be used. The grill tray as a splash guard: the universal pan is inserted together with the grill tray under the wire rack.
Baking stone	HEZ327000	The baking stone is perfect for preparing home-made bread, bread rolls and pizzas which require a crispy base. The baking stone must always be preheated to the recommended temperature.
Enamel baking tray	HEZ331003	For cakes and biscuits. Place the baking tray in the oven with the sloping edge towards the oven door.
Enamel baking tray with non-stick coating	HEZ331011	The baking tray is ideal for laying out cakes and biscuits. Place the baking tray in the oven with the sloping edge towards the oven door.
Universal pan	HEZ332003	For moist cakes, pastries, frozen meals and large roasts. Can also be used under the wire rack to catch fat or meat juices. Place the universal pan in the oven with the sloping edge towards the oven door.
Universal pan with non-stick coating	HEZ332011	This universal pan is ideal for moist cakes, pastries, frozen meals and large roasts. Place the universal pan in the oven with the sloping edge towards the oven door.
Lid for the Profi extra-deep pan	HEZ333001	The lid converts the Profi extra-deep pan into the Profi roasting dish.
Profi extra-deep pan with insert wire rack	HEZ333003	Particularly suitable for preparing large quantities of food.
Pull-out rail		
3-level shelf rail	HEZ338352	With the pull-out rails at levels 1, 2 and 3, you can pull the accessories out without them tilting. 3-level shelf rail – not suitable for appliances fitted with a rotary spit.
3-level shelf rail with stop function	HEZ338357	With the pull-out rails on level 1, 2 and 3, the accessories can be fully pulled out without tilting. The pull-out rails click into place so that baking trays can be easily inserted. The 3-level telescopic shelf with stop function is not suitable for appliances fitted with a rotary spit.
Wire rack	HEZ334000	For ovenware, cake tins, roasts, grilling and frozen meals.
Glass roasting dish	HEZ915001	The glass roasting dish is suitable for pot roasts and bakes. Ideal for programmes and automatic roasting.

After-sales service products

You can obtain suitable care and cleaning agents and other accessories for your domestic appliances from the after-sales

service, specialist retailers or (in some countries) online via the e-Shop. Please specify the relevant product number.

Cleaning cloths for stainless-steel surfaces	Product no. 311134	Reduces the build-up of dirt. Impregnated with a special oil for perfect maintenance of your appliance's stainless-steel surfaces.
Oven and grill cleaning gel	Product no. 463582	For cleaning the cooking compartment. The gel is odourless.
Microfibre cloth with honeycomb structure	Product no. 460770	Especially suitable for cleaning delicate surfaces, such as glass, glass ceramic, stainless steel or aluminium. The microfibre cloth removes liquid and grease deposits in one go.
Door lock	Product no. 612594	To prevent children from opening the oven door. The locks on different types of appliance door are screwed in differently. See the information sheet supplied with the door lock.

Before using the oven for the first time

In this section, you can find out what you must do before using your oven to prepare food for the first time. First read the section on *Safety information*.

Setting the time

Once the oven has been connected, the \ominus symbol and four zeros are shown flashing on the display panel. Set the time.

1. Press the \ominus button.

The display shows the time **12:00**.

2. Set the time with the buttons **+** or **-**.

The programmed time is displayed after a few seconds.

Heating up the oven

To remove the new cooker smell, heat up the oven when it is empty and closed. An hour of Top/bottom heating \square at 240 °C is ideal for this purpose. Ensure that no packaging remnants have been left in the cooking compartment.

Keep the kitchen ventilated the whole time the oven is on.

1. Use the function selector to set Top/bottom heating \square .
2. Set the temperature selector to 240 °C.

After an hour, switch off the oven. To do so, turn the function selector to the off position.

Cleaning the accessories

Before you use the accessories for the first time, clean them thoroughly with hot soapy water and a soft dish cloth.

Making settings on the hob

Your hob is equipped with four gas burners. The following information explains how to light the gas burners and set the size of flame.

Advance cleaning of burner cup and cap

Clean the burner cap (1) and cup (2) with water and washing-up liquid. Dry the individual parts carefully.

Place the burner cup and cap back on the burner shell (5). Ensure that the igniter (3) and flame safety pin (4) are not damaged.

The nozzle (6) must be dry and clean. Always position the burner cap exactly over the burner cup.

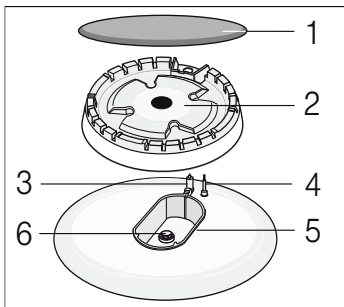

Igniting the gas burners

Always position the burner cap exactly onto the burner cup. The openings in the burner cup must remain unobstructed at all times. All parts must be dry.

1. Open the upper cooker cover. The upper cover must remain open whilst the cooker is in operation.
2. Turn the control for the required hotplate anti-clockwise to the ignition position \star . This starts the ignition process.
3. Press and hold the hotplate control for 1-3 seconds. Gas begins to flow out and the gas burner ignites.

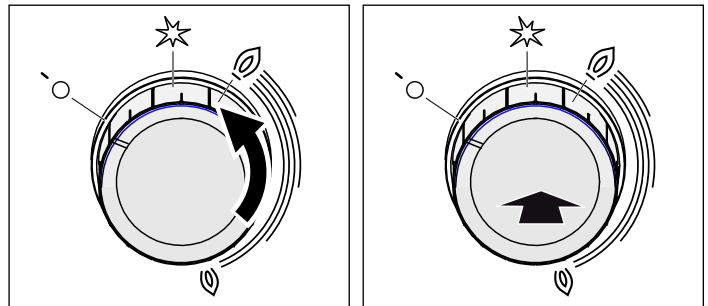

The safety pilot is activated. If the gas flame goes out, the gas supply is automatically cut off by the safety pilot.

4. Set the required flame size. Between the Off \circ setting and the @ setting, the flame is not stable. Therefore, always choose a setting between the large flame @ and small flame @ .
5. If the flame goes out again, repeat the process from step 2.
6. To finish cooking, turn the hotplate control clockwise to the Off \circ position.

The hotplate control should not be turned to the ignition position for longer than 15 seconds. If the burner does not light within 15 seconds, wait at least one minute. Then repeat the ignition process.

⚠ Caution!

If, after switching the cooker off, you turn the burner control while the cooker is still hot, gas will escape. If you do not turn the hotplate control to the ignition position \star within 60 seconds, the gas supply will be cut off.

The gas burner does not ignite

If there is a power cut or if the ignition plugs are damp, you can light the gas burners with a gas lighter or a match.

Table – Cooking

Select the right pan size for each hotplate. The diameter of the pot or pan base should be the same as that of the hotplate.

Cooking times may vary depending on the type of food, its weight and quality. You yourself can best judge the optimal cooking time.

Use as little water as possible when cooking, so that the food retains its vitamins and minerals. Select short cooking times so that the vegetables remain firm and full of nutrients.

Example	Food	Hotplate	Heat setting
Melting	Chocolate, butter, margarine	Economy burner	Small flame
Warming	Stock, tinned vegetables	Standard burner Electric hotplate**	Small flame 1-2
Heating and keeping warm	Soups	Economy burner Electric hotplate**	Small flame 1-2
Steaming*	Fish	Standard burner Electric hotplate**	Between large and small flame 3-4
Braising*	Potatoes and other vegetables, meat	Standard burner Electric hotplate**	Between large and small flame 3-4
Boiling*	Rice, vegetables, meat dishes (with sauces)	Standard burner Electric hotplate**	High flame 5-6
Roasting	Pancakes, potatoes, schnitzel, fish fingers	High-output burner** Wok burner**	Between large and small flame

* If you are using a pan with a lid, turn the flame down as soon as it reaches boiling point.

** Optional. Available for some appliances, depending on the appliance model (for frying on the wok burner, we recommend that you use a wok)

Suitable pans

Burner	Minimum cookware diameter	Maximum cookware diameter
Wok burner 4 kW	24 cm	28 cm
Mini wok burner 3.5 kW*	24 cm	28 cm
Standard burner 1.7 kW	18 cm	24 cm
Economy burner 1 kW	12 cm	18 cm

* LPG: 3.3 kW

Precautions for use

The following advice is intended to help you save energy and prevent pan damage:

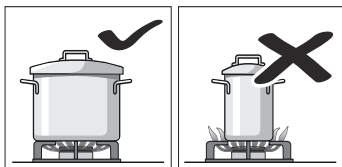

Use pans which are the right size for each burner.
Do not use small pans on large burners. The flame must not touch the sides of the pan.

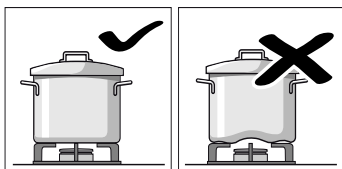

Do not use damaged pans, which do not sit evenly on the hob. Pans may tip over.
Only use pans with a thick, flat base.

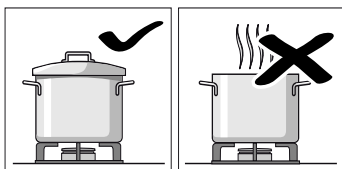

Do not cook without using a lid and make sure the lid is properly fitted. This wastes energy.

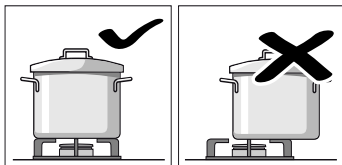

Always place the ovenware centrally over the burner. Otherwise, there is a risk that it may tip over.

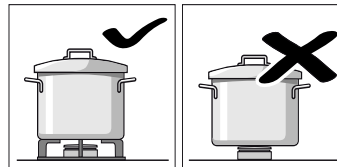

Place the pans on the pan supports, never directly on the burner.

Make sure that the pan supports and burner caps are correctly positioned before using the appliance.

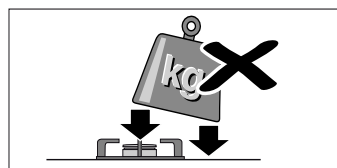

Pans should be placed on the hob carefully.

Do not strike the hob and do not place excessive weight on it.

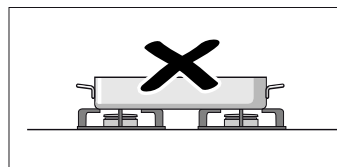

Never use two burners or heat sources to heat one single pan.

Do not use grill pans, earthenware casserole dishes, etc. for a long period of time on maximum power.

Programming the oven

There are different ways to programme the oven. Programming the type of heating, temperature or grill power. The oven can be programmed with the cooking time (duration) and the end time for each dish. For more information, see the chapter *Setting the time functions*.

Note: We recommend preheating the oven before inserting the food in order to avoid condensation on the oven glass.

Type of heating and temperature

Example in the picture: Top/bottom heating at 190 °C .

1. Use the function selector to set the type of heating.



2. Set the temperature or grill setting using the temperature selector.

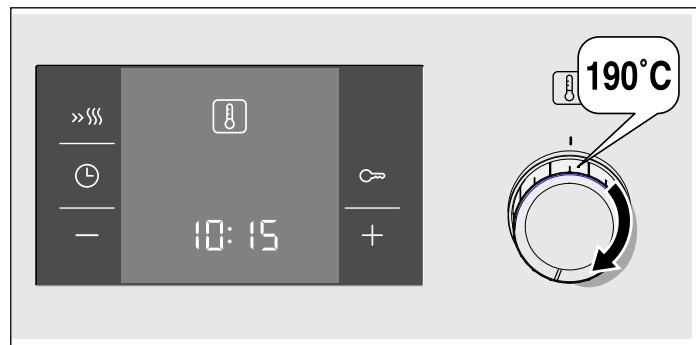

The oven heats up.

Switching off the oven

Turn the function selector to the off position.

Changing the settings

The type of heating and temperature or grill setting can be changed at any time using their respective selectors.

Rapid heating

With the rapid heating function, the oven reaches the programmed temperature very quickly.

Rapid heating must be used for temperatures of more than 100 °C. The following types of heating are appropriate:

- 3D hot air 
- Top and bottom heating 

To ensure uniform cooking, the food must not be put into the oven until rapid heating has been completed.

1. Select the temperature and type of heating required.
2. Briefly press the >>SSS button.

The display panel shows the >>SSS symbol. The oven will begin to heat up.

End of rapid heating

A beep will sound. The >>SSS symbol disappears from the display panel. Put the food in the oven.

Cancelling rapid heating

Press the >>SSS button. The >>SSS symbol disappears from the display panel.

Setting the time functions

This oven has various time functions. The  sensor activates the menu and moves through the different functions. The time symbols remain lit up while settings are programmed. The square brackets [] indicate the time function selected. You can modify an already programmed time function directly with the sensors **+** or **-**, provided the time symbol is situated between square brackets [].

Timer

The timer works independently of the oven. The timer has its own beep. This can be used to distinguish whether the time set for the timer or the automatic oven shut-off have finished (cooking time).

1. Press the button once .

The time symbols light up on the display panel, the square brackets are next to .

2. Set the timer using the **+** or **-** buttons.

Value suggested for the **+** button = 10 minutes.

Value suggested for the **-** button = 5 minutes.

The programmed time is shown after a few seconds. The time set for the timer starts to count down. The symbol  lights up

on the display panel and the timer's progress is shown. The other time symbols switch off.

The time set for the timer has elapsed

A beep will sound. The display panel will show **00:00**. Switch off the timer using the .

Changing the time on the timer.





Change the time set for the timer using the **+** or **-** buttons. The new time is shown after a few seconds.

Cancelling the timer

Resetting the timer to **00:00** with the button **-**. The new time is shown after a few seconds. The timer switches off.

Viewing the time settings

If several time functions are programmed, the corresponding symbols light up on the display panel. The symbol for the time function in the foreground is in brackets.

To view the timer , the cooking time , the end time  or the actual time , press the  sensor repeatedly until the brackets are around the required symbol. The corresponding value will be shown for a few seconds on the display panel.

Cooking time

The oven allows you to set the cooking time for each type of food. The oven switches off automatically when the cooking time has finished. This avoids interrupting other tasks to switch the oven off or exceeding the cooking time by mistake.

Example in the picture: cooking time: 45 minutes.

1. Select the type of heating using the function control knob.
2. Select the temperature or grill power level with the temperature control knob.
3. Press the  button twice.

The display panel will show **00:00**. The time symbols light up, the brackets are located next to .

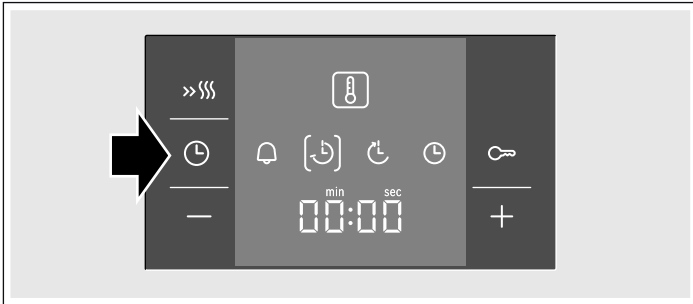



4. Set the cooking time with the **+** or **-** buttons.
Value suggested for the **+** button = 30 minutes.
Value suggested for the **-** button = 10 minutes.



The oven will switch on after a few seconds. The display panel shows the cooking time elapsed and the  symbol is displayed. The other time symbols switch off.

The cooking time has finished

A beep will sound. The oven will stop heating. The display panel will show **00:00**. Press the  button. Programme a new cooking time with the **+** or **-** buttons. Or press the  button twice and turn the function control knob to the zero setting. The oven is off.

Changing the cooking time





Change the cooking time with the **+** or **-** buttons. The new time is shown after a few seconds. If the timer has been programmed, first press the  button.

Cancelling the cooking time

Reset the cooking time to **00:00** with the button **-**. The new time is shown after a few seconds. The time has been cancelled. If the timer has been programmed, first press the  button.

Viewing the time settings

If several time functions are programmed, the corresponding symbols light up on the display panel. The symbol for the time function in the foreground is in brackets.



To view the timer , the cooking time , the end time  or the actual time , press the  sensor repeatedly until the brackets are around the required symbol. The corresponding value will be shown for a few seconds on the display panel.

End time

The oven allows you to set the time when you want the food ready. The oven switches on automatically and switches off at the set time. E.g. the food may be placed in the oven in the morning and the oven set so that it is ready at midday.

Please ensure that the food will not go off if it is in the oven for too long.

Example in the picture: It is now 10:30 AM, the cooking time is 45 minutes and the oven should switch off at 12:30 PM.



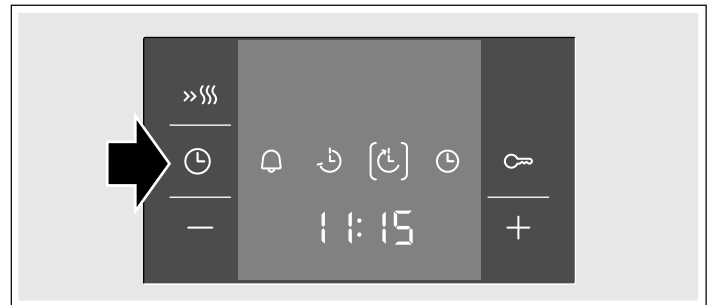

1. Set the function control knob.
2. Set the temperature control knob.
3. Press the  button twice.
4. Set the cooking time with the **+** or **-** buttons.
5. Press the  button.

The brackets are shown next to . The time the dish will be ready is displayed.





6. Delay the end time using the buttons **+** or **-**.



The oven displays the programmed time after a few seconds and is set to standby. The time when the dish will be ready is displayed and the end time  symbol will be shown in brackets. The symbols  and  turn off. When the oven is turned on, cooking time progress is shown and the symbol  appears in brackets. The symbol  is turned off.

The cooking time has finished

A beep will sound. The oven will stop heating. The display panel will show **00:00**. Press the  button. Programme a new cooking time with the **+** or **-** buttons. Or press the  button twice and turn the function control knob to the zero setting. The oven is off.

Changing the end time





Change the end time using the buttons **+** or **-**. The new time is shown after a few seconds. If the timer has been programmed, first press the  button twice. Do not change the end time if the cooking time has already started to count down. The final result may not be the same.

Cancelling the end time

Reset the end time to the current time by pressing **-**. The new time is shown after a few seconds. The oven switches on. If the timer has been programmed, first press the  button twice.

Viewing the time settings

If several time functions are programmed, the corresponding symbols light up on the display panel. The symbol for the time function in the foreground is in brackets.

To view the timer , the cooking time , the end time  or the actual time , press the  sensor repeatedly until the brackets are around the required symbol. The corresponding value will be shown for a few seconds on the display panel.

Time

Once the oven has been connected or after a power cut, a flashing  symbol and four zeros are shown on the display panel. Set the time.

1. Press the  button.

The display panel displays the time **12.00**.

2. Set the time with the buttons **+** or **-**.

The programmed time is displayed after a few seconds.

Changing the time

No other time function can be programmed.

1. Press the  button four times.

The time symbols light up on the display panel, the brackets are located next to .

2. Adjust the time with the buttons **+** or **-**.

The programmed time is displayed after a few seconds.

Hiding the clock

You can hide the clock. For more information, please refer to the section *Changing the basic settings*.

Childproof lock

The oven includes a childproof lock to prevent it being turned on accidentally.

The oven does not react to any setting. The timer and time can be programmed when the childproof lock is on.

When the heating type and temperature or grill level are programmed, the childproof lock turns off the heating.

Activating the childproof lock

No cooking time or end time should already be set.

Press the  button for approximately four seconds.

The display panel shows the symbol . The childproof lock is now activated.





Turning off the childproof lock

Press the  button for approximately four seconds.

The  symbol in the display panel goes off. The childproof lock is now deactivated.

Changing the basic settings

This oven has different basic settings. The settings can be adapted to the user's own needs.

Basic settings	Selection 1	Selection 2	Selection 3
 / Time indicator	always*	only with the button 	-
 Duration of signal after the cooking time or the time set on the timer has elapsed	approx. 10 sec	approx. 2 min.*	approx. 5 min
 Time until a setting is applied	approx. 2 sec	approx. 5 sec.*	approx. 10 sec.

* Default setting

No other time function can be programmed.

1. Press the  button for approximately 4 seconds.

The display panel will show the current basic setting for the time, e.g.  / for the Selection 1.

2. Set the basic setting using the buttons **+** or **-**.

3. Confirm with the  button.

The display panel shows the following basic setting. Using the button  select the levels and using the buttons **+** or **-** make the setting.

4. Press the  button for approximately 4 seconds.

All basic settings have been applied.

The basic settings can be changed again at any time.

Care and cleaning

With attentive care and cleaning, your hob and oven will retain its looks and remain in good working order for a long time. We will explain here how you should care for and clean them correctly.

Notes

- Slight differences in the colours on the front of the oven are caused by the use of different materials, such as glass, plastic and metal.
- Shadows on the door panel which look like streaks, are caused by reflections made by the oven light.
- Enamel is baked on at very high temperatures. This can cause some slight colour variations. This is normal and does not affect operation. The edges of thin trays cannot be completely enamelled. As a result, these edges can be rough. This will not impair the anti-corrosion protection.

Cleaning agents

Damage to the various different surfaces caused by using the wrong cleaning agent can be avoided by observing the following instructions.

When cleaning the hob do not use

- undiluted washing-up liquid or dishwasher detergent,
- scouring pads,
- abrasive cleaning agents such as oven cleaner or stain remover,
- high-pressure cleaners or steam jets.
- Do not clean individual parts in the dishwasher.

When cleaning the oven do not use

- sharp or abrasive cleaning agents,
- cleaning agent with a high alcohol content,
- scouring pads,
- high-pressure cleaners or steam jets.
- Do not clean individual parts in the dishwasher.

Wash new sponges thoroughly before first use.

Zone	Cleaning agent
Stainless steel surfaces* (depending on appliance model)	Hot soapy water: Clean with a dish cloth and dry with a soft cloth. On stainless steel surfaces, always wipe parallel to the natural grain. Otherwise, you may scratch the surface. Remove patches and splashes of limescale, grease, starch and albumin (e.g. egg white) immediately. Corrosion can form under such patches and splashes. Special care products suitable for hot stainless steel surfaces are available from our after-sales service and from specialist retailers. Apply a thin layer of care product with a soft cloth.
Enamel, painted, plastic and screen-printed surfaces* (depending on appliance model)	Hot soapy water: Clean with a dish cloth and dry with a soft cloth. Do not use glass cleaner or glass scrapers for cleaning.
Control panel	Hot soapy water: Clean with a dish cloth and dry with a soft cloth. Do not use glass cleaner or glass scrapers for cleaning.

* Optional (available for some appliances, depending on the appliance model)

Zone	Cleaning agent
Upper glass cover* (depending on appliance model)	Glass cleaner: Clean with a soft cloth. You can remove the upper glass cover for cleaning. To find out how to do this, please refer to the section <i>Upper glass cover</i> .
Rotary knobs Do not remove.	Hot soapy water: Clean with a dish cloth and dry with a soft cloth.
Hob surround	Hot soapy water: Do not clean with a glass scraper, lemon juice or vinegar.
Gas hob and pan supports* (depending on appliance model)	Hot soapy water. Use very little water. Water must not be allowed to enter the appliance through the base of the burners. Clean off boiled-over liquids and spilt food immediately. You can remove the pan supports. Cast iron pan supports*: Do not clean in the dishwasher.
Gas burners* (depending on appliance model)	Remove the burner head and cap and clean with hot soapy water. Do not clean in the dishwasher. The gas outlet openings must remain unobstructed at all times. Ignition plugs: Small, soft brush. The gas burners only work properly when the ignition plugs are dry. Dry all parts thoroughly. Ensure that they are refitted correctly. The burner caps are coated in black enamel. The colour may change over time. This does not impair their performance.
Electric hotplate* (depending on appliance model)	Abrasive materials or sponges: Briefly heat up the hotplate afterwards, so that it dries. Hotplates can rust over time if they remain wet. Apply care product to finish. Clean off boiled-over liquids and spilt food immediately.
Hotplate ring* (depending on appliance model)	Remove yellow to blue iridescent discoloration from the hotplate ring with a steel care product. Do not use any abrasive materials that may scratch surfaces.
Ceramic hob* (depending on appliance model)	Care: Protective/care products for ceramics Cleaning: Cleaning agents suitable for ceramics. Follow the cleaning instructions on the packaging. ⚠ Glass scraper for stubborn dirt: Remove the protective cover and clean using the blade only. Caution: The blade is very sharp. Risk of injury. Cover the blade again after cleaning. Replace damaged blades immediately.

* Optional (available for some appliances, depending on the appliance model)

Zone	Cleaning agent
Glass hob* (depending on appliance model)	Care: Protective/care products for glass Cleaning: Cleaning agents for glass. Follow the cleaning instructions on the packaging. ⚠ Glass scraper for stubborn dirt: Remove the protective cover and clean using the blade only. Caution: The blade is very sharp. Risk of injury. Cover the blade again after cleaning. Replace damaged blades immediately.
Glass panel	Glass cleaner: Clean with a soft cloth. Do not use the glass scraper. The door can be removed to facilitate cleaning. To find out how to do this, please refer to the section <i>Removing and refitting the oven door</i> .
Childproof lock* (depending on appliance model)	Hot soapy water: Clean with a dish cloth. If a childproof lock has been fitted to the oven door, it must be removed before cleaning. If it is very dirty, the childproof lock will not work properly.
Seal Do not remove.	Hot soapy water: Clean with a dish cloth. Do not scour.
Cooking zone	Hot soapy water or a vinegar solution: Clean with a dish cloth. For stubborn dirt, use a stainless steel scouring pad or oven cleaner. Only use when the cooking compartment is cold. ⚠ Please use the self-cleaning function to clean self-cleaning surfaces. To find out how to do this, please refer to the section <i>Self-cleaning</i> . Caution! Never use oven cleaner on self-cleaning surfaces.
Glass cover for the oven light	Hot soapy water: Clean with a dish cloth.
Shelf	Hot soapy water: Clean with a dish cloth or a brush. You can remove the shelves for cleaning. To find out how to do this, please refer to the section <i>Removing and refitting shelves</i> . Telescoping extension rails* (depending on appliance model) Hot soapy water: Clean with a dish cloth or a brush. Do not remove the lubricant from the extension rails. It is best to clean them when they are pushed in. Do not soak, clean in the dishwasher, or clean in the oven as part of the self-cleaning programme. This may damage the shelves and they may no longer work properly as a result.

* Optional (available for some appliances, depending on the appliance model)

Zone	Cleaning agent
Accessories	Hot soapy water: Soak and then clean with a dish cloth or a brush. Aluminium baking tray*: (depending on appliance model) Dry with a soft cloth. Do not clean in the dishwasher. Never use oven cleaner. To prevent scratches, never touch the metal surfaces with a knife or a similar sharp object. Harsh cleaning products, scratchy sponges and rough cleaning cloths are not suitable. Otherwise, you may scratch the surface. Rotary spit* (depending on appliance model) Hot soapy water: Clean with a dish cloth or a brush. Do not clean in the dishwasher. Meat thermometer* (depending on appliance model) Hot soapy water: Clean with a dish cloth or a brush. Do not clean in the dishwasher.
Plinth drawer* (depending on appliance model)	Hot soapy water: Clean with a dish cloth.

* Optional (available for some appliances, depending on the appliance model)

Upper glass cover

Before opening the top cover, remove any spills with a cloth.
Use glass cleaner if possible.

For cleaning, remove the top cover. To do this, hold the cover securely on both sides with both hands and pull it upwards.

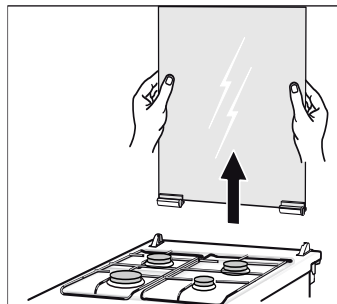

If the cover hinges become loose, note the letters marked on them. The hinge with the letter R must be fitted on the right, and the hinge with the letter L must be fitted on the left.

After cleaning, re-assemble the top cover following the same procedure in reverse order.

Only close the top cover once the burners have cooled down.

Caution!

When using appliances that have a glass cover with LED lighting

Do not use any of the following to clean the glass cover

- Undiluted cleaning agents
- Abrasive cleaners or cleaning agents with a high alcohol content
- Aggressive cleaning agents, such as oven cleaner or stain remover
- High-pressure cleaners or steam jet cleaners
- Harsh or scratchy cleaning agents
- Hard scouring pads or cleaning sponges

The LED lighting and the hinges of the glass cover on the hob must not come into contact with liquids.

Liquids will damage the printing, lighting and hinges on the glass cover and prevent the LED lighting from switching on.

Before cleaning

Remove accessories and cookware from the cooking compartment.

Cleaning the cooking compartment floor, ceiling and side walls

Use a dish cloth and hot soapy water or a vinegar solution.

If there are heavy deposits of dirt, use a stainless steel scouring pad or oven cleaner. Only use when the cooking compartment is cold. Never treat the self-cleaning surfaces with a scouring pad or oven cleaner.

Cleaning the self-cleaning surfaces in the cooking compartment

The back wall in the cooking compartment is coated with a highly porous ceramic layer. This coating absorbs and disintegrates splashes from baking and roasting while the oven is in operation. The higher the temperature and the longer the oven is in operation, the better the result will be.

If splashes are still visible even after repeated use, proceed as follows:

1. Clean the floor, ceiling and side panels of the cooking compartment thoroughly.
2. Set  3D hot air.
3. With the door closed, heat up the empty oven for approximately 2 hours at maximum temperature.

The ceramic coating is regenerated. When the cooking compartment has cooled down, remove the brown or white residue with water and a soft sponge.

Light discolouration of the coating does not affect automatic self-cleaning.

Caution!

- Never use abrasive cleaning agents. You will scratch or destroy the highly porous coating.
- Never treat the ceramic coating with oven cleaner. If oven cleaner accidentally gets onto it, remove it immediately with a sponge and plenty of water.

Detaching and refitting the rails

The rails can be removed for cleaning. The oven must have cooled down.

Detaching the rails

1. Lift up the front of the rail
2. and unhook it (figure A).
3. Then pull the whole rail forward
4. and remove it (Fig. B).

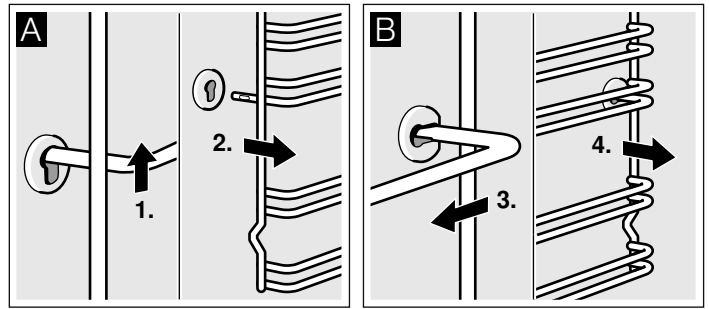

Clean the rails with cleaning agent and a sponge. For stubborn deposits of dirt, use a brush.

Refitting the rails

1. First insert the rail into the rear socket, press it to the back slightly (figure A),
2. and then hook it into the front socket (figure B).

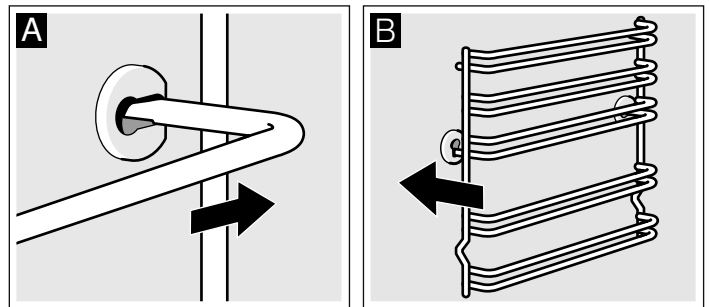

The rails fit both the left and right sides. Ensure that, as shown in figure B, levels 1 and 2 are below and levels 3, 4 and 5 are above.

Detaching and attaching the oven door

For cleaning purposes and to remove the door panels, you can detach the oven door.

The oven door hinges each have a locking lever. When the locking levers are closed (figure A), the oven door is secured in place. It cannot be detached. When the locking levers are open in order to detach the oven door (Fig. B), the hinges are locked. They cannot snap shut.

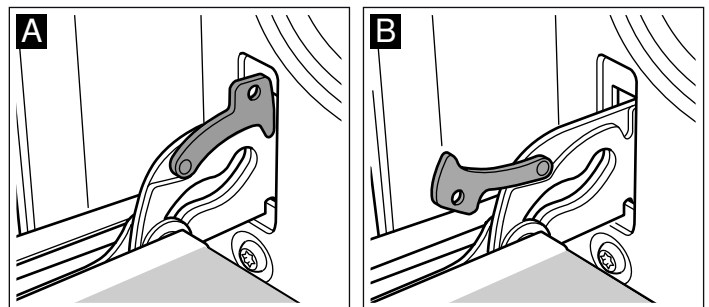

Risk of injury!

Whenever the hinges are not locked, they snap shut with great force. Ensure that the locking levers are always fully closed or, when detaching the oven door, fully open.

Detaching the door

1. Open the oven door fully.
2. Fold up the two locking levers on the left and right (figure A).
3. Close the oven door as far as the limit stop. With both hands, grip the door on the left and right-hand sides. Close the door a little further and pull it out (figure B).

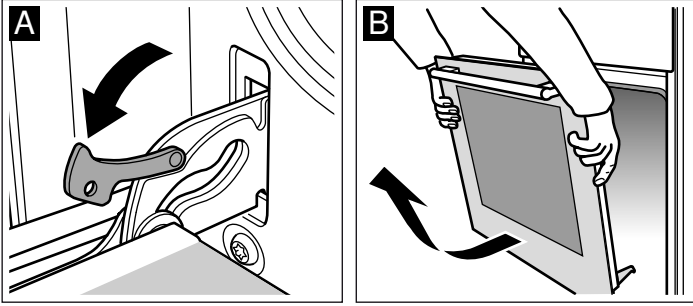

Attaching the door

Reattach the oven door in the reverse sequence to removal.

1. When attaching the oven door, ensure that both hinges are inserted straight into the opening (figure A).
2. The notch on the hinge must engage on both sides (figure B).

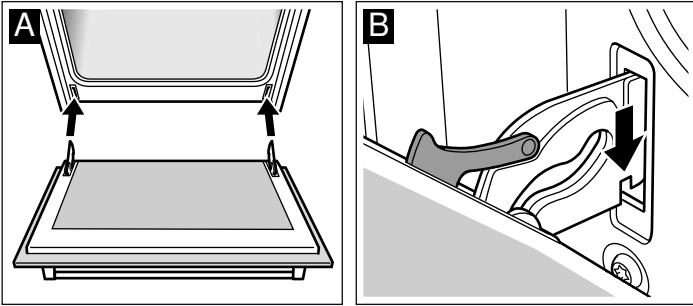

3. Fold back both locking levers (figure C). Close the oven door.

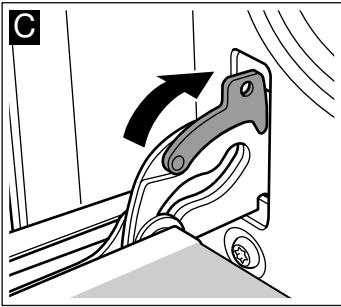

⚠ Risk of injury!

If the oven door falls out accidentally or a hinge snaps shut, do not reach into the hinge. Call the after-sales service.

Removing and installing the door panels

To facilitate cleaning, you can remove the glass panels from the oven door.

Removal

1. Detach the oven door and lay it on a cloth with the handle facing down.
2. Pull off the cover at the top of the oven door. Press in the tabs on the left and right using your fingers (fig. A).
3. Lift the top panel up and pull it out (fig. B).

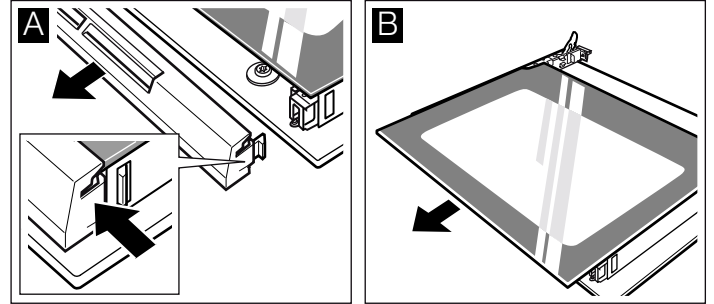

4. Lift the panel up and pull it out (fig. C).

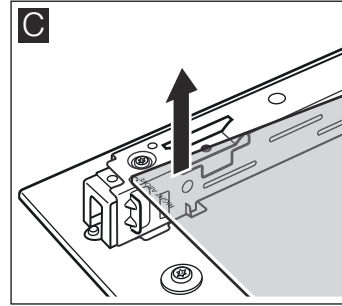

Clean the panels with glass cleaner and a soft cloth.

⚠ Risk of injury!

Scratched glass in the appliance door may develop into a crack. Do not use a glass scraper, sharp or abrasive cleaning aids or detergents.

Installation

During installation, make sure that the lettering "top right" is upside down at the bottom left.

1. Insert the panel at an angle towards the back (fig. A).
2. Insert the top panel at an angle towards the back into the brackets. The smooth surface must face outwards. (fig. B).

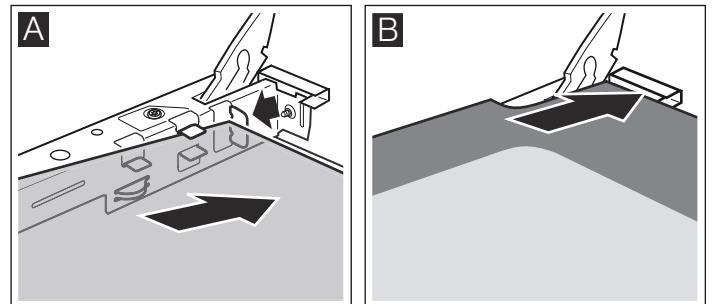

3. Put the cover back in place and press on it.
4. Attach the oven door.

Do not use the oven again until the panels have been correctly installed.

Troubleshooting

Malfunctions often have simple explanations. Refer to the table before calling the after-sales service as you may be able to remedy the fault yourself.

Fault table

If a dish does not turn out as well as you had hoped, please refer to the section *Tested for you in our cooking studio*. It contains useful tips and information on cooking, baking, roasting and frying.

⚠ Risk of electric shock!

Incorrect repairs are dangerous. Repairs must only be carried out by technicians that have been trained by our after-sales service.

Fault	Possible cause	Remedy/information
The oven is not working.	Faulty fuse.	Look in the household fuse box and check that the fuse is in working order.
	Power cut.	Check whether the kitchen light or other kitchen appliances are working.
The clock display is flashing.	Power cut.	Reset the time.
The oven is not heating up.	Dust on the contacts.	Turn the hotplate lever to the right and left a couple of times.
The gas burner will not ignite.	Power cut or damp spark plugs.	Light the gas burner with a gas lighter or a match.
The LED lighting on the glass cover is not working.	The LED lighting button has not been pressed.	Press the LED lighting button.
	The glass cover on the appliance is not fully open or is closed.	Open the glass cover on the appliance fully.
	The glass cover has not been fitted correctly.	Make sure that the hinges on the glass cover have been fitted correctly; see the "Glass cover" section.

Error messages

When the display panel shows an error message with **E**, press the **⊖** button. The message will disappear. The set time function will be deleted. If the error message does not disappear, call the Technical Assistance Service.

The following error messages can be solved by the user.

Error message	Possible cause	Solution/advice
E011	A button has been pressed for too long or has got stuck.	Press all of the buttons one by one. Check if any button is stuck, covered or dirty.

⚠ Risk of electric shock.!

Incorrect repairs can be dangerous. Repairs may only be carried out by qualified personnel from the Technical Assistance Service.

Replacing the bulb in the oven ceiling light

If the bulb in the oven light fails, it must be replaced. Heat-resistant, 40 watt spare bulbs can be obtained from our after-sales service or a specialist retailer. Only use these bulbs.

⚠ Risk of electric shock!

Switch off the circuit breaker in the fuse box.

1. Place a tea towel in the oven when it is cold to prevent damage.
2. Unscrew the glass cover by turning it anti-clockwise.

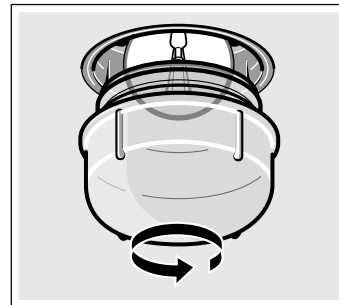

3. Replace the bulb with one of the same type.
4. Screw the glass cover back in.
5. Remove the tea towel and switch on the circuit breaker.

Glass cover

You must replace a damaged glass cover. Suitable glass covers may be obtained from the after-sales service. Please specify the E number and FD number of your appliance.

After-sales service

Our after-sales service is there for you if your appliance needs to be repaired. We will always find the right solution in order to avoid unnecessary visits from a service technician.

E number and FD number

When calling us, please give the product number (E no.) and the production number (FD no.) so that we can provide you with the correct advice. The rating plate containing these numbers is found on the side of the oven door. To save time, you can make a note of the number of your appliance and the telephone number of the after-sales service in the space below, should it be required.

E no.	FD no.
-------	--------

After-sales service

Please note that there will be a fee for a visit by a service technician in the event of a malfunction, even during the warranty period.

Please find the contact data of all countries in the enclosed customer service list.

To book an engineer visit and product advice

GB 0344 892 8979

Calls charged at local or mobile rate.

IE 01450 2655

0.03 € per minute at peak. Off peak 0.0088 € per minute.

Rely on the professionalism of the manufacturer. You can therefore be sure that the repair is carried out by trained service technicians who carry original spare parts for your appliances.

Energy and environment tips

Here you can find tips on how to save energy when baking and roasting in the oven and when cooking on the hob, and how to dispose of your appliance properly.

Saving energy with your oven

- Only preheat the oven if this is specified in the recipe or in the operating instruction tables.
- Use dark, black lacquered or enamelled baking tins. They absorb the heat particularly well.
- Open the oven door as infrequently as possible while cooking, baking or roasting.
- It is best to bake more than one cake, one after the other. The oven is still warm. This reduces the baking time for the second cake. You can also place two loaf tins next to each other.
- For longer cooking times, you can switch the oven off 10 minutes before the end of the cooking time and use the residual heat to finish cooking.

Saving energy with the gas hob

- Always use a saucepan which is the correct size for your food. A larger, less full saucepan requires a lot of energy.
- Always place a suitable lid on the saucepan.
- The gas flame must always be in contact with the base of the saucepan.

Environmentally-friendly disposal

Dispose of packaging in an environmentally-friendly manner.



This appliance is labelled in accordance with European Directive 2012/19/EU concerning used electrical and electronic appliances (waste electrical and electronic equipment - WEEE). The guideline determines the framework for the return and recycling of used appliances as applicable throughout the EU.

Tested for you in our cooking studio

Here you will find a selection of dishes and the ideal settings for them. We will show you which type of heating and which temperature are best suited for your dish. You can find information about suitable accessories and the height at which they should be inserted. There are also tips about cookware and preparation methods.

Notes

- The values in the table always apply to dishes placed into the cooking compartment when it is cold and empty.
Only preheat the appliance if the table specifies that you should do so. Do not line the accessories with greaseproof paper until after they have been preheated.
- The times specified in the tables are guidelines only. They will depend on the quality and composition of the food.
- Use the accessories supplied. Additional accessories may be obtained as special accessories from specialist retailers or from the after-sales service.
Before using the oven, remove any unnecessary accessories and ovenware from the cooking compartment.
- Always use oven gloves when taking hot accessories or ovenware out of the cooking compartment.

Cakes and pastries

Baking on one level

When baking cakes, the best results can be achieved using  Top/bottom heating.

When baking with  3D hot air, use the following shelf heights for the accessory:

- Cakes in tins: level 2
- Cakes on trays: level 3

Baking on two or more levels

Use  3D hot air.

Shelf heights for baking on 2 levels:

- Universal pan: level 3
- Baking tray: level 1

Shelf heights for baking on 3 levels:

- Baking tray: level 5

- Universal pan: level 3
- Baking tray: level 1

Baking trays that are placed in the oven at the same time will not necessarily be ready at the same time.

The tables show numerous suggestions for your dishes.

If you are baking with 3 cake/loaf tins at the same time, place these on the wire racks as indicated in the picture.

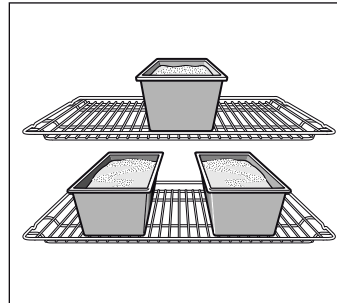

Baking tins

It is best to use dark-coloured metal baking tins.

Baking times are increased when light-coloured baking tins made of thin metal or glass dishes are used, and cakes do not brown so evenly.











If you wish to use silicone baking tins, use the information and recipes provided by the manufacturer as a guide. Silicone baking tins are often smaller than normal tins. The amount of mixture and recipe instructions may differ.

Tables

The tables show the ideal type of heating for the various cakes and pastries. The temperature and baking time depend on the amount and composition of the mixture. This is why temperature ranges are given in the tables. You should try the lower temperature first, since a lower temperature results in more even browning. You can increase the temperature next time if necessary.

If you preheat the oven, the baking time is shortened by 5 to 10 minutes.

Additional information can be found in the *Baking tips* section following the tables.

Cakes in tins	Tin	Level	Type of heating	Temperature in °C	Cooking time in minutes
Sponge cake, simple	Ring tin/loaf tin	2		160-180	40-50
	3 loaf tins	3+1		140-160	60-80
Sponge cake, delicate	Ring tin/loaf tin	2		150-170	60-70
Flan base, sponge	Flan-base cake tin	2		150-170	20-30
Delicate fruit flan, sponge	Springform/ring tin	2		160-180	50-60
Sponge flan	Springform cake tin	2		160-180	30-40
Shortcrust pastry base with crust	Springform cake tin	1		170-190	25-35
Fruit tart or cheesecake, pastry base*	Springform cake tin	1		170-190	70-90
Swiss flan	Pizza tray	1		220-240	35-45
Savoury cakes (e.g. quiche/onion tart)*	Springform cake tin	1		180-200	50-60
Pizza, thin base with light topping (pre-heat)	Pizza tray	1		250-270	10-15

* Turn off the oven and allow cakes to cool for an additional 20 minutes with the oven door closed.

Cakes on trays	Accessories	Level	Type of heating	Temperature in °C	Cooking time in minutes
Sponge mixture or yeast dough with dry topping	Baking tray	2	☐	170-190	20-30
	Universal pan + baking tray	3+1	☒	150-170	35-45
Sponge mixture or yeast dough with moist topping, fruit	Universal pan	3	☐	160-180	40-50
	Universal pan + baking tray	3+1	☒	150-170	50-60
Swiss flan	Universal pan	2	☐	210-230	40-50
Swiss roll (preheat)	Baking tray	2	☐	190-210	15-20
Plaited loaf with 500 g flour	Baking tray	2	☐	160-180	30-40
Stollen with 500 g flour	Baking tray	3	☐	160-180	60-70
Stollen with 1 kg flour	Baking tray	3	☐	150-170	90-100
Strudel, sweet	Universal pan	2	☐	180-200	55-65
Burek	Universal pan	2	☐	180-200	40-50
Pizza	Baking tray	2	☐	220-240	15-25
	Universal pan + baking tray	3+1	☒	180-200	35-45

Small baked products	Accessories	Level	Type of heating	Temperature in °C	Cooking time in minutes
Biscuits	Baking tray	3	☒	140-160	15-25
	Universal pan + baking tray	3+1	☒	130-150	25-35
	2 baking trays + universal pan	5+3+1	☒	130-150	30-40
Viennese whirls (preheat)	Baking tray	3	☐	140-150	30-40
	Baking tray	3	☒	140-150	30-40
	Universal pan + baking tray	3+1	☒	140-150	30-45
	2 baking trays + universal pan	5+3+1	☒	130-140	35-50
Macaroons	Baking tray	2	☐	110-130	30-40
	Universal pan + baking tray	3+1	☒	100-120	35-45
	2 baking trays + universal pan	5+3+1	☒	100-120	40-50
Meringue	Baking tray	3	☒	80-100	130-150
Choux pastry	Baking tray	2	☐	200-220	30-40
Puff pastry	Baking tray	3	☒	180-200	20-30
	Universal pan + baking tray	3+1	☒	180-200	25-35
	2 baking trays + universal pan	5+3+1	☒	160-180	35-45
Leavened cake	Baking tray	3	☐	180-200	20-30
	Universal pan + baking tray	3+1	☒	170-190	25-35

Bread and rolls



When baking bread, preheat the oven, unless instructions state otherwise.

Never pour water into the hot oven.

When baking on 2 levels, always insert the universal pan above the baking tray.

Bread and rolls	Accessories	Level	Type of heating	Temperature in °C	Cooking time in minutes
Yeast bread with 1.2 kg flour	Universal pan	2	☐	270	8
				200	35-45
Sourdough bread with 1.2 kg flour	Universal pan	2	☐	270	8
				200	40-50
Bread rolls (do not preheat)	Baking tray	3	☐	210-230	20-30
Rolls made with sweet yeast dough	Baking tray	3	☐	170-190	15-20
	Universal pan + baking tray	3+1	☒	160-180	20-30

Baking tips

You wish to bake according to your own recipe.	Use similar items in the baking tables as a guide.
How to establish whether sponge cake is baked through.	Approximately 10 minutes before the end of the baking time specified in the recipe, stick a cocktail stick into the cake at the highest point. If the cocktail stick comes out clean, the cake is ready.
The cake collapses.	Use less fluid next time or set the oven temperature 10 degrees lower. Observe the specified mixing times in the recipe.
The cake has risen in the middle but is lower around the edge.	Do not grease the sides of the springform cake tin. After baking, loosen the cake carefully with a knife.
The cake goes too dark on top.	Place it lower in the oven, select a lower temperature and bake the cake for a little longer.
The cake is too dry.	When it is done, make small holes in the cake using a cocktail stick. Then drizzle fruit juice or an alcoholic beverage over it. Next time, select a temperature 10 degrees higher and reduce the baking time.
The bread or cake (e.g. cheesecake) looks good, but is soggy on the inside (sticky, streaked with water).	Use slightly less fluid next time and bake for slightly longer at a lower temperature. For cakes with a moist topping, bake the base first. Sprinkle it with almonds or bread crumbs and then place the topping on top. Please follow the recipe and baking times.
The cake is unevenly browned.	Select a slightly lower temperature to ensure that the cake is baked more evenly. Bake delicate pastries on one level using  Top/bottom heating. Protruding greaseproof paper can affect the air circulation. For this reason, always cut greaseproof paper to fit the baking tray.
The bottom of a fruit cake is too light.	Place the cake one level lower the next time.
The fruit juice overflows.	Next time, use the deeper universal pan, if you have one.
Small baked items made out of yeast dough stick to one another when baking.	There should be a gap of approx. 2 cm around each item. This gives enough space for the baked items to expand well and turn brown on all sides.
You were baking on several levels. The items on the top baking tray are darker than that on the bottom baking tray.	Always use  3D hot air to bake on more than one level. Baking trays that are placed in the oven at the same time will not necessarily be ready at the same time.
Condensation forms when you bake moist cakes.	Baking may result in the formation of water vapour, which escapes above the door. The steam may settle and form water droplets on the control panel or on the fronts of adjacent units. This is a natural process.

Meat, poultry, fish

Ovenware

You may use any heat-resistant ovenware. The universal pan is suitable for large roasts.

Glass ovenware is the most suitable. Ensure that the lid of the roasting dish fits well and closes properly.

Add a little more liquid when using enamelled roasting dishes.

With roasting dishes made of stainless steel, browning is not so intense and the meat may be somewhat less well cooked.

Increase the cooking times.

Information in the tables:

Ovenware without a lid = open

Ovenware with a lid = closed

Always place the ovenware in the centre of the wire rack.

Place hot glass ovenware on a dry mat after cooking. The glass could crack if placed on a cold or wet surface.

Roasting

Add in a little liquid if the meat is lean. Cover the base of the ovenware with approx. ½ cm of liquid.

Add liquid generously for pot roasts. Cover the base of the ovenware with approx. 1 - 2 cm of liquid.

The amount of liquid depends on the type of meat and the material the ovenware is made of. If preparing meat in an enamelled roasting dish, it will need a little more liquid than if cooked in glass ovenware.

Roasting dishes made from stainless steel are not ideal. The meat cooks more slowly and browns less fully. Use a higher temperature and/or a longer cooking time.

Grilling

When grilling, preheat the oven for approx. 3 minutes, before placing the food into the cooking compartment.

Always grill with the oven door closed.

As far as possible, the pieces of food you are grilling should be of equal thickness. This will allow them to brown evenly and remain succulent and juicy.

Turn the food you are grilling after ⅔ of the time.

Do not add salt to steaks until they have been grilled.

Place the food to be grilled directly on the wire rack. If you are grilling a single piece, the best results are achieved by placing it in the centre of the wire rack.

The universal pan should also be inserted at level 1. The meat juices are collected in the pan and the oven is kept cleaner.

When grilling, do not insert the baking tray or universal pan at level 4 or 5. The high heat distorts it and the cooking compartment can be damaged when removing it.

The grill element switches on and off continually. This is normal. The grill setting determines how frequently this will happen.

Meat

Turn pieces of meat halfway through the cooking time.

When the roast is ready, turn off the oven and allow it to rest for an additional 10 minutes. This allows better distribution of the meat juices.

After cooking, wrap sirloin in aluminium foil and leave it to rest for 10 minutes in the oven.

For roast pork with a rind, score the rind in a crossways pattern, then lay the roast in the dish with the rind at the bottom.

Meat	Weight	Accessories and ovenware	Level	Type of heating	Temperature in °C, grill setting	Cooking time in minutes
Beef						
Pot-roasted beef	1.0 kg	Covered	2		200-220	120
	1.5 kg		2		190-210	140
	2.0 kg		2		180-200	160
Fillet of beef, medium	1.0 kg	Uncovered	2		210-230	70
	1.5 kg		2		200-220	80
Sirloin, medium	1.0 kg	Uncovered	1		210-230	50
Steaks, medium, 3 cm thick		Wire rack	5		3	15
Veal						
Joint of veal	1.0 kg	Uncovered	2		190-210	100
	2.0 kg		2		170-190	120
Pork						
Joint without rind (e.g. neck)	1.0 kg	Uncovered	1		200-220	100
	1.5 kg		1		190-210	140
	2.0 kg		1		180-200	160
Joint with rind (e.g. shoulder)	1.0 kg	Uncovered	1		200-220	120
	1.5 kg		1		190-210	150
	2.0 kg		1		180-200	180
Smoked pork on the bone	1.0 kg	Covered	2		210-230	70
Lamb						
Leg of lamb, boned, medium	1.5 kg	Uncovered	1		150-170	120
Minced meat						
Meat loaf	Made from 500 g meat	Uncovered	1		170-190	70
Sausages						
Sausages		Wire rack	4		3	15

Poultry

The weights indicated in the table refer to oven-ready poultry (without stuffing).

Place whole poultry on the lower wire rack breast-side down. Turn after $\frac{2}{3}$ of the specified time.

Turn roasts, such as rolled turkey joint or turkey breast, halfway through the cooking time. Turn poultry portions after $\frac{2}{3}$ of the time.

For duck or goose, pierce the skin on the underside of the wings. This allows the fat to run out.

Poultry will turn out particularly crispy and brown if you baste it towards the end of the roasting time with butter, salted water or orange juice.

Poultry	Weight	Accessories and ovenware	Level	Type of heating	Temperature in °C	Cooking time in minutes
Chicken, whole	1.2 kg	Wire rack	2		200-220	60-70
Poulard, whole	1.6 kg	Wire rack	2		190-210	80-90
Chicken, halved	500 g each	Wire rack	2		200-220	40-50
Chicken portions	300 g each	Wire rack	3		200-220	30-40
Duck, whole	2.0 kg	Wire rack	2		170-190	90-100
Goose, whole	3.5-4.0 kg	Wire rack	2		160-170	110-130
Small turkey, whole	3.0 kg	Wire rack	2		170-190	80-100
Turkey thigh	1.0 kg	Wire rack	2		180-200	90-100





Fish

Turn the pieces of fish after $\frac{2}{3}$ of the time.

Whole fish does not have to be turned. Place the whole fish in the oven in its swimming position with its dorsal fin facing

upwards. Placing half a potato or a small ovenproof container in the belly of the fish will make it more stable.

If you are grilling directly on the wire rack, the universal pan should also be inserted at level 1. The liquid is then collected, thereby keeping the oven cleaner.

Fish	Weight	Accessories and ovenware	Level	Type of heating	Temperature in °C, grill setting	Cooking time in minutes
Fish, whole	300 g each (approx.)	Wire rack	2		3	20-25
	1.0 kg	Wire rack	2		180-200	45-50
	1.5 kg	Wire rack	2		170-190	50-60
Fish steak, 3 cm thick		Wire rack	3		2	20-25

Tips for roasting and grilling







The table does not contain information for the weight of the joint.	Select the next lowest weight from the instructions and extend the time.
How to tell when the roast is ready.	Use a meat thermometer (available from specialist shops) or carry out a "spoon test". Press down on the roast with a spoon. If it feels firm, it is ready. If the spoon can be pressed in, it needs to be cooked for a little longer.
The roast is too dark and the crackling is partly burnt.	Check the shelf height and temperature.
The roast looks good but the juices are burnt.	Next time, use a smaller roasting dish or add more liquid.
The roast looks good but the juices are too clear and watery.	Next time, use a larger roasting dish and use less liquid.
Steam rises from the roast when basted.	This is normal and due to the laws of physics. The majority of the steam escapes through the steam outlet. It may settle and form condensation on the cooler switch panel or on the fronts of adjacent units.

Bakes, gratins, toast with toppings

If you are grilling directly on the wire rack, the universal pan should also be inserted at level 1. This keeps the oven cleaner.

Always place the ovenware on the wire rack.

How well cooked the bake is will depend on the size of the dish and the height of the bake. The figures in the table are only average values.

















Dish	Accessories and ovenware	Level	Type of heating	Temperature in °C	Cooking time in minutes
Bakes					
Bake, sweet	Ovenproof dish	2		180-200	40-50
Pasta bake	Ovenproof dish	2		210-230	30-40
Gratin					
Potato gratin, raw ingredients, max. 4 cm deep	1 ovenproof dish	2		160-180	60-80
	2 ovenproof dishes	1+3		150-170	65-85
Toast					
Toast with topping, 4 slices	Wire rack	4		160-170	10-15
Toast with topping, 12 slices	Wire rack	4		160-170	15-20

Preprepared products

Observe the instructions on the packaging.

If you line the accessories with greaseproof paper, make sure that the paper is suitable for these temperatures. Make sure the paper is a suitable size for the dish to be cooked.

The cooking result greatly depends on the quality of the food. Pre-browning and irregularities can sometimes even be found on the raw product.

Dish	Accessories	Level	Type of heating	Temperature in °C, grill setting	Cooking time in minutes
Pizza, frozen					
Pizza with thin base	Universal pan	2		190-210	15-20
	Universal pan + wire rack	3+1		180-200	20-30
Pizza with deep-pan base	Universal pan	2		170-190	20-30
	Universal pan + wire rack	3+1		170-190	25-35
Pizza baguette	Universal pan	3		170-190	20-30
Mini pizza	Universal pan	3		180-200	10-20
Pizza, chilled, preheat	Universal pan	1		180-200	10-15
Potato products, frozen					
Chips	Universal pan	3		190-210	20-30
	Universal pan + baking tray	3+1		180-200	30-40
Croquettes	Universal pan	3		190-210	20-25
Rösti, stuffed potato pockets	Universal pan	3		190-210	15-25
Baked items, frozen					
Bread rolls, baguette	Universal pan	3		190-210	10-20
Pretzels (dough)	Universal pan	3		200-220	10-20
Baked items, prebaked					
Part-cooked rolls or part-cooked baguette	Universal pan	3		190-210	10-20
	Universal pan + wire rack	3+1		160-180	20-25
Processed portions, frozen					
Fish fingers	Universal pan	2		200-220	10-15
Chicken goujons, nuggets	Universal pan	3		190-210	10-20
Strudel, frozen					
Strudel	Universal pan	3		190-210	30-40



Special dishes

At low temperatures,  3D hot air is equally useful for producing creamy yoghurt as it is for proving light yeast dough.

First, remove accessories, hook-in racks or telescopic shelves from the cooking compartment.

Preparing yoghurt

1. Bring 1 litre of milk (3.5 % fat) to the boil and cool down to 40 °C.
2. Stir in 150 g of yoghurt (at refrigerator temperature).
3. Pour into cups or small screw-top jars and cover with cling film.

Dish	Ovenware		Type of heating	Temperature	Cooking time
Yoghurt	Cups or screw-top jars	on the cooking compartment floor		50 °C Preheat	5 mins
				50 °C	8 hrs
Proving dough	Heat-resistant dish	on the cooking compartment floor		50 °C Preheat	5-10 mins
				Switch off the appliance and place the yeast dough in the cooking compartment	20-30 mins

Defrosting

Take food out of its packaging and place in suitable ovenware on the wire rack.

Observe the instructions on the packaging.

The defrosting time depends on the amount and type of food.

Place poultry with the breast side to the plate.

Frozen food

e.g. cream cakes, buttercream cakes, gateaux with chocolate or sugar icing, fruit, chicken, sausage and meat, bread and bread rolls, cakes and other baked items

Accessories	Level	Type of heating	Temperature in °C
Wire rack	2		The temperature selector remains switched off

Drying

With  3D hot air, you can dry foods brilliantly.





Use unblemished fruit and vegetables only and wash them thoroughly.

Drain off the excess water, then dry them.

Line the universal pan and the wire rack with greaseproof or parchment paper.

Turn very juicy fruit or vegetables several times.

Remove fruit and vegetables from the paper as soon as they have dried.

Fruit and herbs	Accessories	Level	Type of heating	Temperature	Cooking time
600 g apple rings	Universal pan + rack	3+1		80 °C	5 hrs (approx.)
800 g pear slices	Universal pan + rack	3+1		80 °C	8 hrs (approx.)
1.5 kg damsons or plums	Universal pan + rack	3+1		80 °C	8-10 hrs (approx.)
200 g herbs, washed	Universal pan + rack	3+1		80 °C	1½ hrs (approx.)

Preserving

For preserving, the jars and rubber seals must be clean and intact. If possible, use jars of the same size. The information in the table is for round, one-litre jars.

Caution!

Do not use jars that are larger or taller than this. The lids could crack.

Only use fruit and vegetables in good condition. Wash them thoroughly.

The times given in the tables are a guide only. The time will depend on the room temperature, number of jars, and the quantity and temperature of the contents. Before you switch off the appliance or change the cooking mode, check whether the contents of the jars are bubbling as they should.

Preparation

1. Fill the jars, but not to the top.
2. Wipe the rims of the jars, as they must be clean.
3. Place a damp rubber seal and a lid on each jar.

Fruit in one-litre jars

Fruit in one-litre jars	When it starts to bubble	Residual heat
Apples, redcurrants, strawberries	Switch off	approx. 25 minutes
Cherries, apricots, peaches, gooseberries	Switch off	approx. 30 minutes
Apple purée, pears, plums	Switch off	approx. 35 minutes

Vegetables

As soon as bubbles begin to form in the jars, set the temperature back to between 120 and 140 °C. Depending on

4. Seal the jars with the clips.

Place no more than six jars in the cooking compartment.

Making settings

1. Insert the universal pan at level 2. Arrange the jars on it so that they do not touch each other.
2. Pour ½ litre of hot water (approx. 80 °C) into the universal pan.
3. Close the oven door.
4. Set Bottom heating.
5. Set the temperature to between 170 and 180 °C.

Preserving

Fruit

After approx. 40 to 50 minutes, small bubbles begin to form at short intervals. Switch off the oven.

After 25 to 35 minutes of residual heat, remove the preserving jars from the cooking compartment. If they are allowed to cool for longer in the cooking compartment, germs could multiply, promoting acidification of the preserved fruit.

the type of vegetable, heat for approx. 35 to 70 minutes. Switch off the oven after this time and use the residual heat.

Vegetables with cold cooking water in one-litre jars

Vegetables with cold cooking water in one-litre jars	When it starts to bubble	Residual heat
Gherkins	-	approx. 35 minutes
Beetroot	approx. 35 minutes	approx. 30 minutes
Brussels sprouts	approx. 45 minutes	approx. 30 minutes
Beans, kohlrabi, red cabbage	approx. 60 minutes	approx. 30 minutes
Peas	approx. 70 minutes	approx. 30 minutes

Taking out the jars

After preserving, remove the jars from the cooking compartment.

Caution!

Do not place the hot jars on a cold or wet surface. They could suddenly burst.

Acrylamide in foodstuffs

Acrylamide is mainly produced in grain and potato products prepared at high temperatures, such as potato crisps, chips,

toast, bread rolls, bread or fine baked goods (biscuits, gingerbread, cookies).

Tips for keeping acrylamide to a minimum when preparing food

General	
	<ul style="list-style-type: none">■ Keep cooking times to a minimum.■ Cook meals until they are golden brown, but not too dark.■ Large, thick pieces of food contain less acrylamide.
Baking	With top/bottom heating max. 200 °C. With 3D hot air or hot air max. 180 °C.
Biscuits	With top/bottom heating max. 190 °C. With 3D hot air or hot air max. 170 °C. Egg or egg yolk reduces the production of acrylamide.
Oven chips	Spread evenly over the baking tray, in a single layer. Bake at least 400 g per baking tray so that the chips do not dry out

Test dishes

These tables have been produced for test institutes to facilitate the inspection and testing of the various appliances.

In accordance with EN 50304/EN 60350 (2009) and IEC 60350.

Baking

Baking on 2 levels:

Always insert the universal pan above the baking tray.

Baking on 3 levels:

Insert the universal pan in the middle.

Piped biscuits:

Baking trays that are placed in the oven at the same time will not necessarily be ready at the same time.

Double crust apple pie on 1 level:

place dark springform cake tins next to each other diagonally on the same level.

Double crust apple pie on 2 levels:

Place dark springform cake tins next to each other (see illustration).

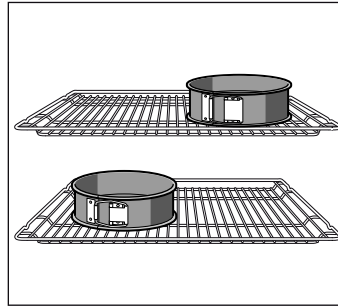

Cakes in tinplate springform cake tins:

Bake on 1 level with ☐ Top/bottom heating. Place the springform cake tin on the universal pan instead of on the wire rack.

Note: For baking, use the lower of the temperatures indicated first.

Dish	Accessories and oven-ware	Level	Type of heating	Temperature in °C	Cooking time in minutes
Whirls , preheat*	Baking tray	3	☐	140-150	30-40
	Baking tray	3	⊗	140-150	30-40
	Baking tray + universal pan	1+3	⊗	140-150	30-45
	2 baking trays + universal pan	1+3+5	⊗	130-140	40-55
Small cakes, preheat*	Baking tray	3	☐	150-170	20-35
	Baking tray	3	⊗	150-170	20-35
	Baking tray + universal pan	1+3	⊗	140-160	30-45
	2 baking trays + universal pan	1+3+5	⊗	130-150	35-55
Hot water sponge cake, preheat*	Springform cake tin on the wire rack	2	☐	160-170	30-40
	Springform cake tin on the wire rack	2	⊗	160-170	25-40
Apple pie	Wire rack + 2 springform cake tins, dia. 20 cm	1	☐	170-190	80-100
	2 wire racks + 2 springform cake tins, dia. 20 cm	1+3	⊗	170-190	70-100

* Do not use rapid heating to preheat the appliance.

Grilling

If you are grilling food directly on the wire rack, the universal pan should also be inserted at level 1. The liquid is then collected, keeping the oven cleaner.

Dish	Accessories and oven-ware	Level	Type of heating	Grill setting	Cooking time in minutes
Toast Preheat for 10 minutes	Wire rack	5	☐	3	1/2-2
Beefburgers, x 12* do not preheat	Wire rack + universal pan	4+1	☐	3	25-30

* turn over after 2/3 of the cooking time.



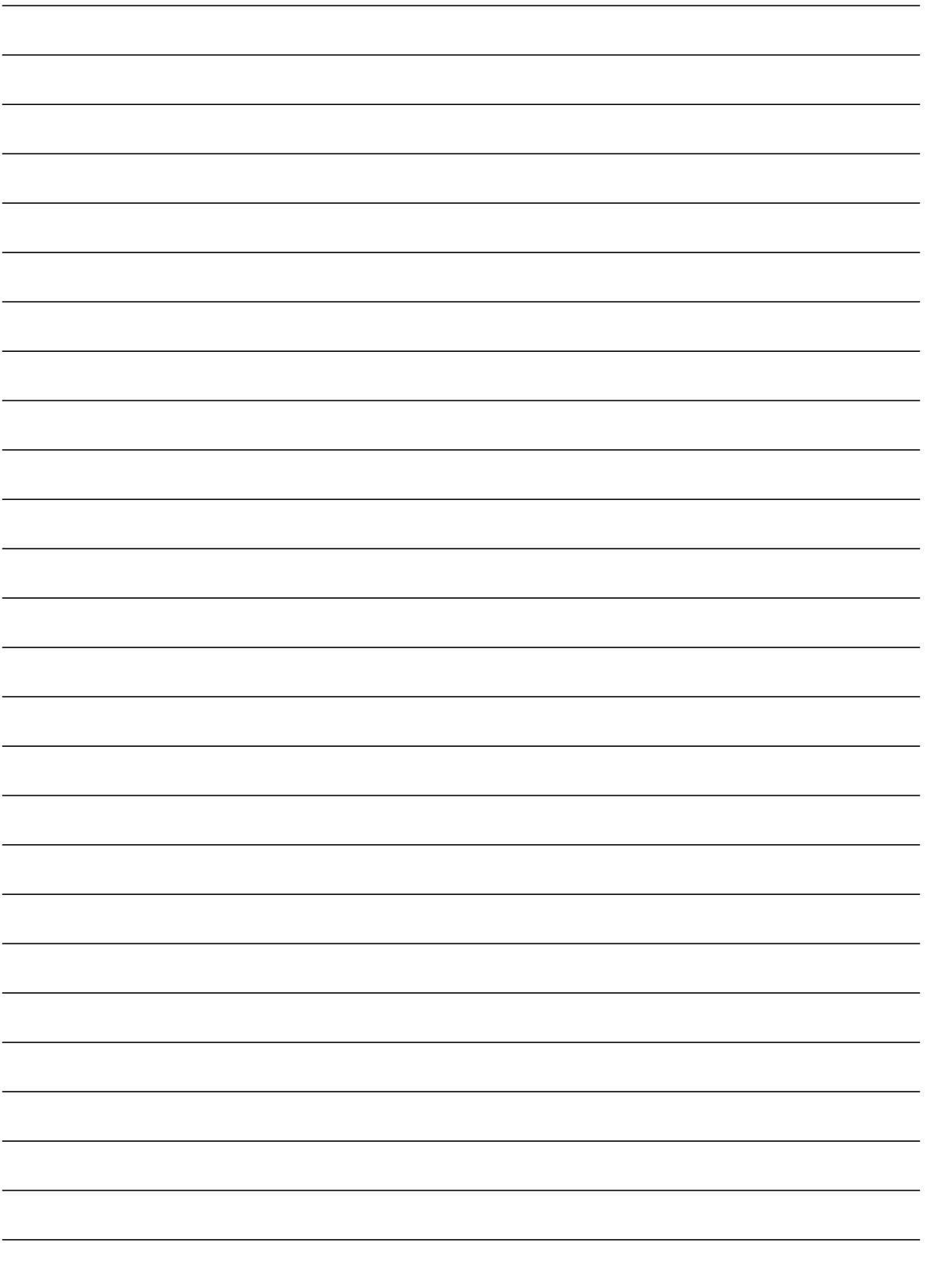





Robert Bosch Hausgeräte GmbH

Carl-Wery-Straße 34

81739 München

Germany

www.bosch-home.com



9001174841

01
291295