

<b>de</b> Montageanleitung	<b>ru</b> Инструкция по монтажу	<b>bs</b> Uputa za montažu
<b>en</b> Installation instructions	<b>cs</b> Montážní návod	<b>fa</b> راهنمایی مونتاژ
<b>fr</b> Notice de montage	<b>pl</b> Instrukcja montażu	<b>ar</b> تعليمات التركيب
<b>nl</b> Montagevoorschrift	<b>hu</b> Szerelési utasítás	<b>ko</b> 설치 설명서
<b>it</b> Istruzioni per il montaggio	<b>hr</b> Uputa za montažu	<b>zh</b> 安装说明
<b>el</b> Οδηγίες τοποθέτησης	<b>mk</b> Упатство за монтажа	<b>uk</b> Інструкція з монтажу
<b>es</b> Instrucciones de montaje	<b>sl</b> Navodilo za montažo	<b>ro</b> Instrucțiunea de montaj
<b>pt</b> Instruções de montagem	<b>sr</b> Uputstvo za montažu	<b>bg</b> Упътване за монтаж
<b>sv</b> Monteringsanvisning	<b>et</b> Monteerimisjuhend	<b>ja</b> インストールに関する指示
<b>no</b> Monteringsanvisning	<b>lt</b> Montavimo instrukcija	<b>he</b> הוראות התקנה
<b>fi</b> Asennusohje	<b>lv</b> Montāžas pamācība	<b>id</b> Instruksi Pemasangan
<b>da</b> Monteringsvejledning	<b>sk</b> Návod na montáž	<b>kk</b> Іске қосу туралы нұсқаулар
<b>tr</b> Montaj kılavuzu	<b>sq</b> Udhëzues për montim	

<b>de</b> *) über Kundendienst erhältlich	<b>sl</b> *) Lahko nabavite v servisni službi
<b>en</b> *) Available from customer service	<b>sr</b> *) Može se nabaviti preko servisne službe
<b>fr</b> *) Disponible par le biais du service après-vente	<b>et</b> *) küsige klienditeeninduselt
<b>nl</b> *) Tegen meerprijs bij de Servicedienst verkrijgbaar	<b>lt</b> *) Ją galima gauti klientų aptarnavimo servise
<b>it</b> *) Disponibili presso il servizio assistenza clienti	<b>lv</b> *) Var saņemt servisa dienestā
<b>el</b> *) Διατίθενται από την υπηρεσία τεχνικής εξυπηρέτησης πελατών	<b>sk</b> *) Dostanete v službe zákazníkom
<b>es</b> *) Se puede adquirir a través del Servicio de Asistencia Técnica Oficial de la marca	<b>sq</b> *) Sigurohet nëpërmjet servisit
<b>pt</b> *) Pode ser adquirido nos nossos Serviços Técnicos	<b>bs</b> *) Može se dobiti preko servisne službe
<b>sv</b> *) kan fås via Service	<b>fa</b> *) از مرکز خدمات پس از فروش تهیه فرمائید
<b>no</b> *) fåes hos kundeservice	<b>ar</b> *) يمكن طلبها من مراكز خدمة العملاء
<b>fi</b> *) Saatavissa huoltopalvelusta	<b>ko</b> *) 고객센터 서비스 센터에서 구입 가능
<b>da</b> *) Kan købes hos serviceafdelingen	<b>zh</b> *) 可通过售后服务部门购得
<b>tr</b> *) Yetkili servis üzerinden alınabilir	<b>uk</b> *) Можна отримати через сервісну службу
<b>ru</b> *) Можно получить в сервисном центре	<b>ro</b> *) Se obține de la serviciul pentru clienți
<b>cs</b> *) K dispozici přes servisní službu	<b>bg</b> *) може да се намери в специализираните сервиси
<b>pl</b> *) Do uzyskania w punkcie serwisowym	<b>ja</b> *) 顧客サービスから利用可能
<b>hu</b> *) A vevőszolgálaton keresztül kapható	<b>he</b> *) להשיג בתחנת שירות הלקוחות
<b>hr</b> *) može dobiti kod službe održavanja	<b>id</b> *) bisa didapatkan melalui Customer Service
<b>mk</b> *) се добива преку службата за купувачи	<b>kk</b> *) Сервис қызмет көрсету орталығында алуына жатады

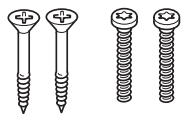

Ø4X36 Ø4X30



Ø4X15

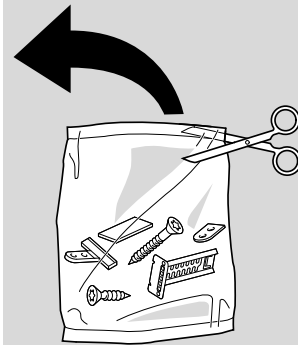
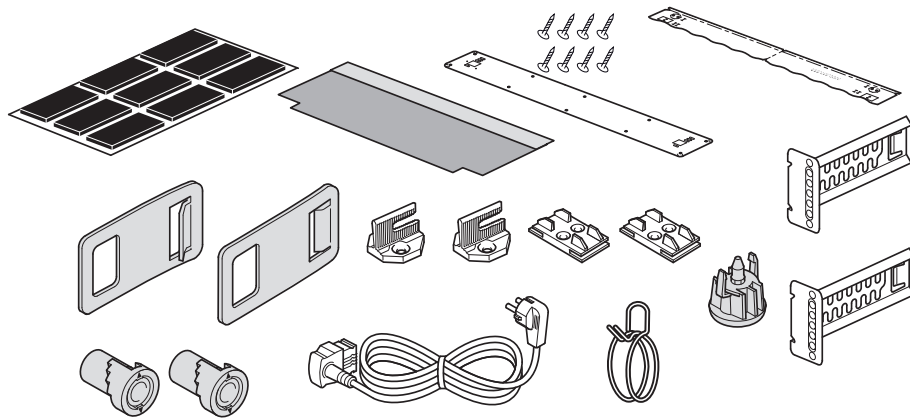
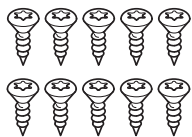

Torx T 20 Torx T 15

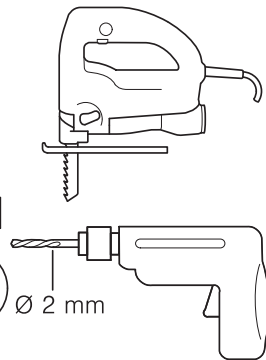
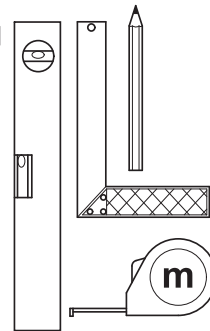
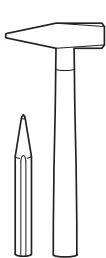
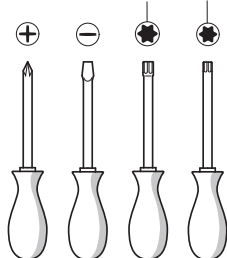

SW13

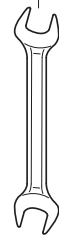

SW10

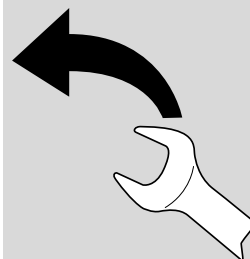
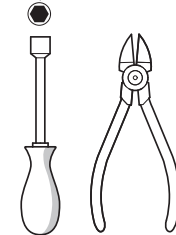

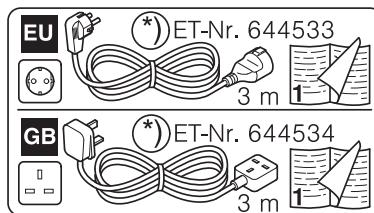
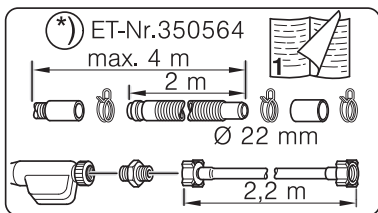
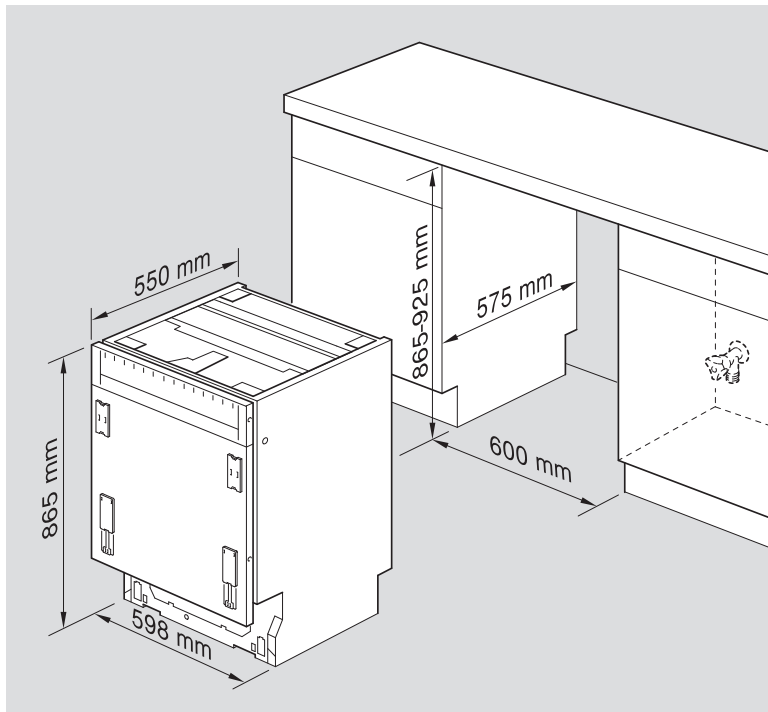
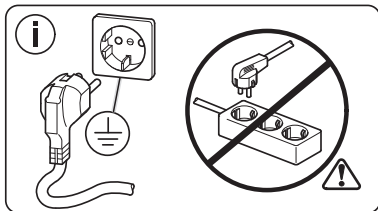
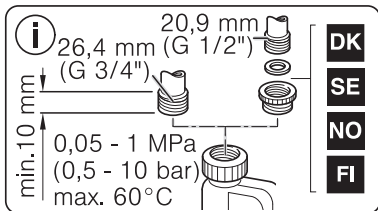
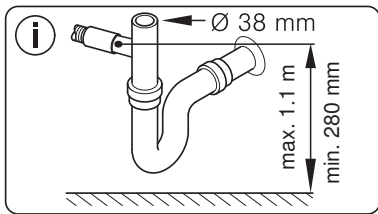

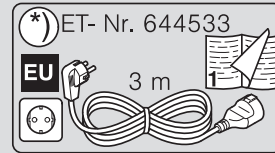
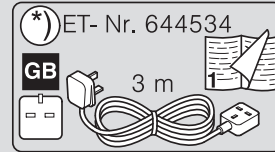
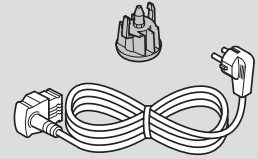
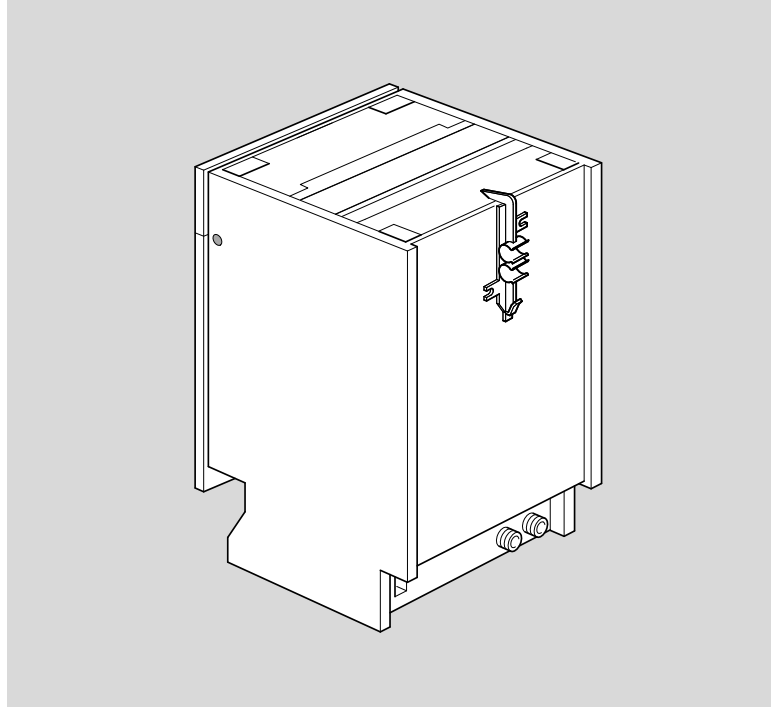
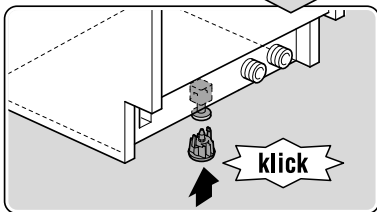
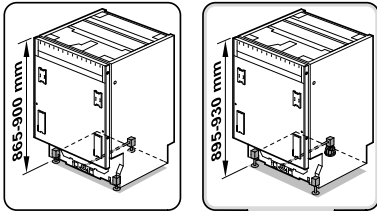
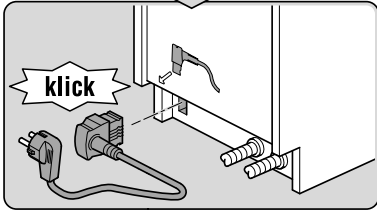
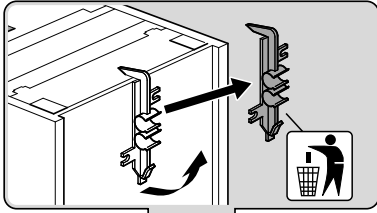

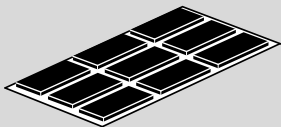
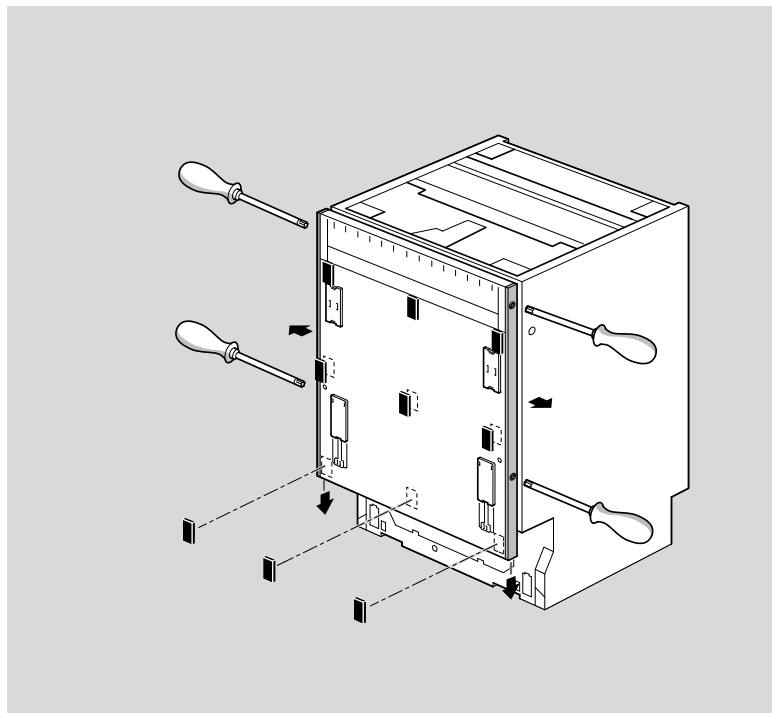
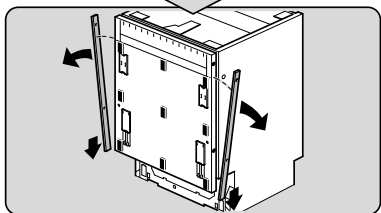
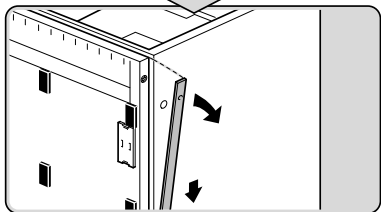
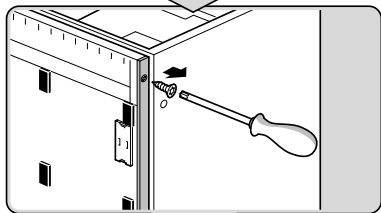
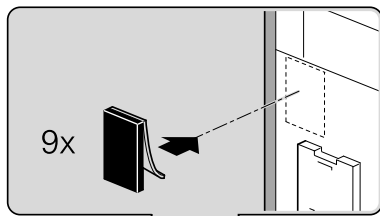

Torx  
T 15



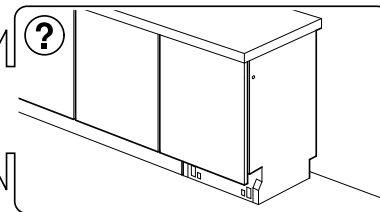
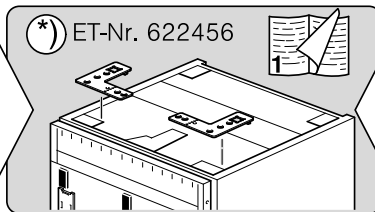
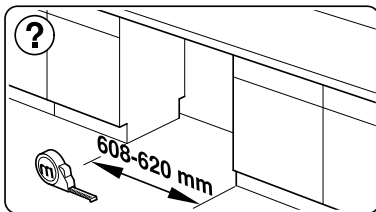
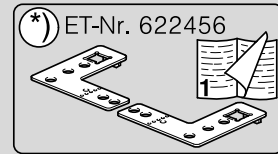
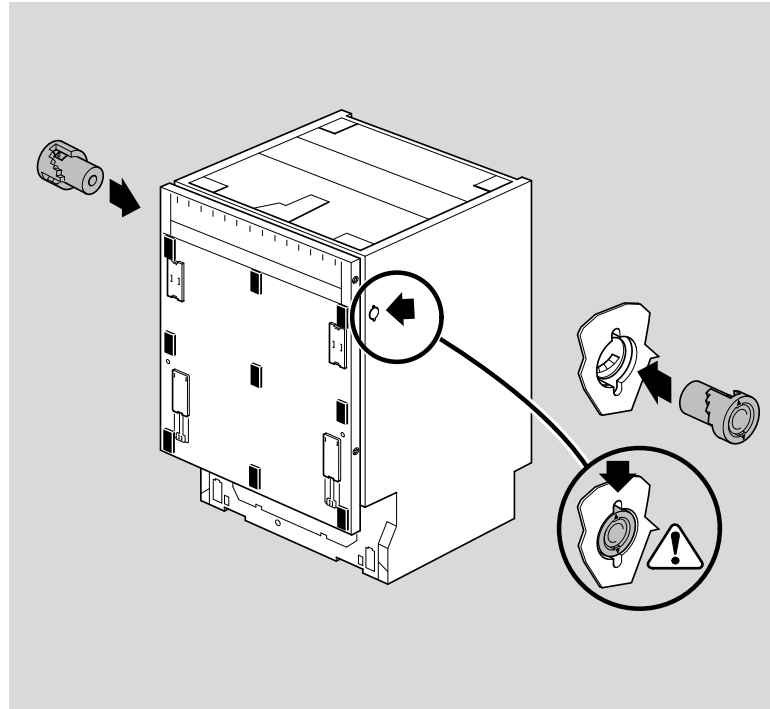
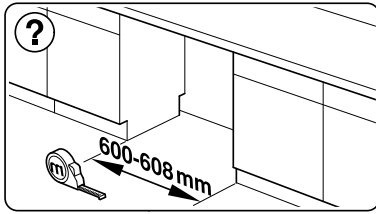

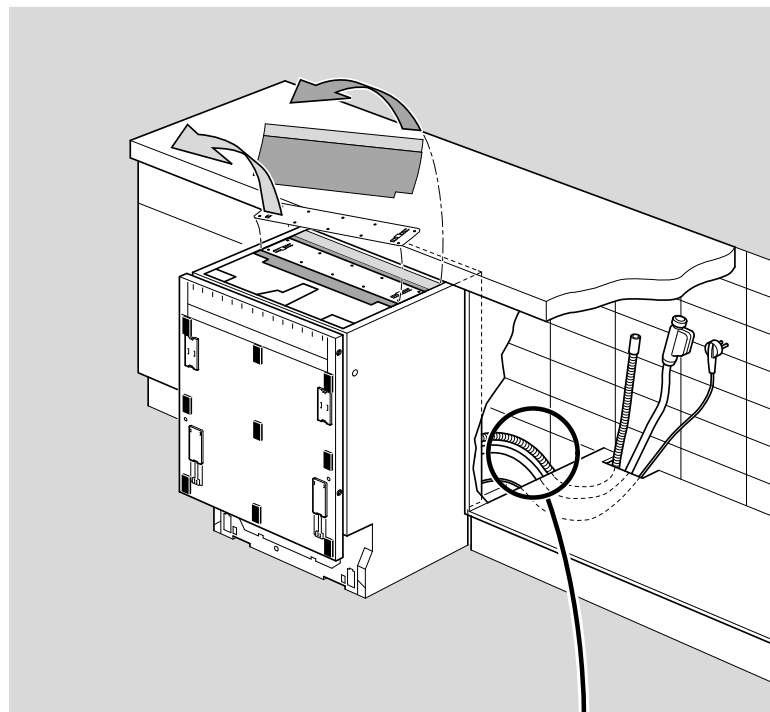
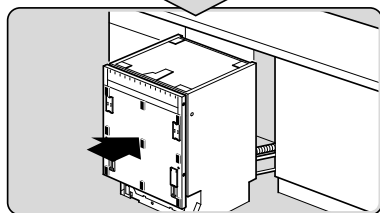
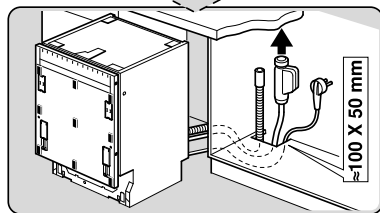
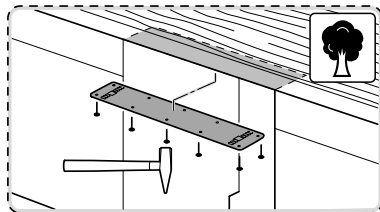
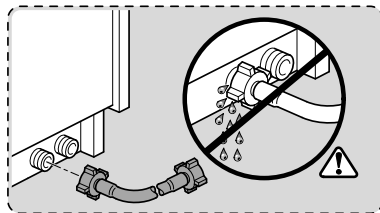

**nicht einklemmen**  
**do not pinch**  
**ne pas coincer**  
**No doblar**

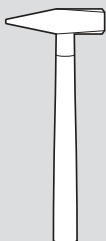
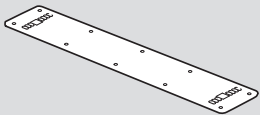
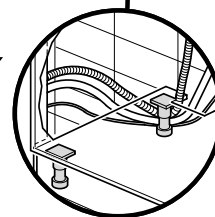

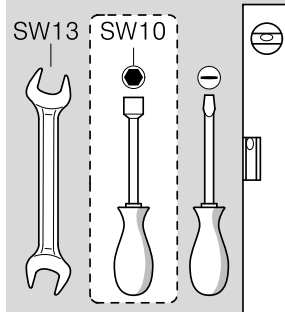
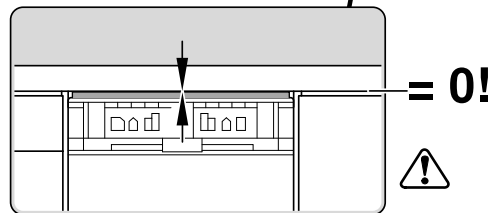
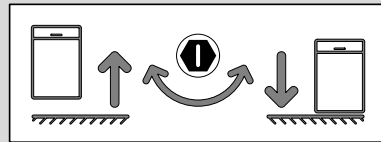
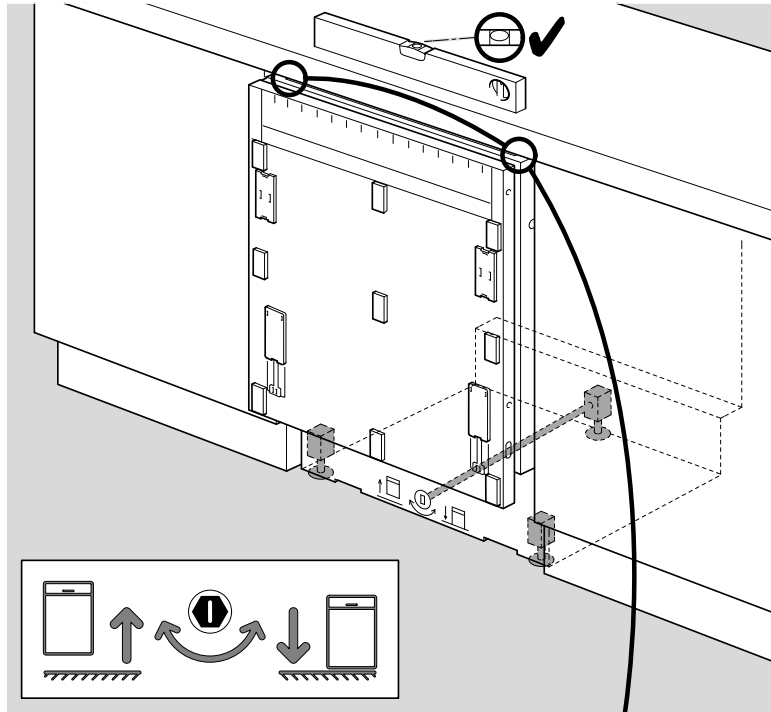
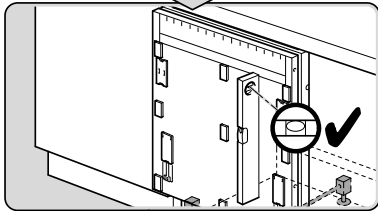
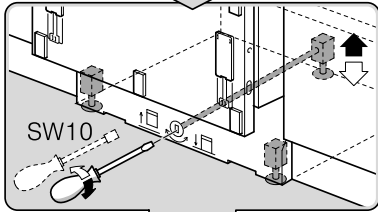
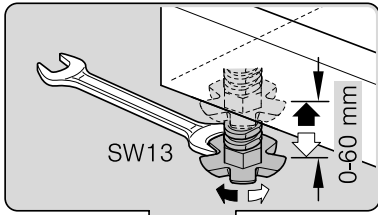



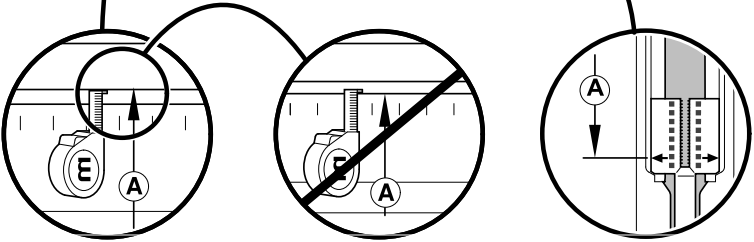
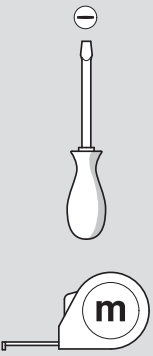
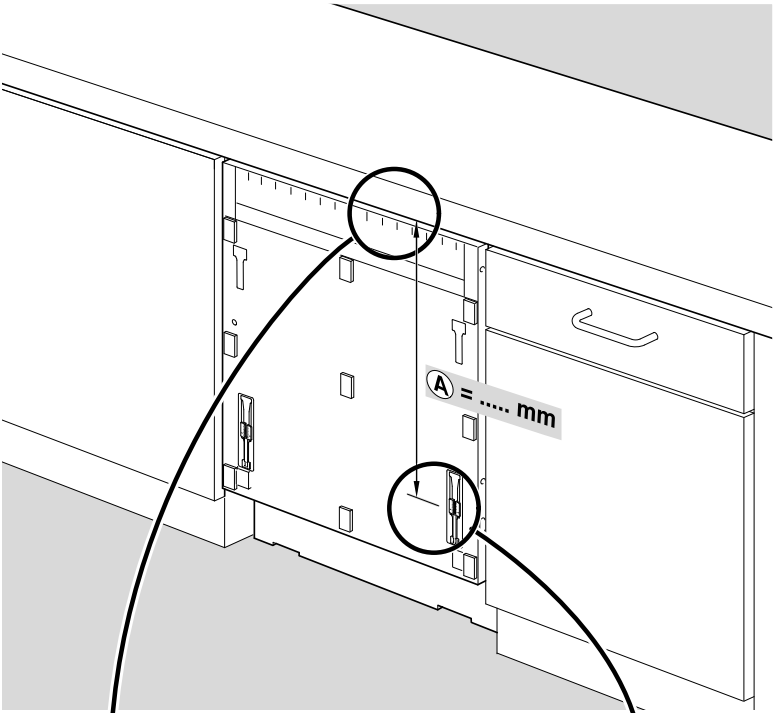
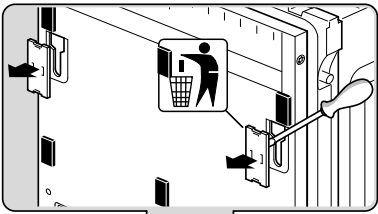

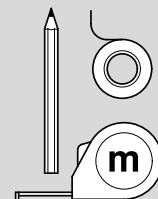
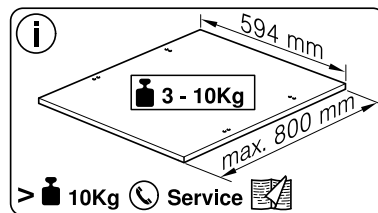
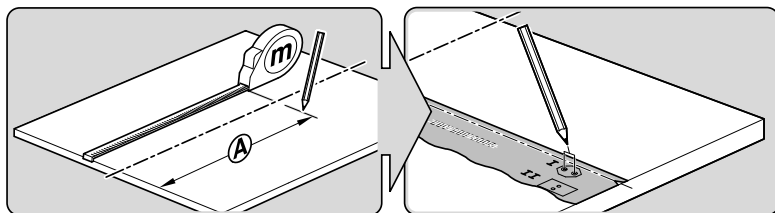
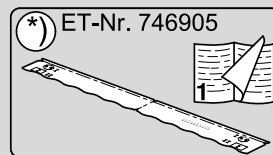
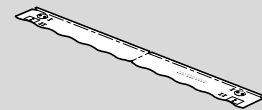
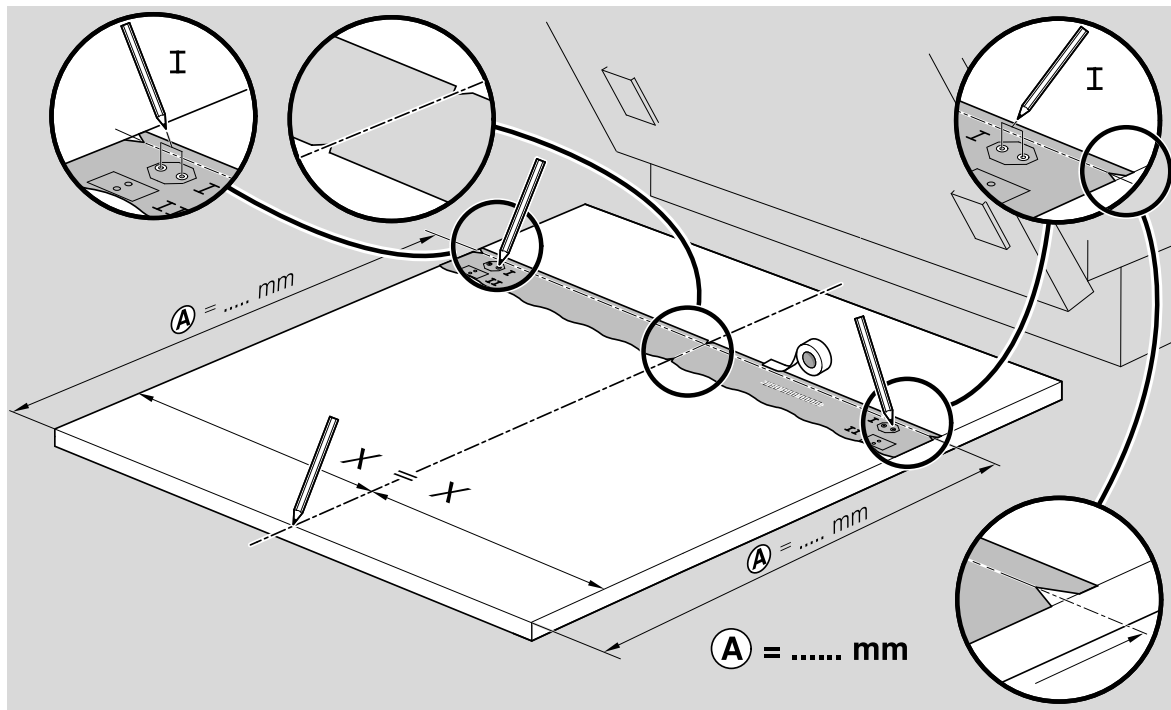

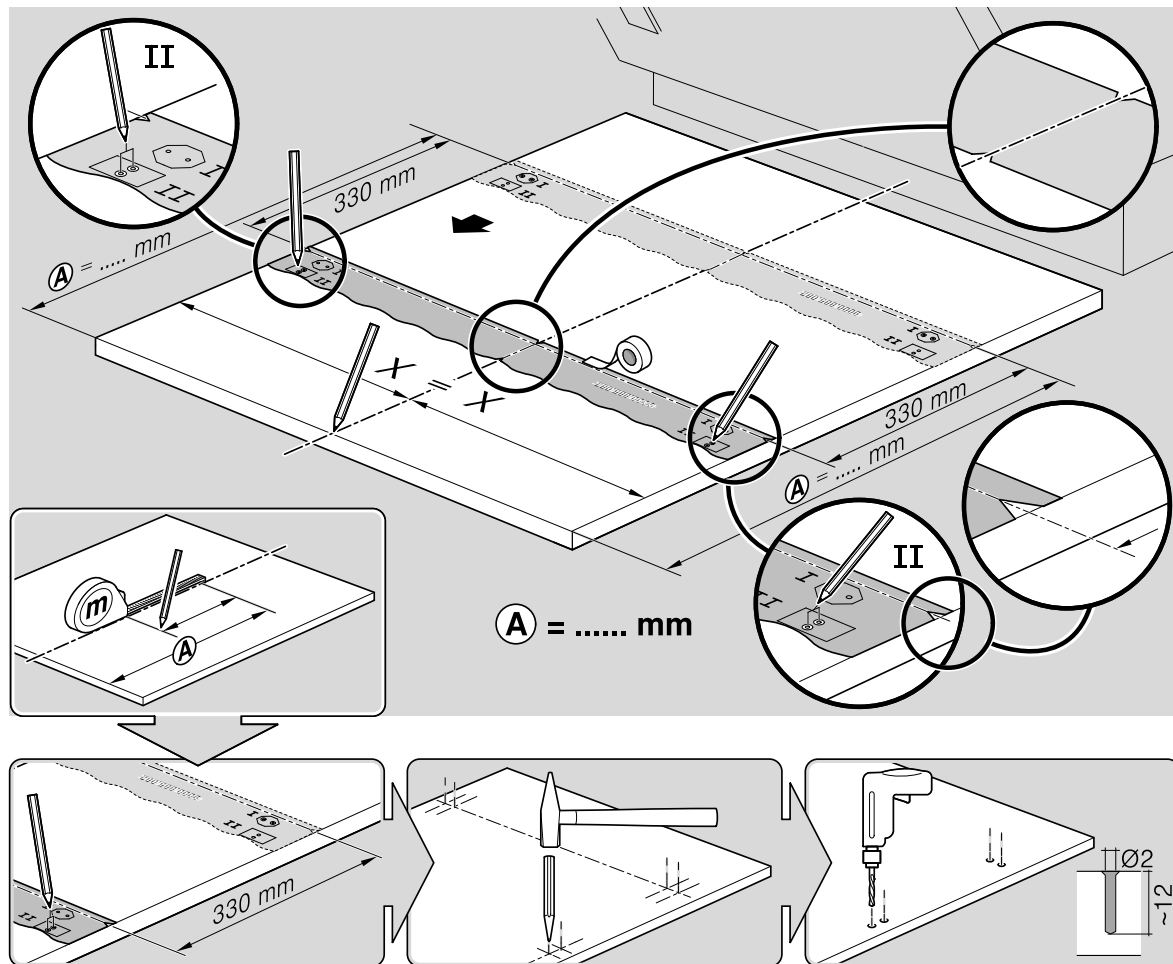

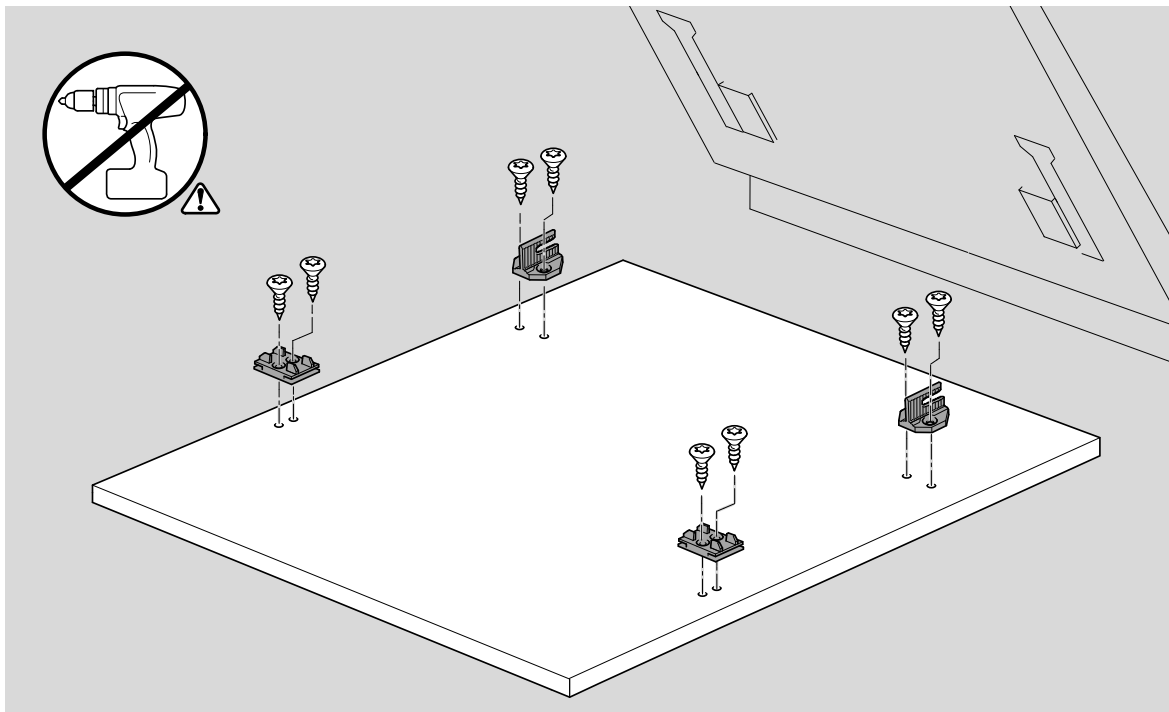

Ø4X15

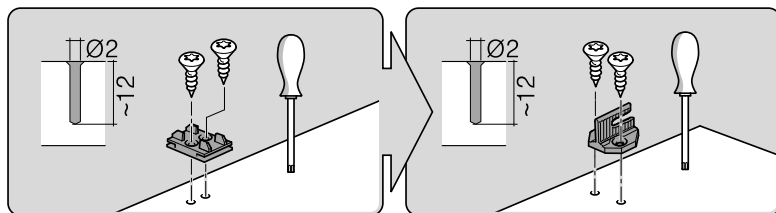
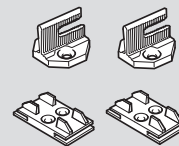
Torx  
T 20

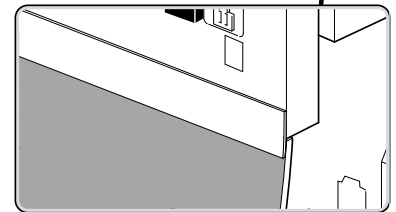
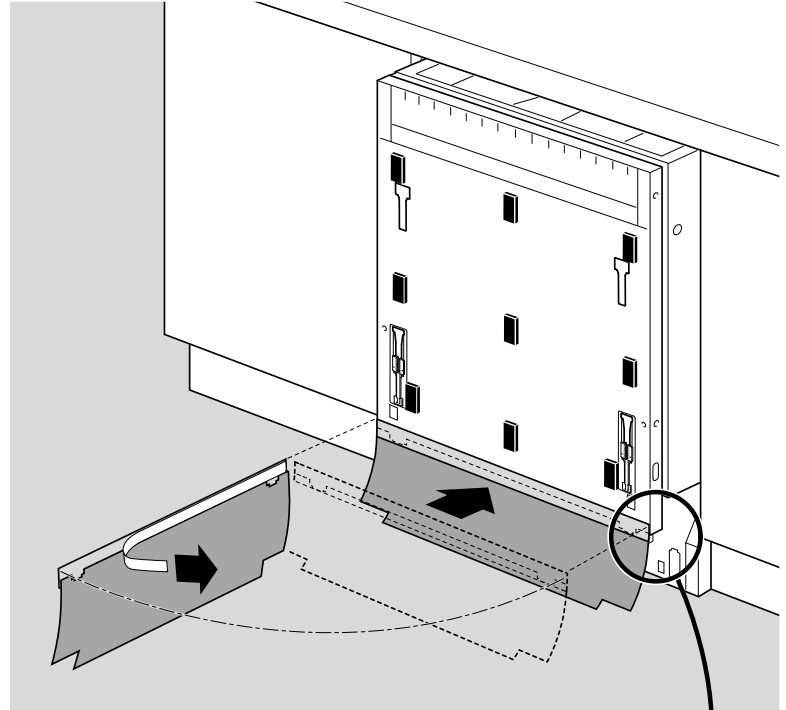
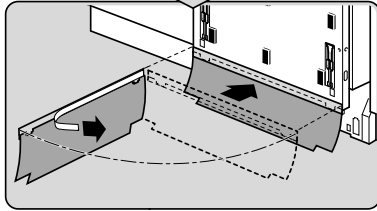
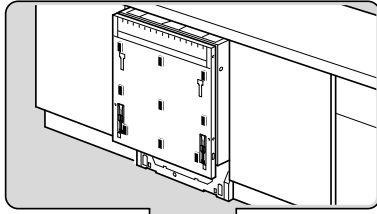
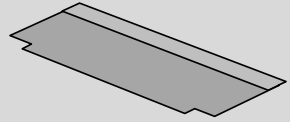

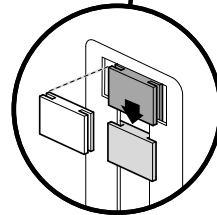
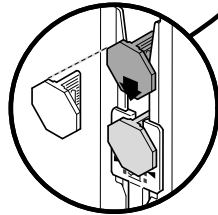
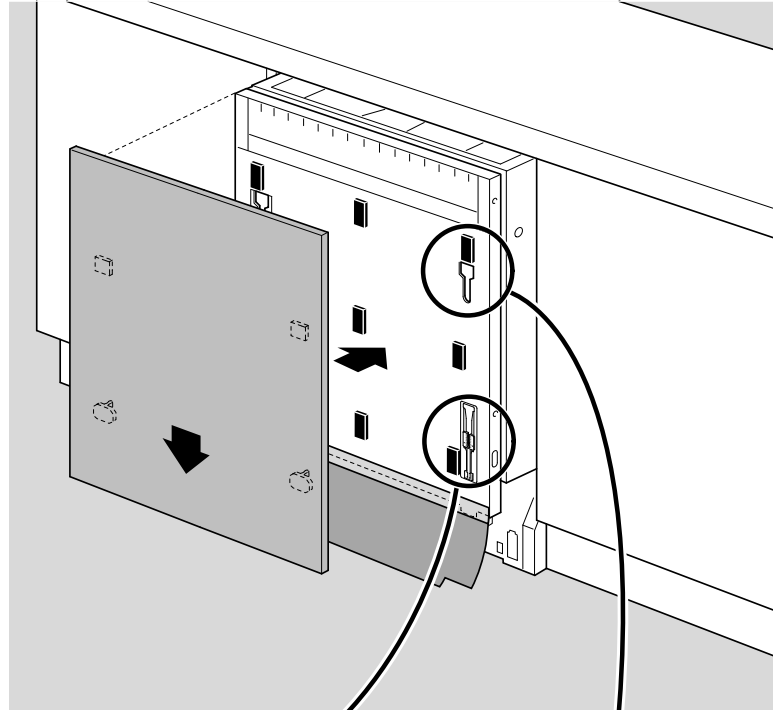
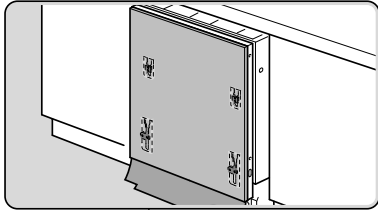

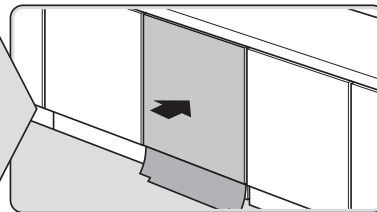
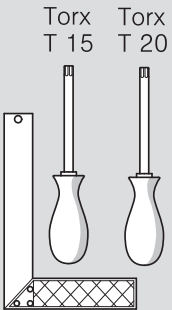
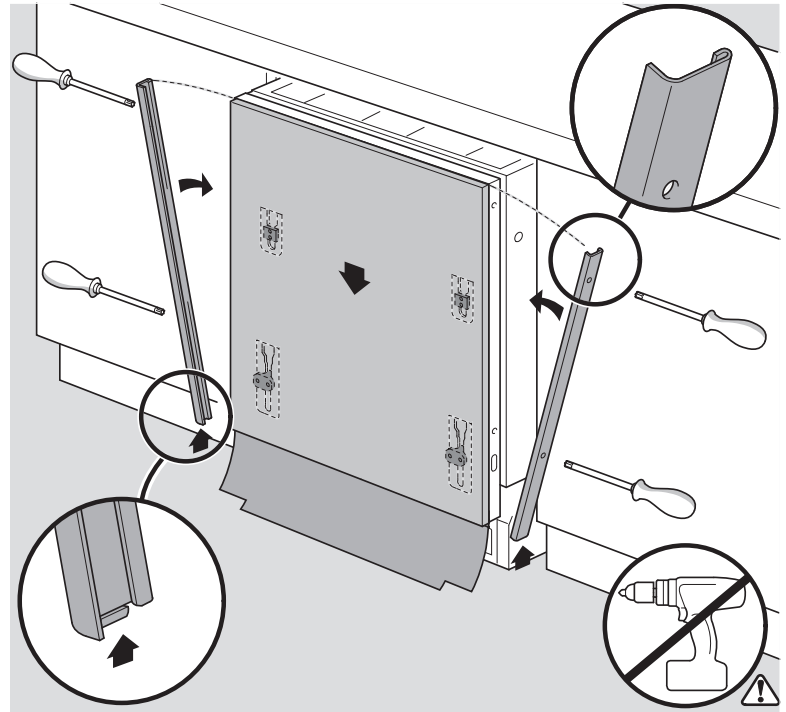
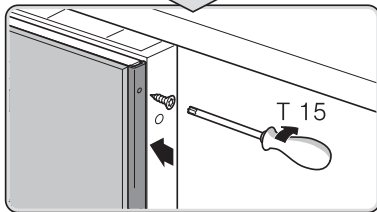
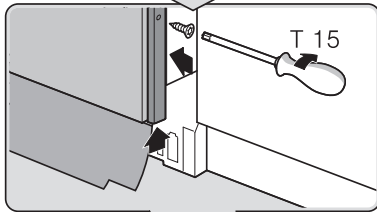
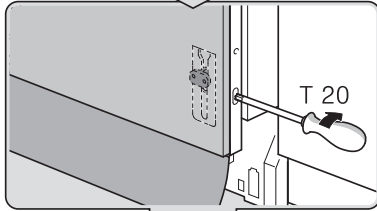
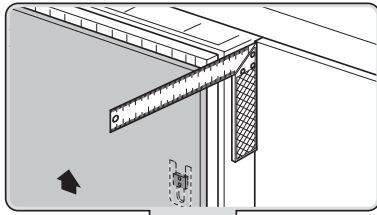

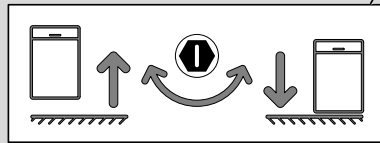
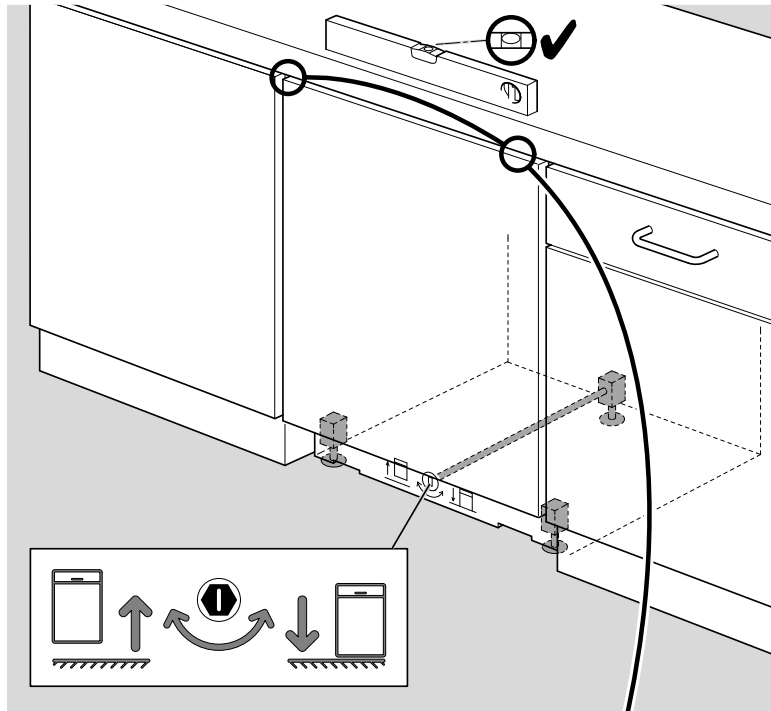
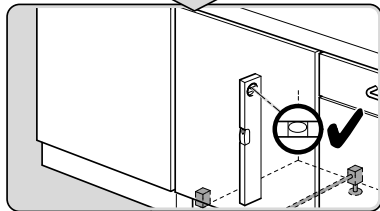
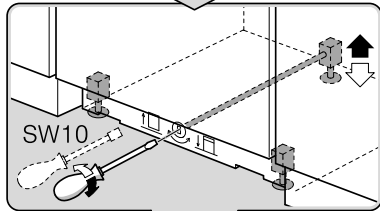
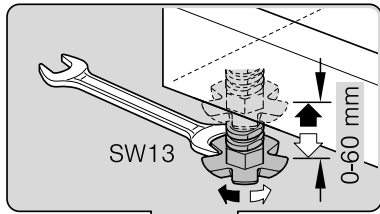

verspannen  
brace  
calar verticalement  
Enrasar

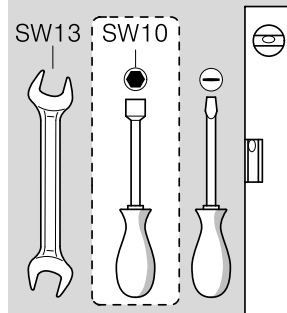
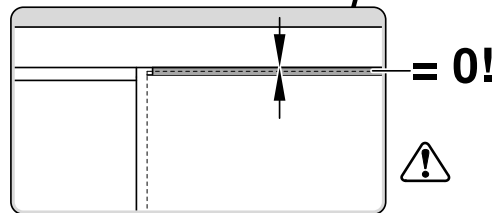





Ø4X30

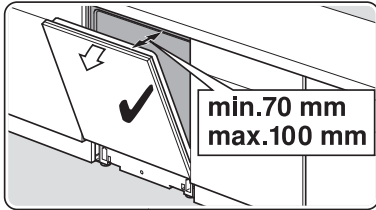
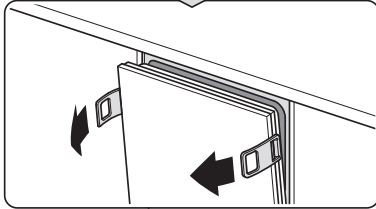
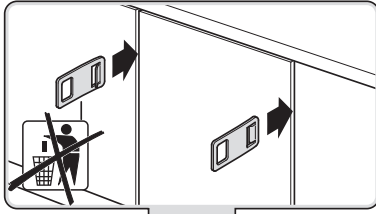
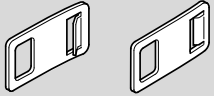
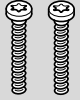

min.70 mm  
max.100 mm

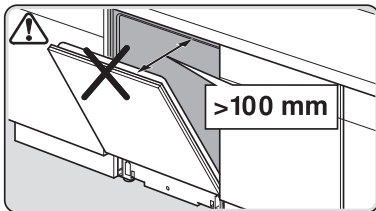

>100 mm

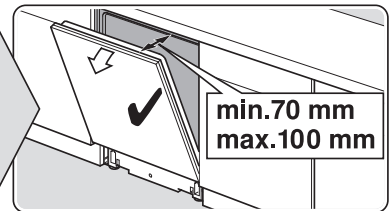
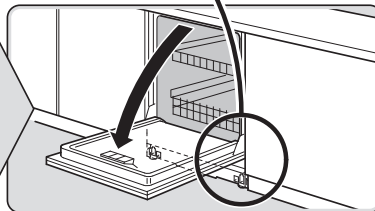

min.70 mm  
max.100 mm

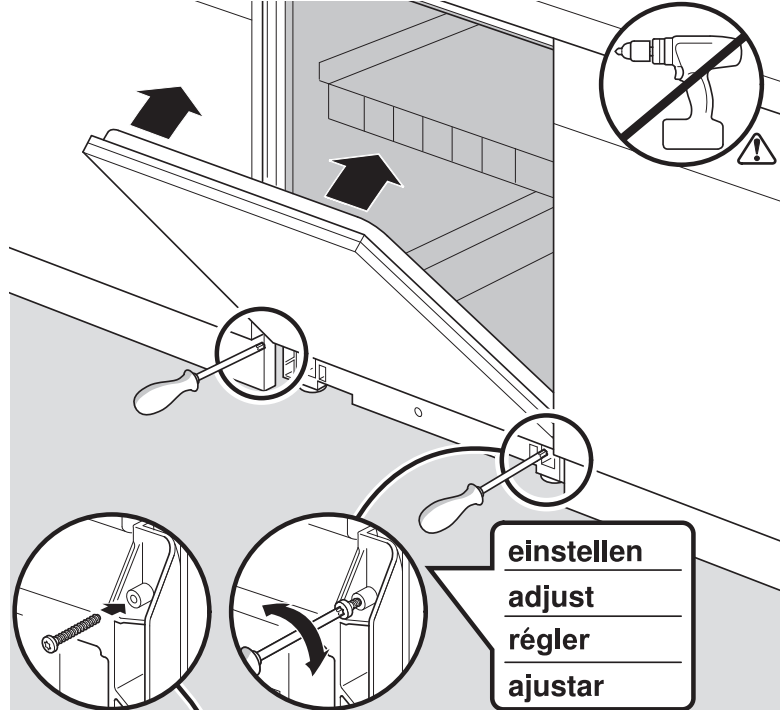

einstellen  
adjust  
régler  
ajustar

Torx  
T 20



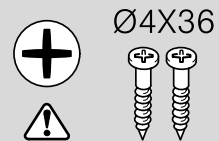
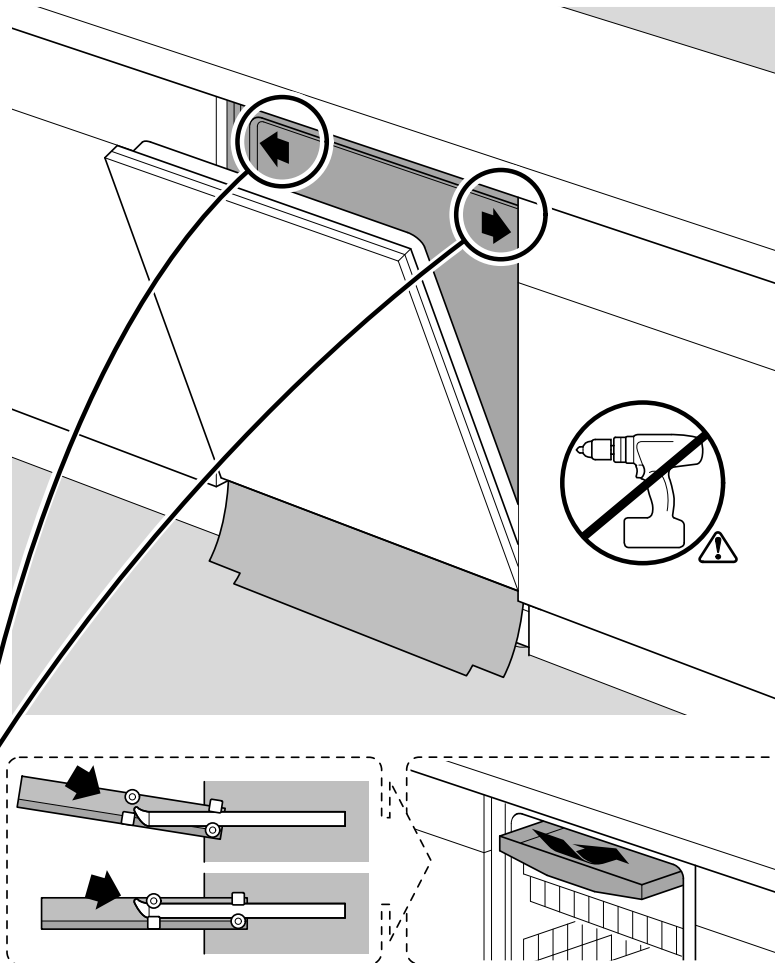
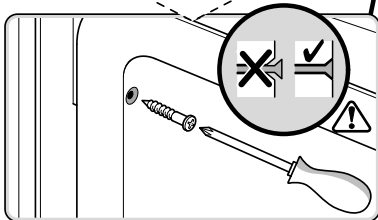
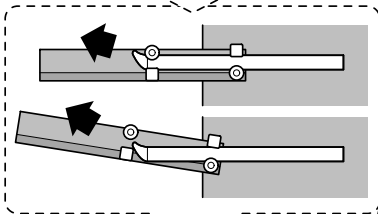
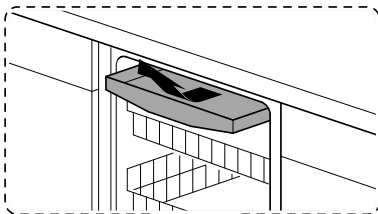
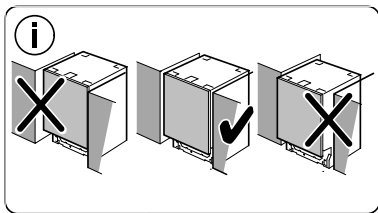

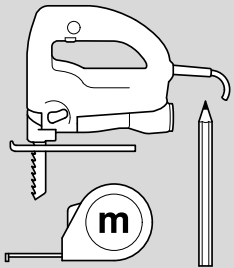
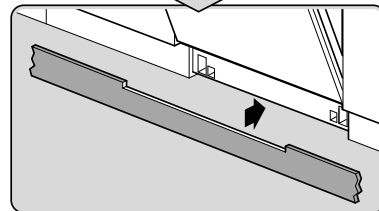
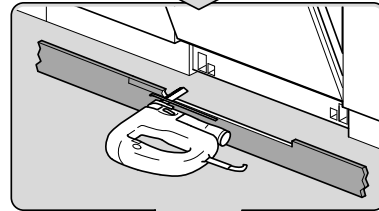
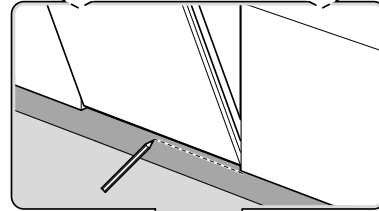
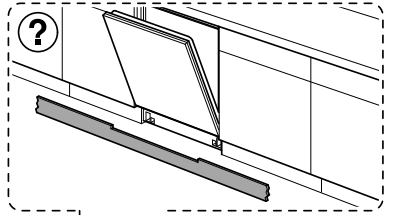
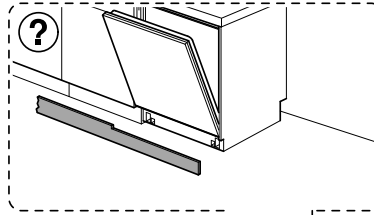
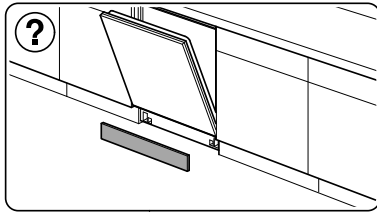

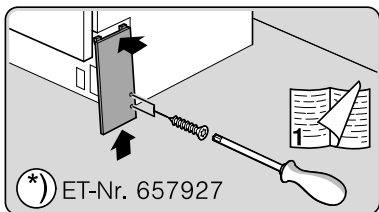
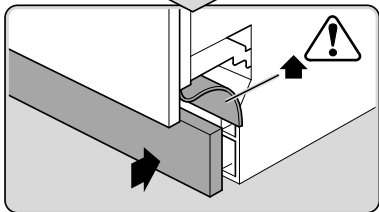
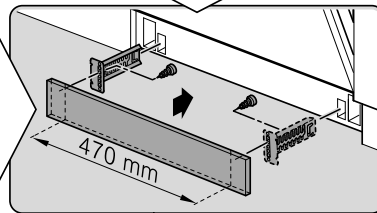
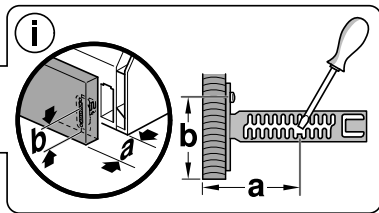
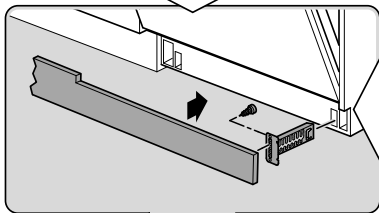
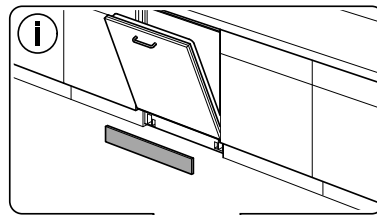
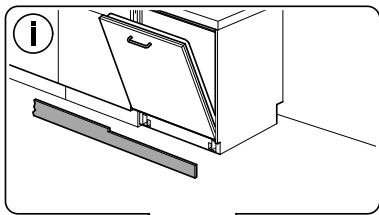

Ø4X15

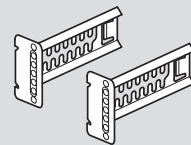

(\*) ET-Nr. 657927

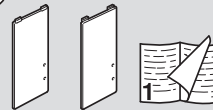

Torx  
T 20



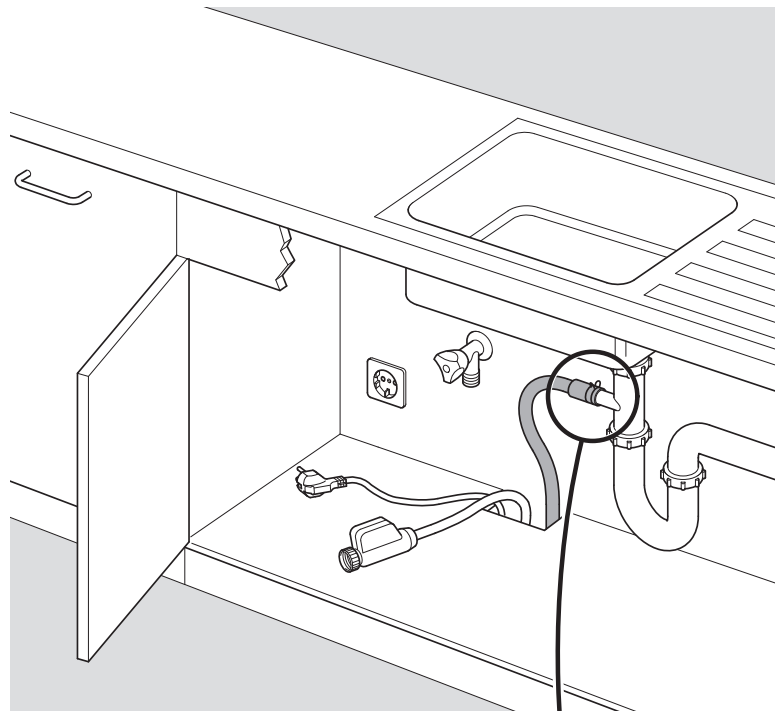
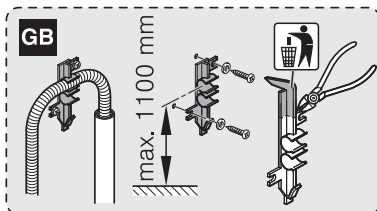
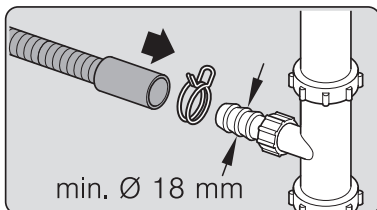
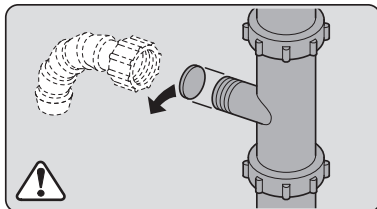
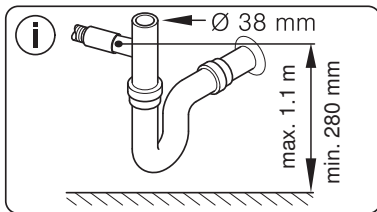

**Dichtheit prüfen**  
**Check for leaks**  
**Verifiez l'étanchéité**  
**Verificar la estanqueidad**

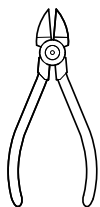
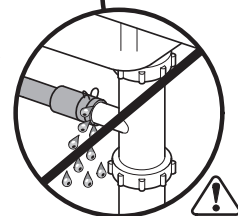

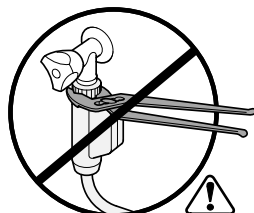
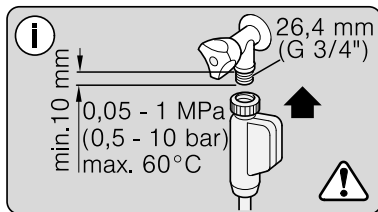

**max. 10 Nm**

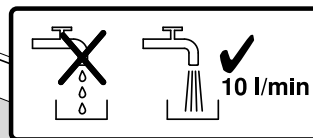
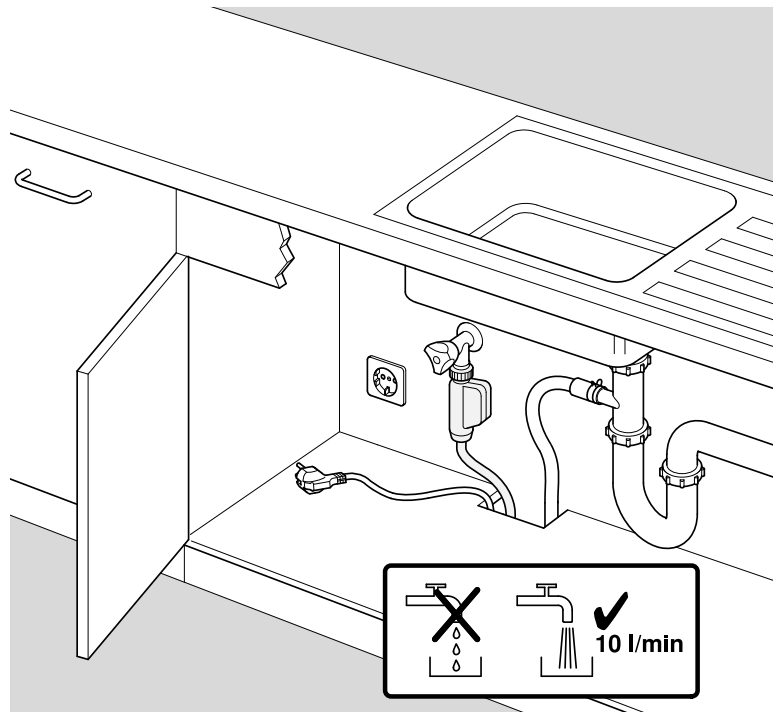

**Dichtheit prüfen**  
**Check for leaks**  
**Verifiez l'étanchéité**  
**Verificar la estanqueidad**



