



Register your new Bosch now:
www.bosch-home.com/welcome



**Free standing cooker
HSA420120**



BOSCH

[en] Instruction manual

Table of contents

Important safety information	4
Causes of damage	6
Damage to the oven.....	6
Damage to the plinth drawer.....	6
Installation and connection	6
For the installer.....	6
Levelling the cooker.....	6
Your new appliance	7
General information.....	7
Hob.....	7
Control panel.....	8
The cooking compartment.....	8
Your accessories	9
Inserting the accessories.....	9
Optional accessories.....	9
After-sales service products.....	10
Before using the oven for the first time	10
Heating up the oven.....	10
Heating up the hotplate.....	10
Cleaning the accessories.....	10
Setting the hob	11
Setting the electric hotplate.....	11
Setting the oven	11
Type of heating and temperature.....	11
Care and cleaning	11
Cleaning agents.....	11
Detaching and refitting the rails.....	13
Detaching and attaching the oven door.....	13
Removing and installing the door panels.....	14
Troubleshooting	15
Malfunction table.....	15
Replacing the bulb in the oven ceiling light.....	15
Glass cover.....	15
After-sales service	15
E number and FD number.....	15
Energy and environment tips	16
Saving energy with your oven.....	16
Saving energy with the hob.....	16
Environmentally-friendly disposal.....	16
Tested for you in our cooking studio	16
Cakes and pastries.....	16
Baking tips.....	18
Meat, poultry, fish.....	18
Tips for roasting and grilling.....	20
Bakes, gratins, toast with toppings.....	20
Preprepared products.....	20
Special dishes.....	21
Preserving.....	21
Acrylamide in foodstuffs	22
Test dishes	22
Baking.....	22
Grilling.....	22

Additional information on products, accessories, replacement parts and services can be found at www.bosch-home.com and in the online shop www.bosch-eshop.com

Important safety information

Read these instructions carefully. Only then will you be able to operate your appliance safely and correctly. Retain the instruction manual for future use or for subsequent owners.

Check the appliance for damage after unpacking it. Do not connect the appliance if it has been damaged in transport.

Only a licensed professional may connect appliances without plugs. Damage caused by incorrect connection is not covered under warranty.

This appliance is intended for domestic use only. The appliance must only be used for the preparation of food and drink. The appliance must be supervised during operation. Only use this appliance indoors.

This appliance is intended for use up to a maximum height of 2000 metres above sea level.

This appliance is not designed for operation with an external timer or by remote control.

Do not use inappropriate child safety shields or hob guards. These can cause accidents.

This appliance may be used by children over the age of 8 years old and by persons with reduced physical, sensory or mental capabilities or by persons with a lack of experience or knowledge if they are supervised or are instructed by a person responsible for their safety how to use the appliance safely and have understood the associated hazards.

Children must not play with, on, or around the appliance. Children must not clean the appliance or carry out general maintenance unless they are at least 8 years old and are being supervised.

Keep children below the age of 8 years old at a safe distance from the appliance and power cable.

Always slide accessories into the cooking compartment correctly. See "*Description of accessories*" in the instruction manual.

Risk of fire!

- Combustible items stored in the cooking compartment may catch fire. Never store combustible items in the cooking compartment. Never open the appliance door if there is smoke inside. Switch off the appliance and unplug it from the

mains or switch off the circuit breaker in the fuse box.

- A draught is created when the appliance door is opened. Greaseproof paper may come into contact with the heating element and catch fire. Do not place greaseproof paper loosely over accessories during preheating. Always weight down the greaseproof paper with a dish or a baking tin. Only cover the surface required with greaseproof paper. Greaseproof paper must not protrude over the accessories.
- Hot oil and fat can ignite very quickly. Never leave hot fat or oil unattended. Never use water to put out burning oil or fat. Switch off the hotplate. Extinguish flames carefully using a lid, fire blanket or something similar.
- The hotplates become very hot. Never place combustible items on the hob. Never place objects on the hob.
- The appliance becomes very hot, and flammable materials can easily catch fire. Do not store or use any flammable objects (e.g. aerosol cans, cleaning agents) under or in the vicinity of the oven. Do not store any flammable objects inside or on top of the oven.
- The surfaces of the plinth drawer may become very hot. Only store oven accessories in the drawer. Flammable and combustible objects must not be stored in the plinth drawer.

Risk of burns!

- The appliance becomes very hot. Never touch the interior surfaces of the cooking compartment or the heating elements. Always allow the appliance to cool down. Keep children at a safe distance.
- Accessories and ovenware become very hot. Always use oven gloves to remove accessories or ovenware from the cooking compartment.
- Alcoholic vapours may catch fire in the hot cooking compartment. Never prepare food containing large quantities of drinks with a high alcohol content. Only use small quantities of drinks with a high alcohol

content. Open the appliance door with care.

- The hotplates and surrounding area (particularly the hob surround, if fitted) become very hot. Never touch the hot surfaces. Keep children at a safe distance.
- During operation, the surfaces of the appliance become hot. Do not touch the surfaces when they are hot. Keep children away from the appliance.
- The hotplate heats up but the display does not work. Switch off the circuit breaker in the fuse box. Contact the after-sales service.
- The appliance becomes hot during operation. Allow the appliance to cool down before cleaning.

Risk of scalding!

- The accessible parts become hot during operation. Never touch the hot parts. Keep children at a safe distance.
- When you open the appliance door, hot steam may escape. Open the appliance door with care. Keep children at a safe distance.
- Water in a hot cooking compartment may create hot steam. Never pour water into the hot cooking compartment.

Risk of injury!

- Scratched glass in the appliance door may develop into a crack. Do not use a glass scraper, sharp or abrasive cleaning aids or detergents.
- Saucepans may suddenly jump due to liquid between the pan base and the hotplate. Always keep the hotplate and saucepan bases dry.
- If the appliance is placed on a base and is not secured, it may slide off the base. The appliance must be fixed to the base.

Risk of tipping!

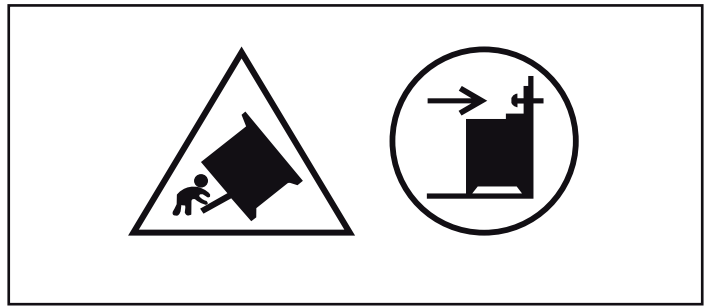

Warning: In order to prevent tipping of the appliance, this stabilizing means must be installed. Refer to the instructions for installation.

Risk of electric shock!

- Incorrect repairs are dangerous. Repairs may only be carried out by one of our trained after-sales engineers. If the appliance is faulty, unplug the mains plug or switch off the fuse in the fuse box. Contact the after-sales service.
- The cable insulation on electrical appliances may melt when touching hot parts of the appliance. Never bring electrical appliance cables into contact with hot parts of the appliance.
- Do not use any high-pressure cleaners or steam cleaners, which can result in an electric shock.
- When replacing the cooking compartment bulb, the bulb socket contacts are live. Before replacing the bulb, unplug the appliance from the mains or switch off the circuit breaker in the fuse box.
- A defective appliance may cause electric shock. Never switch on a defective appliance. Unplug the appliance from the mains or switch off the circuit breaker in the fuse box. Contact the after-sales service.

Causes of damage

Hob

Caution!

- Ensure that the top cover is not closed when the oven is started up.
- Only use the burners when cookware has been placed on top. Do not heat up empty pots or pans. The saucepan base will be damaged.
- Clear up spills immediately. Use deep pots for dishes with a lot of liquid. This will prevent the food from boiling over.
- Ensure that the hotplate/burner is never switched on when the hob cover is on, e.g. by children playing.
- Keep the hotplate dry. Salt water or wet saucepan bases will damage the hotplate.
- Never operate the hotplate without a pot on it. Never use pots with an uneven base. Not enough heat will be drawn from the hotplate. It may glow red.

Damage to the oven

Caution!

- Accessories, foil, greaseproof paper or ovenware on the cooking compartment floor: do not place accessories on the cooking compartment floor. Do not cover the cooking compartment floor with any sort of foil or greaseproof paper. Do not place ovenware on the cooking compartment floor if a temperature of over 50 °C has been set. This will cause heat to accumulate. The baking and roasting times will no longer be correct and the enamel will be damaged.
- Water in a hot cooking compartment: do not pour water into the cooking compartment when it is hot. This will cause

steam. The temperature change can cause damage to the enamel.

- Moist food: do not store moist food in the cooking compartment when it is closed for prolonged periods. This will damage the enamel.
- Fruit juice: when baking particularly juicy fruit pies, do not pack the baking tray too generously. Fruit juice dripping from the baking tray leaves stains that cannot be removed. If possible, use the deeper universal pan.
- Cooling with the appliance door open: only allow the cooking compartment to cool when it is closed. Even if the appliance door is only open a little, front panels of adjacent units could be damaged over time.
- Very dirty door seal: If the door seal is very dirty, the appliance door will no longer close properly when the appliance is in use. The fronts of adjacent units could be damaged. Always keep the door seal clean.
- Appliance door as a seat, shelf or worktop: Do not sit on the appliance door, or place or hang anything on it. Do not place any cookware or accessories on the appliance door.
- Inserting accessories: depending on the appliance model, accessories can scratch the door panel when closing the appliance door. Always insert the accessories into the cooking compartment as far as they will go.
- Carrying the appliance: do not carry or hold the appliance by the door handle. The door handle cannot support the weight of the appliance and could break.

Damage to the plinth drawer

Caution!

Do not place hot objects in the plinth drawer. It could be damaged.

Installation and connection

Electrical connection

The appliance must be connected to the mains by a licensed expert. The regulations of your electricity supplier must be observed.

Any damage arising from the appliance being connected incorrectly will invalidate the guarantee.

Caution!

If the supply cord is damaged, it must be replaced by the manufacturer, its service agent or similarly qualified persons in order to avoid a hazard.

For the installer

- An all-pole isolating switch with a contact gap of at least 3 mm must be present in the installation circuit. This is not necessary if the appliance is connected by a plug that is accessible to the user.
- Electrical safety: The cooker corresponds to safety class I and may only be used in conjunction with a safety earth terminal.
- A type H 05 VV-F or equally rated lead must be used to connect the appliance.

Levelling the cooker

Always place the cooker directly on the floor.

1. Pull out the plinth drawer and lift it up and out. There are adjustable feet at the front and rear on the inside of the plinth.
2. Use an Allen key to raise or lower the adjustable feet as necessary until the cooker is level (picture A).
3. Push the plinth drawer back in (picture B).

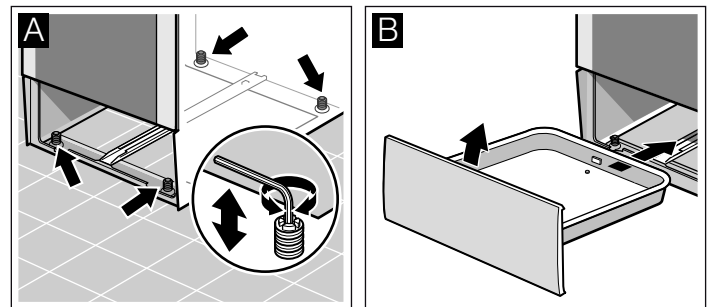

Wall fixing

To prevent the cooker from tipping over, you must fix it to the wall using the enclosed bracket. Please observe the installation instructions for fixing the oven to the wall.

Your new appliance

In this section you will find information on the appliance, the operating modes and the accessories.

General information

The design depends on the respective appliance model.

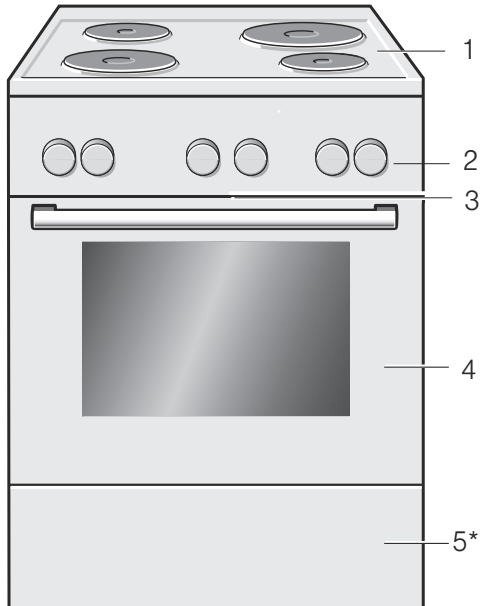

Explanations

1	Hob**
2	Control panel**
3	Cooling fan
4	Oven door**
5*	Plinth drawer**

* Optional (available for some appliances)

** Details may vary depending on the appliance model.

Hob

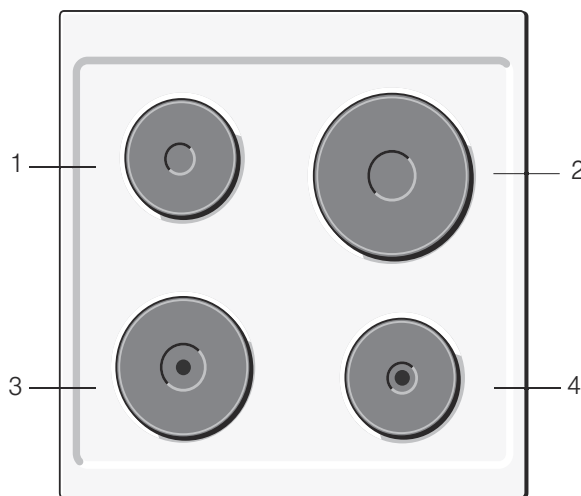

Explanations

1	Hotplate, 14.5 cm
2	Hotplate, 22 cm
3	Rapid hotplate with red point, 18 cm
4	Rapid hotplate with red point, 14.5 cm

Rapid hotplate with red point

If you use the highest heat setting, the hotplate will heat up quickly.





Control panel

Details may vary depending on the appliance model.

Function selector

With the function selector knob you can set the heating mode for the oven. The function selector knob can be rotated to the right or to the left.



When the required type of heating is set, the oven light lights up.

Positions	Function
 Off	The oven is switched off.
 Top/bottom heating*	Baking, roasting or grilling is possible on a single level only. This setting is well-suited for cakes and pizza in tins or on the baking tray, and for lean joints of beef, veal and game. Heat is emitted evenly from the top and bottom.
 Bottom heating	You can use Bottom heating for the final baking stage and for browning meals from the bottom. The heat is emitted from below.
 Radiant grill, small area	Can be used for grilling smaller quantities of steak, sausages, fish, and toasts. The centre part of the grill element is heated.
 Radiant grilling, large area	Can be used to grill a large number of beef steaks, sausages and fish, or to toast bread. The whole area below the grill heating element becomes hot.

* Type of heating in accordance with energy efficiency class EN50304.

Temperature selector

Use the temperature selector to set the temperature and the grill setting.

Positions	Function
 Zero position	Oven not hot.
50-270 Temperature range	Temperature in °C.
1, 2, 3 Grill settings	Grill settings for the  Grill, small area and  Grill, large area. Setting 1 = low Setting 2 = medium Setting 3 = high

The small light above the temperature selector is lit when the oven is heating. If heating is interrupted, it goes out. It does not light up for certain settings.

Hotplate knob

You can adjust the heat setting of the hotplates using the four hotplate knobs.

Positions	Function
0 Zero position	Cooker switched off.
1/2-3 Heat settings	1/2 = lowest setting 3 = highest setting

When you set the electric hotplate, the indicator lamp lights up. You can turn the hotplate knob clockwise or anti-clockwise.

The cooking compartment

The oven light is located in the cooking compartment. A cooling fan protects the oven from overheating.

Oven light

During operation, the oven light in the cooking compartment is on.

Cooling fan

The cooling fan switches on and off as required. The hot air escapes above the door.

So that the cooking compartment cools down more quickly after operation, the cooling fan continues to run for a certain period afterwards.

Caution!

do not cover the ventilation slots. Otherwise the oven will overheat.

Your accessories

The accessories supplied with your appliance are suitable for making many meals. Ensure that you always insert the accessories into the cooking compartment the right way round.

There is also a selection of optional accessories, with which you can improve on some of your favourite dishes, or simply to make working with your oven more convenient.

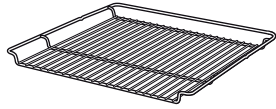

Wire rack

For ovenware, cake tins, roasts, grilling and frozen meals.

Slide the wire rack into the oven with the open side facing the oven door and the curvature pointing downwards .



Enamel baking tray

For cakes and biscuits.

Push the baking tray into the oven with the sloping edge facing towards the oven door.

The accessories can be pulled out approximately halfway without tipping. This allows meals to be taken out easily.

When placing the accessories into the oven, check that the indentation is at the back. They can only lock correctly in place in this position.

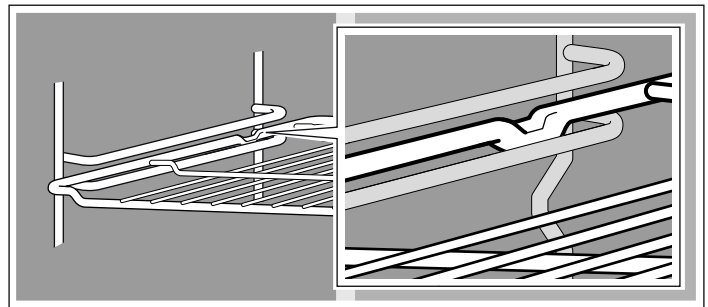

Note: Heat may cause the accessories to deform. As soon as the accessories cool down, they regain their original shape. Their function is not adversely affected.

Hold the baking tray securely on the sides with both hands and push it parallel into the frame. Avoid movements to the right or left when pushing the baking tray in. Otherwise, it will be difficult to push the tray in and the enamelled surfaces could be damaged.

You can buy accessories from the after-sales service, from specialist retailers or online. Please specify the HEZ number.

Inserting the accessories

The accessories can be inserted in the oven at 5 different levels. Always slide the accessories fully in to avoid them coming into contact with the oven's glass door.

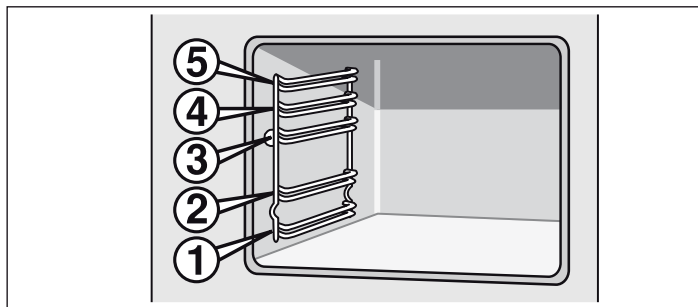

Optional accessories

You can buy optional accessories from your after-sales service or from specialist retailers. You will find a variety of suitable products for your oven in our brochures and on the Internet. The availability of optional accessories and the options for ordering them on the internet vary depending on the country. You can find information about this in the sales brochures.

Not every optional accessory is suitable for every appliance. When making a purchase, always quote the full name (E no.) of your appliance.

Optional accessories	HEZ number	Function
Pizza tray	HEZ317000	Particularly good for pizza, frozen meals and round tarts. You can use the pizza tray instead of the universal pan. Slide the tray in above the wire rack and proceed according to the instructions in the tables.
Wire insert	HEZ324000	For roasting. Always place the grill wire rack on the universal pan. This ensures that dripping fat and meat juices are collected.
Grill tray	HEZ325000	Used for grilling instead of the grill wire rack or used as a splatter guard to protect the oven from becoming heavily soiled. Only use the grill tray with the universal pan. Grilling on the grill tray: only shelf positions 1, 2 and 3 can be used. The grill tray as a splash guard: the universal pan is inserted together with the grill tray under the wire rack.
Baking stone	HEZ327000	The baking stone is perfect for preparing home-made bread, bread rolls and pizzas which require a crispy base. The baking stone must always be preheated to the recommended temperature.
Enamel baking tray	HEZ331003	For cakes and biscuits. Slide the baking tray into the oven with the sloping edge facing towards the oven door.
Enamel baking tray with non-stick coating	HEZ331011	The baking tray is ideal for laying out cakes and biscuits. Slide the baking tray into the oven with the sloping edge facing towards the oven door.

Optional accessories	HEZ number	Function
Universal pan	HEZ332003	For moist cakes, pastries, frozen meals and large roasts. Can also be used under the wire rack to catch fat or meat juices. Slide the universal pan into the oven with the sloping edge facing towards the oven door.
Universal pan with non-stick coating	HEZ332011	This universal pan is ideal for moist cakes, pastries, frozen meals and large roasts. Slide the universal pan into the oven with the sloping edge facing towards the oven door.
Lid for the Profi extra-deep pan	HEZ333001	The lid converts the Profi extra-deep pan into the Profi roasting dish.
Profi extra-deep pan with insert wire rack	HEZ333003	Particularly suitable for preparing large quantities of food.
Wire rack	HEZ334000	For ovenware, cake tins, roasts, grilling and frozen meals.
Telescopic shelf rail		
2-level shelf rail	HEZ338250	With the pull-out rails at level 2 and 3, the accessories can be fully pulled out without tipping.
Glass roasting dish	HEZ915001	The glass roasting dish is suitable for pot roasts and bakes. Ideal for programmes and automatic roasting.

After-sales service products

You can obtain suitable care and cleaning agents and other accessories for your domestic appliances from the after-sales

service, specialist retailers or (in some countries) online via the e-Shop. Please specify the relevant product number.

Cleaning cloths for stainless-steel surfaces	Product no. 311134	Reduces the build-up of dirt. Impregnated with a special oil for perfect maintenance of your appliance's stainless-steel surfaces.
Oven and grill cleaning gel	Product no. 463582	For cleaning the cooking compartment. The gel is odourless.
Microfibre cloth with honeycomb structure	Product no. 460770	Especially suitable for cleaning delicate surfaces, such as glass, glass ceramic, stainless steel or aluminium. The microfibre cloth removes liquid and grease deposits in one go.
Door lock	Product no. 612594	To prevent children from opening the oven door. The locks on different types of appliance door are screwed in differently. See the information sheet supplied with the door lock.

Before using the oven for the first time

In this section, you can find out what you must do before using your oven to prepare food for the first time. First read the section on *Safety information*.

Heating up the oven

To remove the new cooker smell, heat up the oven when it is empty and closed. An hour of Top/bottom heating  at 240 °C is ideal for this purpose. Ensure that no packaging remnants have been left in the cooking compartment.

Keep the kitchen ventilated the whole time the oven is on.

1. Use the function selector to set Top/bottom heating .
2. Set the temperature selector to 240 °C.

After an hour, switch off the oven. To do so, turn the function selector to the off position.

Heating up the hotplate

To remove the new appliance smell, heat up the hotplate without a saucepan at the highest level for 3 minutes.

Cleaning the accessories

Before you use the accessories for the first time, clean them thoroughly with hot soapy water and a soft dish cloth.

Setting the hob

In this section, you can find out how to set the cooker.

Setting the electric hotplate

You can set the heat setting using the hotplate knob for the required electric hotplate.

Proceed as follows:

1. Set the switch for the electric hotplate anti-clockwise to a suitable heat setting between $\frac{1}{2}$ and 3.
2. For cooking, use a pan which has the same diameter as the electric hotplate.
3. When the dish has finished cooking, switch the electric hotplate off (heat setting 0).

Heat setting $\frac{1}{2}$ = lowest setting
Heat setting 3 = highest setting

Type of heating	$\frac{1}{2}$ or 1	Depends on amount
Cooking	3	When you start cooking During cooking, setting high or low as required
	1	
Baking	3	Heating the oil, When you start baking During baking
	2	

The display lights up when the hotplate is switched on.

You can turn the hotplate knob clockwise or anti-clockwise.

Setting the oven

There are various ways in which you can set your oven. Here we will explain how you can select the desired type of heating and temperature or grill setting.

Note: We recommend preheating the oven before inserting the food in order to avoid condensation on the oven glass.

Type of heating and temperature

Example in the picture: Top/bottom heating at 190 °C .

1. Use the function selector to set the type of heating.

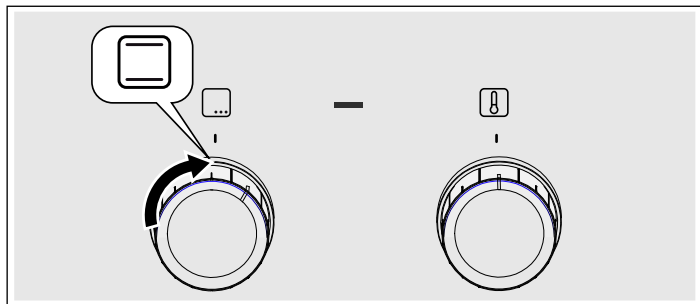

2. Set the temperature or grill setting using the temperature selector.

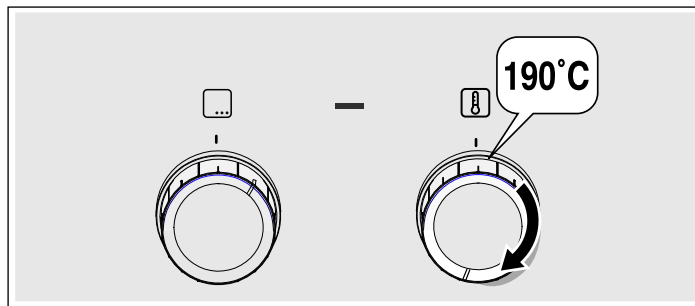

The oven heats up.

Switching off the oven

Turn the function selector to the off position.

Changing the settings

The type of heating and temperature or grill setting can be changed at any time using their respective selectors.

Care and cleaning

With attentive care and cleaning, your hob and oven will retain its looks and remain in good working order for a long time. We will explain here how you should care for and clean them correctly.

Notes

- Slight differences in the colours on the front of the oven are caused by the use of different materials, such as glass, plastic and metal.
- Shadows on the door panel which look like streaks, are caused by reflections made by the oven light.
- Enamel is baked on at very high temperatures. This can cause some slight colour variations. This is normal and does not affect operation. The edges of thin trays cannot be completely enamelled. As a result, these edges can be rough. This will not impair the anti-corrosion protection.

Cleaning agents

Damage to the various different surfaces caused by using the wrong cleaning agent can be avoided by observing the following instructions.

When cleaning the hob do not use

- undiluted washing-up liquid or dishwasher detergent,
- scouring pads,
- abrasive cleaning agents such as oven cleaner or stain remover,
- high-pressure cleaners or steam jets.
- Do not clean individual parts in the dishwasher.

When cleaning the oven do not use

- sharp or abrasive cleaning agents,
- cleaning agent with a high alcohol content,
- scouring pads,
- high-pressure cleaners or steam jets.
- Do not clean individual parts in the dishwasher.

Wash new sponges thoroughly before first use.

Zone	Cleaning agent
Stainless steel surfaces* (depending on appliance model)	Hot soapy water: Clean with a dish cloth and dry with a soft cloth. On stainless steel surfaces, always wipe parallel to the natural grain. Otherwise, you may scratch the surface. Remove patches and splashes of limescale, grease, starch and albumin (e.g. egg white) immediately. Corrosion can form under such patches and splashes. Special care products suitable for hot stainless steel surfaces are available from our after-sales service and from specialist retailers. Apply a thin layer of care product with a soft cloth.
Enamel, painted, plastic and screen-printed surfaces* (depending on appliance model)	Hot soapy water: Clean with a dish cloth and dry with a soft cloth. Do not use glass cleaner or glass scrapers for cleaning.
Control panel	Hot soapy water: Clean with a dish cloth and dry with a soft cloth. Do not use glass cleaner or glass scrapers for cleaning.
Upper glass cover* (depending on appliance model)	Glass cleaner: Clean with a soft cloth. You can remove the upper glass cover for cleaning. To find out how to do this, please refer to the section <i>Upper glass cover</i> .
Rotary knobs Do not remove.	Hot soapy water: Clean with a dish cloth and dry with a soft cloth.
Hob surround	Hot soapy water: Do not clean with a glass scraper, lemon juice or vinegar.
Gas hob and pan supports* (depending on appliance model)	Hot soapy water. Use very little water. Water must not be allowed to enter the appliance through the base of the burners. Clean off boiled-over liquids and spilt food immediately. You can remove the pan supports. Cast iron pan supports*: Do not clean in the dishwasher.
Gas burners* (depending on appliance model)	Remove the burner head and cap and clean with hot soapy water. Do not clean in the dishwasher. The gas outlet openings must remain unobstructed at all times. Ignition plugs: Small, soft brush. The gas burners only work properly when the ignition plugs are dry. Dry all parts thoroughly. Ensure that they are refitted correctly. The burner caps are coated in black enamel. The colour may change over time. This does not impair their performance.

* Optional (available for some appliances, depending on the appliance model)

Zone	Cleaning agent
Electric hotplate* (depending on appliance model)	Abrasive materials or sponges: Briefly heat up the hotplate afterwards, so that it dries. Hotplates can rust over time if they remain wet. Apply care product to finish. Clean off boiled-over liquids and spilt food immediately.
Hotplate ring* (depending on appliance model)	Remove yellow to blue iridescent discoloration from the hotplate ring with a steel care product. Do not use any abrasive materials that may scratch surfaces.
Ceramic hob* (depending on appliance model)	Care: Protective/care products for ceramics Cleaning: Cleaning agents suitable for ceramics. Follow the cleaning instructions on the packaging. ⚠ Glass scraper for stubborn dirt: Remove the protective cover and clean using the blade only. Caution: The blade is very sharp. Risk of injury. Cover the blade again after cleaning. Replace damaged blades immediately.
Glass hob* (depending on appliance model)	Care: Protective/care products for glass Cleaning: Cleaning agents for glass. Follow the cleaning instructions on the packaging. ⚠ Glass scraper for stubborn dirt: Remove the protective cover and clean using the blade only. Caution: The blade is very sharp. Risk of injury. Cover the blade again after cleaning. Replace damaged blades immediately.
Glass panel	Glass cleaner: Clean with a soft cloth. Do not use the glass scraper. The door can be removed to facilitate cleaning. To find out how to do this, please refer to the section <i>Removing and refitting the oven door</i> .
Childproof lock* (depending on appliance model)	Hot soapy water: Clean with a dish cloth. If a childproof lock has been fitted to the oven door, it must be removed before cleaning. If it is very dirty, the childproof lock will not work properly.
Seal Do not remove.	Hot soapy water: Clean with a dish cloth. Do not scour.
Cooking zone	Hot soapy water or a vinegar solution: Clean with a dish cloth. For stubborn dirt, use a stainless steel scouring pad or oven cleaner. Only use when the cooking compartment is cold. ⚠ Please use the self-cleaning function to clean self-cleaning surfaces. To find out how to do this, please refer to the section <i>Self-cleaning</i> . Caution! Never use oven cleaner on self-cleaning surfaces.
Glass cover for the oven light	Hot soapy water: Clean with a dish cloth.

* Optional (available for some appliances, depending on the appliance model)

Zone	Cleaning agent
Shelf	<p>Hot soapy water: Clean with a dish cloth or a brush.</p> <p>You can remove the shelves for cleaning. To find out how to do this, please refer to the section <i>Removing and refitting shelves</i>.</p>
	<p>Telescoping extension rails* (depending on appliance model)</p> <p>Hot soapy water: Clean with a dish cloth or a brush.</p> <p>Do not remove the lubricant from the extension rails. It is best to clean them when they are pushed in. Do not soak, clean in the dishwasher, or clean in the oven as part of the self-cleaning programme. This may damage the shelves and they may no longer work properly as a result.</p>
Accessories	<p>Hot soapy water: Soak and then clean with a dish cloth or a brush.</p> <p>Aluminium baking tray*: (depending on appliance model)</p> <p>Dry with a soft cloth. Do not clean in the dishwasher. Never use oven cleaner. To prevent scratches, never touch the metal surfaces with a knife or a similar sharp object. Harsh cleaning products, scratchy sponges and rough cleaning cloths are not suitable. Otherwise, you may scratch the surface.</p> <p>Rotary spit* (depending on appliance model)</p> <p>Hot soapy water: Clean with a dish cloth or a brush. Do not clean in the dishwasher.</p> <p>Meat thermometer* (depending on appliance model)</p> <p>Hot soapy water: Clean with a dish cloth or a brush. Do not clean in the dishwasher.</p>
Plinth drawer* (depending on appliance model)	<p>Hot soapy water: Clean with a dish cloth.</p>

* Optional (available for some appliances, depending on the appliance model)

Detaching and refitting the rails

The rails can be removed for cleaning. The oven must have cooled down.

Detaching the rails

1. Lift up the front of the rail
2. and unhook it (figure A).
3. Then pull the whole rail forward
4. and remove it (Fig. B).

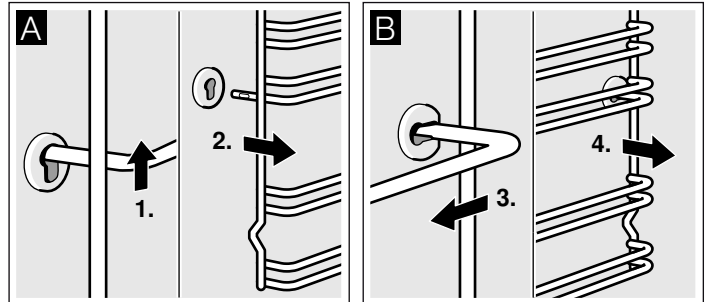

Clean the rails with cleaning agent and a sponge. For stubborn deposits of dirt, use a brush.

Refitting the rails

1. First insert the rail into the rear socket, press it to the back slightly (figure A),
2. and then hook it into the front socket (figure B).

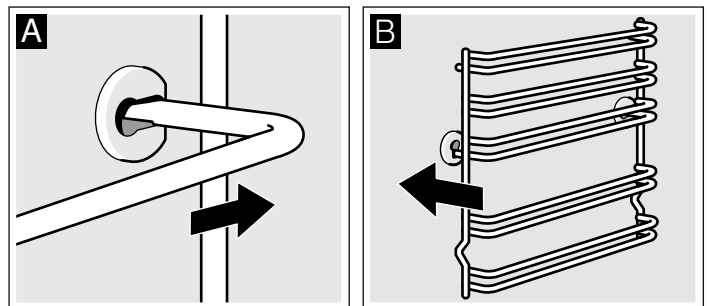

The rails fit both the left and right sides. Ensure that, as shown in figure B, levels 1 and 2 are below and levels 3, 4 and 5 are above.

Detaching and attaching the oven door

For cleaning purposes and to remove the door panels, you can detach the oven door.

The oven door hinges each have a locking lever. When the locking levers are closed (figure A), the oven door is secured in place. It cannot be detached. When the locking levers are open in order to detach the oven door (Fig. B), the hinges are locked. They cannot snap shut.

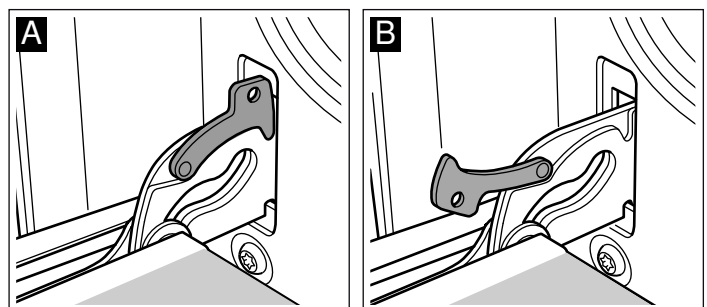

⚠ Risk of injury!

Whenever the hinges are not locked, they snap shut with great force. Ensure that the locking levers are always fully closed or, when detaching the oven door, fully open.

Detaching the door

1. Open the oven door fully.
2. Fold up the two locking levers on the left and right (figure A).
3. Close the oven door as far as the limit stop. With both hands, grip the door on the left and right-hand sides. Close the door a little further and pull it out (figure B).

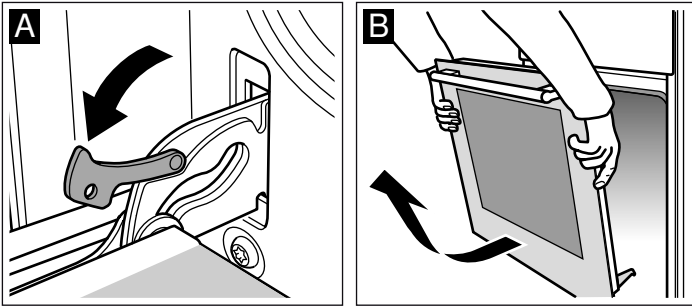

Attaching the door

Reattach the oven door in the reverse sequence to removal.

1. When attaching the oven door, ensure that both hinges are inserted straight into the opening (figure A).
2. The notch on the hinge must engage on both sides (figure B).

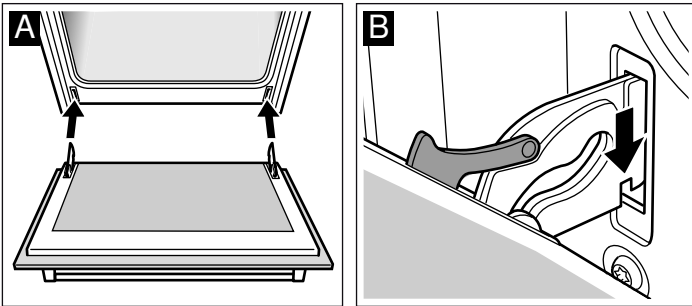

3. Fold back both locking levers (figure C). Close the oven door.

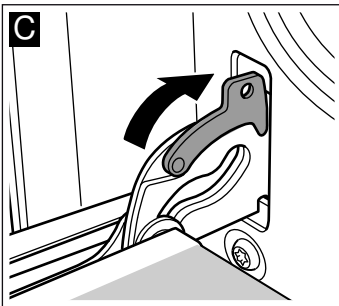

⚠ Risk of injury!

If the oven door falls out accidentally or a hinge snaps shut, do not reach into the hinge. Call the after-sales service.

Removing and installing the door panels

To facilitate cleaning, you can remove the glass panels from the oven door.

Removal

1. Detach the oven door and lay it on a cloth with the handle facing down.
2. Pull off the cover at the top of the oven door. Press in the tabs on the left and right using your fingers (fig. A).
3. Lift the top panel up and pull it out (fig. B).

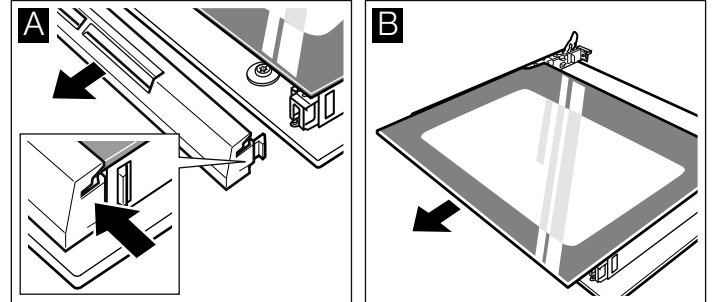

4. Lift the panel up and pull it out (fig. C).

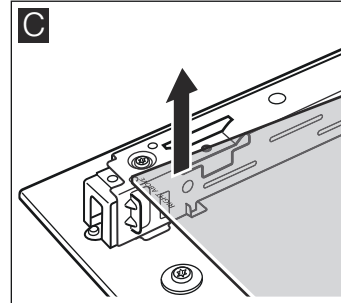

Clean the panels with glass cleaner and a soft cloth.

⚠ Risk of injury!

Scratched glass in the appliance door may develop into a crack. Do not use a glass scraper, sharp or abrasive cleaning aids or detergents.

Installation

During installation, make sure that the lettering "top right" is upside down at the bottom left.

1. Insert the panel at an angle towards the back (fig. A).
2. Insert the top panel at an angle towards the back into the brackets. The smooth surface must face outwards. (fig. B).

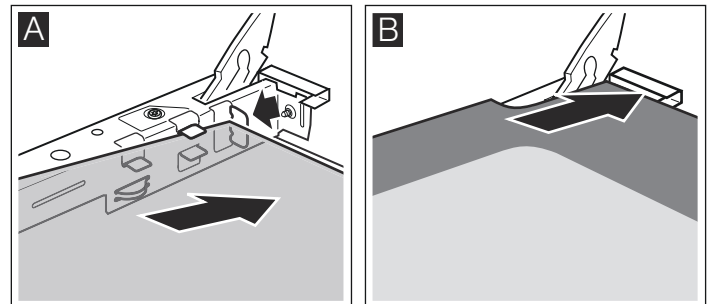

3. Put the cover back in place and press on it.
4. Attach the oven door.

Do not use the oven again until the panels have been correctly installed.

Troubleshooting

Malfunctions often have simple explanations. Refer to the table before calling the after-sales service as you may be able to remedy the fault yourself.

Malfunction table

If a dish doesn't turn out as well as you had hoped, refer to the section *Tested for you in our cooking studio*, where you will find plenty of cooking tips and tricks.

Problem	Possible cause	Remedy/information
The oven does not work.	The circuit breaker is defective.	Look in the fuse box and check that the circuit breaker is in working order.
	Power cut	Check whether the kitchen light or other kitchen appliances are working.
The oven does not heat up.	There is dust on the contacts.	Turn the control knobs back and forth several times.

Risk of electric shock!

Incorrect repairs are dangerous. Repairs may only be carried out by one of our trained after-sales engineers.

Replacing the bulb in the oven ceiling light

If the bulb in the oven light fails, it must be replaced. Heat-resistant, 40 watt spare bulbs can be obtained from our after-sales service or a specialist retailer. Only use these bulbs.

Risk of electric shock!

Switch off the circuit breaker in the fuse box.

1. Place a tea towel in the oven when it is cold to prevent damage.
2. Unscrew the glass cover by turning it anti-clockwise.

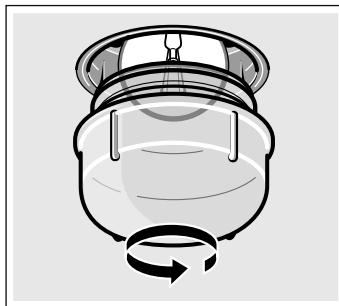

3. Replace the bulb with one of the same type.
4. Screw the glass cover back in.
5. Remove the tea towel and switch on the circuit breaker.

Glass cover

You must replace a damaged glass cover. Suitable glass covers may be obtained from the after-sales service. Please specify the E number and FD number of your appliance.

After-sales service

Our after-sales service is there for you if your appliance needs to be repaired. We will always find the right solution in order to avoid unnecessary visits from a service technician.

E number and FD number

When calling us, please give the product number (E no.) and the production number (FD no.) so that we can provide you with the correct advice. The rating plate containing these numbers can be found on the right-hand side of the oven door. You can make a note of the numbers of your appliance and the telephone number of the after-sales service in the space below to save time should it be required.

E no.	FD no.
-------	--------

After-sales service

Please note that there will be a fee for a visit by a service technician in the event of a malfunction, even during the warranty period.

After-sales contact details for all countries can be found in the attached after-sales service directory.

Energy and environment tips

Here you can find tips on how to save energy when baking and roasting in the oven and when cooking on the hob, and how to dispose of your appliance properly.

Saving energy with your oven

- Only preheat the oven if this is specified in the recipe or in the operating instruction tables.
- Use dark, black lacquered or enamelled baking tins. They absorb the heat particularly well.
- Open the oven door as infrequently as possible while cooking, baking or roasting.
- It is best to bake more than one cake, one after the other. The oven is still warm. This reduces the baking time for the second cake. You can also place two loaf tins next to each other.
- For longer cooking times, you can switch the oven off 10 minutes before the end of the cooking time and use the residual heat to finish cooking.

Saving energy with the hob

- Use pots and pans with thick, even bases. Uneven bases increase energy consumption.
- The diameter of pan bases should be the same size as the hotplate. In particular, small saucepans on the hotplate cause

energy losses. Note that cookware manufacturers often indicate the upper diameter of the saucepan. This is usually bigger than the diameter of the base of the pan.

- Use a small saucepan for small quantities. A larger, less full saucepan requires a lot of energy.
- Always place suitable lids on saucepans. When cooking without a lid, four times the energy is required.
- Cook with only a little water. This will save energy. Vitamins and minerals in vegetables are preserved.
- Switch to a lower heat setting in good time.
- Use the residual heat. For longer cooking times, you can switch the hotplate off 5-10 minutes before the end of the cooking time.

Environmentally-friendly disposal

Dispose of packaging in an environmentally-friendly manner.



This appliance is labelled in accordance with European Directive 2012/19/EU concerning used electrical and electronic appliances (waste electrical and electronic equipment - WEEE). The guideline determines the framework for the return and recycling of used appliances as applicable throughout the EU.

Tested for you in our cooking studio

Here you will find a selection of dishes and the ideal settings for them. We will show you which type of heating and which temperature are best suited for your dish. You can find information about suitable accessories and the height at which they should be inserted. There are also tips about cookware and preparation methods.

Notes

- The values in the table always apply to dishes placed into the cooking compartment when it is cold and empty.
Only preheat the appliance if the table specifies that you should do so. Do not line the accessories with greaseproof paper until after they have been preheated.
- The times specified in the tables are guidelines only. They will depend on the quality and composition of the food.
- Use the accessories supplied. Additional accessories may be obtained as special accessories from specialist retailers or from the after-sales service.
Before using the oven, remove any unnecessary accessories and ovenware from the cooking compartment.
- Always use oven gloves when taking hot accessories or ovenware out of the cooking compartment.

Cakes and pastries

Baking tins

It is best to use dark-coloured metal baking tins.

Baking times are increased when light-coloured baking tins made of thin metal or glass dishes are used, and cakes do not brown so evenly.

If you wish to use silicone baking tins, use the information and recipes provided by the manufacturer as a guide. Silicone baking tins are often smaller than normal tins. The amount of mixture and recipe instructions may differ.

Tables





The tables show the ideal type of heating for the various cakes and pastries. The temperature and baking time depend on the amount and composition of the mixture. This is why temperature ranges are given in the tables. You should try the lower temperature first, since a lower temperature results in more even browning. You can increase the temperature next time if necessary.

If you preheat the oven, the baking time is shortened by 5 to 10 minutes.









Additional information can be found in the *Baking tips* section following the tables.







Cake in a mould	Tin	Level	Type of heating	Temperature in °C	Cooking time in minutes
Simple, dry cake	Springform cake tin with tube sheet/fruit loaf tin	2		170-190	50-60
Simple, dry cake, delicate	Springform cake tin with tube sheet/fruit loaf tin	2		150-170	60-70
Sponge flan base	Flan-base cake tin	2		150-170	20-30

* Allow cakes to cool in the appliance for approx. 20 minutes.

Cake in a mould	Tin	Level	Type of heating	Temperature in °C	Cooking time in minutes
Fruit flan, simple dough	High springform cake tin with tube sheet	2		160-180	50-60
Sponge cake	Springform cake tin	2		160-180	30-40
Sponge flan base	Springform cake tin	1		170-190	25-35
Fruit tart or cheesecake, shortcrust pastry*	Springform cake tin	1		170-190	70-90
Spice cake*	Springform cake tin	1		180-200	50-60

* Allow cakes to cool in the appliance for approx. 20 minutes.



Cakes on trays	Accessories	Level	Type of heating	Temperature in °C	Cooking time in minutes
Sponge mixture or yeast dough with dry topping	Baking tray	2		170-190	20-30
Sponge mixture or yeast dough with moist topping, fruit	Baking tray	3		170-190	40-50
Swiss roll (preheat)	Baking tray	2		190-210	15-20
Plaited loaf with 500 g flour	Baking tray	2		160-180	30-40
Stollen with 500 g flour	Baking tray	3		160-180	60-70
Stollen with 1 kg flour	Baking tray	3		150-170	90-100
Strudel, sweet	Baking tray	2		180-200	55-65
Börek	Baking tray	2		180-200	40-50
Pizza	Baking tray	2		220-240	25-35

Small baked products	Accessories	Level	Type of heating	Temperature in °C	Cooking time in minutes
Biscuits	Baking sheet	3		150-170	10-20
Viennese whirls (preheat)	Baking sheet	2		150-170	20-30
Almond biscuits	Baking sheet	3		110-120	30-40
Meringue	Baking sheet	3		80-100	90-180
Choux pastry	Baking sheet	2		200-220	30-40
Puff pastry	Baking sheet	3		200-220	20-30

Bread and rolls

When baking bread, preheat the oven, unless instructions state otherwise.

Never pour water into the hot oven.

Bread and rolls	Accessories	Level	Type of heating	Temperature in °C	Cooking time in minutes
Yeast bread with 1.2 kg flour	Baking tray	2		270	8
				200	35-45
Sourdough bread with 1.2 kg flour	Baking tray	2		270	8
				200	40-50
Bread rolls, e.g. rye bread rolls(do not preheat)	Baking tray	4		200-220	20-30

Baking tips

You want to bake according to your own recipe.	Use similar items in the baking tables as a guide.
How to tell whether sponge cake is baked through.	Approximately 10 minutes before the end of the baking time specified in the recipe, stick a cocktail stick into the cake at the highest point. If the cocktail stick comes out clean, the cake is ready.
The cake collapses.	Use less fluid next time or set the oven temperature 10 degrees lower. Observe the specified mixing times in the recipe.
The cake has risen in the middle but is lower around the edge.	Do not grease the sides of the springform cake tin. After baking, loosen the cake carefully with a knife.
The cake goes too dark on top.	Place it lower in the oven, select a lower temperature and bake the cake for a little longer.
The cake is too dry.	When it is done, make small holes in the cake using a cocktail stick. Then drizzle fruit juice or an alcoholic beverage over it. Next time, select a temperature 10 degrees higher and reduce the baking time.
The bread or cake (e.g. cheesecake) looks good, but is soggy on the inside (sticky, streaked with water).	Use slightly less fluid next time and bake for slightly longer at a lower temperature. For cakes with a moist topping, bake the base first. Sprinkle it with almonds or bread crumbs and then place the topping on top. Follow the recipe and baking times.
The cake is unevenly browned.	Select a slightly lower temperature to ensure that the cake is baked more evenly. Bake delicate pastries on one level using  Top/bottom heating. Protruding greaseproof paper can affect the air circulation. For this reason, always cut greaseproof paper to fit the baking tray.
The bottom of a fruit cake is too light.	Place the cake one level lower the next time.
The fruit juice overflows.	Next time, use the deeper universal pan, if you have one.
Small baked products made out of yeast dough stick to one another when baking.	There should be a gap of approx. 2 cm around each item. This gives enough space for the baked items to expand well and brown on all sides.
Condensation forms when you bake moist cakes.	Baking may result in the formation of water vapour, which escapes above the door. The steam may settle and form water droplets on the control panel or on the fronts of adjacent units. This is a natural process.

Meat, poultry, fish

Ovenware

You may use any heat-resistant ovenware. The baking tray is also suitable for large roasts.

Glass ovenware is the most suitable. The lid of the roasting dish should fit well and close properly.

Add a little more liquid when using enamelled roasting dishes.

With roasting dishes made of stainless steel, browning is not so intense and the meat may be somewhat less well done.

Increase the cooking times.

Information in the tables:

Ovenware without a lid = uncovered

Ovenware with a lid = covered

Always place the ovenware in the centre of the wire rack.

Place hot glass ovenware on a dry mat after cooking. The glass could crack if placed on a cold or wet surface.

Roasting

Add in a little liquid if the meat is lean. Cover the base of the ovenware with approx. ½ cm of liquid.

Add liquid generously for pot roasts. Cover the base of the ovenware with approx. 1 - 2 cm of liquid.

The amount of liquid depends on the type of meat and the material the ovenware is made of. If preparing meat in an enamelled roasting dish, it will need a little more liquid than if cooked in glass ovenware.

Roasting dishes made from stainless steel are not ideal. The meat cooks more slowly and browns less fully. Use a higher temperature and/or a longer cooking time.

Tips for grilling

When grilling, preheat the oven for approx. 3 minutes, before placing the food into the cooking compartment.

Always grill with the oven door closed.

As far as possible, the pieces of food you are grilling should be of equal thickness. This will allow them to brown evenly and remain succulent and juicy.

Turn the food you are grilling after ⅔ of the time.

Do not add salt to steaks until they have been grilled.

Place the food to be grilled directly on the wire rack. If you are grilling a single piece, the best results are achieved by placing it in the centre of the wire rack.

Also insert the baking tray at level 1. The meat juices are collected in the pan and the oven is kept cleaner.

When grilling, do not insert the baking tray or universal pan at level 4 or 5. The high heat distorts it and the cooking compartment can be damaged when removing it.

The grill element switches on and off continually. This is normal. The grill setting determines how frequently this will happen.















Meat

Turn pieces of meat halfway through the cooking time.

When the roast is ready, turn off the oven and allow it to rest for an additional 10 minutes. This allows better distribution of the meat juices.

After cooking, wrap sirloin in aluminium foil and leave it to rest for 10 minutes in the oven.

For roast pork with a rind, score the rind in a crossways pattern, then lay the roast in the dish with the rind at the bottom.

Meat	Weight	Accessories and cookware	Height	Type of heating	Temperature in °C, grill setting	Cooking time in minutes
Beef						
Joint of beef	1.0 kg	Covered	2		200 - 220	120
	1.5 kg		2		190 - 210	140
	2.0 kg		2		180 - 200	160
Fillet of beef	1.0 kg	Uncovered	2		210 - 230	70
	1.5 kg		2		200 - 220	80
	2.0 kg		2		190 - 210	90
Sirloin, medium	1.0 kg	Uncovered	2		210 - 230	60
Steaks, well-done		Wire rack	5		3	20
Steaks, medium, 3 cm thick		Wire rack	5		3	15
Veal						
Joint of veal	1.0 kg	Uncovered	2		190 - 210	110
	2.0 kg		2		170 - 190	120
Lamb						
Leg of lamb, boned, medium	1.5 kg	Uncovered	2		170 - 190	120
Minced meat						
Meat loaf	Made from 750 g meat	Uncovered	2		200 - 220	70
Sausages						
Sausages	Approx. 750 g	Wire rack	4		3	15

Poultry

The weights indicated in the table refer to oven-ready poultry (without stuffing).







Place whole poultry on the lower wire rack breast-side down. Turn after $\frac{2}{3}$ of the specified time.

Turn roasts, such as rolled turkey joint or turkey breast, halfway through the cooking time. Turn poultry portions after $\frac{2}{3}$ of the time.

For duck or goose, pierce the skin on the underside of the wings. This allows the fat to run out.

Poultry will turn out particularly crispy and brown if you baste it towards the end of the roasting time with butter, salted water or orange juice.

If you are grilling directly on the wire rack, you should insert the baking tray at level 1. The meat juices are collected in the pan and the oven is kept cleaner.

Poultry	Weight	Accessories and ovenware	Level	Type of heating	Temperature in °C	Cooking time in minutes
Chicken, half	400 g each	Wire rack	2		210-230	50-60
Chicken pieces	250 g each	Wire rack	2		210-230	30-40
Chicken, whole	1.0 kg	Wire rack	2		210-230	60-80
Duck, whole	1.7 kg	Wire rack	2		200-220	90-100
Goose, whole	3.0 kg	Wire rack	2		190-210	100-120
Small turkey, whole	3.0 kg	Wire rack	2		200-220	80-100
2 turkey drumsticks	800 g each	Wire rack	2		200-220	100-120





Fish

Turn the pieces of fish after $\frac{2}{3}$ of the grilling time.

Whole fish does not have to be turned. Place the whole fish in the oven in its swimming position with its dorsal fin facing

upwards. Placing half a potato or a small ovenproof container in the belly of the fish will make it more stable.

If you are grilling directly on the wire rack, you should also insert the baking tray at level 1. The liquid is then collected, keeping the oven cleaner.

Fish	Weight	Accessories and ovenware	Level	Type of heating	Temperature in °C, grill setting	Cooking time in minutes
Fish, whole	300 g each	Wire rack	3		2	20-25
	1.0 kg	Wire rack	2		190-210	45-50
	1.5 kg	Wire rack	2		180-200	50-60
Fish fillet, 3 cm	300 g each	Wire rack	4		2	20-25

Tips for roasting and grilling





The table does not contain information for the weight of the joint.	Select the next lowest weight from the instructions and extend the time.
How to tell when the roast is ready.	Use a meat thermometer (available from specialist shops) or carry out a "spoon test". Press down on the roast with a spoon. If it feels firm, it is ready. If the spoon can be pressed in, it needs to be cooked for a little longer.
The roast is too dark and the crackling is partly burnt.	Check the shelf height and temperature.
The roast looks good but the juices are burnt.	Next time, use a smaller roasting dish or add more liquid.
The roast looks good but the juices are too clear and watery.	Next time, use a larger roasting dish and use less liquid.
Steam rises from the roast when basted.	This is normal and due to the laws of physics. The majority of the steam escapes through the steam outlet. It may settle and form condensation on the cooler switch panel or on the fronts of adjacent units.

Bakes, gratins, toast with toppings

If you are grilling directly on the wire rack, you should also insert the baking tray at level 1. This keeps the oven cleaner.

Always place the ovenware on the wire rack.

How well cooked the bake is will depend on the size of the dish and the height of the bake. The figures in the table are only average values.





Dish	Accessories and ovenware	Level	Type of heating	Temperature °C, grill setting	Cooking time in minutes
Bakes					
Bake, sweet	Ovenproof dish	2		180-200	40-50
Pasta bake	Ovenproof dish	2		210-230	30-40
Gratin					
Potato gratin made using raw ingredients, Max. 4 cm deep	Ovenproof dish	2		160-180	50-60
Toast					
Toasts browned from above 12 pieces	Wire rack	4		3	5-8

Preprepared products

Observe the instructions on the packaging.

If you line the accessories with greaseproof paper, make sure that the paper is suitable for these temperatures. Make sure the paper is a suitable size for the dish to be cooked.

The cooking result greatly depends on the quality of the food. Pre-browning and irregularities can sometimes even be found on the raw product.

Dish	Accessories	Level	Type of heating	Temperature in °C	Cooking time in minutes
Strudel, frozen	Baking sheet	3		200-220	30-40
Chips	Baking sheet	3		190-210	25-30
Pizza	Wire rack	2		200-220	15-20
Pizza baguette	Wire rack	3		200-220	20-25

Special dishes

Low temperatures are particularly good for preparing yeast dough and home-made yoghurt.

Remove the accessories from the oven.

Preparing yoghurt

1. Bring 1 litre of milk (3.5% fat) to the boil, let it cool to 40 °C.
2. Add 150 g yoghurt (from the refrigerator) to the milk and stir well.
3. Pour into small sealable jars and cover with cling film.

Dish	Ovenware	Type of heating	Temperature	Cooking time
Yoghurt	Sealable yoghurt jars	☐	50 °C	6-8 hours
Proving yeast dough	Place the heat-resistant dish	☐	preheat to 50 °C Switch off the appliance and place the yeast dough in the oven	5-10 minutes 20-30 minutes

Preserving

For preserving, the jars and rubber seals must be clean and intact. If possible, use jars of the same size. The information in the table is for round, one-litre jars.

Caution!

Do not use jars that are larger or taller than this. The lids could crack.

Only use fruit and vegetables in good condition. Wash them thoroughly.

The times given in the tables are a guide only. The time will depend on the room temperature, number of jars, and the quantity and temperature of the contents. Before you switch off the appliance or change the cooking mode, check whether the contents of the jars are bubbling as they should.

Preparation

1. Fill the jars, but not to the top.
2. Wipe the rims of the jars, as they must be clean.
3. Place a damp rubber seal and a lid on each jar.

Fruit in one-litre jars	When it starts to bubble	Residual heat
Apples, redcurrants, strawberries	Switch off	approx. 25 minutes
Cherries, apricots, peaches, gooseberries	Switch off	approx. 30 minutes
Apple purée, pears, plums	Switch off	approx. 35 minutes

Vegetables

As soon as bubbles begin to form in the jars, set the temperature back to between 120 and 140 °C. Depending on

Vegetables with cold cooking water in one-litre jars	When it starts to bubble	Residual heat
Gherkins	-	approx. 35 minutes
Beetroot	approx. 35 minutes	approx. 30 minutes
Brussels sprouts	approx. 45 minutes	approx. 30 minutes
Beans, kohlrabi, red cabbage	approx. 60 minutes	approx. 30 minutes
Peas	approx. 70 minutes	approx. 30 minutes

Taking out the jars

After preserving, remove the jars from the cooking compartment.

Caution!

Do not place the hot jars on a cold or wet surface. They could suddenly burst.

4. Place the jars on a wire rack and slide in at level 1.
5. Set the baking temperature to 50 °C and continue as indicated.

Proving yeast dough

1. Prepare the yeast dough as usual, place it in a heat-resistant ceramic dish and cover with a lid.
2. Preheat the oven as indicated.
3. Close the oven door and allow the yeast dough to prove in the oven.

4. Seal the jars with the clips.

Place no more than six jars in the cooking compartment.

Making settings

1. Insert the universal pan at level 2. Arrange the jars on it so that they do not touch each other.
2. Pour ½ litre of hot water (approx. 80 °C) into the universal pan.
3. Close the oven door.
4. Set ☐ Bottom heating.
5. Set the temperature to between 170 and 180 °C.

Preserving

Fruit

After approx. 40 to 50 minutes, small bubbles begin to form at short intervals. Switch off the oven.

After 25 to 35 minutes of residual heat, remove the preserving jars from the cooking compartment. If they are allowed to cool for longer in the cooking compartment, germs could multiply, promoting acidification of the preserved fruit.

the type of vegetable, heat for approx. 35 to 70 minutes. Switch off the oven after this time and use the residual heat.

Acrylamide in foodstuffs

Acrylamide is mainly produced in grain and potato products prepared at high temperatures, such as potato crisps, chips,

toast, bread rolls, bread or fine baked goods (biscuits, gingerbread, cookies).

Tips for keeping acrylamide to a minimum when preparing food

General	<ul style="list-style-type: none"> ■ Keep cooking times to a minimum. ■ Cook meals until they are golden brown, but not too dark. ■ Large, thick pieces of food contain less acrylamide.
Baking	<p>With top/bottom heating max. 200 °C. With 3D hot air or hot air max. 180 °C.</p>
Biscuits	<p>With top/bottom heating max. 190 °C. With 3D hot air or hot air max. 170 °C. Egg or egg yolk reduces the production of acrylamide.</p>
Oven chips	<p>Spread evenly over the baking tray, in a single layer. Bake at least 400 g per baking tray so that the chips do not dry out</p>

Test dishes

These tables have been produced for test institutes to facilitate the inspection and testing of the various appliances.





In accordance with EN 50304/EN 60350 (2009) and IEC 60350.

Baking

For apple pie, place the dark springform cake tins diagonally next to each other.



Cakes in tinplate springform cake tins:

Bake on 1 level with  Top/bottom heating Place the springform cake tins on the baking tray instead of directly on the wire rack.

Dish	Accessories and oven-ware	Level	Type of heating	Temperature in °C	Cooking time in minutes
Viennese whirls	Baking tray	2		150-170	20-30
Small cakes, 20 cakes	Baking tray	3		160-180	20-30
Hot water sponge cake	Springform cake tin on the wire rack	2		160-180	30-40
Apple pie	Wire rack + 2 springform cake tins, dia. 20 cm	1		190-210	70-80

Grilling

If you are grilling food directly on the wire rack, the baking tray should also be inserted at level 1. The liquid is then collected, keeping the oven cleaner.

Dish	Accessories and oven-ware	Level	Type of heating	Grill setting	Cooking time in minutes
Toast Preheat for 10 minutes	Wire rack	5		3	1-2
Beefburgers, x12* do not preheat	Wire rack + baking tray	4		3	25-30

* turn over after $\frac{2}{3}$ of the cooking time.





Robert Bosch Hausgeräte GmbH

Carl-Wery-Straße 34

81739 München

Germany

www.bosch-home.com



9001147329

01
270895