

manual de instrucciones

3ETG663., 3ETG664., 3ETG67...

Βάση εστιών αερίου

Placa de cocción a gas

Placa de cozinhar a gás

Ankastre Gazli Ocak

[el] ΟΔΗΓΙΕΣ ΧΡΗΣΗΣ	3
[es] INSTRUCCIONES DE USO	13
[pt] INSTRUÇÕES DE SERVIÇO	22
[tr] KULLANMA KILAVUZU	31

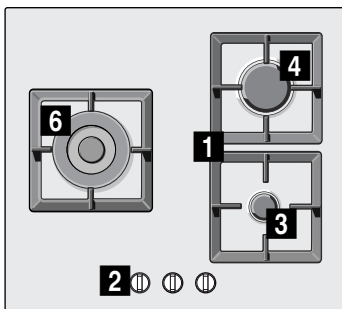
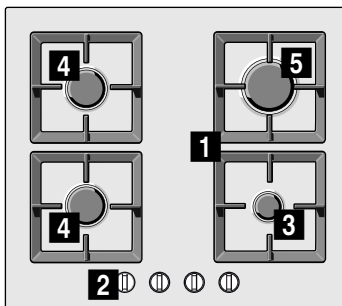
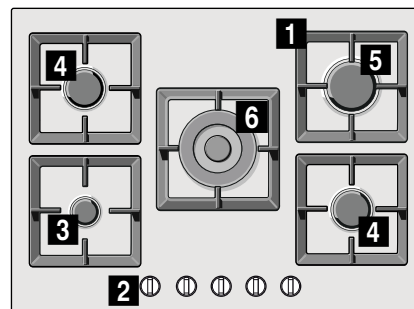
3ETG663..**3ETG664..****3ETG676..**

- 1** Σχάρες
- 2** Διακόπτες
- 3** Οικονομικός καυστήρας μέχρι και 1 kW

- 4** Κανονικός καυστήρας μέχρι και 1,75 kW
- 5** Ισχυρός καυστήρας μέχρι και 3 kW
- 6** Καυστήρας για Wok μέχρι και 4 kW

- 1** Parrillas
- 2** Mandos
- 3** Quemador auxiliar de hasta 1 kW

- 4** Quemador semi-rápido de hasta 1,75 kW
- 5** Quemador rápido de hasta 3 kW
- 6** Quemador wok de hasta 4 kW









- 1** Grelhas
- 2** Comandos
- 3** Queimador económico com até 1 kW

- 4** Queimador normal com até 1,75 kW
- 5** Queimador rápido com até 3 kW
- 6** Queimador wok com até 4 kW

- 1** Izgaralar
- 2** Kumanda düğmeleri
- 3** Ekonomik brülör, maksimum 1 kW

- 4** Normal brülör, maksimum 1,75 kW
- 5** Güçlü brülör, maksimum 3 kW
- 6** 4 kW'a kadar olan wok brülör

Πίνακας περιεχομένων

	Χρήση σύμφωνα με το σκοπό προορισμού	3
	Σημαντικές υποδείξεις ασφαλείας	4
	Γνωρίστε τη συσκευή	6
	Στοιχεία χειρισμού και καυστήρες	6
	Καυστήρες αερίου	6
	Χειροκίνητη ενεργοποίηση	6
	Αυτόματη ανάφλεξη	6
	Σύστημα ασφαλείας	6
	Σβήσιμο ενός καυστήρα	6
	Προειδοποιήσεις	7
	Πίνακες και συμβουλές	7
	Κατάλληλα σκεύη	7
	Υποδείξεις χρήσης	7
	Πίνακας μαγειρέματος	7
	Καθαρισμός και συντήρηση	10
	Καθαρισμός	10
	Συντήρηση	10
	Βλάβες, τι μπορεί να γίνει;	11
	Υπηρεσία εξυπηρέτησης πελατών	12
	Όροι εγγύησης	12
	Προστασία περιβάλλοντος	12
	Απόσυρση σύμφωνα με τους κανόνες προστασίας του περιβάλλοντος	12

Χρήση σύμφωνα με το σκοπό προορισμού

Διαβάστε προσεκτικά τις οδηγίες. Μόνο τότε θα μπορείτε να χειριστείτε τη συσκευή σας αποτελεσματικά και με ασφάλεια. Κρατήστε της οδηγίες χρήσης και εγκατάστασης, και παραδώστε τις οδηγίες αυτές μαζί με τη συσκευή σε κάποιο μελλοντικό ιδιοκτήτη.

Ο κατασκευαστής δεν φέρει καμία ευθύνη αν δεν ακολουθηθούν οι οδηγίες του παρόντος εγχειριδίου.

Οι εικόνες που υπάρχουν σ'αυτές τις οδηγίες είναι μόνο ενδεικτικές.

Μην βγάζετε τη συσκευή από το προστατευτικό περιτύλιγμα μέχρι τη στιγμή της εντοίχισης. Εάν παρατηρήσετε κάποια βλάβη στη συσκευή, μην τη συνδέετε. Επικοινωνήστε με το τεχνικό μας σέρβις.

Αυτή η συσκευή αντιστοιχεί στην κατηγορία 3, σύμφωνα με τον κανονισμό EN 30-1-1 για συσκευές αερίου: συσκευή εντοιχισμένη σε έπιπλο.

Πριν εγκαταστήσετε τη νέα βάση εστιών σας, βεβαιωθείτε ότι κάνετε την εγκατάσταση ακολουθώντας της οδηγίες συναρμολόγησης.

Δεν μπορεί να γίνει εγκατάσταση αυτής της συσκευής σε γιωτ ή τροχόσπιτα.

Η συσκευή αυτή πρέπει να χρησιμοποιείται μόνο σε αεριζόμενους χώρους.

Αυτή η συσκευή δεν προορίζεται για τη λειτουργία με έναν εξωτερικό χρονοδιακόπτη ή ένα τηλεχειριστήριο.

Όλες οι εργασίες εγκατάστασης, σύνδεσης, ρύθμισης και προσαρμογής σε άλλους τύπους αερίου θα πρέπει να γίνουν από εξουσιοδοτημένο τεχνικό, σύμφωνα με την ισχύουσα ρύθμιση και νομοθεσία, και τους κανονισμούς των τοπικών εταιριών διανομής ηλεκτρικού και αερίου. Ιδιαίτερη έμφαση πρέπει να δοθεί στις διατάξεις που εφαρμόζονται σχετικά με τον αερισμό.

Αυτή η συσκευή βγαίνει από το εργοστάσιο με προσαρμοσμένο το αέριο που ορίζεται στην ετικέτα χαρακτηριστικών. Εάν είναι απαραίτητο να το αλλάξετε, συμβουλευτείτε τις οδηγίες συναρμολόγησης. Συνίσταται να επικοινωνήσετε με το τεχνικό σέρβις για την προσαρμογή σε άλλους τύπους αερίου.

Αυτή η συσκευή έχει σχεδιαστεί μόνο για οικιακή χρήση, απαγορεύεται η εμπορική ή επαγγελματική χρήση της. Χρησιμοποιήστε τη συσκευή αποκλειστικά για μαγειρική, ποτέ ως θέρμανση. Η εγγύηση ισχύει μόνο εφόσον η συσκευή χρησιμοποιείται για τον λόγο που έχει σχεδιαστεί.

Αυτή η συσκευή προορίζεται για χρήση μέχρι ένα μέγιστο ύψος 2.000 μέτρων πάνω από την επιφάνεια της θάλασσας.

Μην αφήσετε τη συσκευή κατά τη διάρκεια της λειτουργίας χωρίς επιτήρηση.

Μην χρησιμοποιείτε καλύμματα ή προστατευτικά εμπόδια για παιδιά που δεν συνιστανται από τον κατασκευαστή της βάσης εστιών. Μπορεί να προκαλέσουν ατυχήματα, π.χ. λόγω υπερθέρμανσης, ανάφλεξης ή αποκόλλησης θραυσμάτων υλικών.

Αυτή η συσκευή επιτρέπεται να χρησιμοποιηθεί από παιδιά από 8 ετών και πάνω και από άτομα με μειωμένες φυσικές, αισθητήριες ή πνευματικές ικανότητες ή με ανεπαρκή εμπειρία ή γνώση, όταν επιτηρούνται από ένα άτομο που είναι υπεύθυνο για την ασφάλειά τους ή έχουν λάβει σχετικές οδηγίες απ' αυτό για την ασφαλή χρήση της συσκευής και έχουν κατανοήσει τους κινδύνους που μπορεί να προκύψουν.

Τα παιδιά δεν επιτρέπεται να παίζουν με τη συσκευή. Ο καθαρισμός και η συντήρηση από το χρήστη δεν επιτρέπεται να πραγματοποιηθούν από παιδιά, εκτός εάν είναι 15 ετών και άνω και επιτηρούνται.

Κρατάτε τα παιδιά που είναι κάτω των 8 ετών μακριά από τη συσκευή και το καλώδιο σύνδεσης.

Σημαντικές υποδείξεις ασφαλείας

Προειδοποίηση – Κίνδυνος κατάκαυσης!

Η συσσώρευση αερίου χωρίς να καίγεται σε ένα κλειστό χώρο εγκυμονεί κίνδυνο κατάκαυσης. Μην τοποθετείτε τη συσκευή κοντά σε ρεύμα αέρα. Οι καυστήρες μπορεί να σβήσουν. Διαβάστε με προσοχή τις οδηγίες και τις προειδοποιήσεις σχετικά με τη λειτουργία των καυστήρων αερίου.

Προειδοποίηση – Κίνδυνος δηλητηρίασης!

Η χρήση μιας συσκευής αερίου παράγει θερμότητα, υγρασία και προϊόντα καύσης στο μέρος που εγκαθίσταται. Διασφαλίστε ένα καλό εξαερισμό στο χώρο της κουζίνας, ειδικά ενώ λειτουργεί η βάση εστιών: να διατηρείτε ανοιχτά τα ανοίγματα φυσικού εξαερισμού, ή εγκαταστήστε μια συσκευή μηχανικού εξαερισμού (απορροφητήρας). Η έντονη και παρατεταμένη χρήση της συσκευής μπορεί να χρειάζεται ένα συμπληρωματικό ή ένα πιο αποτελεσματικό σύστημα εξαερισμού. ανοίξτε το παράθυρο ή αυξήστε την ισχύ του μηχανικού εξαερισμού.

Προειδοποίηση – Κίνδυνος εγκαυμάτων!

- Οι εστίες και τα κοντινά στοιχεία θερμαίνονται πολύ. Ποτέ μην αγγίζετε τις θερμές επιφάνειες. Μακριά από παιδιά κάτω των 8 χρονών.
- Εάν η μπουκάλα υγραερίου δεν στέκεται κάθετα, μπορεί να εισχωρήσει υγρό προπάνιο/βουτάνιο στη συσκευή. Σε αυτή την περίπτωση μπορούν να προκύψουν μεγάλες φλόγες στους καυστήρες. Τα εξαρτήματα μπορούν να υποστούν ζημιά και με την πάροδο του χρόνου να εμφανιστεί μια διαρροή, έτσι ώστε να εξέρχεται αέριο μη ελεγχόμενα. Και οι δύο περιπτώσεις μπορεί να οδηγήσουν σε τραυματισμούς. Χρησιμοποιείτε τις μπουκάλες υγραερίου πάντοτε σε κάθετη θέση.

Προειδοποίηση – Κίνδυνος πυρκαγιάς!

- Οι εστίες θερμαίνονται πολύ. Μην τοποθετείτε εύφλεκτα αντικείμενα πάνω στη βάση εστιών. Μην αποθηκεύετε αντικείμενα πάνω στη βάση εστιών.

- Μην αποθηκεύετε και μην χρησιμοποιείτε διαβρωτικές χημικές ουσίες, ατμούς, εύφλεκτα υλικά ή μη εδώδιμα προϊόντα, κάτω από αυτή την οικιακή συσκευή ή κοντά της.
- Τα υπερθερμαινόμενα λίπη και λάδια αναφλέγονται πολύ εύκολα. Μην απουσιάζετε ενώ ζεσταίνεται λίπος ή λάδι. Σε περίπτωση ανάφλεξης, μην σβήσετε τη φωτιά με νερό. Καλύψτε το σκεύος με ένα καπάκι για να συγκρατήσετε τη φωτιά και σβήστε την εστιά.

⚠ Προειδοποίηση – Κίνδυνος τραυματισμού!

- Οι ρωγμές ή οι θραύσεις στη γυάλινη πλάκα είναι επικίνδυνες. Απενεργοποιήστε αμέσως όλους τους καυστήρες και κάθε ηλεκτρικό θερμαντικό στοιχείο. Τραβήξτε το φισ από την πρίζα ή κατεβάστε την ασφάλεια στο κιβώτιο των ασφαλειών. Κλείστε την παροχή αερίου. Μην ακουμπήσετε την επιφάνεια της συσκευής. Μην ενεργοποιείτε ποτέ μια χαλασμένη συσκευή. Καλέστε την υπηρεσία εξυπηρέτησης πελατών.
- Οι απότομες αλλαγές θερμοκρασίας μπορεί να ραγίζουν το κρύσταλλο. Αποφύγετε τα ρεύματα αέρα και το χύσιμο κρύων υγρών κατά τη διάρκεια της χρήσης της βάσης εστιών.
- Τα σκεύη που παρουσιάζουν βλάβες, δεν έχουν το κατάλληλο μέγεθος, προεξέχουν από τις άκρες της βάσης εστιών ή δεν είναι τοποθετημένα σωστά μπορεί να προκαλέσουν σοβαρούς τραυματισμούς. Διαβάστε με προσοχή τις συμβουλές και προειδοποιήσεις σχετικά με τα σκεύη μαγειρικής.
- Οι ακατάλληλες επισκευές είναι επικίνδυνες. Μόνο ένας τεχνικός του τμήματος εξυπηρέτησης πελατών, εκπαιδευμένος από εμάς, επιτρέπεται να εκτελέσει τις επισκευές και να αντικαταστήσει τα χαλασμένα ηλεκτρικά καλώδια και τους σωλήνες παροχής αερίου. Εάν η συσκευή έχει βλάβη, τραβήξτε το ρευματολήπτη (φισ) από την πρίζα ή κατεβάστε/ξεβιδώστε την αντίστοιχη ασφάλεια στο κιβώτιο των ασφαλειών, κλείστε την παροχή αερίου. Καλέστε την υπηρεσία τεχνικής εξυπηρέτησης πελατών.
- Όταν ένα κουμπί χειρισμού δεν μπορεί να περιστραφεί ή είναι χαλαρό, δεν επιτρέπεται πλέον να χρησιμοποιηθεί. Επικοινωνήστε αμέσως με την υπηρεσία εξυπηρέτησης πελατών, για να επισκευαστεί ή να αντικατασταθεί το κουμπί χειρισμού.

⚠ Προειδοποίηση – Κίνδυνος βραχυκυκλώματος!

- Μην χρησιμοποιείτε συσκευές καθαρισμού με ατμό για να καθαρίσετε τη συσκευή.
- Ρωγμές ή θραύσεις στη γυάλινη πλάκα μπορούν να προκαλέσουν ηλεκτροπληξία. Κατεβάστε την ασφάλεια στο κιβώτιο των ασφαλειών. Καλέστε την υπηρεσία τεχνικής εξυπηρέτησης πελατών.

Γνωρίστε τη συσκευή

Στην επισκόπηση των μοντέλων θα βρείτε τη συσκευή σας με τις βαθμίδες ισχύος των καυστήρων. → Σελίδα 2

Στοιχεία χειρισμού και καυστήρες

Σε κάθε διακόπτη χειρισμού είναι μαρκαρισμένος ο αντίστοιχος καυστήρας. Με τους διακόπτες χειρισμού μπορείτε να ρυθμίσετε, σύμφωνα με τις διάφορες θέσεις, την εκάστοτε απαραίτητη ισχύ μεταξύ των μέγιστων και των ελάχιστων τιμών. Μη δοκιμάσετε ποτέ, να περάσετε από τη θέση 0 απευθείας στη θέση 1 ή από τη θέση 1 στη θέση 0.

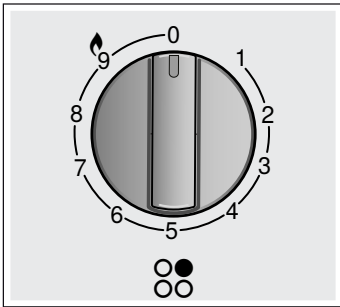

Ενδείξεις	
	Καυστήρας ελεγχόμενος με το διακόπτη χειρισμού
0	Απενεργοποιημένος καυστήρας
9	Υψηλότερη βαθμίδα ισχύος και ηλεκτρική ανάφλεξη
1	Χαμηλότερη βαθμίδα ισχύος

Για την καλή λειτουργία της συσκευής είναι απαραίτητο να βεβαιωθείτε ότι οι σχάρες, καθώς και όλα τα κομμάτια, έχουν τοποθετηθεί σωστά. Μην ανταλλάζετε τα καπάκια των καυστήρων.

Αφαιρείτε τις σχάρες πάντοτε προσεκτικά. Η μετατόπιση μιας σχάρας μπορεί να μετακινήσει επίσης και τις γειτονικές σχάρες.

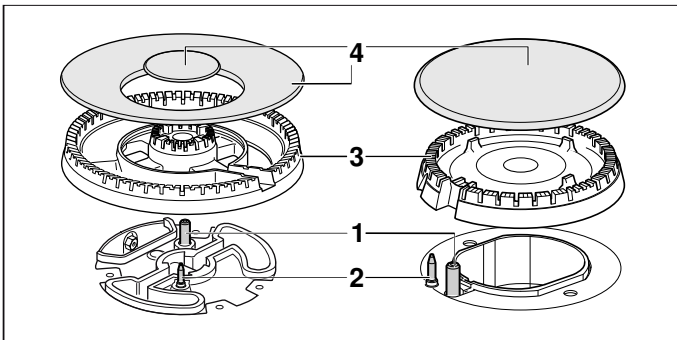

Στοιχεία	
1	Αναφλεκτήρας
2	Θερμοστοιχείο
3	Κεφαλή καυστήρα
4	Καπάκι καυστήρα

Καυστήρες αερίου

Χειροκίνητη ενεργοποίηση

1. Πατήστε το διακόπτη χειρισμού του επιλεγμένου καυστήρα και γυρίστε το προς τα αριστερά, μέχρι την υψηλότερη βαθμίδα ισχύος.
2. Κρατήστε έναν αναφλεκτήρα ή μια φλόγα (αναπήρας, σπρίτο κτλ.) κοντά στον καυστήρα.

Αυτόματη ανάφλεξη

Όταν η βάση εστιών διαθέτει μια αυτόματη ανάφλεξη (αναφλεκτήρες):

1. Πατήστε το διακόπτη χειρισμού του επιλεγμένου καυστήρα και γυρίστε το προς τα αριστερά, μέχρι την υψηλότερη βαθμίδα ισχύος. Κατά τη διάρκεια που κρατάτε πατημένο το διακόπτη χειρισμού, δημιουργούνται σ' όλους τους καυστήρες σπινθήρες. Ο καυστήρας ανάβει.
2. Αφήστε το διακόπτη χειρισμού ελεύθερο.
3. Γυρίστε το διακόπτη χειρισμού στην επιθυμητή θέση.

Εάν δεν πραγματοποιηθεί καμία ανάφλεξη, ενεργοποιήστε τον καυστήρα και επαναλάβετε τα βήματα που περιγράφονται προηγουμένως. Αυτή την φορά κρατήστε το διακόπτη χειρισμού περισσότερο χρόνο πατημένο (μέχρι και 10 δευτερόλεπτα).

Προειδοποίηση – Κίνδυνος εκρηκτικής ανάφλεξης!

Εάν ο καυστήρας δεν ανάψει μετά από 15 δευτερόλεπτα, κλείστε το διακόπτη χειρισμού και ανοίξτε την πόρτα ή το παράθυρο του δωματίου. Περιμένετε το λιγότερο ένα λεπτό, προτού ανάψετε ξανά τον καυστήρα.

Υπόδειξη: Προσέξτε για πολύ μεγάλη καθαριότητα. Εάν οι αναφλεκτήρες είναι λερωμένοι, μπορεί να προκύψει μια ελαττωματική ανάφλεξη. Καθαρίζετε τακτικά τους αναφλεκτήρες με μια μικρή, μη μεταλλική βούρτσα. Προσέξτε, να μην ασκηθούν δυνατοί κραδασμοί στους αναφλεκτήρες.

Σύστημα ασφαλείας

Η βάση εστιών σας διαθέτει ένα σύστημα ασφαλείας (θερμοστοιχείο) που εμποδίζει τη διέλευση του αερίου αν οι καυστήρες σβήσουν τυχαία.

Για να βεβαιωθείτε ότι η συσκευή αυτή είναι ενεργή:

1. Ανάψτε τον καυστήρα φυσιολογικά.
2. Χωρίς να αφήσετε το διακόπτη, κρατήστε τον πατημένο σταθερά για 4 δευτερόλεπτα μετά το άναμμα της φλόγας.

Σβήσιμο ενός καυστήρα

Γυρίστε τον αντίστοιχο διακόπτη προς τα δεξιά μέχρι τη θέση 0.

Λίγα δευτερόλεπτα μετά το σβήσιμο του καυστήρα θα ακουστεί ένας ήχος (στεγνό χτύπημα). Δεν υπάρχει πρόβλημα, αυτό σημαίνει ότι η ασφάλεια έχει απενεργοποιηθεί.

Προειδοποιήσεις

Κατά τη λειτουργία του καυστήρα, είναι φυσιολογικό να ακουστεί ένα ελαφρύ σφύριγμα.

Κατά τις πρώτες χρήσεις, η εμφάνιση μυρωδιών είναι φυσιολογική. Δεν υφίσταται κανένας κίνδυνος ούτε κακή λειτουργία Θα χαθούν με τον καιρό

Είναι φυσιολογικό, η φλόγα να έχει χρώμα πορτοκαλί. Οφείλεται στη σκόνη που υπάρχει στο περιβάλλον, στην υπερχειλίση υγρών, κ.λπ.

Σε περίπτωση που οι φλόγες του καυστήρα σβήσουν τυχαία, κλείστε το διακόπτη λειτουργίας του καυστήρα και μην προσπαθείτε να τον ανάψετε για 1 λεπτό τουλάχιστον.

Πίνακες και συμβουλές

Κατάλληλα σκεύη

Καυστήρας	Ελάχιστη διάμετρος του πάτου του μαγειρικού σκεύους	Μέγιστη διάμετρος του πάτου του μαγειρικού σκεύους
Καυστήρας Wok	22 cm	30 cm
Ισχυρός καυστήρας	20 cm	26 cm
Κανονικός καυστήρας	14 cm	22 cm
Οικονομικός καυστήρας	12 cm	16 cm

Το σκεύος δεν επιτρέπεται να προεξέχει πέρα από το περιθώριο της βάσης εστιών.

Υποδείξεις χρήσης

Οι ακόλουθες προτάσεις θα σας βοηθήσουν να εξοικονομήσετε ενέργεια και να μην προκαλέσετε ζημιές στα σκεύη:

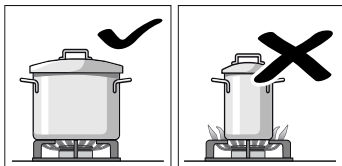

Χρησιμοποιήστε σκεύη κατάλληλου μεγέθους για κάθε καυστήρα. Να μη χρησιμοποιείτε μικρά σκεύη πάνω σε μεγάλους καυστήρες. Η φλόγα δεν πρέπει να αγγίζει τα πλευρικά τοιχώματα του σκεύους.

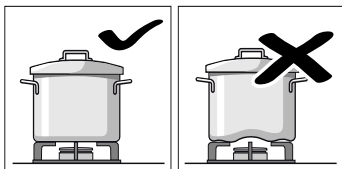

Μην χρησιμοποιείτε παραμορφωμένα σκεύη, τα οποία είναι ασταθή πάνω στην εστία. Τα σκεύη μπορεί να γείρουν.

Χρησιμοποιήστε μόνο σκεύη με βάση επίπεδη και λεία.

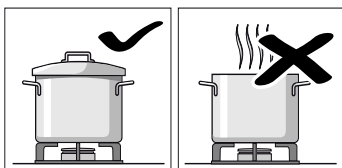

Μην μαγειρεύετε χωρίς καπάκι ή με μισοσκεπασμένο σκεύος. Χάνεται μέρος της ενέργειας.

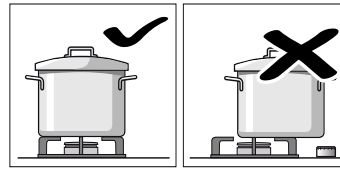

Τοποθετήστε το σκεύος καλά κεντραρισμένο πάνω στον καυστήρα. Σε αντίθετη περίπτωση μπορεί να γείρει. Μην τοποθετείτε μεγάλα σκεύη στους καυστήρες που βρίσκονται κοντά στους διακόπτες. Μπορεί να προκληθεί βλάβη λόγω υπερβολικής θερμοκρασίας.

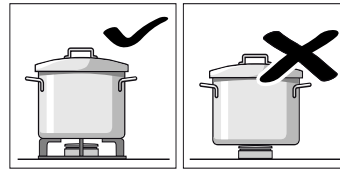

Τοποθετήστε τα σκεύη πάνω στις σχάρες, ποτέ απευθείας επάνω στον καυστήρα.

Βεβαιωθείτε πριν από τη χρήση ότι οι σχάρες και τα καλύμματα των καυστήρων είναι καλά τοποθετημένα.

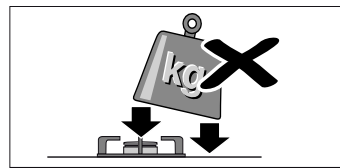

Χειριστείτε τα σκεύη με προσοχή πάνω στη βάση εστιών.

Μην χτυπάτε τη βάση εστιών, και μην τοποθετείτε πάνω της υπέρβαρα αντικείμενα.

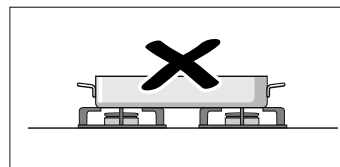

Μην χρησιμοποιείτε δυο καυστήρες ή πηγές θερμότητας μόνο για ένα σκεύος.

Αποφύγετε τη χρήση των πλακών ψησίματος, πήλινα σκεύη, κτλ. για πολύ ώρα στη μέγιστη ισχύ.

Πίνακας μαγειρέματος

Ο παρακάτω πίνακας περιέχει τις ιδανικές βαθμίδες μαγειρέματος και τους ιδανικούς χρόνους μαγειρέματος για διάφορα φαγητά. Τα στοιχεία είναι τιμές αναφοράς για τέσσερις μερίδες.

Οι χρόνοι μαγειρέματος και οι βαθμίδες μαγειρέματος εξαρτώνται από το είδος, το βάρος και την ποιότητα των φαγητών, από το είδος του χρησιμοποιούμενου αερίου καθώς και από το υλικό των μαγειρικών σκευών. Για την παρασκευή αυτών των φαγητών χρησιμοποιήθηκαν κυρίως μαγειρικά σκεύη από ανοξείδωτο χάλυβα.

Χρησιμοποιείτε πάντοτε μαγειρικά σκεύη με το αντίστοιχο μέγεθος και τοποθετείτε τα στη μέση του καυστήρα.

Πληροφορίες για τη διάμετρο του μαγειρικού σκεύους μπορείτε να βρείτε κάτω από → "Κατάλληλα σκεύη".

Πληροφορίες σχετικά με τον πίνακα







Η παρασκευή κάθε φαγητού αποτελείται από ένα ή δύο βήματα. Κάθε βήμα περιέχει πληροφορίες για τα εξής:

 Μέθοδος μαγειρέματος

 Βαθμίδα μαγειρέματος

 Διάρκεια σε λεπτά

Αναφερόμενες στον πίνακα μέθοδοι μαγειρέματος

-  Βράσιμο
-  Συνέχιση μαγειρέματος
-  Δημιουργία πίεσης στη χύτρα ταχύτητας
-  Διατήρηση της πίεσης στη χύτρα ταχύτητας
-  Δυνατό σοτάρισμα
-  Ελαφρό σοτάρισμα
-  Λιώσιμο
- * Χωρίς καπάκι
- ** Συνεχές ανακάτεμα

Υπόδειξη: Τα σύμβολα δεν εμφανίζονται στη συσκευή. Χρησιμοποιούν ως προσανατολισμός για τις διάφορες μεθόδους μαγειρέματος.

Εμφανίζονται στοιχεία για την παρασκευή φαγητών σε διαφορετικούς καυστήρες. Η συνιστούμενη επιλογή είναι ο πρώτος αναφερόμενος καυστήρας. Στην επισκόπηση των μοντέλων περιγράφονται όλοι οι καυστήρες της βάσης εστιών. → Σελίδα 2

Παράδειγμα:

Φαγητό Καυστήρας	Συνολικός χρόνος σε λεπτά	Βήμα 1			Βήμα 2		
Σούπες, σούπες κρέμα							
Ψαρόσουπα							
Ισχυρός καυστήρας	12-17		8	7-9		1	5-8
Κανονικός καυστήρας	17-22		8	11-13		1	6-9
Καυστήρας Wok	10-15		9	6-8		4	4-7

Αυτό το παράδειγμα δείχνει την παρασκευή ψαρόσουπας με τον ισχυρό καυστήρα, τον κανονικό καυστήρα και τον καυστήρα Wok.

Με τον ισχυρό καυστήρα (συνιστούμενη επιλογή) ανέρχεται ο συνολικός χρόνος μαγειρέματος μεταξύ 12 και 17 λεπτών.

- Βήμα 1: Ανάβρασμα. Για 7-9 λεπτά ρυθμίστε τη βαθμίδα μαγειρέματος 8.
- Βήμα 2: Συνέχιση μαγειρέματος. Για 5-8 λεπτά αλλάξτε στη βαθμίδα μαγειρέματος 1.

Τα στοιχεία ισχύουν επίσης και για τους άλλους προτεινόμενους καυστήρες.

Φαγητό Καυστήρας	Συνολικός χρόνος σε λεπτά	Βήμα 1			Βήμα 2		
Σούπες, σούπες κρέμα							
Ψαρόσουπα							
Ισχυρός κ.	12-17		8	7-9		1	5-8
Κανονικός κ.	17-22		8	11-13		1	6-9
K. Wok	10-15		9	6-8		4	4-7
Κρέμα κολοκυθιού, σούπα μπορς							
Ισχυρός κ.	30-35		9	10-12		5	20-23
Κανονικός κ.	45-50		9	15-17		6	30-33
K. Wok	25-30		9	8-10		2	17-20

Φαγητό Καυστήρας	Συνολικός χρόνος σε λεπτά	Βήμα 1			Βήμα 2		
							
Μινεστρόνε (σούπα λαχανικών)							
Ισχυρός κ.	47-52		9	10-12		5	37-40
Κανονικός κ.	57-62		9	10-12		6	47-50
K. Wok	43-48		8	8-10		3	35-38
Ζυμαρικά και ρύζι							
Σπαγκέτι							
Ισχυρός κ.	18-22		9	8-10		6	10-12
Κανονικός κ.	20-24		9	10-12		7	10-12
K. Wok	18-22		8	8-10		6	10-12
Ρύζι:							
Ισχυρός κ.	17-22		9	5-7		2	12-15
Κανονικός κ.	18-23		9	7-9		6	11-14
K. Wok	15-20		8	4-6		2	11-14
Ραβιόλια							
Ισχυρός κ.	9-14		9	4-6		6	5-8
Κανονικός κ.	17-22		8	12-14		8	5-8
K. Wok	10-15		8	5-7		8	5-8
Λαχανικά και όσπρια							
Βραστάς πατάτες (πουρέ, παταποσαλάτα)							
Ισχυρός κ.	23-28		9	8-10		5	15-18
Κανονικός κ.	25-30		9	10-12		6	15-18
K. Wok	25-30		7	11-13		5	14-17
Χούμους (ρεβίθια πουρέ)							
Ισχυρός κ.	50-55		9	10-12		4	40-43
Κανονικός κ.	52-57		9	12-14		5	40-43
K. Wok	47-52		7	10-12		5	37-40
Φακές							
Ισχυρός κ.	40-45		9	8-10		8	32-35
Κανονικός κ.	50-55		9	18-20		6	32-35
K. Wok	45-50		6	20-22		4	25-28
Τηγανητά στη φριτζά λαχανικά							
Ισχυρός κ.	12-17		7	6-8		6	6-9
Κανονικός κ.	15-20		8	8-10		7	7-10
K. Wok	11-16		7	6-8		5	5-8
Σοταρισμένα φρέσκα λαχανικά**							
K. Wok	6-8		9	6-8			
Ισχυρός κ.	6-8		9	6-8			
Τηγανητές πατάτες							
K. Wok	15-20		7	15-20			
Ισχυρός κ.	15-20		9	15-20			
Κανονικός κ.	25-30		9	25-30			
Αυγά							
Shakshuka							
Κανονικός κ.	15-20		9	10-12		4	5-8

Φαγητό Καυστήρας	Συνολι- κός χρό- νος σε λεπτά	Βήμα 1			Βήμα 2		
Ισχυρός κ.	13-18		8	7-9		3	6-9
Κ. Wok	15-20		6	11-13		4	4-7
Ομελέτα (1 μερίδα)							
Κανονικός κ.	3-5		8	3-5			
Ισχυρός κ.	2-4		9	2-4			
Κ. Wok	2-4		5	2-4			
Ισπανική τортίγια							
Ισχυρός κ.	25-30		9	25-30			
Κ. Wok	18-23		9	18-23			
Σάλτσες							
Σάλτσα μπεσαμέλ**							
Οικονομικός κ.	10-15		6	2-4		6	8-11
Κανονικός κ.	10-15		5	2-4		5	8-11
Κ. Wok	3-8		5	1-2		5	2-6
Σάλτσα με μπλε τυρί**							
Οικονομικός κ.	4-6		7	4-6			
Κανονικός κ.	3-5		7	3-5			
Ισχυρός κ.	3-5		5	3-5			
Σάλτσα ναπολιτάνα							
Κανονικός κ.	18-23		6	2-4		4	16-19
Κ. Wok	13-18		7	1-3		5	12-15
Ισχυρός κ.	15-20		8	1-3		6	14-17
Σάλτσα καρμπονάρα							
Κανονικός κ.	10-15		6	5-7		3	5-8
Ισχυρός κ.	8-13		5	4-6		3	4-7
Οικονομικός κ.	10-15		9	5-7		5	5-8
Ψάρι							
Μπακαλιάρος αλά ρωμαϊκά							
Ισχυρός κ.	5-10		8	5-10			
Κανονικός κ.	8-13		9	8-13			
Κ. Wok	4-9		6	4-9			
Τηγανητός σολομός							
Ισχυρός κ.	5-10		7	2-4		1	3-6
Κανονικός κ.	5-10		8	2-4		1	3-6
Κ. Wok	7-12		8	2-4		1	5-8
Μύδια							
Ισχυρός κ.	5-7		9	5-7			
Κ. Wok	4-6		9	4-6			
Κανονικός κ.	10-12		9	10-12			
Κρέας							
Στήθος πάπιας (1 κομμάτι)							
Κανονικός κ.	6-8		7	6-8			
Ισχυρός κ.	9-11		7	9-11			
Κ. Wok	6-8		5	6-8			

Φαγητό Καυστήρας	Συνολι- κός χρό- νος σε λεπτά	Βήμα 1			Βήμα 2		
Βοδινό φιλέτο στρογκανόφ							
Ισχυρός κ.	8-13		9	8-13			
Κ. Wok	5-10		8	5-10			
Κανονικός κ.	12-17		9	12-17			
Σνίτσελ κοτόπουλου (8 φιλέτα από στήθος κοτόπουλου)							
Ισχυρός κ.	7-12		9	2-4		6	5-8
Κ. Wok	7-12		9	2-4		6	5-8
Κανονικός κ.	7-12		9	7-12			
Κιμάς (πατέ κρέατος, κεφτεδάκια, σάλτσα μπολονέζε)							
Ισχυρός κ.	15-20		8	15-20			
Κανονικός κ.	20-25		9	20-25			
Κ. Wok	15-20		6	15-20			
Έτοιμα προϊόντα							
Καταψυγμένες κροκέτες (16 κομμάτια)							
Καταψυγμένα φετάκια ψαριού πανέ (12 κομμάτια)							
Ισχυρός κ.	6-10		8	6-10			
Κ. Wok	5-9		8	5-9			
Κανονικός κ.	8-12		8	8-12			
Ψητά λουκάνικα (12 κομμάτια)							
Ισχυρός κ.	5-10		9	1-3		7	4-7
Κανονικός κ.	7-12		9	7-12			
Κ. Wok	5-10		9	1-3		7	4-7
Βραστά λουκάνικα (12 κομμάτια)							
Κανονικός κ.	8-13		9	8-13			
Κ. Wok	9-14		4	9-14			
Ισχυρός κ.	7-12		7	7-12			
Χάμπουργκερ (4 κομμάτια)							
Ισχυρός κ.	4-9		9	1-3		7	3-6
Κ. Wok	4-9		9	1-3		7	3-6
Κανονικός κ.	5-10		9	1-3		8	4-7
Κατεψυγμένα λαχανικά**							
Ισχυρός κ.	7-12		9	7-12			
Κ. Wok	5-10		9	5-10			
Κανονικός κ.	12-17		9	12-17			
Πίτσα (20 cm διάμετρος)							
Κ. Wok	4-8		1	4-8			
Ισχυρός κ.	16-20		1	16-20			
Κανονικός κ.	20-25		1	20-25			
Επιδόρπια							
Πουτίγκα ρυζιού**							
Κανονικός κ.	30-35		8	9-11		4	21-24
Οικονομικός κ.	40-45		9	12-14		2	28-31
Κ. Wok	35-40		7	11-13		1	24-27

Φαγητό Καυστήρας	Συνολι- κός χρό- νος σε λεπτά	Βήμα 1		Βήμα 2	
Σοκολάτα γάλακτος					
Οικονομικός κ.	10-14		1	10-14	
Κανονικός κ.	16-20		1	16-20	
Κρέπες (4 κομμάτια)					
Ισχυρός κ.	17-22		7	1-3	5 16-19
K. Wok	8-13		7	1-3	4 7-10
Κανονικός κ.	20-25		8	1-3	6 19-22
Πουτίγκα ψωμιού					
Ισχυρός κ.	25-30		9	10-12	6 15-18
K. Wok	23-28		9	8-10	7 15-18
Κανονικός κ.	27-32		9	10-12	7 17-20
Ισπανική πουτίγκα**					
Ισχυρός κ.	3-8		5	3-8	
Κανονικός κ.	8-13		5	8-13	
K. Wok	3-8		2	3-8	
Κέικ (σε μπεν μαρί)					
Ισχυρός κ.	35-40		9	35-40	
K. Wok	40-45		9	40-45	
Κανονικός κ.	45-50		9	45-50	

Συμβουλές μαγειρέματος

- Χρησιμοποιείτε για την παρασκευή σουπών κρέμας και οσπρίων μια χύτρα ταχύτητας. Ο χρόνος μαγειρέματος μειώνεται σημαντικά. Εάν χρησιμοποιήσετε μια χύτρα ταχύτητας, ακολουθήστε τις οδηγίες του κατασκευαστή. Προσθέστε όλα τα υλικά αμέσως στην αρχή.
- Τοποθετείτε κατά το μαγείρεμα πατατών και ρυζιού πάντοτε ένα καπάκι. Έτσι ο χρόνος μαγειρέματος γίνεται σημαντικά μικρότερος. Το νερό πρέπει να βράζει, προτού προσθέσετε τα ζυμαρικά, το ρύζι ή τις πατάτες. Προσαρμόστε στη συνέχεια τη βαθμίδα μαγειρέματος, για να συνεχίσετε με το μαγείρεμα.
- Στα τηγανητά φαγητά ζεστάνετε πρώτα το λάδι. Μόλις αρχίσετε με το τηγάνισμα, κρατήστε τη θερμοκρασία σταθερή, προσαρμόζοντας σε περίπτωση που χρειάζεται τη βαθμίδα μαγειρέματος. Στην παρασκευή περισσότερων μερίδων περιμένετε, μέχρι να επιτευχθεί ξανά η θερμοκρασία μαγειρέματος. Γυρίζετε τακτικά τα φαγητά.
- Όταν μαγειρεύετε σούπες, κρέμες, φακές ή ρεβίθια, προσθέστε όλα τα υλικά ταυτόχρονα στο μαγειρικό σκεύος.

Καθαρισμός και συντήρηση

Καθαρισμός

Μόλις κρυώσει η συσκευή, καθαρίστε την με ένα σφουγγάρι, νερό και σαπούνι.

Μετά από κάθε χρήση, μόλις κρυώσει ο καυστήρας καθαρίστε την επιφάνεια των αντίστοιχων εξαρτημάτων του. Εάν αφήσετε υπολείμματα (επαναψημένα τρόφιμα, στάγματα λίπους, κτλ.), ακόμη και αν είναι λίγα, θα σχηματίσουν μια κρούστα στην επιφάνεια και θα είναι πολύ δύσκολο να τα καθαρίσετε. Είναι απαραίτητο να είναι καθαρές οι οπές και οι εγκοπές, για μια καλή φλόγα.

Η μετακίνηση κάποιων σκευών μπορεί να αφήσει μεταλλικά υπολείμματα πάνω στις σχάρες.

Καθαρίστε με σαπουνόνερο και τρίψτε με μια μη μεταλλική βούρτσα τους καυστήρες και τις σχάρες.

Εάν οι σχάρες διαθέτουν ελαστικούς τάκους, προσέξτε κατά τον καθαρισμό τους. Οι τάκοι μπορεί να βγουν και η σχάρα μπορεί να χαράξει τη βάση εστιών.

Να στεγνώνετε πάντα καλά τους καυστήρες και τις σχάρες. Εάν υπάρχουν σταγόνες νερού ή υγρές περιοχές κατά την έναρξη του μαγειρέματος, μπορεί να φθείρει το σμάλτο.

Μετά από τον καθαρισμό και το στέγνωμα των καυστήρων, βεβαιωθείτε ότι τα καλύμματα είναι καλά τοποθετημένα πάνω στο διαχυτήρα.

Προσοχή!

- Για τον καθαρισμό της συσκευής μην αφαιρέσετε τα στοιχεία χειρισμού. Εισερχόμενη υγρασία μπορεί να προκαλέσει ζημιά στη συσκευή.
- Μην χρησιμοποιείτε συσκευές για καθαριότητα με ατμό. Μπορεί να φθείρει τη βάση εστιών.
- Μην χρησιμοποιείτε κανένα προϊόν καθαρισμού, σφουγγαράκια από σύρμα, αιχμηρά αντικείμενα, μαχαιρία κ.λπ. για να απομακρύνεται τα σκληρωμένα υπολείμματα φαγητού από τη βάση εστιών.
- Μην χρησιμοποιείτε μαχαιρία, ξύστρες ή παρόμοια για να καθαρίσετε το σύνολο κρυστάλλου με τα πλαίσια των καυστήρων, μεταλλικά πλαίσια ή του πίνακες από κρύσταλλο εάν υπάρχουν.

Συντήρηση

Καθαρίστε άμεσα τα υγρά που υπερχειλίζουν. Έτσι θα εμποδίσετε τα υπολείμματα φαγητού να κολλήσουν και θα εξοικονομήσετε περιττές προσπάθειες.

Μην σύρετε πάνω στο γυαλί τα σκεύη γιατί μπορεί να το γρατζουνίσουν. Ομοίως, αποφύγετε την πτώση σκληρών ή αιχμηρών αντικειμένων πάνω στον κρύσταλλο. Μη χτυπάτε κανένα από τα άκρα της βάσης εστιών.

Οι κόκκοι άμμου (που προέρχονται, για παράδειγμα, από τον καθαρισμό λαχανικών και κηπευτικών) χαράζουν την επιφάνεια του κρυστάλλου.

Αν έχει χυθεί λιωμένη ζάχαρη και τρόφιμα με υψηλή περιεκτικότητα σε ζάχαρη, θα πρέπει να καθαρίσετε αμέσως την εστία με τη βοήθεια της ξύστρας για κρύσταλλο.

Βλάβες, τι μπορεί να γίνει;

Σε ορισμένες περιπτώσεις οι τυχόν εμφανιζόμενες βλάβες μπορούν να αντιμετωπιστούν εύκολα. Πριν καλέσετε την υπηρεσία τεχνικής εξυπηρέτησης πελατών, προσέξτε τις ακόλουθες υποδείξεις:

Πρόβλημα	Πιθανή αιτία	Λύση
Βλάβη του ηλεκτρικού ρεύματος στο γενικό πίνακα.	Ελαττωματική ασφάλεια.	Ελέγξτε στο γενικό πίνακα με τις ασφάλειες εάν η ασφάλεια είναι καμένη και αλλάξτε την.
	Το αυτόματο ή ένα διαφορικό έχει πηδήξει.	Ελέγξτε το γενικό πίνακα διανομής μήπως έχει πηδήξει το αυτόματο ή το διαφορικό.
Δεν λειτουργεί το αυτόματο άναμμα.	Μπορεί να υπάρχουν υπολείμματα τροφών ή καθαρισμού ανάμεσα στον σπινθηριστές και στους καυστήρες.	Το κενό ανάμεσα στον σπινθηριστή και στον καυστήρα πρέπει να είναι καθαρό.
	Οι καυστήρες είναι υγροί.	Στεγνώστε με προσοχή τα καπάκια του καυστήρα.
	Τα καπάκια των καυστήρων δεν είναι καλά τοποθετημένα.	Ελέγξτε αν τα καπάκια είναι καλά τοποθετημένα.
	Η συσκευή δεν έχει γείωση, δεν είναι σωστή η σύνδεση ή η γείωση έχει πρόβλημα.	Επικοινωνήστε με τον ηλεκτρολόγο εγκατάστασης.
Η φλόγα του καυστήρα δεν είναι ομοιόμορφη.	Τα καπάκια των καυστήρων δεν είναι καλά τοποθετημένα.	Τοποθετήστε σωστά τα κομμάτια πάνω στον ανάλογο καυστήρα.
	Οι εγκοπές του καυστήρα είναι βρώμικες.	Καθαρίστε τις εγκοπές του καυστήρα.
Η ροή αερίου δεν φαίνεται κανονική, ή δεν βγαίνει αέριο.	Η ροή αερίου είναι κλειστή από τα ενδιάμεσα κλειδιά.	Ανοίξτε τα πιθανά ενδιάμεσα κλειδιά.
	Εάν το αέριο προέρχεται από φιάλη, ελέγξτε αν είναι άδεια.	Αλλάξτε τη φιάλη.
Η κουζίνα μυρίζει αέριο.	Κάποιοι κρουνοί είναι ανοιχτός.	Κλείστε τους κρουνοί.
	Μη σωστή εφαρμογή της φιάλης.	Ελέγξτε αν η σύνδεση είναι σωστή.
	Πιθανή διαρροή αερίου.	Κλείστε το γενικό κλειδί αερίου, αερίστε το χώρο και ειδοποιήστε αμέσως έναν εξουσιοδοτημένο τεχνικό εγκατάστασης για να ελέγξει και να πιστοποιήσει την εγκατάσταση. Μην χρησιμοποιείτε τη συσκευή μέχρι να βεβαιωθείτε ότι δεν υπάρχει καμία διαρροή αερίου στην εγκατάσταση ή στη συσκευή.
Ο καυστήρας σβήνει αμέσως μόλις αφήσετε το διακόπτη.	Δεν πατήσατε για αρκετό χρονικό διάστημα το διακόπτη.	Μόλις ανάψετε τον καυστήρα, κρατήστε πατημένο το διακόπτη για μερικά ακόμα δευτερόλεπτα.
	Οι εγκοπές του καυστήρα είναι βρώμικες.	Καθαρίστε τις εγκοπές του καυστήρα.



Υπηρεσία εξυπηρέτησης πελατών

Εάν επικοινωνήσετε με το Τεχνικό μας Σέρβις, θα πρέπει να γνωρίζετε τον αριθμό του προϊόντος (E-Nr.) και τον αριθμό παραγωγής (FD) της συσκευής. Αυτή η πληροφορία υπάρχει στην ετικέτα χαρακτηριστικών, που βρίσκεται στο κάτω μέρος της βάσης εστιών, και στην ετικέτα του εγχειριδίου.

Τα στοιχεία επικοινωνίας όλων των χωρών θα τα βρείτε στον πίνακα Υπηρεσίες τεχνικής εξυπηρέτησης πελατών που παραδίδεται μαζί.

Εντολή επισκευής και συμβουλές σε περίπτωση βλάβης

GR 18 182

χρέωση κλήσης προς εθνικά δίκτυα

Εμπιστευθείτε την εμπειρία του κατασκευαστή. Έτσι εξασφαλίζετε, ότι η επισκευή γίνεται από εκπαιδευμένους τεχνικούς του σέρβις, που είναι εξοπλισμένοι με τα γνήσια ανταλλακτικά για τη συσκευή σας.

Όροι εγγύησης

Αν, αντίθετα από τις προσδοκίες μας, η συσκευή παρουσιάσει κάποια βλάβη ή δεν πληροί τις αναμενόμενες απαιτήσεις ποιότητας, σας παρακαλούμε να μας ενημερώσετε το συντομότερο δυνατόν. Για να είναι έγκυρη η εγγύηση σας, η συσκευή δεν πρέπει να έχει υποστεί παρέμβαση ή να έχει υποβληθεί σε κακή χρήση.

Οι όροι εγγύησης που εφαρμόζονται είναι αυτοί που ορίζονται από την εκπροσώπηση της εταιρίας μας στη χώρα όπου έγινε η αγορά. Μπορείτε να ζητήσετε περισσότερες πληροφορίες στο κατάστημα αγοράς. Είναι αναγκαίο να παρουσιάσετε την απόδειξη αγοράς για να χρησιμοποιήσετε την εγγύηση.

Διατήρηση του δικαιώματος για τροποποιήσεις.



Προστασία περιβάλλοντος

Εάν πάνω στην πινακίδα τύπου της συσκευής βρίσκεται το σύμβολο , προσέξτε τις ακόλουθες υποδείξεις.

Απόσυρση σύμφωνα με τους κανόνες προστασίας του περιβάλλοντος

Αποσύρετε την συσκευασία σύμφωνα με τους κανόνες προστασίας του περιβάλλοντος.









Αυτή η συσκευή είναι χαρακτηρισμένη σύμφωνα με την ευρωπαϊκή οδηγία 2012/19/ΕΕ περί ηλεκτρικών και ηλεκτρονικών παλιών συσκευών (waste electrical and electronic equipment - WEEE).

Η οδηγία αυτή καθορίζει τα πλαίσια για την απόσυρση και αξιοποίηση των παλιών συσκευών με ισχύ σε όλη την ΕΕ.

Το περιτύλιγμα της συσκευής σας κατασκευάστηκε από τα απαιτούμενα υλικά για την εξασφάλιση της αποτελεσματικής προστασίας κατά τη μεταφορά. Αυτά τα υλικά είναι εξ ολοκλήρου ανακυκλώσιμα, μειώνοντας έτσι την επίπτωση στο περιβάλλον. Σας καλούμε να συνεισφέρετε και εσείς στη διατήρηση του περιβάλλοντος, ακολουθώντας τις παρακάτω συμβουλές:

- πετάξτε τη συσκευασία στον κατάλληλο κάδο ανακύκλωσης,
- απενεργοποιήστε τη συσκευή, πριν την απόρριψη της. Συμβουλευτείτε την τοπική σας αυτοδιοίκηση για την πιο κοντινή τοποθεσία του κέντρου διαλογής ανακυκλώσιμων υλικών και παραδώστε εκεί τη συσκευή σας,
- μην πετάτε το χρησιμοποιημένο λάδι στον νεροχύτη. Φυλάξτε το σε ένα κλειστό δοχείο και παραδώστε το σε κάποιο σημείο διαλογής ή, εάν δεν υπάρχει, σε έναν κάδο σκουπιδιών (πολύ πιθανόν να καταλήξει σε κάποιο ελεγχόμενο σκουπιδότοπο, ίσως δεν είναι η καλύτερη λύση, αλλά τουλάχιστον αποφεύγουμε τη μόλυνση του νερού).

Índice

	Uso correcto del aparato	13
	Indicaciones de seguridad importantes	14
	Presentación del aparato	15
	Mandos y quemadores	15
	Quemadores de gas	16
	Encendido manual	16
	Encendido automático	16
	Sistema de seguridad	16
	Apagar un quemador	16
	Advertencias	16
	Tablas y consejos	16
	Recipientes apropiados	16
	Advertencias de uso	16
	Tabla de cocción	17
	Limpieza y cuidados del aparato	20
	Limpieza	20
	Mantenimiento	20
	¿Qué hacer en caso de avería?	20
	Servicio de Asistencia Técnica	21
	Condiciones de garantía	21
	Protección del medio ambiente	21
	Eliminación de residuos respetuosa con el medio ambiente	21

Uso correcto del aparato

Lea atentamente estas instrucciones. Solo entonces podrá manejar su aparato de manera efectiva y segura. Conserve las instrucciones de uso e instalación y entréguelas con el aparato si este cambia de dueño.

El fabricante queda exento de toda responsabilidad si no se cumplen las disposiciones de este manual.

Las imágenes representadas en estas instrucciones tienen carácter orientativo.

No saque el aparato del embalaje protector hasta el momento del encastre. Si observa algún daño en el aparato, no lo conecte. Póngase en contacto con nuestro Servicio Técnico.

Este aparato corresponde a la clase 3, según la norma EN 30-1-1 para aparatos a gas: aparato encastrado en un mueble.

Antes de instalar su nueva placa de cocción asegúrese de que la instalación se realiza siguiendo las instrucciones de montaje.

Este aparato no puede ser instalado en yates o caravanas.

Este aparato se debe utilizar únicamente en lugares suficientemente ventilados.

Este aparato no está previsto para el funcionamiento con un reloj temporizador externo o un mando a distancia.

Todos los trabajos de instalación, conexión, regulación y adaptación a otros tipos de gas deben ser realizados por un técnico autorizado, respetando toda la normativa y legislación aplicables y las prescripciones de las compañías locales proveedoras de gas y electricidad. Se pondrá especial atención a las disposiciones aplicables en cuanto a la ventilación.

Este aparato sale de fábrica adaptado al tipo de gas que indica la placa de características. Si fuera necesario cambiarlo, consulte las instrucciones de montaje. Se recomienda llamar a nuestro Servicio Técnico para la adaptación a otros tipos de gas.

Este aparato ha sido diseñado solo para uso doméstico, no está permitido su uso comercial o profesional. Utilice el aparato únicamente para cocinar, nunca como

calefacción. La garantía únicamente tendrá validez en caso de que se respete el uso para el que fue diseñado.

Este aparato está previsto para ser utilizado a una altura máxima de 2.000 metros sobre el nivel del mar.

Durante el funcionamiento, el aparato no debe dejarse sin vigilancia.

No use tapas o barreras de protección para niños que no estén recomendadas por el fabricante de la placa de cocción. Pueden provocar accidentes, p. ej. debido al sobrecalentamiento, ignición o desprendimiento de fragmentos de materiales.

Este aparato puede ser utilizado por niños a partir de 8 años y por personas con limitaciones físicas, sensoriales o psíquicas, o que carezcan de experiencia y conocimientos, siempre y cuando sea bajo la supervisión de una persona responsable de su seguridad o que le haya instruido en el uso correcto del aparato siendo consciente de los daños que se pudieran ocasionar.

No dejar que los niños jueguen con el aparato. La limpieza y el mantenimiento rutinario no deben encomendarse a los niños a menos que sean mayores de 15 años y lo hagan bajo supervisión.

Mantener a los niños menores de 8 años alejados del aparato y del cable de conexión.

Indicaciones de seguridad importantes

Advertencia – ¡Peligro de deflagración!

La acumulación de gas sin quemar en un recinto cerrado conlleva peligro de deflagración. No someta el aparato a corrientes de aire. Los quemadores podrían apagarse. Lea atentamente las instrucciones y advertencias relativas al funcionamiento de los quemadores de gas.

Advertencia – ¡Peligro de intoxicación!

El uso de un aparato de cocción a gas produce calor, humedad y productos de combustión en el local donde está instalado. Asegure una buena ventilación de la cocina, especialmente mientras la placa de cocción esté en funcionamiento: mantenga abiertos los orificios de ventilación natural o instale un dispositivo de ventilación mecánica (campana extractora). La utilización intensa y prolongada del aparato puede necesitar una ventilación complementaria o más eficaz: abra una ventana o aumente la potencia de la ventilación mecánica.

Advertencia – ¡Peligro de quemaduras!

- Las zonas de cocción y adyacentes se calientan mucho. No toque nunca las superficies calientes. Mantenga alejados a los niños menores de 8 años.
- Si la botella de gas líquido no está en posición vertical, el propano/butano líquido puede llegar al interior del aparato, por lo que puede causar llamas vivas en los quemadores. Con el tiempo, los componentes pueden dañarse y perder estanqueidad, de modo que puede escaparse gas. Ambos casos pueden producir quemaduras. Utilizar botellas de gas líquido siempre en posición vertical.

Advertencia – ¡Peligro de incendio!

- Las zonas de cocción se calientan mucho. No coloque objetos inflamables sobre la placa de cocción. No almacene objetos sobre la placa de cocción.
- No almacene ni utilice productos químicos corrosivos, vapores, materiales inflamables ni productos no alimenticios debajo de este electrodoméstico ni cerca de él.

- Las grasas o aceites sobrecalentados se inflaman fácilmente. No se ausente mientras caliente grasa o aceite. Si se inflaman, no apague el fuego con agua. Cubra el recipiente con una tapa para sofocar el fuego y desconecte la zona de cocción.

⚠ Advertencia – ¡Peligro de lesiones!

- Las fisuras o roturas en la placa de cristal conllevan peligro. Apague inmediatamente todos los quemadores y cualquier elemento eléctrico de calentamiento. Desenchufe el aparato de la red o desconecte el fusible en la caja de fusibles. Corte la alimentación de gas. No toque la superficie del aparato. Nunca conecte un aparato defectuoso. Avise al servicio de asistencia técnica.
- Los cambios bruscos de temperatura pueden provocar la rotura del cristal. Evite las corrientes de aire y derramar líquidos fríos durante la utilización de la placa de cocción.
- Los recipientes que presenten daños, tengan un tamaño inadecuado, rebasen los bordes de la placa de cocción o estén mal situados pueden provocar lesiones graves. Observe los consejos y advertencias relativos a los recipientes de cocinado.
- Las reparaciones inadecuadas son peligrosas. Las reparaciones y la sustitución de cables eléctricos y conductos de gas defectuosos solo pueden ser efectuadas por personal del Servicio Técnico debidamente instruido. Si el aparato está averiado, desenchufarlo de la red o desconectar el interruptor automático del cuadro eléctrico y cortar la alimentación de gas. Avisar al Servicio de Asistencia Técnica.
- Si alguno de los mandos no se puede girar o está suelto, no lo use. Llame inmediatamente al servicio técnico para que proceda a su reparación o sustitución.

⚠ Advertencia – ¡Peligro de descarga eléctrica!

- No utilice máquinas de limpieza a vapor para limpiar el aparato.
- Las fisuras o roturas en la placa de cristal conllevan riesgo de electrocución. Desconectar el fusible de la caja de fusibles. Avisar al Servicio de Asistencia Técnica.

Presentación del aparato

En el resumen de los modelos encontrará una vista general de su aparato así como la potencia de los quemadores. → *Página 2*

Mandos y quemadores

Cada mando de accionamiento tiene señalado el quemador que controla. Los mandos le permiten regular la potencia que necesite, según las distintas posiciones, entre los niveles máximo y mínimo. Nunca intente pasar directamente de la posición 0 a la 1 ni volver de la posición 1 a la 0.

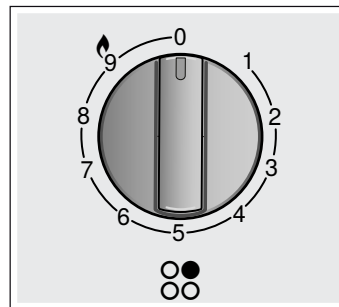

Indicaciones

	Quemador controlado por el mando
0	Quemador apagado
9	Potencia máxima y encendido eléctrico
1	Potencia mínima

Para un correcto funcionamiento del aparato es imprescindible asegurarse de que las parrillas y todas las piezas de los quemadores estén bien colocadas. No intercambie las tapas de los quemadores.

Retire las parrillas siempre con cuidado. El movimiento de una parrilla puede desplazar las parrillas contiguas.

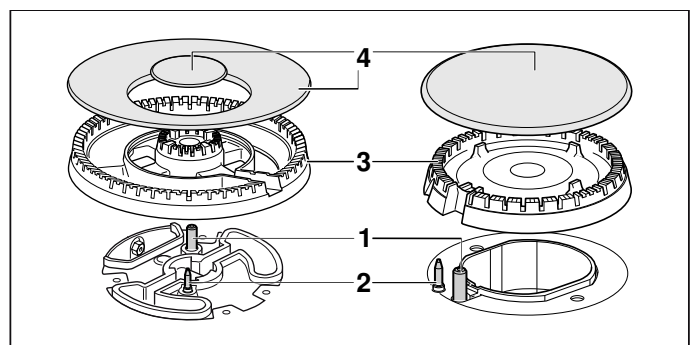

Elementos

1	Bujía
2	Termopar
3	Difusor
4	Tapa

Quemadores de gas

Encendido manual

1. Presione el mando del quemador elegido y gírelo hacia la izquierda hasta la posición de máxima potencia.
2. Acerque algún tipo de encendedor o llama (mecheros, cerillas, etc.) al quemador.

Encendido automático

Si su placa de cocción dispone de encendido automático (bujías):

1. Presione el mando del quemador elegido y gírelo hacia la izquierda hasta la posición de máxima potencia. Mientras el mando está presionado se producen chispas en todos los quemadores. La llama se enciende.
2. Deje de presionar el mando.
3. Gire el mando a la posición deseada.

Si no se produce el encendido, gire el mando a la posición de apagado y repita los pasos. Esta vez mantenga el mando presionado durante más tiempo (hasta 10 segundos).

Advertencia – ¡Peligro de deflagración!

Si transcurridos 15 segundos la llama no se enciende, apague el quemador y abra la puerta o ventana del recinto. Espere al menos un minuto antes de intentar encender el quemador.

Nota: Mantenga la máxima limpieza. Si las bujías están sucias el encendido será defectuoso. Límpielas periódicamente con un cepillo no metálico pequeño. Tenga en cuenta que las bujías no deben sufrir impactos violentos.

Sistema de seguridad

Su placa de cocción dispone de un sistema de seguridad (termopar) que impide el paso de gas si los quemadores se apagan accidentalmente.

Para garantizar que este dispositivo esté activo:

1. Encienda el quemador con normalidad.
2. Sin soltar el mando, manténgalo presionado firmemente durante 4 segundos tras haberse encendido la llama.

Apagar un quemador

Gire el mando correspondiente hacia la derecha hasta la posición 0.

Unos segundos después del apagado del quemador se producirá un sonido (golpe seco). No es ninguna anomalía, eso significa que la seguridad se ha desactivado.

Advertencias

Durante el funcionamiento del quemador es normal que se escuche un leve silbido.

En los primeros usos es normal que se desprendan olores. Esto no supone ningún riesgo ni mal funcionamiento. Irán desapareciendo.

Una llama de color naranja es normal. Se debe a la presencia de polvo en el ambiente, líquidos derramados, etc.

En el caso de una extinción accidental de las llamas del quemador, cierre el mando de accionamiento del quemador y no intente reencenderlo durante por lo menos 1 minuto.

Tablas y consejos

Recipientes apropiados

Quemador	Diámetro mínimo de la base del recipiente	Diámetro máximo de la base del recipiente
Quemador wok	22 cm	30 cm
Quemador rápido	20 cm	26 cm
Quemador semi-rápido	14 cm	22 cm
Quemador auxiliar	12 cm	16 cm

El recipiente no debe rebasar los bordes de la placa de cocción.

Advertencias de uso

Los siguientes consejos le ayudarán a ahorrar energía y a evitar daños en los recipientes:

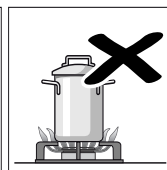
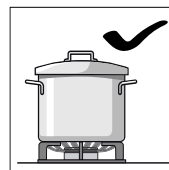

Utilice recipientes de tamaño apropiado a cada quemador.

No utilice recipientes pequeños en quemadores grandes. La llama no debe tocar los laterales del recipiente.

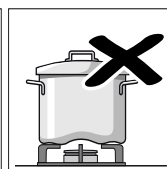
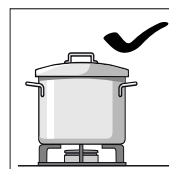

No utilice recipientes deformados que se muestren inestables sobre la placa de cocción. Los recipientes podrían volcar. Utilice solo recipientes de base plana y gruesa.

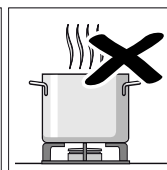
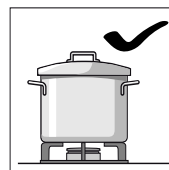

No cocine sin tapa o con esta desplazada. Se desperdicia parte de la energía.

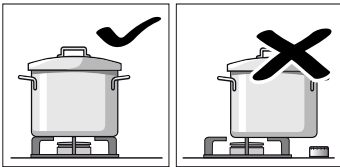

Coloque el recipiente bien centrado sobre el quemador. En caso contrario podría volcar. No coloque los recipientes grandes en los quemadores cercanos a los mandos. Estos pueden resultar dañados debido al exceso de temperatura.

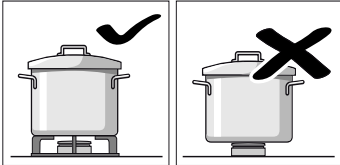

Coloque los recipientes sobre las parrillas, nunca directamente sobre el quemador. Asegúrese de que las parrillas y tapas de los quemadores estén bien colocadas antes de su uso.

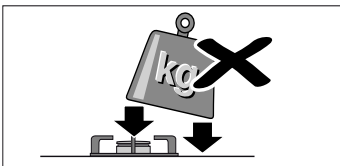

Maneje los recipientes con cuidado sobre la placa de cocción. No golpee la placa de cocción ni coloque sobre ella pesos excesivos.

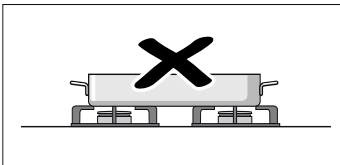

No utilice dos quemadores o fuentes de calor para un solo recipiente. Evite la utilización de planchas de asado, cazuelas de barro, etc. prolongadamente a máxima potencia.

Tabla de cocción

En la tabla siguiente se presentan las posiciones y tiempos de cocción óptimos para una selección de platos. Los datos son valores de referencia para cuatro comensales.

El tiempo y las posiciones de cocción dependen del tipo, peso y calidad de los alimentos, del tipo de gas, así como del material de los recipientes de cocinado. Para cocinar estos platos se han utilizado principalmente recipientes de cocinado de acero inoxidable.

Utilice siempre recipientes de cocinado de diámetros adecuados y colóquelos bien centrados sobre el quemador. Consulte la información relativa a los diámetros de recipientes de cocinado. → "Recipientes apropiados"

Cómo interpretar la tabla

La elaboración de cada plato consta de uno o dos pasos. Cada paso contiene información sobre:

- Método de cocción
- Posición de cocción
- Duración en minutos

Métodos de cocción indicados en la tabla

- Llevar a ebullición
- Mantener ebullición
- Ganar presión en olla a presión
- Mantener presión en olla a presión
- Freír fuerte
- Freír suave
- Derretir, fundir
- * Sin tapa
- ** Remover continuamente

Nota: Los símbolos no aparecen en el aparato, se utilizan como orientación sobre los cambios de modo de cocinado.

Se presentan indicaciones para cocinar cada plato en diferentes quemadores. La opción recomendada es el primer quemador mencionado. En el resumen de los modelos está identificado cada quemador de la placa de cocción. → *Página 2*

Ejemplo:

Plato	Quemador	Tiempo total en min	Paso 1			Paso 2		
Sopas, cremas								
Sopa de pescado								
Quemador rápido		12-17		8	7-9		1	5-8
Quemador semi-rápido		17-22		8	11-13		1	6-9
Quemador wok		10-15		9	6-8		4	4-7

En el ejemplo se muestran indicaciones para cocinar sopa de pescado utilizando los quemadores rápido, semi-rápido o wok.

Utilizando el quemador rápido (opción recomendada) el tiempo total para la cocción es de 12 a 17 minutos.

















- Paso 1: llevar a ebullición. Utilice la posición de cocción 8 durante 7-9 minutos.
- Paso 2: mantener ebullición. Cambie a la posición 1 durante 5-8 minutos.

















Las indicaciones para el resto de quemadores propuestos se deben interpretar de forma análoga.

Plato	Quemadores	Tiem-po total en min	Paso 1			Paso 2		
Sopas, cremas								
Sopa de pescado								
Quemador rápido		12-17		8	7-9		1	5-8
Q. semi-rápido		17-22		8	11-13		1	6-9
Quemador wok		10-15		9	6-8		4	4-7
Crema de calabaza, sopa Borsch								
Quemador rápido		30-35		9	10-12		5	20-23
Q. semi-rápido		45-50		9	15-17		6	30-33
Quemador wok		25-30		9	8-10		2	17-20

Plato	Tiempo total en min	Paso 1			Paso 2			
		Quemadores				Quemadores		
Minestrone (sopa de verduras)								
Quemador rápido	47-52		9	10-12		5	37-40	
Q. semi-rápido	57-62		9	10-12		6	47-50	
Quemador wok	43-48		8	8-10		3	35-38	
Pasta y arroz								
Espaguetis								
Quemador rápido	18-22	*	9	8-10		6	10-12	
Q. semi-rápido	20-24	*	9	10-12		7	10-12	
Quemador wok	18-22	*	8	8-10		6	10-12	
Arroz								
Quemador rápido	17-22		9	5-7		2	12-15	
Q. semi-rápido	18-23		9	7-9		6	11-14	
Quemador wok	15-20		8	4-6		2	11-14	
Ravioli								
Quemador rápido	9-14		9	4-6		6	5-8	
Q. semi-rápido	17-22		8	12-14		8	5-8	
Quemador wok	10-15		8	5-7		8	5-8	
Verduras y legumbres								
Patatas cocidas (puré, ensaladilla rusa)								
Quemador rápido	23-28		9	8-10		5	15-18	
Q. semi-rápido	25-30		9	10-12		6	15-18	
Quemador wok	25-30		7	11-13		5	14-17	
Hummus (puré de garbanzos)								
Quemador rápido	50-55		9	10-12		4	40-43	
Q. semi-rápido	52-57		9	12-14		5	40-43	
Quemador wok	47-52		7	10-12		5	37-40	
Lentejas								
Quemador rápido	40-45		9	8-10		8	32-35	
Q. semi-rápido	50-55		9	18-20		6	32-35	
Quemador wok	45-50		6	20-22		4	25-28	
Tempura de verduras								
Quemador rápido	12-17	*	7	6-8	*	6	6-9	
Q. semi-rápido	15-20	*	8	8-10	*	7	7-10	
Quemador wok	11-16	*	7	6-8	*	5	5-8	
Salteado de verduras frescas**								
Quemador wok	6-8	*	9	6-8				
Quemador rápido	6-8	*	9	6-8				
Patatas fritas								
Quemador wok	15-20	*	7	15-20				
Quemador rápido	15-20	*	9	15-20				
Q. semi-rápido	25-30	*	9	25-30				

Plato	Tiempo total en min	Paso 1			Paso 2			
		Quemadores				Quemadores		
Huevos								
Shakshuka								
Q. semi-rápido	15-20		9	10-12		4	5-8	
Quemador rápido	13-18		8	7-9		3	6-9	
Quemador wok	15-20		6	11-13		4	4-7	
Tortilla francesa (1 ud.)								
Q. semi-rápido	3-5	*	8	3-5				
Quemador rápido	2-4	*	9	2-4				
Quemador wok	2-4	*	5	2-4				
Tortilla de patata								
Quemador rápido	25-30	*	9	25-30				
Quemador wok	18-23	*	9	18-23				
Salsas								
Salsa bechamel**								
Q. auxiliar	10-15	*	6	2-4	*	6	8-11	
Q. semi-rápido	10-15	*	5	2-4	*	5	8-11	
Quemador wok	3-8	*	5	1-2	*	5	2-6	
Salsa de queso azul**								
Q. auxiliar	4-6	*	7	4-6				
Q. semi-rápido	3-5	*	7	3-5				
Quemador rápido	3-5	*	5	3-5				
Salsa napolitana								
Q. semi-rápido	18-23	*	6	2-4	*	4	16-19	
Quemador wok	13-18	*	7	1-3	*	5	12-15	
Quemador rápido	15-20	*	8	1-3	*	6	14-17	
Salsa carbonara								
Q. semi-rápido	10-15	*	6	5-7	*	3	5-8	
Quemador rápido	8-13	*	5	4-6	*	3	4-7	
Q. auxiliar	10-15	*	9	5-7	*	5	5-8	
Pescado								
Merluza a la romana								
Quemador rápido	5-10	*	8	5-10				
Q. semi-rápido	8-13	*	9	8-13				
Quemador wok	4-9	*	6	4-9				
Salmón asado								
Quemador rápido	5-10	*	7	2-4		1	3-6	
Q. semi-rápido	5-10	*	8	2-4		1	3-6	
Quemador wok	7-12	*	8	2-4		1	5-8	
Mejillones								
Quemador rápido	5-7		9	5-7				
Quemador wok	4-6		9	4-6				
Q. semi-rápido	10-12		9	10-12				

Plato	Tiem- po total en min	Paso 1	Paso 2
Quemadores		  	  
Carne			
Magret de pato (1 ud.)			
Q. semi-rápido	6-8	 * 7	6-8
Quegador rápido	9-11	 * 7	9-11
Quegador wok	6-8	 * 5	6-8
Solomillo Strogonoff			
Quegador rápido	8-13	 * 9	8-13
Quegador wok	5-10	 * 8	5-10
Q. semi-rápido	12-17	 * 9	12-17
Schnitzel de pollo (8 filetes de pechuga de pollo)			
Quegador rápido	7-12	 * 9	2-4  * 6 5-8
Quegador wok	7-12	 * 9	2-4  * 6 5-8
Q. semi-rápido	7-12	 * 9	7-12
Carne picada (pastel de carne, albóndigas, salsa boloñesa)			
Quegador rápido	15-20	 * 8	15-20
Q. semi-rápido	20-25	 * 9	20-25
Quegador wok	15-20	 * 6	15-20
Productos preparados			
Croquetas congeladas (16 uds.) Varitas de pescado congeladas (12 uds.)			
Quegador rápido	6-10	 8	6-10
Quegador wok	5-9	 8	5-9
Q. semi-rápido	8-12	 8	8-12
Salchichas fritas (12 uds.)			
Quegador rápido	5-10	 9	1-3  7 4-7
Q. semi-rápido	7-12	 9	7-12
Quegador wok	5-10	 9	1-3  7 4-7
Salchichas calentadas en agua (12 uds.)			
Q. semi-rápido	8-13	 9	8-13
Quegador wok	9-14	 4	9-14
Quegador rápido	7-12	 7	7-12
Hamburguesas (4 uds.)			
Quegador rápido	4-9	 * 9	1-3  * 7 3-6
Quegador wok	4-9	 * 9	1-3  * 7 3-6
Q. semi-rápido	5-10	 * 9	1-3  * 8 4-7
Verduras congeladas**			
Quegador rápido	7-12	 * 9	7-12
Quegador wok	5-10	 * 9	5-10
Q. semi-rápido	12-17	 * 9	12-17
Pizza (20 cm de diámetro)			
Quegador wok	4-8	 1	4-8
Quegador rápido	16-20	 1	16-20
Q. semi-rápido	20-25	 1	20-25

Plato	Tiem- po total en min	Paso 1	Paso 2
Quemadores		  	  
Postres			
Pudin de arroz**			
Q. semi-rápido	30-35	 * 8	9-11  * 4 21-24
Q. auxiliar	40-45	 * 9	12-14  * 2 28-31
Quegador wok	35-40	 * 7	11-13  * 1 24-27
Chocolate con leche			
Q. auxiliar	10-14	 * 1	10-14
Q. semi-rápido	16-20	 * 1	16-20
Crepes (4 uds.)			
Quegador rápido	17-22	 * 7	1-3  * 5 16-19
Quegador wok	8-13	 * 7	1-3  * 4 7-10
Q. semi-rápido	20-25	 * 8	1-3  * 6 19-22
Pudin de pan			
Quegador rápido	25-30	 9	10-12  6 15-18
Quegador wok	23-28	 9	8-10  7 15-18
Q. semi-rápido	27-32	 9	10-12  7 17-20
Natillas**			
Quegador rápido	3-8	 * 5	3-8
Q. semi-rápido	8-13	 * 5	8-13
Quegador wok	3-8	 * 2	3-8
Bizcocho (al baño maría)			
Quegador rápido	35-40	 9	35-40
Quegador wok	40-45	 9	40-45
Q. semi-rápido	45-50	 9	45-50

Consejos de cocinado

- Los tiempos de cocción de las cremas y legumbres pueden reducirse utilizando una olla a presión. Si utiliza una olla a presión siga las instrucciones del fabricante. Introduzca todos los ingredientes a la vez desde el principio.
- Utilizando tapa para la cocción de arroz y patata se reduce significativamente el tiempo de cocción. Lleve el agua a ebullición antes de introducir pasta, arroz o patatas y ajuste después la potencia para mantener la ebullición.
- Para las frituras se debe precalentar el aceite. Una vez iniciada la fritura del alimento, mantenga la temperatura constante ajustando la potencia si es necesario. Deje recuperar la temperatura del aceite entre diferentes lotes y dé vuelta a los alimentos frecuentemente.
- Introduzca todos los ingredientes a la vez en el recipiente para cocinar sopas, cremas, lentejas estofadas o garbanzos.



Limpieza y cuidados del aparato

Limpieza

Una vez frío el aparato, límpielo con una esponja, agua y jabón.

Después de cada uso, limpie la superficie de los respectivos elementos del quemador una vez que se haya enfriado. Si se dejan restos (alimentos recocidos, gotas de grasa, etc.), por poco que sea, se incrustarán en la superficie y serán luego más difíciles de eliminar. Es necesario que los agujeros y ranuras estén limpios para que la llama sea correcta.

El movimiento de algunos recipientes puede dejar restos metálicos sobre las parrillas.

Limpie los quemadores y las parrillas con agua jabonosa y frótelos con un cepillo no metálico.

Si las parrillas disponen de tacos de goma, tenga cuidado al limpiarlas. Los tacos pueden soltarse y la parrilla puede rayar la placa de cocción.

Seque completamente los quemadores y las parrillas siempre. La presencia de gotas de agua o zonas húmedas al comienzo de la cocción puede deteriorar el esmalte.

Después de la limpieza y secado de los quemadores, asegúrese de que las tapas estén bien colocadas sobre el difusor.

¡Atención!

- No extraiga los mandos para la limpieza del aparato. Si la humedad penetra en el aparato puede dañarlo.
- No utilice máquinas de limpieza a vapor. Podría dañar la placa de cocción.
- No utilice nunca productos abrasivos, estropajos de acero, objetos cortantes, cuchillos, etc. para quitar restos de comida endurecidos de la placa de cocción.
- No utilice cuchillos, rasquetas o similar para limpiar la unión del cristal con los embellecedores de los quemadores, perfiles metálicos ni en los paneles de cristal o aluminio si hubiere.

Mantenimiento

Limpie al instante los líquidos que se derramen. Así evitará que los restos de comida se peguen y se ahorrará esfuerzos innecesarios.

No deslice sobre el vidrio los recipientes, ya que puede rayarlo. Asimismo evite caídas de objetos duros o puntiagudos sobre el cristal. No golpee la placa de cocción por ninguno de sus cantos.

Los granos de arena (procedentes, por ejemplo, de la limpieza de verduras y hortalizas) rayan la superficie del cristal.

El azúcar fundido o los alimentos con elevado contenido de azúcar que se hubieran derramado deberán eliminarse inmediatamente de la zona de cocción con ayuda de la rasqueta para vidrio.



¿Qué hacer en caso de avería?

En ocasiones, las anomalías detectadas se pueden solucionar fácilmente. Antes de llamar al Servicio Técnico tenga en cuenta los siguientes consejos:

Anomalía	Posible causa	Solución
El funcionamiento eléctrico general está averiado.	Fusible defectuoso.	Comprobar en la caja general de fusibles si el fusible está averiado y cambiarlo.
	El automático o un diferencial ha saltado.	Comprobar en el cuadro general de mando si ha saltado el automático o un diferencial.
El encendido automático no funciona.	Pueden existir residuos de alimentos o de limpieza entre las bujías y los quemadores.	El espacio entre la bujía y el quemador debe estar limpio.
	Los quemadores están mojados.	Secar cuidadosamente las tapas del quemador.
	Las tapas del quemador están mal colocadas.	Comprobar que las tapas están bien colocadas.
	El aparato no está conectado a tierra, está mal conectado o la toma de tierra es defectuosa.	Póngase en contacto con el instalador eléctrico.
La llama del quemador no es uniforme.	Las piezas del quemador están mal colocadas.	Colocar correctamente las piezas sobre el quemador correspondiente.
	Las ranuras del quemador están sucias.	Limpia las ranuras del quemador.
El flujo de gas no parece normal o no sale gas.	El paso de gas está cerrado por llaves intermedias.	Abrir las posibles llaves intermedias.
	Si el gas proviene de una bombona, comprobar que no está vacía.	Cambiar la bombona.

Anomalia	Posible causa	Solución
Hay olor a gas en la cocina.	Algún grifo está abierto.	Cerrar los grifos.
	Mal acoplamiento de la bombona.	Comprobar que el acoplamiento es perfecto.
	Posible fuga de gas.	Cerrar la llave general de gas, ventilar el recinto y avisar inmediatamente a un técnico de instalación autorizado para la revisión y certificación de la instalación. No utilizar el aparato hasta asegurarse de que no existe ninguna fuga de gas en la instalación o el aparato.
El quemador se apaga inmediatamente después de soltar el mando.	No ha mantenido el mando presionado el tiempo suficiente.	Una vez encendido el quemador, mantener el mando presionado unos segundos más.
	Las ranuras del quemador están sucias.	Limpiar las ranuras del quemador.

Servicio de Asistencia Técnica

Si se solicita nuestro Servicio Técnico, se debe facilitar el número de producto (E-Nr.) y el número de fabricación (FD) del aparato. Esta información figura en la placa de características, situada en la parte inferior de la placa de cocción, y en la etiqueta del manual de uso.

Las señas de las delegaciones internacionales figuran en la lista adjunta de centros y delegaciones del Servicio de Asistencia Técnica Oficial.

Solicitud de reparación y asesoramiento en caso de averías

E 902 145 150

Confíe en la profesionalidad de su distribuidor. De este modo se garantiza que la reparación sea realizada por personal técnico especializado y debidamente instruido que, además, dispone de los repuestos originales del fabricante para su aparato doméstico.

Condiciones de garantía

Si, contrariamente a nuestras expectativas, el aparato presentara algún daño o no cumpliera con sus exigencias de calidad previstas, le rogamos nos lo haga saber lo antes posible. Para que la garantía tenga validez, el aparato no deberá haber sido manipulado, ni sometido a un mal uso.

Las condiciones de garantía aplicables son las establecidas por la representación de nuestra empresa en el país donde se haya efectuado la compra. Puede solicitarse información detallada en los puntos de venta. Es necesario presentar el justificante de compra para hacer uso de la garantía.

Reservado el derecho de modificaciones.

Protección del medio ambiente

Si en la placa de características del aparato aparece el símbolo , tenga en cuenta las siguientes indicaciones.

Eliminación de residuos respetuosa con el medio ambiente



Eliminar el embalaje de forma ecológica.









Este aparato está marcado con el símbolo de cumplimiento con la Directiva Europea 2012/19/UE relativa a los aparatos eléctricos y electrónicos usados (Residuos de aparatos eléctricos y electrónicos RAEE).

La directiva proporciona el marco general válido en todo el ámbito de la Unión Europea para la retirada y la reutilización de los residuos de los aparatos eléctricos y electrónicos.

El embalaje de su aparato se ha fabricado con los materiales estrictamente necesarios para garantizar una protección eficaz durante el transporte. Estos materiales son totalmente reciclables, reduciendo así el impacto medioambiental. Le invitamos a contribuir también en la conservación del medio ambiente, siguiendo los siguientes consejos:

- deposite el embalaje en el contenedor de reciclaje adecuado,
- antes de deshacerse de un aparato desechado, inutilícelo. Consulte en su administración local la dirección del centro recolector de materiales reciclables más próximo y entregue allí su aparato,
- no tire el aceite usado por el fregadero. Guárdelo en un recipiente cerrado y entréguelo en un punto de recogida o, en su defecto, en un contenedor de basura (acabará en un vertedero controlado; probablemente no es la mejor solución, pero evitamos la contaminación del agua).

Índice

	Utilização adequada	22
	Instruções de segurança importantes	23
	Conhecer o aparelho	24
	Elementos de comando e queimador	24
	Queimadores a gás	25
	Ligação manual	25
	Ignição automática	25
	Sistema de segurança	25
	Apagar um queimador	25
	Advertências	25
	Tabelas e sugestões	25
	Recipientes apropriados	25
	Advertências para utilização	25
	Tabela com tempos e potências de cozedura	26
	Limpeza e manutenção	29
	Limpeza	29
	Manutenção	29
	Defeito: O que fazer?	29
	Serviços Técnicos	30
	Condições de garantia	30
	Protecção do meio ambiente	30
	Eliminação ecológica	30

Utilização adequada

Leia atentamente estas instruções. Só assim poderá manusear o aparelho de forma eficaz e segura. Conserve as instruções de uso e de instalação e entregue-as juntamente com o aparelho se este mudar de dono.

O fabricante fica isento de qualquer tipo de responsabilidade caso não se cumpram as disposições deste manual.

As imagens apresentadas ao longo das instruções servem apenas para orientação.

Não retire o aparelho da embalagem de protecção até ao momento de ser encastrado. Se observar algum dano no aparelho, não o ligue. Entre em contacto com o nosso Serviço de Assistência Técnica.

Este aparelho corresponde à classe 3, segundo a norma EN 30-1-1 para aparelhos a gás: aparelho encastrado num móvel.

Antes de instalar a sua nova placa de cozedura, certifique-se de que segue todas as instruções de montagem durante a instalação.

Este aparelho não pode ser instalado em iates ou caravanas.

Este aparelho deve ser apenas utilizado em locais com uma ventilação adequada.

Este aparelho não foi previsto para ser utilizado com um temporizador externo ou um telecomando externo.

Todos os trabalhos de instalação, ligação, regulação e adaptação a outros tipos de gás devem ser efectuados por um técnico autorizado, respeitando todas as regulamentações e legislação aplicáveis, bem como o estipulado pelas empresas locais fornecedoras de gás e electricidade. Deve prestar particular atenção às disposições aplicáveis relativamente à ventilação.

Este aparelho vem adaptado da fábrica para o tipo de gás indicado na placa de características. Caso seja necessário alterar o tipo de gás, consulte as instruções de montagem. Recomenda-se chamar o nosso Serviço de Assistência Técnica para a adaptação a outros tipos de gás.

Este aparelho foi unicamente concebido para utilização doméstica, não podendo, por isso,

ser utilizado para fins comerciais ou profissionais. Utilize o aparelho unicamente para cozinhar, nunca como aparelho de aquecimento. A garantia apenas será válida caso o aparelho seja utilizado correctamente e para os fins a que se destina.

O aparelho foi concebido para ser utilizado até a uma altitude de 2000 metros acima do nível do mar, no máximo.

Não deixe o aparelho a funcionar sem vigilância.

Não utilize tampas ou barreiras de protecção, para crianças, que não sejam recomendadas pelo fabricante da placa de cozedura. Podem provocar acidentes, por ex. devido ao sobreaquecimento, ignição ou libertação de fragmentos de materiais.

Este aparelho pode ser usado por crianças com mais de 8 anos e por pessoas com limitações físicas, sensoriais ou mentais ou com pouca experiência ou conhecimentos, se estiverem sob vigilância de uma pessoa responsável pela sua segurança ou tiverem sido instruídas acerca da utilização segura do aparelho e tiverem compreendido os perigos decorrentes da sua utilização.

As crianças não devem brincar com o aparelho. As tarefas de limpeza e manutenção por parte do utilizador não devem ser efectuadas por crianças, a não ser que tenham mais de 15 anos e estejam sob vigilância.

As crianças menores de 8 anos devem manter-se afastadas do aparelho e do cabo de ligação.

Instruções de segurança importantes

Aviso – Perigo de deflagração!

A acumulação do gás que não é queimado, num espaço fechado, pode causar deflagração. Não submeta o aparelho a correntes de ar. Os queimadores poderiam apagar-se. Leia atentamente as instruções e advertências relativas ao funcionamento dos queimadores a gás.

Aviso – Perigo de intoxicação!

A utilização de um aparelho de cozedura a gás produz calor, humidade e produtos de combustão no local onde está instalado. Garanta uma boa ventilação na cozinha, especialmente enquanto a placa de cozedura estiver em funcionamento: mantenha as aberturas de ventilação natural abertas ou instale um dispositivo de ventilação mecânica (campânula com exaustor). A utilização intensa e prolongada do aparelho pode requerer uma ventilação complementar ou mais eficaz: abra uma janela ou aumente a potência da ventilação mecânica.

Aviso – Perigo de queimaduras!

- As zonas de cozedura e zonas adjacentes aquecem muito. Nunca toque nas superfícies quentes. Mantenha as crianças com menos de 8 anos afastadas do aparelho.
- Quando a garrafa de gás de petróleo liquefeito (GPL) não está na vertical, pode passar propano/butano líquido para o aparelho, podendo originar labaredas intensas nos queimadores. Os componentes poderão ser danificados e, com o tempo, deixar de vedar correctamente, permitindo a saída descontrolada de gás. Qualquer destas situações pode provocar queimaduras. Coloque sempre garrafas de GPL na posição vertical.

Aviso – Perigo de incêndio!

- As zonas de cozedura aquecem muito. Não coloque objectos inflamáveis sobre a placa de cozedura. Não deixe objectos sobre a placa de cozedura.
- Não armazene nem utilize produtos químicos corrosivos, vapores, materiais inflamáveis ou produtos não alimentares por baixo deste electrodoméstico, nem perto dele.

- As gorduras ou óleos sobreaquecidos são facilmente inflamáveis. Não se ausente enquanto estiver a aquecer gorduras ou óleos. Se se inflamarem, não apague o fogo com água. Cubra o recipiente com uma tampa para apagar o fogo e desligue a zona de cozedura.

⚠ Aviso – Perigo de ferimentos!

- Fissuras ou fraturas na placa de vidro são perigosos. Desligue imediatamente todos os queimadores e elementos de aquecimento elétricos. Retire a ficha da tomada ou desligue o fusível na caixa de fusíveis. Feche a alimentação de gás. Não toque na superfície do aparelho. Nunca ligue um aparelho defeituoso. Contacte a assistência técnica.
- As mudanças repentinas de temperatura podem fazer com que o vidro se parta. Evite as correntes de ar e derramar líquidos frios durante a utilização da placa de cozedura.
- Os recipientes que apresentem danos, com um tamanho inadequado, que ultrapassem as margens da placa de cozedura ou que estejam mal posicionados, podem provocar graves lesões. Tenha em consideração as recomendações e advertências relativas aos recipientes para cozinhados.
- As reparações indevidas são perigosas. As reparações e substituições de condutores de corrente e tubagens do gás danificados só podem ser efectuadas por técnicos especializados do serviço de assistência técnica. Se o aparelho estiver avariado, desligue a ficha da tomada ou desligue o disjuntor no quadro eléctrico e feche a alimentação de gás. Contacte o serviço de assistência técnica.
- Se não for possível rodar um botão de comando ou se ele estiver solto, não pode continuar a utilizá-lo. Dirija-se de imediato ao serviço de assistência técnica, para que o botão de comando seja reparado ou substituído.

⚠ Aviso – Perigo de descarga eléctrica!

- Não utilize máquinas de limpeza a vapor para limpar o aparelho.
- Se a placa de vidro estiver estalada ou apresentar falhas, pode dar origem a choques eléctricos. Desligue o disjuntor no quadro eléctrico. Contacte o serviço de assistência técnica.

Conhecer o aparelho

Na visão geral de modelos poderá encontrar o seu aparelho com as potências dos queimadores.
→ *Página 2*

Elementos de comando e queimador

Em qualquer comando está identificado o queimador correspondente. Com os comandos pode regular, de acordo com as diferentes posições, a potência necessária entre os valores máximos e mínimos. Nunca tente mudar da posição 0 diretamente para a posição 1 ou da posição 1 para a posição 0.

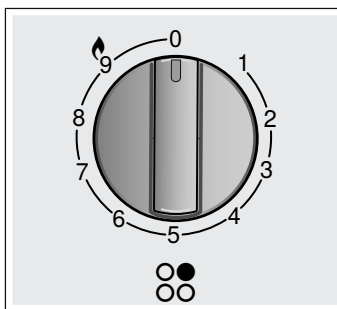

Indicações

	Queimador controlado pelo comando
0	Queimador desligado
9	Nível de potência máximo e ignição elétrica
1	Nível de potência mínimo

Para um funcionamento correcto do aparelho é importante certificar-se de que as grelhas e todas as peças dos queimadores estão correctamente colocadas. Não troque as tampas dos queimadores.

Remover as grelhas sempre com cuidado. A deslocação de uma grelha pode deslocar as grelhas adjacentes.

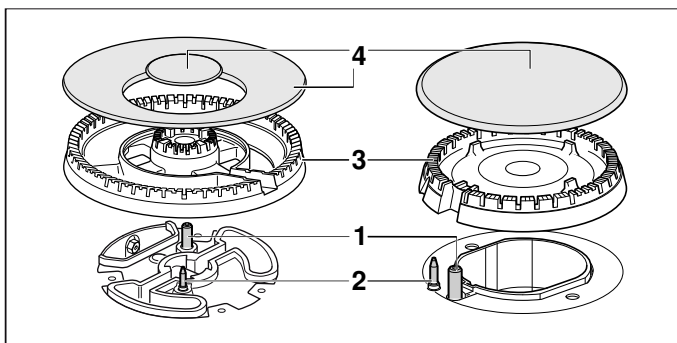

Elemento

1	Ficha
2	Elemento térmico
3	Boca do queimador
4	Tampa do queimador

Queimadores a gás

Ligação manual

1. Pressione os comandos do queimador selecionado e gire-os para a esquerda, até ao nível de potência mais elevado.
2. Chegue um acendedor ou uma chama (isqueiro, fósforo, etc.) ao queimador.

Ignição automática

Se a sua placa de cozinhar possuir ignição automática (fichas):

1. Pressione os comandos do queimador selecionado e gire-os para a esquerda, até ao nível de potência mais elevado. Enquanto mantiver os comandos pressionados, sairão faíscas de todos os queimadores. O queimador acende-se.
2. Solte os comandos.
3. Gire os comandos para a posição desejada.

Se não houver ignição, desligue o queimador e repita os passos descritos anteriormente. Desta vez mantenha os comandos pressionados durante mais tempo (até 10 segundos).

Aviso – Perigo de detonação!

Se o queimador não se acender após 15 segundos, desligue os comandos e abra a porta ou a janela do compartimento. Aguarde, pelo menos, um minuto, antes de acender novamente o queimador.

Conselho: Garanta a máxima limpeza. Se as fichas estiverem sujas, pode ocorrer uma ignição incorreta. Limpe as fichas regularmente com uma escova pequena, não metálica. Preste atenção para que as fichas não sejam sujeitas a impactos fortes.

Sistema de segurança

Esta placa de cozedura dispõe de um sistema de segurança (termopar) que impede a passagem do gás se os queimadores se apagarem acidentalmente.

Para garantir que este aparelho está activado:

1. Acenda o queimador normalmente.
2. Sem soltar o comando, mantenha-o firmemente pressionado durante 4 segundos após a chama se ter acendido.

Apagar um queimador

Rode o comando correspondente para a direita até à posição 0.

Alguns segundos depois de se apagar o queimador, emitir-se-á um som (som seco). Tal não é sinónimo de avaria, significa apenas que a segurança está desactivada.

Advertências

Durante o funcionamento do queimador, é normal que um ligeiro silvo seja emitido.

Quando utilizado inicialmente é normal que sejam libertados odores. Tal não constitui qualquer perigo nem é sinónimo de avaria. Os odores vão desaparecendo.

Uma chama cor-de-laranja é normal. Deve-se à presença de partículas de pó no ar, líquidos derramados, etc.

No caso de uma extinção acidental da chama do queimador, desligue o comando de accionamento do e não tente reacendê-lo durante, pelo menos, 1 minuto.

Tabelas e sugestões

Recipientes apropriados

Queimadores	Diâmetro mínimo da base do recipiente para cozinhar	Diâmetro máximo da base do recipiente para cozinhar
Queimador para wok	22 cm	30 cm
Queimador rápido	20 cm	26 cm
Queimador normal	14 cm	22 cm
Queimador económico	12 cm	16 cm

O recipiente não pode sobressair da margem da placa.

Advertências para utilização

As seguintes recomendações ajudá-lo-ão a poupar energia e a evitar danos nos recipientes:

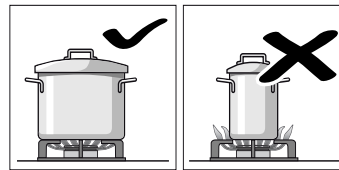

Utilize recipientes de tamanho adequado a cada queimador. Não utilize recipientes pequenos em queimadores grandes. A chama não deve tocar nos lados do recipiente.

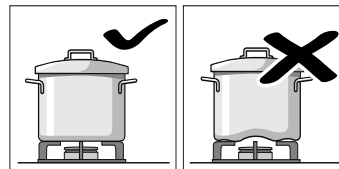

Não utilize recipientes deformados que não fiquem estáveis sobre a placa de cozedura. Os recipientes poderiam virar-se.

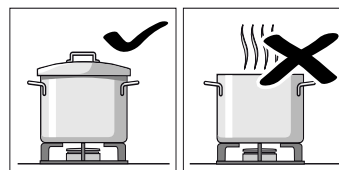

Utilize apenas recipientes de base plana e grossa.

Não deve cozinhar sem tampa ou com a tampa mal colocada. Grande parte da energia é desperdiçada.

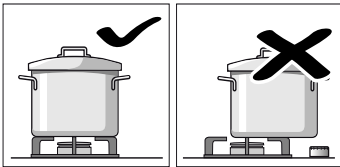

Coloque o recipiente bem centrado sobre o queimador. Caso contrário, o recipiente poderá virar-se. Não coloque os recipientes grandes sobre os queimadores próximos dos comandos. Estes podem ficar danificados devido ao excesso de temperatura.

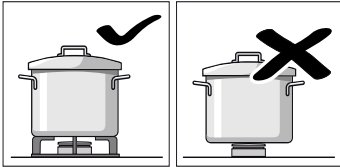

Coloque os recipientes sobre as grelhas e nunca directamente sobre o queimador. Antes de utilizar, certifique-se de que as grelhas e as tampas dos queimadores estão bem colocadas.

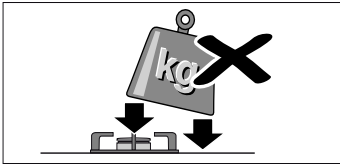

Manuseie os recipientes com cuidado sobre a placa de cozedura. Não golpee a placa de cozedura, nem coloque pesos excessivos sobre a mesma.

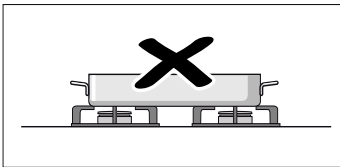

Não utilize dois queimadores ou fontes de calor para um só recipiente. Evite a utilização prolongada de grelhadores, caçarolas de barro, etc. na potência máxima.

Tabela com tempos e potências de cozedura

A seguinte tabela inclui as potências e os tempos de cozedura ideais para diferentes pratos. Os dados indicados são valores de referência para quatro porções.

Os tempos e as potências de cozedura dependem do tipo, peso e qualidade dos alimentos, do tipo de gás usado bem como do material do recipiente para cozinhar. Para a preparação deste pratos foram usados principalmente recipientes para cozinhar em aço inoxidável.

Utilize recipientes para cozinhar de tamanho adequado e coloque-os no centro do queimador. Consulte informações sobre o diâmetro do recipiente para cozinhar em. → "Recipientes apropriados"

Informações sobre a tabela

A preparação de cada prato é composta por um ou dois passos. Cada passo inclui informações sobre:

- Método de cozedura
- Potência de cozedura
- Tempo de duração em minutos

Métodos de cozedura indicados na tabela

- Ferver
- Retomar a cozedura
- Formar pressão na panela de pressão
- Manter pressão na panela de pressão
- Alourar bem
- Alourar levemente
- Derreter
- * Sem tampa
- ** Mexer constantemente

Conselho: Os símbolos não surgem no aparelho. Servem de orientação para os diferentes métodos de cozedura.

Na tabela são indicados dados para a preparação de pratos em diferentes queimadores. A opção recomendada é o primeiro queimador mencionado. Na visão geral de modelos são descritos todos os queimadores da placa de cozinhar. → *Página 2*

Exemplo:

Prato	Tempo total em min.	Passo 1			Passo 2		
Queimadores							
Sopas, sopas cremosas							
Sopa de peixe							
Q. rápido	12-17		8	7-9		1	5-8
Q. normal	17-22		8	11-13		1	6-9
Queimador wok	10-15		9	6-8		4	4-7

























































Este exemplo mostra a preparação de sopa de peixe com o queimador rápido, queimador normal e queimador wok.

Com o queimador rápido (opção recomendada) o tempo de cozedura alcança 12 a 17 minutos.

- Passo 1: Ferver. Regule 7-9 minutos na potência de cozedura 8.
- Passo 2: Retomar a cozedura. Para 5-8 minutos mudar para a potência de cozedura 1.

As indicações também são válidas para os outros queimadores sugeridos.

Prato	Tempo total em min.	Passo 1			Passo 2		
Queimadores							
Sopas, sopas cremosas							
Sopa de peixe							
Q. rápido	12-17		8	7-9		1	5-8
Q. normal	17-22		8	11-13		1	6-9
Queimador wok	10-15		9	6-8		4	4-7
Creme de abóbora, sopa Borscht							
Q. rápido	30-35		9	10-12		5	20-23
Q. normal	45-50		9	15-17		6	30-33
Queimador wok	25-30		9	8-10		2	17-20

Prato	Tempo total em min.	Passo 1			Passo 2		
							
Minestrone (sopa de legumes)							
Q. rápido	47-52		9	10-12		5	37-40
Q. normal	57-62		9	10-12		6	47-50
Queimador wok	43-48		8	8-10		3	35-38
Massas e arroz							
Esparguete							
Q. rápido	18-22	 *	9	8-10		6	10-12
Q. normal	20-24	 *	9	10-12		7	10-12
Queimador wok	18-22	 *	8	8-10		6	10-12
Arroz							
Q. rápido	17-22		9	5-7		2	12-15
Q. normal	18-23		9	7-9		6	11-14
Queimador wok	15-20		8	4-6		2	11-14
Ravioli							
Q. rápido	9-14		9	4-6		6	5-8
Q. normal	17-22		8	12-14		8	5-8
Queimador wok	10-15		8	5-7		8	5-8
Legumes e leguminosas							
Batatas cozidas (puré, salada de batata)							
Q. rápido	23-28		9	8-10		5	15-18
Q. normal	25-30		9	10-12		6	15-18
Queimador wok	25-30		7	11-13		5	14-17
Humus (grão-de-bico cozido)							
Q. rápido	50-55		9	10-12		4	40-43
Q. normal	52-57		9	12-14		5	40-43
Queimador wok	47-52		7	10-12		5	37-40
Lentilhas							
Q. rápido	40-45		9	8-10		8	32-35
Q. normal	50-55		9	18-20		6	32-35
Queimador wok	45-50		6	20-22		4	25-28
Legumes fritos							
Q. rápido	12-17	 *	7	6-8	 *	6	6-9
Q. normal	15-20	 *	8	8-10	 *	7	7-10
Queimador wok	11-16	 *	7	6-8	 *	5	5-8
Legumes frescos salteados**							
Queimador wok	6-8	 *	9	6-8			
Q. rápido	6-8	 *	9	6-8			
Batatas fritas							
Queimador wok	15-20	 *	7	15-20			
Q. rápido	15-20	 *	9	15-20			
Q. normal	25-30	 *	9	25-30			

Prato	Tempo total em min.	Passo 1			Passo 2		
							
Ovos							
Xacuca							
Q. normal	15-20		9	10-12		4	5-8
Q. rápido	13-18		8	7-9		3	6-9
Queimador wok	15-20		6	11-13		4	4-7
Omeleta (1 porção)							
Q. normal	3-5	 *	8	3-5			
Q. rápido	2-4	 *	9	2-4			
Queimador wok	2-4	 *	5	2-4			
Tortilha espanhola							
Q. rápido	25-30	 *	9	25-30			
Queimador wok	18-23	 *	9	18-23			
Molhos							
Molho Béchamel**							
Q. económico	10-15	 *	6	2-4	 *	6	8-11
Q. normal	10-15	 *	5	2-4	 *	5	8-11
Queimador wok	3-8	 *	5	1-2	 *	5	2-6
Molho com queijo de pasta azul**							
Q. económico	4-6	 *	7	4-6			
Q. normal	3-5	 *	7	3-5			
Q. rápido	3-5	 *	5	3-5			
Molho napolitano							
Q. normal	18-23	 *	6	2-4	 *	4	16-19
Queimador wok	13-18	 *	7	1-3	 *	5	12-15
Q. rápido	15-20	 *	8	1-3	 *	6	14-17
Molho carbonara							
Q. normal	10-15	 *	6	5-7	 *	3	5-8
Q. rápido	8-13	 *	5	4-6	 *	3	4-7
Q. económico	10-15	 *	9	5-7	 *	5	5-8
Peixe							
Pescada romana							
Q. rápido	5-10	 *	8	5-10			
Q. normal	8-13	 *	9	8-13			
Queimador wok	4-9	 *	6	4-9			
Salmão assado							
Q. rápido	5-10	 *	7	2-4		1	3-6
Q. normal	5-10	 *	8	2-4		1	3-6
Queimador wok	7-12	 *	8	2-4		1	5-8
Moluscos							
Q. rápido	5-7		9	5-7			
Queimador wok	4-6		9	4-6			
Q. normal	10-12		9	10-12			

Prato	Tempo total em min.	Passo 1			Passo 2		
Carne							
Peito de pato (1 unid.)							
Q. normal	6-8	*	7	6-8			
Q. rápido	9-11	*	7	9-11			
Queimador wok	6-8	*	5	6-8			
Lombo de novilho, stroganoff							
Q. rápido	8-13	*	9	8-13			
Queimador wok	5-10	*	8	5-10			
Q. normal	12-17	*	9	12-17			
Escalopes de frango (8 filetes de peito de frango)							
Q. rápido	7-12	*	9	2-4	*	6	5-8
Queimador wok	7-12	*	9	2-4	*	6	5-8
Q. normal	7-12	*	9	7-12			
Carne picada (patês, almôndegas, molho à bolonhesa)							
Q. rápido	15-20	*	8	15-20			
Q. normal	20-25	*	9	20-25			
Queimador wok	15-20	*	6	15-20			
Produtos pré-confeccionados							
Croquetes congelados (16 unid.)							
Barrinhas de peixe congeladas (12 unid.)							
Q. rápido	6-10		8	6-10			
Queimador wok	5-9		8	5-9			
Q. normal	8-12		8	8-12			
Salsichas (12 unid.)							
Q. rápido	5-10		9	1-3		7	4-7
Q. normal	7-12		9	7-12			
Queimador wok	5-10		9	1-3		7	4-7
Salsichas (12 unid.)							
Q. normal	8-13		9	8-13			
Queimador wok	9-14		4	9-14			
Q. rápido	7-12		7	7-12			
Hambúrguer (4 unid.)							
Q. rápido	4-9	*	9	1-3	*	7	3-6
Queimador wok	4-9	*	9	1-3	*	7	3-6
Q. normal	5-10	*	9	1-3	*	8	4-7
Legumes congelados**							
Q. rápido	7-12	*	9	7-12			
Queimador wok	5-10	*	9	5-10			
Q. normal	12-17	*	9	12-17			
Pizza (20 cm de diâmetro)							
Queimador wok	4-8		1	4-8			
Q. rápido	16-20		1	16-20			
Q. normal	20-25		1	20-25			

Prato	Tempo total em min.	Passo 1			Passo 2		
Sobremesas							
Pudim de arroz**							
Q. normal	30-35	*	8	9-11	*	4	21-24
Q. económico	40-45	*	9	12-14	*	2	28-31
Queimador wok	35-40	*	7	11-13	*	1	24-27
Chocolate de leite							
Q. económico	10-14	*	1	10-14			
Q. normal	16-20	*	1	16-20			
Crepes (4 unid.)							
Q. rápido	17-22	*	7	1-3	*	5	16-19
Queimador wok	8-13	*	7	1-3	*	4	7-10
Q. normal	20-25	*	8	1-3	*	6	19-22
Pudim de pão							
Q. rápido	25-30		9	10-12		6	15-18
Queimador wok	23-28		9	8-10		7	15-18
Q. normal	27-32		9	10-12		7	17-20
Pudim espanhol**							
Q. rápido	3-8	*	5	3-8			
Q. normal	8-13	*	5	8-13			
Queimador wok	3-8	*	2	3-8			
Bolo de massa batida (em banho-maria)							
Q. rápido	35-40		9	35-40			
Queimador wok	40-45		9	40-45			
Q. normal	45-50		9	45-50			

Dicas para cozinhar

- Para preparar sopas de creme e leguminosas, utilize uma panela de pressão. O tempo de cozedura diminui claramente. Se utilizar uma panela de pressão, siga as instruções do fabricante. Insira todos os ingredientes logo no início.
- Coloque sempre uma tampa para cozinhar batatas e arroz. O tempo de cozedura diminui, assim, claramente. A água tem de ferver, antes de colocar massas, arroz ou batatas. Em seguida, adeque a potência de cozedura, para continuar a cozinhar.
- Para cozinhar em frigideira, aqueça primeiro o óleo. Assim que iniciar a cozedura, mantenha a temperatura constante, adequando a potência de cozedura se necessário. Ao preparar várias porções, aguarde até a temperatura ser novamente atingida. Vire os alimentos regularmente.
- Se cozinhar sopas, natas, lentilhas ou grão de bico, introduza todos os ingredientes ao mesmo tempo no recipiente para cozinhar.

Limpeza e manutenção

Limpeza

Deixe o aparelho arrefecer e limpe-o com uma esponja, água e detergente.

Depois de cada utilização, limpe a superfície dos respectivos elementos do queimador assim que o mesmo tiver arrefecido. Se forem deixados restos (alimentos ressequidos, gotas de gordura, etc.), por mínimos que sejam, estes irão ficar colados à superfície, sendo mais difíceis de remover. É necessário que os furos e as ranhuras estejam limpos para que a chama se forme correctamente.

O movimento de alguns recipientes pode deixar restos metálicos sobre as grelhas.

Limpe os queimadores e as grelhas com água e detergente e esfregue-os com uma escova não metálica.

Se as grelhas tiverem bases de borracha, tenha cuidado ao limpá-las. As bases podem soltar-se e a grelha pode riscar a placa de cozedura.

Seque sempre os queimadores e as grelhas completamente. Se houver água ou zonas húmidas, no início da cozedura, pode deteriorar o esmalte.

Depois da limpeza e secagem dos queimadores, verifique se as tampas estão bem colocadas sobre o difusor.

Atenção!

- Não tire os elementos de comando para limpar o aparelho. A entrada de humidade pode danificar o aparelho.
- Não utilize máquinas de limpeza a vapor. Poderá danificar a placa de cozedura.
- Nunca utilize produtos abrasivos, esfregões de aço, objectos cortantes, facas, etc. para remover restos de comida ressequidos da placa de cozedura.
- Não utilize facas, raspadores ou utensílios similares para limpar a união do vidro com as tampas dos queimadores, os perfis metálicos nem os painéis de vidro ou alumínio, se existentes.

Manutenção

Limpe imediatamente, em caso de derrame de líquidos. Desta forma, evita que restos de comida se agarrem, o que dificulta a limpeza.

Não deslize os recipientes sobre o vidro, já que poderia riscar-se. Pelo mesmo motivo, não deixe cair objectos duros ou pontiagudos sobre o vidro. Não golpeie as esquinas da placa de cozedura.

Os grãos de areia (provenientes, por exemplo, da limpeza de legumes e hortaliças) riscam a superfície do vidro.

O açúcar queimado ou outros alimentos com elevado teor de açúcar que tenham sido derramados, devem ser imediatamente limpos da zona de cozedura utilizando uma espátula de vidro.

Defeito: O que fazer?

Em alguns casos, as avarias ocorridas podem ser fáceis de eliminar. Antes de contactar o serviço de assistência técnica, tenha em atenção as seguintes indicações:

Anomalia	Causa possível	Solução
O funcionamento eléctrico geral está avariado.	Fusível defeituoso.	Verificar o fusível na caixa geral de fusíveis e substituir, caso esteja avariado.
	O interruptor termomagnético ou diferencial disparou.	Verificar se o interruptor termomagnético ou diferencial disparou no quadro de distribuição de energia.
O acendimento automático não funciona.	Podem existir restos de alimentos ou de produtos de limpeza entre as bugias e os queimadores.	Este espaço, entre a bugia e o queimador, deve estar limpo.
	Os queimadores estão molhados.	Secar cuidadosamente as tampas dos queimadores.
	As tampas dos queimadores estão mal colocadas.	Certificar-se de que as tampas estão correctamente colocadas.
	O aparelho não está ligado à terra, está mal ligado ou a tomada de terra está defeituosa.	Contactar o instalador eléctrico.
A chama do queimador não é uniforme.	As peças do queimador estão mal colocadas.	Colocar correctamente as peças sobre o queimador correspondente.
	As ranhuras do queimador estão sujas.	Limpar as ranhuras do queimador.
O fluxo de gás não parece normal ou não sai gás.	A passagem de gás está fechada por chaves intermédias.	Abrir as possíveis chaves intermédias.
	Se o gás for fornecido por uma botija, verificar se esta não está vazia.	Substituir a botija.

Anomalia	Causa possível	Solução
Há um cheiro a gás na cozinha.	Está uma torneira aberta.	Fechar as torneiras.
	Acoplamento incorrecto da botija.	Verificar se o acoplamento está correcto.
	Possível fuga de gás.	Fechar a torneira geral de segurança, arejar o espaço onde se encontra e contactar imediatamente um técnico de instalação autorizado para fazer a revisão e certificação da instalação. Voltar a utilizar o aparelho apenas quando tiver a certeza de que não existe qualquer fuga de gás na instalação ou no próprio aparelho.
O queimador desliga-se imediatamente após soltar o comando.	O comando não foi pressionado durante tempo suficiente.	Depois de o queimador estar aceso, manter o comando pressionado durante mais uns segundos.
	As ranhuras do queimador estão sujas.	Limpar as ranhuras do queimador.

Serviços Técnicos

Se solicitar o nosso Serviço de Assistência Técnica, deve indicar o número do produto (E-Nr.) e o número de fabrico (FD) do aparelho. Esta informação consta da placa de características, situada na parte inferior da placa de cozedura e na etiqueta do manual de utilização.

Os dados para contacto com todos os países encontram-se no índice dos Serviços Técnicos anexo.

Ordem de reparação e apoio em caso de anomalias PT 21 4250 740

Confie na competência do fabricante. Assim, poderá ter a certeza de que a reparação é executada por técnicos especializados com a devida formação e com as peças de reparação originais para o seu aparelho.

Condições de garantia

Se, contrariamente às nossas expectativas, o aparelho apresentar algum dano ou se não cumprir com as exigências de qualidade previstas, solicitamos que nos comunique o mais rápido possível. Para que o serviço de garantia seja válido, o aparelho não deverá ter sido manipulado, nem submetido a uma má utilização.

As condições de garantia vigentes são as estabelecidas pelo representante da nossa empresa no país onde se realizou a compra. Informações pormenorizadas podem ser obtidas nos pontos de venda. É necessário apresentar o comprovativo de compra para beneficiar do serviço de garantia.

Reserva-se o direito de realizar alterações.

Protecção do meio ambiente

Se o símbolo  estiver na placa de características do aparelho, tenha em atenção as seguintes indicações.

Eliminação ecológica

Elimine a embalagem de forma ecológica.



Este aparelho está marcado em conformidade com a Directiva 2012/19/UE relativa aos resíduos de equipamentos eléctricos e electrónicos (waste electrical and electronic equipment - WEEE).

A directiva estabelece o quadro para a criação de um sistema de recolha e valorização dos equipamentos usados válido em todos os Estados Membros da União Europeia.

A embalagem do seu aparelho foi fabricada com os materiais estritamente necessários para garantir uma protecção eficaz durante o transporte. Estes materiais são totalmente recicláveis, sendo assim reduzido o impacto ambiental. Convidamo-lo a participar também na conservação do meio ambiente, cumprindo com as seguintes recomendações:

- deposite a embalagem no contentor de reciclagem adequado,
- antes de se desfazer de qualquer aparelho, inutilize-o. Consulte a administração local para saber o endereço do centro de recolha de materiais recicláveis mais próximo e entregue aí o seu aparelho,
- não deite fora o óleo utilizado pelo lava-louça. Guarde-o num recipiente fechado e entregue-o num centro de recolha ou, na sua falta, deposite-o num contentor de lixo orgânico (acabará por ser depositado num aterro controlado; provavelmente não é a melhor solução, mas desta forma evitamos a contaminação da água.

İçindekiler

	Amacına uygun kullanım	31
	Önemli güvenlik uyarıları	32
	Cihazı tanıyınız	33
	Kumanda elemanları ve brülör	33
	Gaz brülörleri	34
	Manuel olarak açılması	34
	Otomatik ateşleme	34
	Emniyet sistemi	34
	Brülörün kapatılması	34
	Uyarılar	34
	Tablo ve öneriler	34
	Uygun kaplar	34
	Kullanım Uyarıları	34
	Pişirme tablosu	35
	Temizlenmesi ve bakıma tabi tutulması	38
	Temizlik	38
	Bakım	38
	Arıza halinde ne yapmalı?	38
	Yetkili servisin çağırılması	39
	Garanti koşulları	39
	Çevre koruma	39
	AEEE Yönetmeliğine Uyum ve Atık Ürünün Elden Çıkarılması	39

Amacına uygun kullanım

Talimatları dikkatle okuyunuz. Ancak bu şekilde cihazın etkin ve güvenli kullanımı mümkün olacaktır. Kullanım ve kurulum talimatlarını saklayınız ve cihazın sahibinin değişmesi durumunda cihazla birlikte veriniz.

Bu kılavuzdaki kurallara uyulmadığı takdirde, üretici herhangi bir sorumluluktan muaf olacaktır.

Bu talimatlarda yer alan resimler bilgilendirme amaçlıdır.

Ürün yerleştirilene kadar koruyucu ambalajı çıkarmayınız. Cihazda herhangi bir hasar fark ettiğiniz takdirde cihazı çalıştırmayınız. Teknik Servisimiz ile irtibata geçiniz.

Bu EN 30-1-1 gazlı cihazlar normuna göre 3. sınıf bir cihazdır: mobilyaya gömme cihaz.

Yeni pişirme tezgahınızı kurmadan önce kurulumun montaj talimatlarına uygun gerçekleştirildiğinden emin olunuz.

Bu cihaz yat veya karavanlara kurulamaz.

Bu cihaz yalnızca yeterince havalandırılan yerlerde kullanılmalıdır.

Bu cihaz harici bir zamanlayıcı veya uzaktan kumanda ile kullanılmak üzere tasarlanmamıştır.

Bütün kurulum, bağlantı, ayarlama ve gaz tipine göre uyarılama işlemleri yetkili bir kurulum teknisyeni tarafından, ülkedeki standartlara ve yürürlükteki kanuni yönergeler ile yerel gaz ve elektrik tedarikçisi şirketin talimatlarına uygun olarak gerçekleştirilmelidir. Havalandırma ile ilgili geçerli düzenlemelere özel bir dikkat gösterilecektir.

Bu cihaz, fabrikadan özellikler tablosunda belirtilen gaz tipine ayarlı olarak çıkar. Gerekirse değiştiriniz, montaj talimatlarına uyunuz. Diğer gaz tiplerine uyarılama gerektiğinde Teknik Servisimizi çağırmanız önerilir.

Bu cihaz evde kullanım için tasarlanmıştır, ticari veya profesyonel amaçlarla kullanılamaz. Cihazı kesinlikle ısınma amacı ile kullanmayınız, sadece pişirme için kullanınız. Garanti sadece tasarım amacına uygun kullanılması durumunda geçerlidir.

Bu cihaz, deniz seviyesinden en fazla 2000 metre yükseklikte kullanılmak üzere tasarlanmıştır.

Çalışma sırasında cihazı kontrolsüz bir şekilde bırakmayınız.

Çocuklar için, pişirme tezgahı üreticisi tarafından önerilmemiş kapaklar veya bariyerler kullanmayınız. Örn. aşırı ısınma, alev alma veya malzeme parçalarının kopması dolayısıyla kazalara yol açabilirler.

Bu cihaz 8 yaşından küçük çocuklar, sınırlı fiziksel, zihinsel ve duygusal yeteneklere sahip kişiler ve eksik tecrübe veya bilgi sahibi kişiler tarafından ancak sorumlu bir kişinin denetimi altında olmaları veya kendilerine cihazın güvenli kullanımı ve ortaya çıkabilecek tehlikeler hakkında bilgi verilmiş olması durumunda kullanılabilir.

Çocuklar cihazla oynamamalıdır. Temizlik ve kullanıcı bakımı çocuklar tarafından yapılamaz; ancak 15 yaşından büyük çocuklar denetim altında yapabilir.

8 yaşından küçük çocukları cihazdan ve bağlantı kablosundan uzak tutunuz.

Önemli güvenlik uyarıları

Uyarı – Yangın tehlikesi!

Kapalı bir ortamda yanma olmaksızın gaz birikimi yangın tehlikesine yol açar. Cihazı hava akımına maruz bırakmayınız. Brülörler sönebilir. Gaz brülörlerinin çalışmasıyla ilgili talimatları ve uyarıları dikkatle okuyunuz.

Uyarı – Zehirlenme tehlikesi!

Gazlı bir pişirme cihazının kullanımı, kurulu olduğu yerde ısı, nem ve yanma ürünleri üretir. Özellikle cihazınız çalışır durumdayken mutfağın iyi havalandırılmasını sağlayınız: Tüm doğal havalandırma kanallarını açık tutunuz veya mekanik bir havalandırma (havalandırma fanı) cihazı kurunuz. Cihazın yoğun bir şekilde ve uzun süre kullanımı, tamamlayıcı veya daha etkili bir havalandırma gerektirebilir: Bir pencere açınız veya mekanik havalandırmanın gücünü arttırınız.

Uyarı – Yanma tehlikesi!

- Pişirme bölümleri ve etrafındakiler çok ısınır. Sıcak yüzeylere kesinlikle dokunmayınız. 8 yaşından küçük çocukları uzak tutunuz.
- LPG dik konulmadığı takdirde sıvı haldeki Propan/Butan cihaz içerisine girebilir. Bu sebeple brülörlerde ani alev oluşabilir. Parçalar zarar görebilir ve zamanla kontrol edilemeyen gaz çıkışlarına sebep olacak sızdırma problemleri ortaya çıkabilir. Her ikisi de yanmaya neden olabilir. LPG tüpleri her zaman dik konumda kullanınız.

Uyarı – Yangın tehlikesi!

- Pişirme bölümleri çok ısınır. Pişirme tezgahının üzerine yanıcı cisimler yerleştirmeyiniz. Pişirme tezgahı üzerinde eşya bırakmayınız.
- Bu elektrikli ev aletinin yakınında aşındırıcı, buharlaştırıcı kimyasal ürünler, yanıcı materyaller, besin dışında ürünler bulundurmuyunuz ve kullanmayınız.
- Aşırı ısınmış katı ya da sıvı yağlar kolay alev alır. Yağ kızdırırken ocaktan uzaklaşmayınız. Alev alması halinde ateşi su ile söndürmeyiniz. Ateşi söndürmek için kabı bir kapakla kaplayınız ve pişirme bölümünü kapatınız.

⚠ Uyarı – Yaralanma tehlikesi!

- Cam plakadaki çatlaklar veya kırıklar tehlikelidir. Tüm ocakları ve elektrikli ısıtıcı parçaları gecikmeden kapatınız. Elektrik fişini çekiniz veya sigorta kutusundaki sigortayı kapatınız. Gaz beslemesini kapatınız. Cihaz yüzeyine dokunmayınız. Arızalı bir cihazı kesinlikle açmayınız. Yetkili servisi çağırınız.
- Ani sıcaklık değişiklikleri camın kırılmasına yol açabilir. Pişirme tezgahının kullanımı sırasında, soğuk sıvıların dökülmemesine ve hava akımlarının olmamasına dikkat ediniz.
- Hasarlı, uygun boyuta sahip olmayan, pişirme tezgahının sınırlarını aşan veya kötü yerleştirilmiş kaplar ciddi yaralanmalara sebebiyet verebilir. Pişirme kaplarıyla ilgili tavsiye ve uyarılara uyunuz.
- Usulüne aykırı onarımlar tehlike teşkil eder. Onarımlar yalnızca tarafımızca eğitilen müşteri hizmetleri teknisyenleri tarafından gerçekleştirilmeli ve hasarlı akım ve gaz hatları değiştirilmelidir. Cihaz arızalıysa elektrik fişini çekiniz veya sigorta kutusundan sigortayı kapatınız, gaz beslemesini kapatınız. Müşteri hizmetlerini arayınız.
- Eğer bir kontrol düğmesi döndürülemiyor veya gevşetilemiyorsa kullanılmamalıdır. Kontrol düğmesini tamir etmek veya değiştirmek için derhal müşteri hizmetlerine başvurunuz.

⚠ Uyarı – Elektrik çarpma tehlikesi!

- Cihazı temizlemek için buharlı temizleme makinesi kullanmayınız.
- Cam plakada oluşan çatlama veya kırılmalar elektrik çarpmasına neden olabilir. Sigortayı sigorta kutusundan kapatınız. Müşteri hizmetlerini arayınız.

👁 Cihazı tanıyınız

Modele genel bakış içinde cihazınızı ve ocak güçlerini bulabilirsiniz. → Sayfa 2

Kumanda elemanları ve brülör

Her kumanda düğmesinde ilgili brülör işaretlenmiştir. Kumanda düğmeleri üzerindeki farklı pozisyonları kullanarak ihtiyaç duyduğunuz gücü maksimum ve minimum değerler arasında istediğiniz gibi ayarlayabilirsiniz. Asla pozisyon 0'dan pozisyon 1'e veya pozisyon 1'den pozisyon 0'a geçmeyi denemeyiniz.

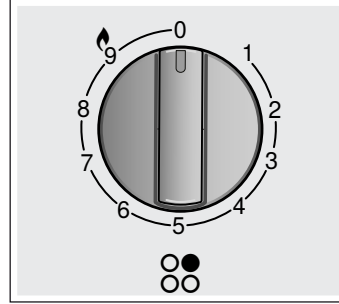
**Göstergeler**

🔥	Kumanda düğmesiyle kontrol edilen brülör
0	Kapalı brülör
9	En yüksek güç seviyesi ve elektrikli ateşleme
1	En düşük güç seviyesi

Cihazın doğru çalıştırılabilmesi için ızgaraların ve tüm brülör parçalarının doğru yerleştirildiğinden emin olunmalıdır. Brülör kapaklarının yerini değiştirmeyiniz.

İzgaraları her zaman dikkatlice çıkarınız. Bir ızgaranın kaydırılması, yandaki ızgaranın da aynı şekilde yerinin değişmesine neden olur.

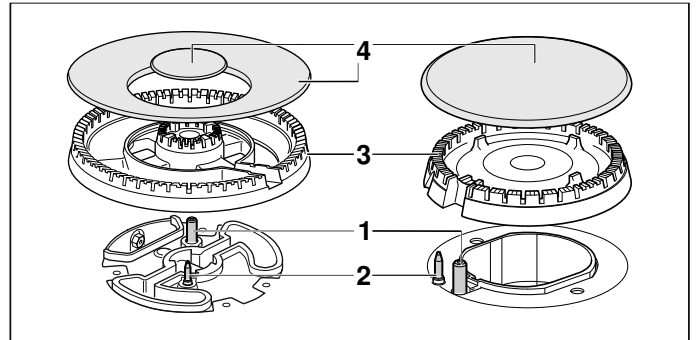
**Elemanlar**

1	Buji
2	Termik eleman
3	Brülör başlığı
4	Brülör kapağı

Gaz brülörleri

Manuel olarak açılması

1. Seçtiğiniz ocağın kumanda düğmesine basınız ve düğmeyi en yüksek güç seviyesine ulaşana kadar sola doğru döndürünüz.
2. Brülöre bir yakıcı veya bir alev (çakmak, kibrit vb.) yaklaştırınız.

Otomatik ateşleme

Eğer ocağınızda bir otomatik ateşleme mevcutsa (bujiler):

1. Seçtiğiniz ocağın kumanda düğmesine basınız ve düğmeyi en yüksek güç seviyesine ulaşana kadar sola doğru döndürünüz. Kumanda düğmesini basılı tuttuğunuz sürece tüm brülörlerin yanında kıvılcımlar çıkar. Brülör yanar.
2. Kumanda düğmesini serbest bırakınız.
3. Kumanda düğmesini istediğiniz pozisyona getiriniz.

Ateşleme gerçekleşmezse brülörü kapatınız ve tanımlanan adımları yeniden uygulayınız. Bu defa kumanda düğmesini daha uzun süre basılı tutunuz (azami 10 saniye).

Uyarı – Alev alma tehlikesi!

Eğer brülör 15 saniye sonunda yanmazsa kumanda düğmesini kapatınız ve içinde bulunduğunuz odanın kapısını veya penceresini açınız. Brülörü yeniden yakmadan önce en az bir dakika bekleyiniz.

Bilgi: Temizliğe çok dikkat ediniz. Bujiler kirlenmişse hatalı bir ateşleme yapılabilir. Bujileri düzenli olarak küçük, metalik olmayan bir fırçayla temizleyiniz. Bujilerin ciddi darbelere maruz kalmamasına dikkat ediniz.

Emniyet sistemi

Pişirme tezgahınız, brülörlerin kazayla yanması halinde gaz geçişini engelleyen bir emniyet sistemine (termo kupl) sahiptir.

Bu sistemin etkin olduğundan emin olmak için:

1. Brülörü normal olarak açınız
2. Kumanda düğmesini bırakmadan ateş yandıktan sonra kumandayı 4 saniye daha hafifçe basılı tutunuz.

Brülörün kapatılması

Kapatmak için kumanda düğmesini sağa çevirerek 0 pozisyonuna getiriniz.

Kapatıldıktan birkaç saniye sonra brülörden ses gelecektir (hafif tıkırtı). Bu herhangi bir anormallik değildir, emniyetin devre dışı olduğu anlamına gelir.

Uyarılar

Brülörün çalışması sırasında hafif bir ısıklık sesi duyulması normaldir.

İlk kullanımlarda koku gelmesi normaldir. Bu, herhangi bir risk ya da hatalı çalışma anlamına gelmez. Zamanla geçecektir.

Turuncu renkli alev normaldir. Havadaki tozdan, taşan sıvılardan vb. kaynaklanır.

Brülör alevlerinin yanlılıkla sönmesi durumunda brülörün kumanda düğmesini kapatınız ve en az 1 dakikadan önce yeniden yakmaya çalışmayınız.

Tablo ve öneriler

Uygun kaplar

Brülör	Piştirme kabı tabanının minimum çapı	Piştirme kabı tabanının maksimum çapı
Wok brülör	22 cm	30 cm
Güçlü brülör	20 cm	26 cm
Normal ocak	14 cm	22 cm
Ekonomik brülör	12 cm	16 cm

Kap ocağın kenarından dışarı taşmamalıdır.

Kullanım Uyarıları

Aşağıdaki öneriler enerji tasarrufuna ve kapların zarar görmesini önlemeye yardımcı olur:

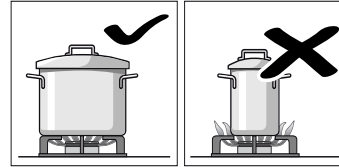

Her brülör için uygun ebatta kaplar kullanınız. Büyük brülörde küçük kaplar kullanmayınız. Alev, kapların yan taraflarına ulaşmamalıdır.

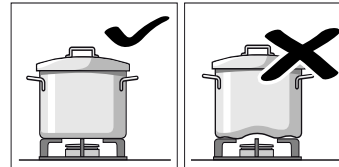

Piştirme tezgahı üzerine dengesizlik oluşturacak biçimi bozulmuş kaplar koymayınız. Kaplar devrilebilir. Yalnızca tabanı düz ve kalın olan kapları kullanınız.

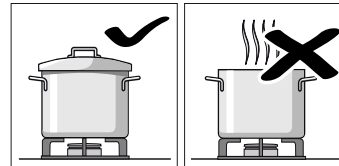

Kapaksız veya kapak yarı aralık olarak pişirmeyiniz. Enerjiyi boşa harcarsınız.

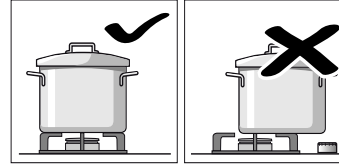

Kabı tam olarak brülör üzerinde ortalayınız, bir tarafına ağırlık vermeyiniz. Aksi durumda devrilebilir. Büyük kapları kumanda düğmelerinin yakınındaki brülörlere koymayınız. Aşırı sıcaktan dolayı hasara neden olabilir.

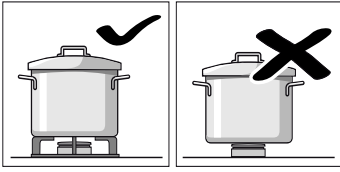

Kapları asla doğrudan brülörün üzerine değil, mutlaka ızgara üzerine yerleştiriniz. Cihazı çalıştırmadan önce, ızgaraların ve brülör kapaklarının doğru yerde olduğundan emin olunuz.

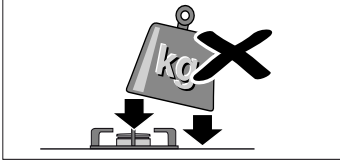

Pişirme tezgahındayken kapları dikkatli bir şekilde tutunuz. Pişirme tezgahına darbe gelmesine engel olunuz ve üzerine ağırlık yerleştirmeyiniz.

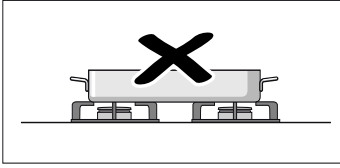

Kesinlikle bir tavayı ısıtmak için iki brülörü veya ısı kaynağını aynı anda kullanmayınız. Uzun süreli pişirmelerde maksimum ısıda, kavurma sacı ve toprak kap kullanmaktan kaçınınız.

Pişirme tablosu

Aşağıdaki tablo, farklı yemekler için optimum pişirme kademelerini ve pişirme sürelerini içerir. Bilgiler, dört porsiyon için referans değerlerdir.

Pişirme süreleri ve pişirme kademeleri, yiyeceklerin türüne, ağırlığına ve kalitesine göre değişebileceği gibi kullanılan gaz ve pişirme kabının malzemesine de bağlıdır. Bu yemeklerin hazırlanması için genelde paslanmaz çelik pişirme tavaları kullanılır.

Her zaman uygun büyüklükte pişirme tavaları kullanınız ve brülörün ortasına yerleştiriniz. Pişirme tavası çapına yönelik bilgileri → "Uygun kaplar" altında bulabilirsiniz.

Tabloya ilişkin bilgiler

Her bir yemeğin hazırlanması için bir veya iki adım gereklidir. Her adımda aşağıdaki konulara ilişkin bilgiler mevcuttur:

- Pişirme yöntemi
- Pişirme kademesi
- Dakika cinsinden süre

Tabloda belirtilen pişirme yöntemleri

- Pişirmek
- Pişirmeye devam edilmesi
- Dödüklü tencerede basınç oluşumu
- Dödüklü tencerede basıncın korunması
- Güçlü kızartma
- Hafif kızartma
- Eritme
- * Kapaksız
- ** Sürekli karıştırınız

Bilgi: Bu semboller cihaz üzerinde görünmez. Bunlar, farklı pişirme yöntemleri için yönlendirme amaçlıdır.

Farklı brülörler üzerinde yemekleri pişirmek için gerekli bilgiler görünür. Tavsiye edilen seçenek, ilk olarak bahsedilen brülördür. Modele genel bakışta ocaktaki tüm brülörler açıklanmıştır. → Sayfa 2

Örnek:

Yemek	Dakika olarak toplam süre	Adım 1	Adım 2
Brülör			
Çorbalar, kremalı çorbalar			
Balık çorbası			
Güçlü brülör	12-17	8	7-9 1 5-8
Normal brülör	17-22	8	11-13 1 6-9
Wok brülör	10-15	9	6-8 4 4-7

Bu örnekte güçlü brülör, normal brülör ve wok brülör ile balık çorbasının hazırlanışı gösterilmiştir.















































Güçlü brülör (önerilen seçenek) ile pişirme süresi 12 ile 17 dakika arasındadır.

- Adım 1: Kaynatma. 7-9 dakika için pişirme kademesi 8'i ayarlayınız.
- Adım 2: Pişirme. 5-8 dakika için pişirme kademesi 1'e geçiniz.







Bu bilgiler diğer önerilen brülörler için de geçerlidir.

Yemek	Dakika olarak toplam süre	Adım 1	Adım 2
Brülörler			
Çorbalar, kremalı çorbalar			
Balık çorbası			
Güçlü brülör	12-17	8	7-9 1 5-8
Normal brülör	17-22	8	11-13 1 6-9
Wok brülör	10-15	9	6-8 4 4-7
Kabak kreması, borç çorbası			
Güçlü brülör	30-35	9	10-12 5 20-23
Normal brülör	45-50	9	15-17 6 30-33
Wok brülör	25-30	9	8-10 2 17-20
Minestrone (sebze çorbası)			
Güçlü brülör	47-52	9	10-12 5 37-40
Normal brülör	57-62	9	10-12 6 47-50
Wok brülör	43-48	8	8-10 3 35-38
Makarna ve piring			
Spagetti			
Güçlü brülör	18-22	* 9	8-10 6 10-12
Normal brülör	20-24	* 9	10-12 7 10-12
Wok brülör	18-22	* 8	8-10 6 10-12
Pirinç			
Güçlü brülör	17-22	9	5-7 2 12-15
Normal brülör	18-23	9	7-9 6 11-14
Wok brülör	15-20	8	4-6 2 11-14
Ravioli			
Güçlü brülör	9-14	9	4-6 6 5-8
Normal brülör	17-22	8	12-14 8 5-8

Yemek Brülörler	Dakika olarak toplam süre	Adım 1			Adım 2		
							
Wok brülör	10-15		8	5-7		8	5-8
Sebze ve baklagiller							
Haşlanmış patates (püre, patates salatası)							
Güçlü brülör	23-28		9	8-10		5	15-18
Normal brülör	25-30		9	10-12		6	15-18
Wok brülör	25-30		7	11-13		5	14-17
Humus (nohut püresi)							
Güçlü brülör	50-55		9	10-12		4	40-43
Normal brülör	52-57		9	12-14		5	40-43
Wok brülör	47-52		7	10-12		5	37-40
Mercimek							
Güçlü brülör	40-45		9	8-10		8	32-35
Normal brülör	50-55		9	18-20		6	32-35
Wok brülör	45-50		6	20-22		4	25-28
Sebze kızartma							
Güçlü brülör	12-17		7	6-8		6	6-9
Normal brülör	15-20		8	8-10		7	7-10
Wok brülör	11-16		7	6-8		5	5-8
Taze sebze sote**							
Wok brülör	6-8		9	6-8			
Güçlü brülör	6-8		9	6-8			
Patates kızartması							
Wok brülör	15-20		7	15-20			
Güçlü brülör	15-20		9	15-20			
Normal brülör	25-30		9	25-30			
Yumurta							
Şakşuka							
Normal brülör	15-20		9	10-12		4	5-8
Güçlü brülör	13-18		8	7-9		3	6-9
Wok brülör	15-20		6	11-13		4	4-7
Omlet (1 porsiyon)							
Normal brülör	3-5		8	3-5			
Güçlü brülör	2-4		9	2-4			
Wok brülör	2-4		5	2-4			
İspanyol tortillası							
Güçlü brülör	25-30		9	25-30			
Wok brülör	18-23		9	18-23			
Soslar							
Beşamel sosu**							
Ekonomik b.	10-15		6	2-4		6	8-11
Normal brülör	10-15		5	2-4		5	8-11
Wok brülör	3-8		5	1-2		5	2-6

Yemek Brülörler	Dakika olarak toplam süre	Adım 1			Adım 2		
							
Küflü peynirli sos**							
Ekonomik b.	4-6		7	4-6			
Normal brülör	3-5		7	3-5			
Güçlü brülör	3-5		5	3-5			
Napoliten sos							
Normal brülör	18-23		6	2-4		4	16-19
Wok brülör	13-18		7	1-3		5	12-15
Güçlü brülör	15-20		8	1-3		6	14-17
Carbonara sosu							
Normal brülör	10-15		6	5-7		3	5-8
Güçlü brülör	8-13		5	4-6		3	4-7
Ekonomik b.	10-15		9	5-7		5	5-8
Balık							
Roma usulü barlam balığı							
Güçlü brülör	5-10		8	5-10			
Normal brülör	8-13		9	8-13			
Wok brülör	4-9		6	4-9			
Fırınlanmış somon							
Güçlü brülör	5-10		7	2-4		1	3-6
Normal brülör	5-10		8	2-4		1	3-6
Wok brülör	7-12		8	2-4		1	5-8
Midye							
Güçlü brülör	5-7		9	5-7			
Wok brülör	4-6		9	4-6			
Normal brülör	10-12		9	10-12			
Et							
Ördek göğsü (1 adet)							
Normal brülör	6-8		7	6-8			
Güçlü brülör	9-11		7	9-11			
Wok brülör	6-8		5	6-8			
Beef Strogonof							
Güçlü brülör	8-13		9	8-13			
Wok brülör	5-10		8	5-10			
Normal brülör	12-17		9	12-17			
Tavuk şnitel (8 tavuk göğüs filetosu)							
Güçlü brülör	7-12		9	2-4		6	5-8
Wok brülör	7-12		9	2-4		6	5-8
Normal brülör	7-12		9	7-12			
Kıyma (etli börek, köfte, bolonez sos)							
Güçlü brülör	15-20		8	15-20			
Normal brülör	20-25		9	20-25			
Wok brülör	15-20		6	15-20			

Yemek Brülörler	Dakika olarak toplam süre	Adım 1	Adım 2
Hazır ürünler			
Donmuş kroket (16 adet)			
Donmuş balık kroket (12 adet)			
Güçlü brülör	6-10		8 6-10
Wok brülör	5-9		8 5-9
Normal brülör	8-12		8 8-12
Sosis (12 adet)			
Güçlü brülör	5-10		9 1-3  7 4-7
Normal brülör	7-12		9 7-12
Wok brülör	5-10		9 1-3  7 4-7
Haşlanmış sosis (12 adet)			
Normal brülör	8-13		9 8-13
Wok brülör	9-14		4 9-14
Güçlü brülör	7-12		7 7-12
Hamburger (4 adet)			
Güçlü brülör	4-9		9 1-3  7 3-6
Wok brülör	4-9		9 1-3  7 3-6
Normal brülör	5-10		9 1-3  8 4-7
Dondurulmuş sebze**			
Güçlü brülör	7-12		9 7-12
Wok brülör	5-10		9 5-10
Normal brülör	12-17		9 12-17
Pizza (20 cm çap)			
Wok brülör	4-8		1 4-8
Güçlü brülör	16-20		1 16-20
Normal brülör	20-25		1 20-25
Tatlılar			
Sütlü çikolata			
Normal brülör	30-35		8 9-11  4 21-24
Ekonomik b.	40-45		9 12-14  2 28-31
Wok brülör	35-40		7 11-13  1 24-27
Sütlü çikolata			
Ekonomik b.	10-14		1 10-14
Normal brülör	16-20		1 16-20
Krep (4 adet)			
Güçlü brülör	17-22		7 1-3  5 16-19
Wok brülör	8-13		7 1-3  4 7-10
Normal brülör	20-25		8 1-3  6 19-22
Ekmekli puding			
Güçlü brülör	25-30		9 10-12  6 15-18
Wok brülör	23-28		9 8-10  7 15-18
Normal brülör	27-32		9 10-12  7 17-20

Yemek Brülörler	Dakika olarak toplam süre	Adım 1	Adım 2
İspanyol pudingi**			
Güçlü brülör	3-8		5 3-8
Normal brülör	8-13		5 8-13
Wok brülör	3-8		2 3-8
Kuru pasta (benmari usulü)			
Güçlü brülör	35-40		9 35-40
Wok brülör	40-45		9 40-45
Normal brülör	45-50		9 45-50

Pişirme ipuçları

- Kremalı çorbaları ve baklagilleri hazırlama sırasında düdüklü tencere kullanınız. Pişirme süresi belirgin biçimde azalır. Bir düdüklü tencere kullanacaksanız üreticisinin talimatlarına uyunuz. Başlangıçta tüm malzemeleri ekleyiniz.
- Patates ve pirinç pişirirken her zaman tencerenin kapağını kapatınız. Pişirme süresi böylece belirgin biçimde azalır. Makarnayı, pirinci veya patatesi ilave etmeden önce suyu kaynatmalısınız. Ardından pişirme işlemine devam etmek için pişirme kademesini ayarlayınız.
- Tava yemeklerinde ilk önce yağı ısıtınız. Kızartmaya başladıktan sonra gerekirse pişirme kademesini ayarlayarak sıcaklığı sabit tutunuz. Daha sonraki porsiyonları hazırlamak için pişirme sıcaklığına yeniden ulaşılan kadar bekleyiniz. Yiyecekleri düzenli aralıklarla çeviriniz.
- Çorba, kremalı çorba, mercimek veya nohut pişirecekseniz tüm malzemeleri aynı anda pişirme tenceresine ekleyiniz.

Temizlenmesi ve bakıma tabi tutulması

Temizlik

Cihaz soğuduktan sonra sünger, sabun ve su ile temizleyiniz.

Her kullanımdan sonra, soğumalarının ardından ilgili brülör elemanlarının yüzeyini temizleyiniz. Ne kadar az da olsa yüzey üzerinde artık (taşmış yemek, yağ damlaları vb.) bırakılması halinde, yüzeyin üzeri kaplanacak ve sonrasında bu katmanın temizlenmesi daha zor olacaktır. Ateşin doğru yanabilmesi için delik ve olukların temiz olması gerekir.

Bazı kapların hareketi ızgaralar üzerinde metal izleri bırakabilir.

Brülörleri ve ızgaraları sabunlu su ile temizleyiniz ve metal olmayan bir fırça ile fırçalayınız.

ızgaralar lastik tıparlarla yerleştirilmiş ise temizlerken dikkatli olunuz. Tıparlar sökülebilir ve ızgara pişirme tezgahını çizebilir.

Her zaman brülörleri ve ızgaraları tamamen kurutunuz. Pişirme işleminin başında su damlaları veya nemli bölgeler emayenin bozulmasına yol açabilir.

Brülörleri temizledikten ve kuruladıktan sonra, brülör kapaklarının alev dağıtıcılarının üzerine doğru bir şekilde yerleştirdiğinden emin olunuz.

Dikkat!

- Cihazın temizlenmesi sırasında kumanda elemanlarını çıkarmayınız. Cihazın neme maruz kalması hasara neden olabilir.
- Buharlı temizleme makinelerini kullanmayınız. Pişirme tezgahı zarar görebilir.
- Pişirme tezgahı üzerinde kalan yemek artıklarını çıkarmak için asla yanıcı ürünler, tel bezler, kesici aletler, bıçak vb. kullanmayınız.
- Brülör kapakları ile cam levha birleşimlerini, metalik yüzeyleri, varsa cam ya da alüminyum levhaları temizlemek için spatula veya benzeri şeyler kullanmayınız.

Bakım

Taşan sıvıları anında temizleyiniz. Böylece yemek artıklarının yapışmasını önleyebilirsiniz ve gereksiz yere güç sarf etmezsiniz.

Çizilme ihtimali yüzünden asla tavaları yüzey üzerinde kaydırmayınız. Buna ek olarak, camın üzerine ağır veya sert cisimleri düşürmemeye dikkat ediniz. Tencerenin hiçbir parçasını çarpmayınız.

Kum tanecikleri (örneğin temizlenen meyvelerden ve sebzelerden gelebilecek olanlar) cam yüzeyi çizebilir.

Erimiş şeker veya çok fazla şeker içeren yemekler pişirme bölümüne döküldükleri anda cam kazıma aleti ile çıkarılmalıdır.

? Arıza halinde ne yapmalı?

Beklenmeyen durumlar bazen kolaylıkla çözülebilir. Teknik Servisi aramadan önce aşağıdaki önerileri dikkate alınız:

Arıza	Olası neden	Çözüm
Genel elektrik sistemi çalışmıyor.	Arızalı sigorta.	Ana sigorta kutusunu kontrol ediniz ve sigorta arızalıysa değiştiriniz.
	Otomatik sigorta attı veya şalter indi.	Genel kumanda panosunda ana sigortanın veya şalterin atıp atmadığını kontrol ediniz.
Otomatik çakmak çalışmıyor.	Bujiler ile brülörler arasında yemek veya temizleyici artığı kalmış olabilir.	Buji ve brülör arasındaki boşluk temiz olmalıdır.
	Brülörler ıslak olabilir.	Brülör kapaklarını dikkatlice kurulayınız.
	Brülör kapakları düzgün yerleştirilmemiş olabilir.	Kapakların düzgün yerleştirildiğinden emin olunuz.
	Cihaz topraklanmamış, kötü bir bağlantı yapılmış veya topraklaması hatalı.	Bir elektrik teknisyeniyle temasa geçiniz.
Brülör alevi eşit değil.	Brülör parçaları düzgün yerleştirilmemiş olabilir.	Parçaları ilgili brülörlere doğru şekilde yerleştiriniz.
	Brülör boşlukları kirli.	Brülör boşluklarını temizleyiniz.
Gaz akışı normal gözüküyor veya gaz çıkmıyor.	Gaz geçişi gaz valfleri tarafından engellenmiş.	Tüm gaz valflerini açınız.
	Gaz, gaz tüpünden geliyorsa tüpün boş olmadığından emin olunuz.	Gaz tüpünü değiştiriniz.

Arıza	Olası neden	Çözüm
Mutfakta gaz kokusu var.	Bir vana açık kalmış olabilir.	Vanaları kapatınız.
	Gaz tüpünün kötü bağlanması.	Bağlantının doğru olduğundan emin olunuz.
	Olası gaz kaçağı.	Genel gaz anahtarını kapatın, ortamı havalandırın ve kurulumu gözden geçirmesi ve onaylaması için derhal bir yetkili kurulum teknisyenine haber veriniz. Kurulumda veya cihazda hiç gaz kaçağı olmadığından emin olana kadar cihazı kullanmayınız.
Düğme bırakıldıktan sonra brülör hemen kapanıyor.	Kumanda düğmesine yeterince uzun süre basılmamış olabilir.	Brülörü yakınız ve kumanda düğmesini birkaç saniye daha basılı tutunuz.
	Brülör boşlukları kirli.	Brülör boşluklarını temizleyiniz.

Yetkili servisin çağırılması

Teknik Servisimize ihtiyacınız varsa cihazın ürün numarasını (E-Nr.) ve üretim numarasını (FD) vermeniz gerekecektir. Bu bilgiyi pişirme tezgahının iç kısmında yer alan özellikler tablosunun üzerinde ve kullanım kılavuzunun etiketinde bulabilirsiniz.

Kullanım ömrü :10 yıldır (Ürünün fonksiyonunu yerine getirebilmesi için gerekli yedek parça bulundurma süresi)

Arızalarda onarım siparişi ve danışma

TR 444 6688

Çağrı merkezini sabit hatlardan aramanın bedeli şehir içi ücretlendirme, Cep telefonlarından ise kullanılan tarifeye göre değişiklik göstermektedir.

Üreticinin yetkisine güveniniz. Böylelikle gerekli onarım çalışmalarının, cihazınızın orijinal yedek parçalarına sahip, eğitilmiş servis teknisyenleri tarafından yapıldığından emin olabilirsiniz.

Garanti koşulları

Beklentilerimizin aksine, cihazda herhangi bir arıza meydana gelirse veya ihtiyaçları öngörülen kalitede karşılayamazsa lütfen bunu en kısa sürede bize bildirin. Garantinin geçerli olması için cihaza müdahale edilmemiş ve yanlış kullanılmamış olması gerekir.

Bu cihaz için uygulanan garanti koşulları, şirketimizin, cihazın satın alındığı ülkedeki temsilciliği tarafından belirlenir. Satış noktalarından ayrıntılı bilgi edinebilirsiniz. Garantinin geçerli olması için satış belgesinin bulundurulması gerekir.

Her türlü değişiklik hakkı saklıdır.

Çevre koruma

Özellikler tablosunda  sembolü görülüyorsa aşağıdaki göstergelere dikkat ediniz.

AEEE Yönetmeliğine Uyum ve Atık Ürünün Elden Çıkarılması

Ambalaj malzemesini çevre kurallarına uygun şekilde imha ediniz.



Bu ürün T.C. Çevre ve Şehircilik Bakanlığı tarafından yayımlanan "Atık Elektrikli ve Elektronik Eşyaların Kontrolü Yönetmeliği"nde belirtilen zararlı ve yasaklı maddeleri içermez. AEEE yönetmeliğine uygundur. Bu ürün, geri dönüşümlü ve tekrar kullanılabilir nitelikteki yüksek kaliteli parça ve malzemelerden üretilmiştir. Bu nedenle, ürünü, hizmet ömrünün sonunda evsel veya diğer atıklarla birlikte atmayın. Elektrikli ve elektronik cihazların geri dönüşümü için bir toplama noktasına götürün. Bu toplama noktalarını bölgenizdeki yerel yönetime sorun. Kullanılmış ürünleri geri kazanıma vererek çevrenin ve doğal kaynakların korunmasına yardımcı olun. Ürünü atmadan önce çocukların güvenliği için elektrik fişini kesin ve kilit mekanizmasını kırarak çalışmaz duruma getirin.

Cihazınızın ambalajı, nakliye sırasında etkin korumayı garanti etmek açısından çok gerekli olan malzemelerden üretilmiştir. Bu malzemeler tamamen geri dönüşebilir ve böylece çevreye verilen zarar azaltılmaktadır. Sizleri de aşağıdaki tavsiyelere uyararak çevrenin korunmasına katkıda bulunmaya davet ediyoruz:

- ambalajı uygun geri dönüşüm kutusuna atınız,
- cihazı hurdaya çıkarmadan önce kullanılmaz hale getiriniz. Bulduğunuz yerin yerel yönetimine, geri dönüşebilir malzemelerin toplandığı en yakın merkeze danışınız ve cihazınızı oraya ulaştırınız,
- kullanılmış yağı lavaboya dökmeyiniz. Yağı kapalı bir kaba koyarak çöp toplama noktasına veya bir çöp konteynerine bırakınız (kontrollü bir çöplüğe ulaşacaktır; bu en iyi çözüm olmasa da bu sayede suyun kirlenmesini engelleriz).



BSH Electrodomésticos España S.A.
Ronda del Canal Imperial de Aragón, 18-20
Parque empresarial Pla-Za 50197 Zaragoza, SPAIN

www.balay.es



9001132021
980125(C)
el, es, pt, tr