

# Your new dryer

**Congratulations** - You have chosen a modern, high-quality Bosch domestic appliance. The condensation dryer with heat pump and automatic cleaning of the heat exchanger is outstanding in terms of efficient energy consumption and low maintenance requirements → page 6. Every dryer which leaves our factory is carefully checked to ensure that it functions correctly and is in perfect condition. Should you have any questions, our after-sales service will be pleased to help.

## Disposal in an environmentally-responsible manner

This appliance is labelled in accordance with European Directive 2012/19/EU concerning used electrical and electronic appliances (waste electrical and electronic equipment - WEEE). The guideline determines the framework for the return and recycling of used appliances as applicable throughout the EU.

For further information about our products, accessories, spare parts and services, please visit: [www.bosch-home.com](http://www.bosch-home.com)

- Observe the safety instructions on page 13.
- Read these instructions and the separate **Energy-saving mode** instructions before operating the dryer.

## Contents

Preparation	2
Control panel	2
Drying	3/4
Display panel and settings	5
Notes on laundry	6
Important information	6
Overview of programmes	7
Care and cleaning	8
Installation	9
Frost protection / Transport	9
Optional accessories	10
Technical data	10
Consumption rates	10
Normal noises	11
What to do if	12
After-sales service	13
Safety instructions	13

# Intended use

- exclusively for domestic use,
  - only for drying fabrics which have been washed using water.
- Keep children younger than 3 years old away from the dryer. Do not let children make the cleaning and maintenance work on the dryer without supervision. Do not leave children unsupervised near the dryer. Keep pets away from the dryer. The dryer may be operated by children from 8 years of age, by persons who have limited physical, sensory or mental abilities and by persons who have inadequate experience or knowledge, provided they are supervised or have been instructed by a responsible person. This appliance is intended for use up to a maximum height of 4000 metres above sea level.**

## Programmes / Fabrics

Detailed overview of the programmes and fabrics → Programme overview, page 7. Observe the care instructions on the care label.

<b>Cottons</b>	Hard-wearing fabrics.
<b>Easy-Care</b>	Fabrics made from synthetic or blended fabrics.
<b>Dryness levels to select with the Cottons and Easy-Care programmes:</b>	
<b>Cupboard Dry Plus</b>	Thick and multi-layered fabrics.
<b>Cupboard Dry</b>	Single-layered laundry.
<b>Iron Dry</b>	Laundry suitable for ironing after drying.
<b>Sportswear</b>	Functional clothing made of microfibre.
<b>Towels</b>	Terry-towelling laundry e.g. towels and bathrobes.
<b>Mixed Load</b>	A mixed load of fabrics made of cotton and synthetic fabrics.
<b>Timed Programme warm</b>	} All types of fabric; time programme.
<b>Timed Programme cold</b>	
<b>Shirts</b>	Cotton or linen fabrics that are still damp and easy-care fabrics.
<b>Super Quick 40'</b>	Synthetics, cotton or blended fabrics.
<b>Down Wear</b>	Fabrics with down filling.
<b>Wool finish</b>	Woollen fabrics that are suitable for use in washers.

# Preparation

Installation → page 9.

- Never start the dryer if it is damaged! Inform your after-sales service!**
- Make sure your hands are dry. Only grasp the plug by the plug body.**
- Remove all items from pockets, especially cigarette lighters. The drum must be empty prior to loading.**
- See also separate instructions for "Woollens basket" (depending on model).**

## Set and adjust the programme individually

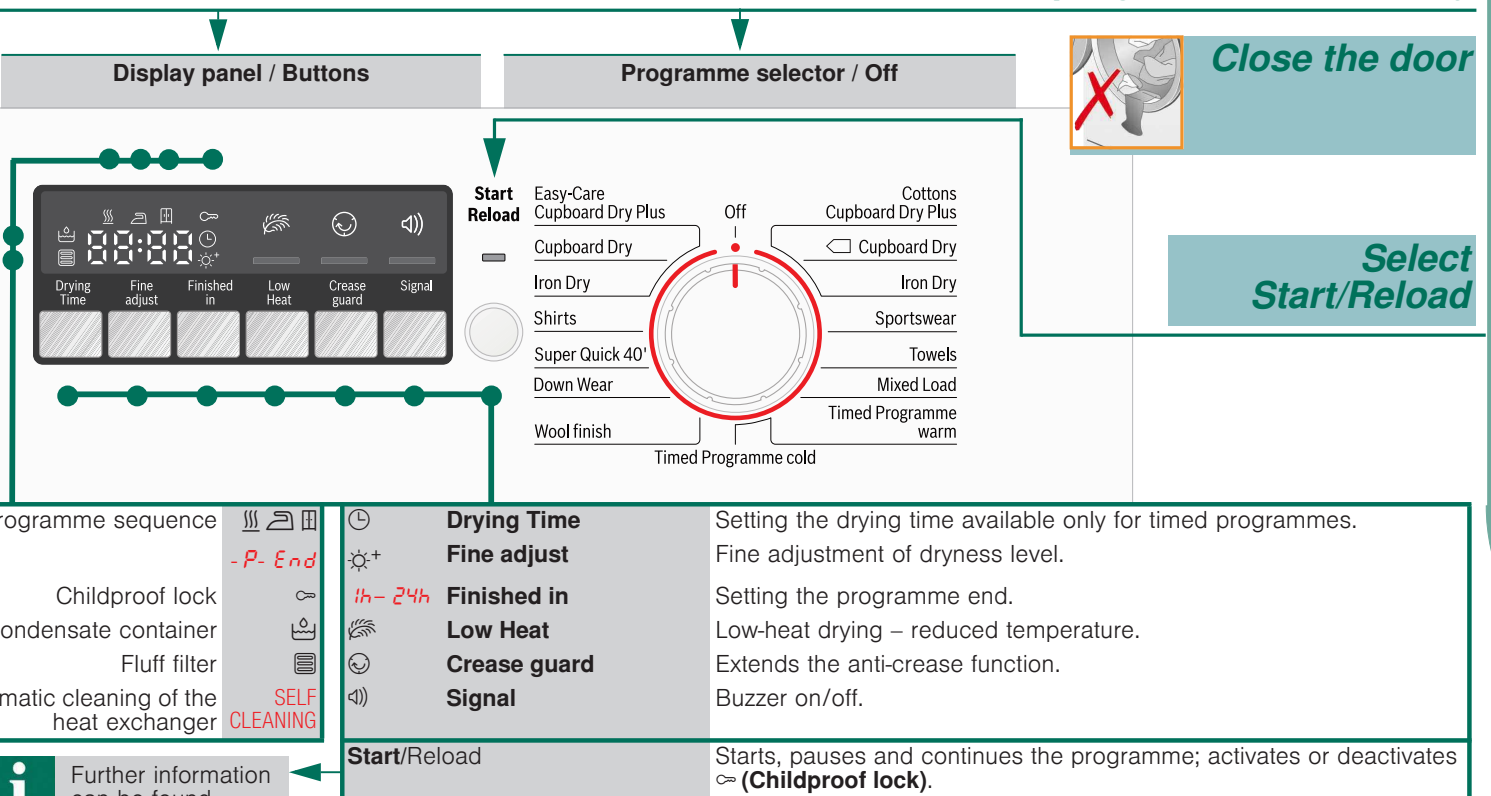

- Further information can be found on page 5
- Start/Reload: Starts, pauses and continues the programme; activates or deactivates (Childproof lock).
- Drying Time: Setting the drying time available only for timed programmes. Fine adjustment of dryness level.
- Fine adjust: Setting the programme end.
- Finished in: Setting the programme end.
- Low Heat: Low-heat drying – reduced temperature.
- Crease guard: Extends the anti-crease function.
- Signal: Buzzer on/off.

# Drying

- Inspect the dryer**
- Connect the mains plug**
- Sort the laundry**
- Close the door**
- Select Start/Reload**
- Remove the laundry and switch off the dryer**
- End of the programme...**

# Empty the condensate container

- Remove the container, holding it level.
  - Pour out the condensate.
  - Always push the container back in until it clicks into place.
- If **(Condensate container)** flashes in the display panel despite the container having been emptied → **clean filter in condensate container, page 8/12.**  
Do not pull out/empty the condensate container when drying is in progress.

# Clean fluff filter

- Clean fluff filters reduce energy consumption.
- The fluff filter consists of two parts. Clean the inner and outer filter **after every** drying cycle:
- Open the door. Remove fluff from the door/door area.
  - Pull out both parts of the fluff filter.
  - Remove fluff from the edge of the shaft. Fluff should not fall into the open shaft.
  - Open the filter and remove all the fluff.
  - Rinse both parts under running water and dry thoroughly.
  - Close the inner and outer filter, put them back together and reinsert them into the appliance.

# Remove the laundry and switch off the dryer

- Interrupt the programme**
- Open the door or press the **Start/Reload** button; the drying cycle is interrupted.
  - Add or remove laundry and close the door.
  - If required, select a new programme and additional functions. Select the **Start/Reload** button. The remaining time is updated after a few minutes.
- The drum and door may be hot!**

# Display panel and settings

- Display panel (status indicators)**
- (Fluff filter)**: Clean the fluff filter → page 4/12.
- (Condensate container)**: Empty the condensate container → page 4,8/12.
- SELF CLEANING**: Automatic cleaning of the heat exchanger → page 8.
- (Programme sequence)**: These indicators show the programme progress in the next steps of the drying cycle:
  - Drying;
  - Iron Dry;
  - Cupboard Dry;
  - P- Programme pause → if required;
  - End Programme end.
- (Childproof lock)**: You can lock the dryer to prevent the functions you have set from being changed inadvertently. To activate/deactivate **(Childproof lock)** start the programme and then press and hold the **Start/Reload** button for 5 seconds until a long acoustic signal is heard. The option activated/deactivated → **(Childproof lock)** indicator light on/off.
- [h:min] (Remaining time)**: When a programme is selected, the anticipated drying time (remaining time) for the recommended load is displayed. While drying, the moisture sensors detect the actual load and correct the programme length. This is shown by jumps in the remaining time in the display panel.
- Settings (Indicators lights and buttons)**
- Drying Time**: Selected option activated/deactivated → indicator light on/off. See the separate **Energy-saving mode** instructions. Drying time, available only for timed programmes, can be selected from min. 0:20 h to max. 3:00 h, in 10-minute steps.
- Fine adjust**: The dryness levels (e.g. Cupboard Dry) can be increased in three levels. The laundry is made drier. Default = 0. Selectable values: 0, 1, 2, 3. After setting the level of the fine adjustment for a programme, it is also retained for other programmes, until **Fine adjust** is changed again.
- h - 24h Finished in**: The time when the programme has to end can be set by selecting the **Finished in** time. The **Finished in** time can be selected in one-hour steps, up to a maximum of 24 hours. Select the **Finished in** button repeatedly until the required number of hours is displayed. Then press the **Start/Reload** button to activate the **Finished in** option. The programme ends after the selected number of hours. Several minutes after activating **Finished in** option the display switches off to save energy. To switch it on select any button, close/open the door or turn the programme selector.
- Low Heat**: Reduced temperature for delicate fabrics, e.g. polyacrylic, polyamide or elastane, with a longer drying time.
- Crease guard**: After the programme finishes, the drum moves at regular intervals to prevent creases. Laundry remains loose and fluffy. The standard setting for each programme is 60 min. Automatic anti-crease function can be extended by up to 60 min.
- Signal**: For switching the buzzer on and off. **Signal** indicates program end if it is activated. Other sounds are not influenced by this option.

# Notes on laundry ...

- Labelling of fabrics**
- Follow the manufacturer's care instructions.**
  - Suitable for tumble drying.
  - Dry at normal temperature.
  - Dry at low temperature → in addition, select **Low Heat**.
  - Do not tumble dry.
- Drying tips**
  - To ensure a consistent drying result, sort the laundry by fabric type and drying programme.
  - Always dry very small fabrics (e.g. baby socks) together with large items of laundry (e.g. towels).
  - Close zips, hooks and eyelets, and button up covers.
  - Tie cloth belts, apron strings, etc. together or use a laundry bag.
  - Do not over-dry easy-care laundry → risk of creasing.
  - Allow laundry to finish drying in the air.
  - Do not dry woollens in the dryer. They may, however, be refreshed in the dryer → page 7, **Wool finish** Programme (depending on model).
  - Do not iron laundry immediately after drying; fold items up and leave for a while → residual moisture will then be distributed evenly.
  - Knitted fabrics (e.g. T-shirts, jerseys) often shrink slightly the first time they are tumble-dried. → Do not use the **Cupboard Dry Plus** programme.
  - Starched laundry is not always suitable for dryers → starch leaves behind a coating that reduces the drying effect.
  - When washing laundry that is to be tumble dried afterwards, use the correct amount of fabric softener as specified in the manufacturer's instructions.
  - For pre-dried, multi-layered fabrics or small, individual items of laundry, use the timed programme. Also suitable for subsequent drying.
- Environmental protection / Energy-saving tips**
  - Before drying, spin the laundry in the washing machine → higher spin speeds minimise the drying time and reduce energy consumption.
  - Use the maximum recommended capacity, but do not exceed it → Programme overview page 7.
  - Make sure the room is well ventilated during drying.
  - Do not cover or seal the air inlet on the dryer.

# Important information ...

- Your dryer is designed to be particularly energy efficient. Its technical features include a refrigeration circuit, which uses energy efficiently in a similar way to a refrigerator. The dryer's heat exchanger is cleaned automatically during drying. The fluff filters and filter in the condensate container must be cleaned regularly.
- Never operate the dryer without the fluff filters and without filter in condensate container!**
- Fluff filters**: During drying, fluff and hair from the laundry is trapped by the fluff filter. Blocked fluff filters may impair the heat exchange process. The fluff filters must therefore be cleaned after every drying cycle. Rinse regularly under running water → page 4/12.
- Filter in the condensate container**: The filter in the condensate container cleans the condensation. This condensation is required for the automatic cleaning process. The filter should be cleaned regularly under running water. Empty the condensate container before cleaning the filter → page 4,8/12.
- Fabrics**: Do not dry any fabrics that have come into contact with solvents, oil, wax, grease or paint: e.g. hair styling products, nail varnish remover, stain remover, cleaning solvent etc. Do not dry non-breathable fabrics. Avoid drying items that produce a lot of fluff. Woollens should be refreshed only, using the woollens programme.

<b>Programme overview</b> see also page 6.	
Sort the laundry according to type of textile and fabric. Fabrics must be suitable for tumble drying.	
After drying, laundry is to be ...	
<b>PROGRAMMES</b>	<b>TEXTILE TYPE AND INFORMATION</b>
*Cottons	Hard-wearing fabrics, boilerproof fabrics made of cotton or linen.
*Easy-Care	Non-iron laundry made of synthetic fibres and mixed fabric, easy-care cotton.
Iron Dry	The condition of the laundry means it is suitable for ironing (iron clothes in order to avoid creases).
Cupboard Dry	Single-layered laundry.
Cupboard Dry Plus	Laundry with thick, multi-layered parts.
Sportswear	Fabrics with membrane coating, water-repellent fabrics, functional clothing, fleece fabrics (dry jackets/trousers with removable internal lining separately).
Towels	Terry-towelling laundry e.g. towels and bathrobes.
Mixed Load	Mixed items of laundry made of cotton and synthetics (Mix).
Timed Programme warm	Suitable for pre-dried or slightly damp laundry and for drying off multi-layered, thick laundry.
Timed Programme cold	Only dry wool, sports shoes and soft toys with the basket for woollens → Optional Accessories, page 10. In the time programme, the laundry's residual moisture is not automatically detected. If the laundry is still too damp after the drying programme, repeat the programme and, if required, extend the programme length.
Shirts	All types of fabrics. For freshening up or airing of items of laundry that have been worn for a short period of time. Cotton or linen fabrics that are still damp and easy-care fabrics. Creasing in fabrics is reduced. Fabrics are not dried completely. Hang up fabrics.
Super Quick 40'	Laundry made of synthetic fibres, cotton or blended fabrics (for example) that needs to be dried quickly. The values may differ from those specified depending on the type of fabric, mixture of laundry to be dried, residual moisture in the fabric and loading capacity.
Down Wear	Garments with down feather fillings, pillows and blankets. By non quilt loads - please add just 1 piece per drying.
Wool finish	Woollen fabrics suitable for washers. Fabrics become fluffier but not dry. Remove fabrics once the programme has ended and allow to dry.

\*Dryness levels can be selected individually → Cupboard Dry Plus, Cupboard Dry and Iron Dry (depending on the model). Degree of dryness can be finely adjusted; multi-layered textiles require a longer drying time than single-layered items of clothing. Recommendation: Dry separately.



## Care and cleaning

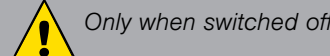

### Heat exchanger

The dryer's heat exchanger is cleaned automatically during drying. **SELF CLEANING** appears rolling in the display panel. Do not pull out the condensate container during the cleaning process.

### Dryer housing, control panel

- Wipe with a soft, damp cloth.
- Do not clean with a water jet.
- Remove detergent and cleaning agent residue immediately.
- Some water may collect between the window and the seal during drying.
- This does not affect the proper operation of your dryer in any way.

### Filter in the condensate container

The filter is cleaned automatically when the condensate container is emptied. However, the filter should still be cleaned regularly under running water → This prevents stubborn deposits/dirt from building up.

1. Pull out the condensate container.

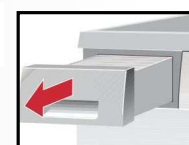

2. Pull the filter out of its snap-in lock.

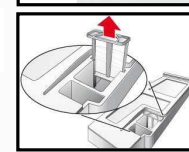

3. Clean the filter under running water or in the dishwasher.

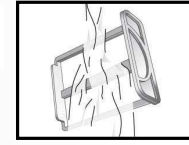

4. Refit the filter.
5. Insert the condensate container so that it locks into place.

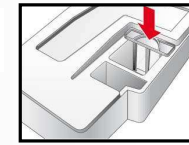

**Only operate the dryer with the filter inserted.**

### Moisture sensors

The dryer is equipped with stainless steel moisture sensors. Moisture sensors measure the moisture level of the laundry. After sustained, repeated operation, a fine layer of limescale may form on the moisture sensors.



1. Open the door.
2. Clean the moisture sensors with a damp sponge which has a rough surface.

**Do not use steel wool or abrasive agents!**

## Installation

- Scope of delivery: dryer, operating and installation instructions, basket for woollens (*depending on the model*).
- Check the dryer for transport damage.
- The dryer is very heavy. Do not attempt to lift it on your own.
- Be careful to avoid sharp edges.
- Do not lift the dryer by protruding parts (e.g. the door) - risk of breakage.
- Do not set up in a room that is susceptible to frost.
- Freezing water may cause damage.
- If in doubt, have the appliance connected by a specialist.

### 1. Setting up the dryer

- The mains plug must always be accessible.
- Ensure that the appliance is placed on a clean, level and firm surface.
- Do not obstruct the air inlet on the dryer.
- Keep the area around the dryer clean.
- Level the dryer using the threaded feet and a spirit level.
- Never remove the threaded feet!

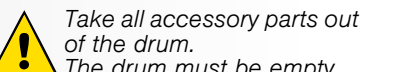

**Do not install the dryer behind a door or sliding door which could prevent or obstruct the dryer door from opening. This will prevent children from locking themselves in and risking their lives.**

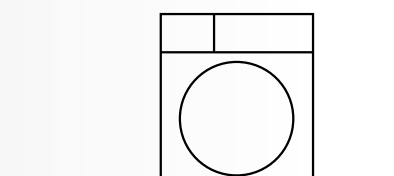

**Clean and level**  
Make sure that the air inlet remains unobstructed

### 2. For mains connection, see Safety instructions → page 13.

- Connect to an AC earthed socket. If in doubt have the socket checked by a specialist.
- The mains voltage and the voltage shown on the rating plate (→ page 10) must be the same.
- The connected load and necessary fuse protection are specified on the rating plate.

## Frost protection

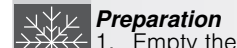

- **Preparation**
  1. Empty the condensate container → page 4,8/12.
  2. Select any programme using the programme selector.
  3. Press the **Start/Reload** button → condensation is pumped into the container.
  4. Wait several minutes or until the dryer stops, and then empty the condensate container again.
  5. Turn the programme selector to **Off**.

## Transport

- Prepare the dryer → see *Frost protection*.
- Transport the dryer in a vertical upright position.
- Following transportation, do not use the dryer for two hours.



The dryer contains residual water; this can flow out if the dryer is tilted.

## Technical Data

- **Dimensions (DxWxH)** 60 x 60 x 85 cm (height adjustable)
- **Weight** approx. 51 kg
- **Max. capacity** 8 kg
- **Condensate container** 4.0 l
- **Connection voltage** 220-240 V
- **Connected load** 1000 W
- **Fuse protection** 10 A
- **Ambient temperature** 5 - 35°C
- **Product number Production number** Inside of door  
The rating plate can be found on the back of the dryer.
- **Power consumption when switched off** 0.10 W
- **Power consumption when ready for use (left-on mode)** 1.00 W
- **Drum interior light (depending on model):** The drum lights up after the door is opened and after the programme starts, and switches off automatically.

## Consumption values table

Programme	Spin speed which is used for spinning the laundry	Duration**		Energy consumption**	
		8 kg	4 kg	8 kg	4 kg
Cottons Cupboard Dry*	1400 rpm	179 min	111 min	1.57 kWh	0.93 kWh
	1000 rpm	203 min	122 min	1.80 kWh	1.04 kWh
	800 rpm	227 min	143 min	2.04 kWh	1.25 kWh
Iron Dry*	1400 rpm	125 min	75 min	1.10 kWh	0.66 kWh
	1000 rpm	150 min	90 min	1.36 kWh	0.82 kWh
	800 rpm	176 min	106 min	1.64 kWh	0.98 kWh
Easy-Care Cupboard Dry*	800 rpm	55 min	55 min	0.51 kWh	0.51 kWh
	600 rpm	71 min	71 min	0.66 kWh	0.66 kWh

\* Programme setting for testing in accordance with the applicable EN61121 standard.  
\*\* The values may differ from those specified, depending on the type of fabric, composition of laundry to be dried, residual moisture in the fabric, the degree of dryness that has been set, the amount of laundry being loaded and the environmental conditions.

## Most efficient programme for cotton fabrics

The following "standard cottons programme" (identified with ) is suitable for drying normal, wet cotton laundry and is most efficient in terms of its combined energy consumption for drying wet cotton laundry.

### Standard programme for cottons in accordance with current EU regulation 932/2012

Programme	Load	Energy consumption	Programme duration
Cottons Cupboard Dry	8 kg/4 kg	1.80 kWh/1.04 kWh	203 min/122 min

Programme setting for testing and energy labelling in accordance with Directive 2010/30/EU.

## Optional accessories (order from the after-sales service using the order number, depending on the model)

- **WTZ 20410 Washer-dryer stack connection set**  
The dryer can be placed on top of a suitable washing machine with the same width and depth to save space. The dryer **must be** fastened to the washing machine using this connection set.  
WTZ 11400: with pull-out worktop.
- **WMZ 20500 Platform**  
For easier loading and unloading. The basket contained in the drawer can be used to carry the laundry.
- **WMZ 20600 Woollens basket**  
For drying **individual** wollen fabrics, sports shoes and soft toys (see separate instructions for "Woollens basket").

## Normal noises

During drying, the compressor and the pump generate some noise which is entirely normal.

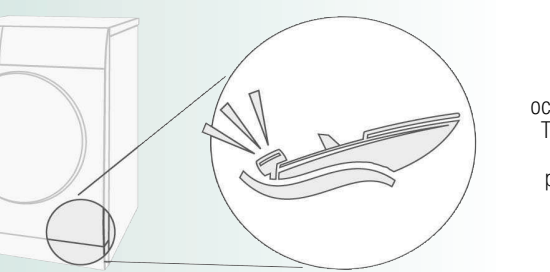

The compressor in the dryer may occasionally generate a humming noise. The volume and pitch of this may vary depending on the selected programmes and the progress of the drying.

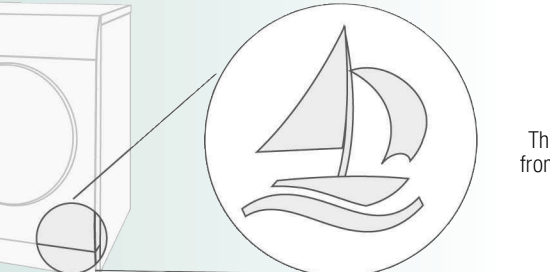

The compressor in the dryer is ventilated from time to time, which creates a whirring sound.

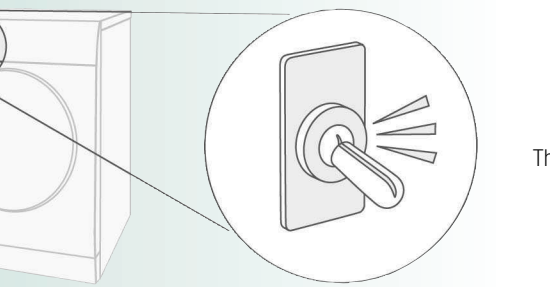

The automatic cleaning process causes a clicking noise.

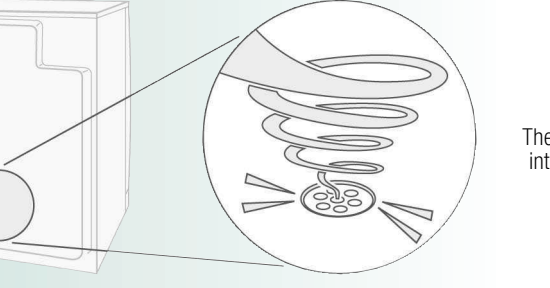

The process of pumping the condensation into the condensate container generates pumping noises.

## What to do if ...

- The **Start/Reload** indicator light does not light up. Mains plug plugged in? Programme selected? Check the socket fuse.
- The display panel light and indicator lights (*depending on model*) go out and the **Start/Reload** indicator light flashes. Energy-saving mode is activated → see the separate *Energy-saving mode* instructions.
- The display panel switches off. The appliance goes into the sleep mode after activating **Finished in option** → page 5.
- The (**Condensate container**) indicator light flashes. Empty the condensate container → page 4. Press the **Start/Reload** button to reset the displayed indication and then press the **Start/Reload** button again to restart the appliance if necessary.
- (**Fluff filter**) indicator light flashes. Clean the fluff filter → page 4/8. Press the **Start/Reload** button to reset the displayed indication and then press the **Start/Reload** button again to restart the appliance if necessary.
- **SELF CLEANING** appears in the display panel. Not an error. Automatic cleaning of the heat exchanger. Do not empty the condensate container.
- Dryer does not start. **Start/Reload** button selected? Door closed? Ambient temperature greater than 5°C? The optimum ambient temperature for drying is between 5 °C and 35 °C.
- Programme terminates shortly after starting. Is the appliance loaded with the laundry? Load too small for selected programme?/Use timed programme → page 6/7. Loaded laundry dry?
- Water is leaking out. Make sure the dryer is level.
- The door opens by itself. Push the door closed until you hear it engage.
- Creasing. Laundry load exceeded? Remove articles of clothing immediately after the end of the programme, hang up and pull into shape. Unsuitable programme selected → page 7.
- Laundry is not dried correctly or is still too damp. After the end of the programme, warm laundry feels damper than it actually is. Spread the laundry out and allow the heat to disperse. Finely adjust the dryness level – this extends the drying time but does not increase the temperature. Your laundry will become drier. Select a programme with a longer drying time or increase the drying level. This does not increase the temperature. Select a time programme for extended drying of laundry that is still damp. If you have exceeded the maximum load for the programme, the laundry may not be dried correctly. Clean the moisture sensor in the drum. A fine layer of limescale may adversely affect the performance of the sensors and your washing will not dry properly. Drying has been interrupted as a result of a power cut, because the condensate container is full or because the maximum drying time has been exceeded. Clean the fluff filters under running water → page 4/8. Insufficient supply of air → Ensure that air can circulate. Air inlet possibly blocked → Clear inlet → page 9. Ambient temperature higher than 35°C → Ventilate the room. The optimum ambient temperature for drying is between 5 °C and 35 °C. Outside of this range, the drying time may increase.
- One or more indicator lights are flashing. Clean the fluff filter → page 4,8/12. Check the installation conditions → page 9. Switch off, allow to cool, switch back on and restart the programme.
- Power failure. Remove the laundry from the dryer immediately and spread out. This allows the heat to dissipate. Be careful as the door, the drum and the laundry may be hot.
- Other intermittent noises and vibrations. Not an error. Normal noises → page 11.
- Loud humming noise for several seconds. Has the condensate container been properly inserted? → Push the condensate container all the way in. Not an error. Normal noises → page 11.

## After-sales service

If you cannot rectify the fault yourself (e.g. switching off/on) → *What to do if...* page 12, please contact our after-sales service. We will always find an appropriate solution and avoid unnecessary visits by engineers.

The contact details of your local **after-sales service** can be found in the enclosed after-sales service directory. Please provide the after-sales service the product number (E no.) and the production number (FD) of the appliance.  
– **GB** 03 448 928 979 (Calls charged at local or mobile rate.)  
– **IE** 01450 2655 (0.03 € per minute at peak. Off peak 0.0088 € per minute.)

E-Number: \_\_\_\_\_ FD: \_\_\_\_\_  
Product number: \_\_\_\_\_ Production number: \_\_\_\_\_

Trust the expertise of the manufacturer. Contact us for assistance. In this way, you can rest assured that the repair will be carried out by trained service technicians using original spare parts.

## Safety instructions

- **Emergency ONLY use the dryer...**
  - Pull the appliance plug out of the socket immediately or disconnect the fuse.
  - in rooms inside the house.
  - to dry fabrics.
- **The dryer must NEVER...**
  - be used for purposes other than those described above.
  - be modified in terms of its technology or properties.
- **Hazards**
  - The dryer must not be used by children or persons who have not been instructed in its use.
  - Do not leave children unsupervised near the dryer.
  - Keep pets away from the dryer.
  - Remove all objects from pockets, and lighters in particular → **Risk of explosion**.
  - Do not lean or sit on the door → **Risk of tipping**.
- **Installation**
  - Secure loose cables → **Risk of tripping**.
  - Do not operate a dryer if there is a risk of frost.
- **Mains connection**
  - Connect the dryer to an AC earthed socket according to specifications, otherwise it cannot be guaranteed that the appliance is completely safe.
  - The cable cross-section must be sufficient.
- **Operation**
  - Only use earth-leakage circuit breakers with the following symbol:
  - The appliance plug and socket must be compatible.
  - Do not use multiple plugs/connectors and/or extension cables.
  - Do not touch or hold the appliance plug with wet hands → **Risk of electric shock**.
  - Never pull the appliance plug out of the socket by its cable.
  - Do not damage the mains lead → **Risk of electric shock**.
- **Defect**
  - Only load the drum with laundry. Check the contents before you switch the dryer on.
  - Do not use the dryer if the laundry has been in contact with solvents, oil, wax, grease or paint (e.g. hair styling products, nail varnish remover, stain remover, cleaning solvent, etc.) → **Risk of fire/explosion**.
  - The tumble dryer is not to be used if industrial chemicals have been used for cleaning.
  - Dust (e.g. coal dust, flour) poses a danger: Do not use the dryer → **Risk of explosion**.
  - Do not turn off the dryer until the drying process ends, unless the laundry will be removed quickly and spread out, so that the heat can dissipate.
  - Do not put laundry containing foamed material/rubber in the dryer → elastic material may be destroyed and the dryer be damaged due to possible deformation of the foamed material.
  - When cleaning the fluff filter, make sure that no foreign material (down or filling material) gets into the air duct opening. If necessary, clean the drum beforehand with a vacuum cleaner. If foreign material should still get into the air duct → call the after-sales service → **Risk of fire/explosion**.
  - Light things, such as long hair, may be sucked into the air inlet of the dryer → **Risk of injury**.
  - Final part of a tumble dryer cycle occurs without heat (cool down cycle), to ensure that the items are left at a temperature that ensures that the items will not be damaged.
  - Switch off the dryer once the programme has ended.
  - The water from condensation is not drinking water and may be contaminated with fluff.
- **Spare parts**
  - For safety reasons, you must only use genuine spare parts and accessories.
- **Disposal**
  - Pull out the appliance plug, **then** cut off the mains cable from the appliance.
  - Dispose of the appliance at a municipal waste disposal facility.
  - Heat exchangers contain a fluorinated greenhouse gas (R134a) in hermetically sealed equipment → dispose of in a proper manner. Capacity: 0.220 kg. Total GWP: 0.315 tCO<sub>2</sub>.
  - Packaging: Keep all packaging out of reach of babies and children → **Risk of suffocation**.
  - All materials are environmentally sound and can be reused.
  - Dispose of them in an environmentally-responsible manner.

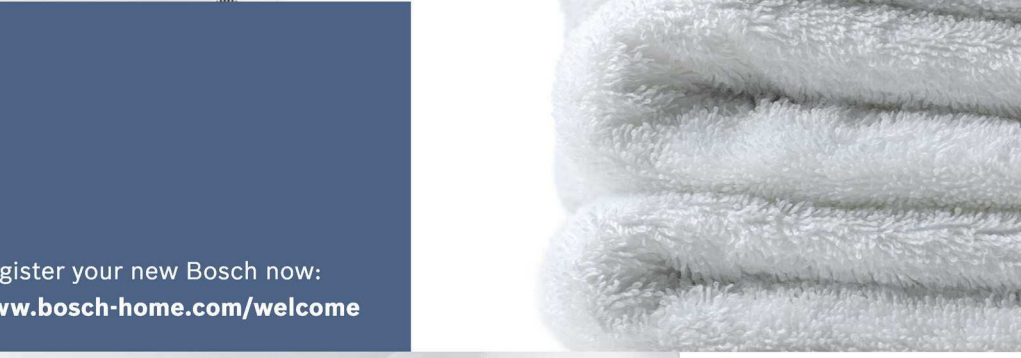

Register your new Bosch now:  
[www.bosch-home.com/welcome](http://www.bosch-home.com/welcome)

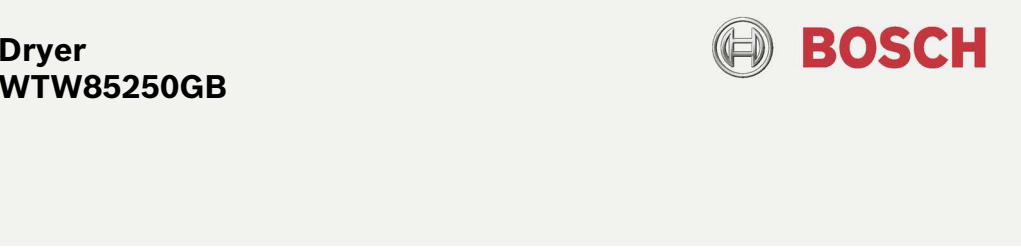



# Your new dryer

**Congratulations** - You have chosen a modern, high-quality Bosch domestic appliance.

The condensation dryer with heat pump and automatic cleaning of the heat exchanger is outstanding in terms of efficient energy consumption and low maintenance requirements → page 6. Every dryer which leaves our factory is carefully checked to ensure that it functions correctly and is in perfect condition. Should you have any questions, our after-sales service will be pleased to help.

## Disposal in an environmentally-responsible manner

This appliance is labelled in accordance with European Directive 2012/19/EU concerning used electrical and electronic appliances (waste electrical and electronic equipment - WEEE). The guideline determines the framework for the return and recycling of used appliances as applicable throughout the EU.

For further information about our products, accessories, spare parts and services, please visit: [www.bosch-home.com](http://www.bosch-home.com)



Observe the safety instructions on page 13.



Read these instructions and the separate **Energy-saving mode** instructions before operating the dryer.

## Contents

Page

■ Preparation	2
■ Control panel	2
■ Drying	3/4
■ Display panel and settings	5
■ Notes on laundry	6
■ Important information	6
■ Overview of programmes	7
■ Care and cleaning	8
■ Installation	9
■ Frost protection / Transport	9
■ Optional accessories	10
■ Technical data	10
■ Consumption rates	10
■ Normal noises	11
■ What to do if ...	12
■ After-sales service	13
■ Safety instructions	13

## Intended use

- exclusively for domestic use,
- only for drying fabrics which have been washed using water.



Keep children younger than 3 years old away from the dryer.  
Do not let children make the cleaning and maintenance work on the dryer without supervision. Do not leave children unsupervised near the dryer. Keep pets away from the dryer.  
The dryer may be operated by children from 8 years of age, by persons who have limited physical, sensory or mental abilities and by persons who have inadequate experience or knowledge, provided they are supervised or have been instructed by a responsible person.  
This appliance is intended for use up to a maximum height of 4000 metres above sea level.

## Programmes / Fabrics

Detailed overview of the programmes and fabrics → Programme overview, page 7.  
Observe the care instructions on the care label.

<b>Cottons</b>	Hard-wearing fabrics.
<b>Easy-Care</b>	Fabrics made from synthetic or blended fabrics.
<b>Dryness levels to select with the Cottons and Easy-Care programmes:</b>	
<b>Cupboard Dry Plus</b>	Thick and multi-layered fabrics.
<b>Cupboard Dry</b>	Single-layered laundry.
<b>Iron Dry</b>	Laundry suitable for ironing after drying.
<b>Sportswear</b>	Functional clothing made of microfibre.
<b>Towels</b>	Terry-towelling laundry e.g. towels and bathrobes.
<b>Mixed Load</b>	A mixed load of fabrics made of cotton and synthetic fabrics.
<b>Timed Programme warm</b>	} All types of fabric; time programme.
<b>Timed Programme cold</b>	
<b>Shirts</b>	Cotton or linen fabrics that are still damp and easy-care fabrics.
<b>Super Quick 40'</b>	Synthetics, cotton or blended fabrics.
<b>Down Wear</b>	Fabrics with down filling.
<b>Wool finish</b>	Woollen fabrics that are suitable for use in washers.

## Preparation

Installation → page 9.



Never start the dryer without reading the instructions.

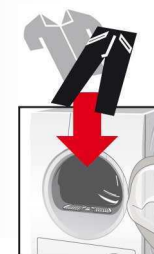

Programme selection: Press the programme button to select the programme on/off. Can be used for all programmes.

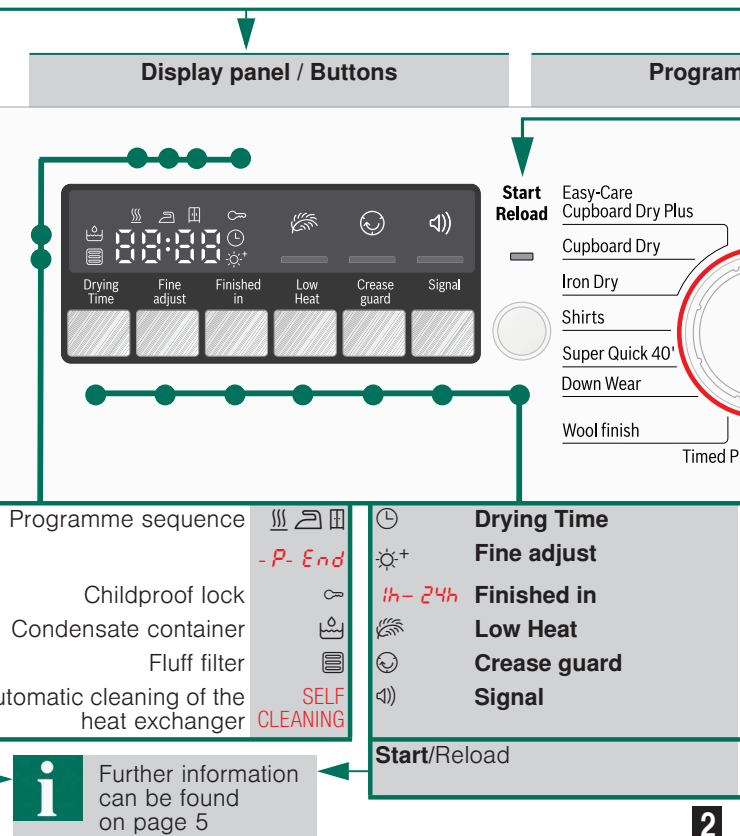

Check the dryer if it is damaged!  
Contact your after-sales service!

### Inspect the dryer

Make sure your hands are dry.  
Only grasp the plug by the plug  
body.

### Connect the mains plug

### Sort the laundry

Remove all items from pockets,  
especially cigarette lighters.  
The drum must be empty prior to loading.

See also separate instructions for "Woollens basket"  
(depending on model).

Selector for setting  
and switching the appliance  
turned in both directions.

### Set and adjust the programme individually

Programme selector / Off

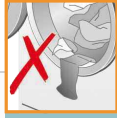

### Close the door

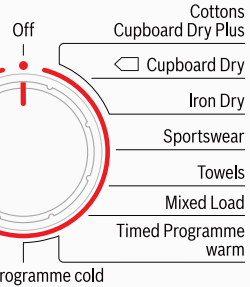

### Select Start/Reload

Setting the drying time available only for timed programmes.

Fine adjustment of dryness level.

Setting the programme end.

Low-heat drying – reduced temperature.

Extends the anti-crease function.

Buzzer on/off.

Starts, pauses and continues the programme; activates or deactivates  
the **(Childproof lock)**.

# Drying

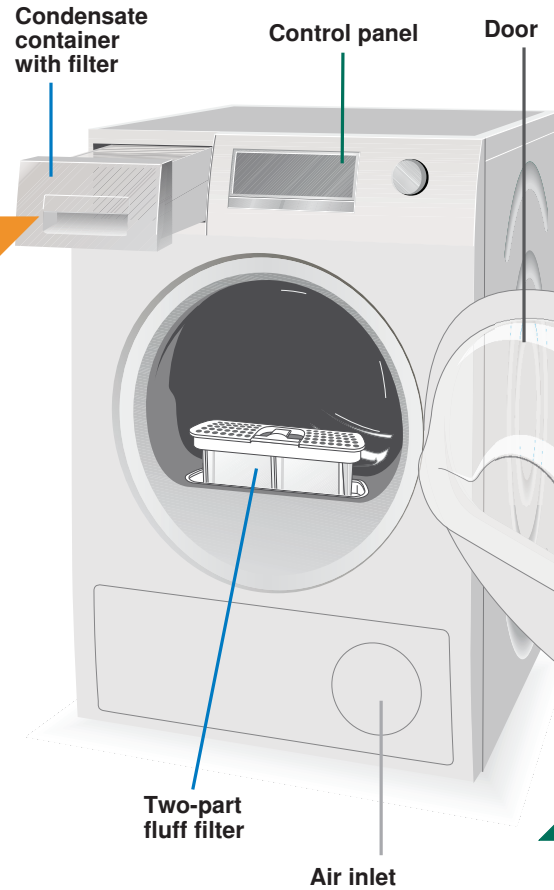

1

2

3



7



6

5

4

## Empty the condensate container

Empty the container **after each** drying cycle,  
but not during the cycle.

1. Remove the container, holding it level.
2. Pour out the condensate.
3. Always push the container back in until it clicks into place.



If the **(Condensate container)** flashes in the display panel despite the container having been emptied → *clean filter in condensate container, page 8/12.*

**!** Do not pull out/empty the condensate container when drying is in progress.

## Clean fluff filter

**i** Clean fluff filters reduce energy consumption.

The fluff filter consists of two parts. Clean the inner and outer filter **after every** drying cycle:

1. Open the door. Remove fluff from the door/door area.
2. Pull out both parts of the fluff filter.
3. Remove fluff from the edge of the shaft. Fluff should not fall into the open shaft.
4. Open the filter and remove all the fluff.
5. Rinse both parts under running water and dry thoroughly.
6. Close the inner and outer filter, put them back together and reinsert them into the appliance.

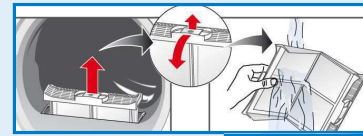

## Remove the laundry and switch off the dryer

### End of the programme...

#### Interrupt the programme

1. Open the door or press the **Start/Reload** button; the drying cycle is interrupted.
2. Add or remove laundry and close the door.
3. If required, select a new programme and additional functions. Select the **Start/Reload** button. The remaining time is updated after a few minutes.

**!** The drum and door may be hot!

# Drying

3

4

# Display panel and settings

## Display panel (status indicators)



**(Fluff filter)** Clean the fluff filter → page 4/12.



**(Condensate container)** Empty the condensate container → page 4,8/12.

**SELF CLEANING** Automatic cleaning of the heat exchanger → page 8.

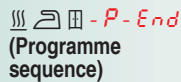

These indicators show the programme progress in the next steps of the drying cycle:

- ☰ Drying;
- ☰ Iron Dry;
- ☰ Cupboard Dry;
- P- Programme pause → if required;
- End Programme end.



**(Childproof lock)** You can lock the dryer to prevent the functions you have set from being changed inadvertently. To activate/deactivate **(Childproof lock)** start the programme and then press and hold the **Start/Reload** button for 5 seconds until a long acoustic signal is heard. The option activated/deactivated → **(Childproof lock)** indicator light on/off.



**(Remaining time)** When a programme is selected, the anticipated drying time (remaining time) for the recommended load is displayed. While drying, the moisture sensors detect the actual load and correct the programme length. This is shown by jumps in the remaining time in the display panel.

## Settings (indicators lights and buttons)



Selected option activated/deactivated → indicator light on/off. See the separate **Energy-saving mode** instructions.



**Drying Time** Drying time, available only for timed programmes, can be selected from min. 0:20 h to max. 3:00 h, in 10-minute steps.



**Fine adjust** The dryness levels (e.g. Cupboard Dry) can be increased in three levels. The laundry is made drier. Default = 0. Selectable values: 0, 1, 2, 3. After setting the level of the fine adjustment for a programme, it is also retained for other programmes, until **Fine adjust** is changed again.

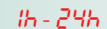

**Finished in** The time when the programme has to end can be set by selecting the **Finished in** time. The **Finished in** time can be selected in one-hour steps, up to a maximum of 24 hours. Select the **Finished in** button repeatedly until the required number of hours is displayed. Then press the **Start/Reload** button to activate the **Finished in** option. The programme ends after the selected number of hours.

Several minutes after activating **Finished in** option the display switches off to save energy. To switch it on select any button, close/open the door or turn the programme selector.



**Low Heat** Reduced temperature for delicate fabrics, e.g. polyacrylic, polyamide or elastane, with a longer drying time.



**Crease guard** After the programme finishes, the drum moves at regular intervals to prevent creases. Laundry remains loose and fluffy. The standard setting for each programme is 60 min. Automatic anti-crease function can be extended by up to 60 min.



**Signal** For switching the buzzer on and off. **Signal** indicates program end if it is activated. Other sounds are not influenced by this option.

# Notes on laundry ...



## Labelling of fabrics

### Follow the manufacturer's care instructions.

- Suitable for tumble drying.
- Dry at normal temperature.
- Dry at low temperature → in addition, select **Low Heat**.
- Do not tumble dry.



Do not tumble dry the following fabrics:

- Non-breathable fabrics (e.g. rubber-coated).
- Delicate materials (silk, curtains made from synthetic material) → these may crease.
- Oil-stained laundry.



## Drying tips

- To ensure a consistent drying result, sort the laundry by fabric type and drying programme.
- Always dry very small fabrics (e.g. baby socks) together with large items of laundry (e.g. towels).
- Close zips, hooks and eyelets, and button up covers. Tie cloth belts, apron strings, etc. together or use a laundry bag.
- Do not over-dry easy-care laundry → risk of creasing. Allow laundry to finish drying in the air.
- Do not dry woollens in the dryer. They may, however, be refreshed in the dryer → page 7, **Wool finish Programme** (depending on model).
- Do not iron laundry immediately after drying; fold items up and leave for a while → residual moisture will then be distributed evenly.
- Knitted fabrics (e.g. T-shirts, jerseys) often shrink slightly the first time they are tumble-dried. → Do not use the **Cupboard Dry Plus** programme.
- Starched laundry is not always suitable for dryers → starch leaves behind a coating that reduces the drying effect.
- When washing laundry that is to be tumble dried afterwards, use the correct amount of fabric softener as specified in the manufacturer's instructions.
- For pre-dried, multi-layered fabrics or small, individual items of laundry, use the timed programme. Also suitable for subsequent drying.

## Environmental protection / Energy-saving tips

- Before drying, spin the laundry in the washing machine → higher spin speeds minimise the drying time and reduce energy consumption.
- Use the maximum recommended capacity, but do not exceed it → *Programme overview page 7*.
- Make sure the room is well ventilated during drying.
- Do not cover or seal the air inlet on the dryer.

# Important information ...



Your dryer is designed to be particularly energy efficient. Its technical features include a refrigeration circuit, which uses energy efficiently in a similar way to a refrigerator. The dryer's heat exchanger is cleaned automatically during drying. The fluff filters and filter in the condensate container must be cleaned regularly.

*Never operate the dryer without the fluff filters and without filter in condensate container!*

## Fluff filters

During drying, fluff and hair from the laundry is trapped by the fluff filter. Blocked fluff filters may impair the heat exchange process.

The fluff filters must therefore be cleaned after every drying cycle. Rinse regularly under running water → page 4/12.

## Filter in the condensate container

The filter in the condensate container cleans the condensation. This condensation is required for the automatic cleaning process. The filter should be cleaned regularly under running water. Empty the condensate container before cleaning the filter → page 4,8/12.

## Fabrics

Do not dry any fabrics that have come into contact with solvents, oil, wax, grease or paint: e.g. hair styling products, nail varnish remover, stain remover, cleaning solvent etc.

Empty all pockets.

Do not dry non-breathable fabrics.

Avoid drying items that produce a lot of fluff.

Woollens should be refreshed only, using the woollens programme.

# Programme overview

see also page 6.

Sort the laundry according to type of textile and fabric. Fabrics must be suitable for tumble drying.

After drying, laundry is to be ...



lightly ironed



## PROGRAMMES

### TEXTILE TYPE AND INFORMATION

<b>*Cottons</b>	max. 8 kg	Hard-wearing fabrics, boil-proof fabrics made of cotton or linen.
<b>*Easy-Care</b>	max. 3.5 kg	Non-iron laundry made of synthetic fibres and mixed fabric, easy-care cotton.
Iron Dry		The condition of the laundry means it is suitable for ironing (iron clothes in order to avoid creases).
Cupboard Dry		Single-layered laundry.
Cupboard Dry Plus		Laundry with thick, multi-layered parts.
<b>Sportswear</b>	max. 1.5 kg	Fabrics with membrane coating, water-repellent fabrics, functional clothing, fleece fabrics (dry jackets/trousers with removable internal lining separately).
<b>Towels</b>	max. 6 kg	Terry-towelling laundry e.g. towels and bathrobes.
<b>Mixed Load</b>	max. 3 kg	Mixed items of laundry made of cotton and synthetics (Mix).
<b>Timed Programme warm</b>	max. 3 kg	Suitable for pre-dried or slightly damp laundry and for drying off multi-layered, thick laundry. Only dry wool, sports shoes and soft toys with the basket for woollens → <i>Optional Accessories, page 10</i> . In the time programme, the laundry's residual moisture is not automatically detected. If the laundry is still too damp after the drying programme, repeat the programme and, if required, extend the programme length.
<b>Timed Programme cold</b>	max. 3 kg	All types of fabrics. For freshening up or airing of items of laundry that have been worn for a short period of time.
<b>Shirts</b>	max. 1.5 kg	Cotton or linen fabrics that are still damp and easy-care fabrics. Creasing in fabrics is reduced. Fabrics are not dried completely. Hang up fabrics!
<b>Super Quick 40'</b>	max. 1 kg	Laundry made of synthetic fibres, cotton or blended fabrics (for example) that needs to be dried quickly. The values may differ from the those specified depending on the type of fabric, mixture of laundry to be dried, residual moisture in the fabric and loading capacity.
<b>Down Wear</b>	max. 1.5 kg	Garments with down feather fillings, pillows and blankets. By non quilt loads - please add just 1 piece per drying.
<b>Wool finish</b>	max. 3 kg	Woolen fabrics suitable for washers. Fabrics become fluffier but not dry. Remove fabrics once the programme has ended and allow to dry.

\*Dryness levels can be selected individually → Cupboard Dry Plus, Cupboard Dry and Iron Dry (*depending on the model*).

Degree of dryness can be finely adjusted; multi-layered textiles require a longer drying time than single-layered items of clothing.  
Recommendation: Dry separately.

9604 / 9001069277



Robert Bosch Hausgeräte GmbH  
Carl-Wery-Str. 34  
81739 München/Deutschland

WTW85250GB



## Care and cleaning



Only when switched off!



### Heat exchanger

The dryer's heat exchanger is cleaned automatically during drying. **SELF CLEANING** appears rolling in the display panel. Do not pull out the condensate container during the cleaning process.

### Dryer housing, control panel

- Wipe with a soft, damp cloth.
- Do not clean with a water jet.
- Remove detergent and cleaning agent residue immediately.
- Some water may collect between the window and the seal during drying. This does not affect the proper operation of your dryer in any way.

### Filter in the condensate container

The filter is cleaned automatically when the condensate container is emptied. However, the filter should still be cleaned regularly under running water → This prevents stubborn deposits/dirt from building up.

1. Pull out the condensate container.

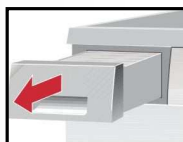

2. Pull the filter out of its snap-in lock.

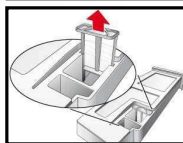

3. Clean the filter under running water or in the dishwasher.



4. Refit the filter.
5. Insert the condensate container so that it locks into place.

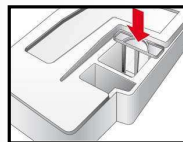

Only operate the dryer with the filter inserted.

### Moisture sensors

The dryer is equipped with stainless steel moisture sensors. Moisture sensors measure the moisture level of the laundry. After sustained, repeated operation, a fine layer of limescale may form on the moisture sensors.

1. Open the door.
2. Clean the moisture sensors with a damp sponge which has a rough surface.

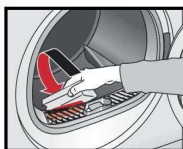

Do not use steel wool or abrasive agents!

## Installation

- Scope of delivery: dryer, operating and installation instructions, basket for woollens (*depending on the model*).
- Check the dryer for transport damage.
- The dryer is very heavy. Do not attempt to lift it on your own.
- Be careful to avoid sharp edges.
- Do not lift the dryer by protruding parts (e.g. the door) - risk of breakage.
- Do not set up in a room that is susceptible to frost. Freezing water may cause damage.
- If in doubt, have the appliance connected by a specialist.

1.

### Setting up the dryer

- The mains plug must always be accessible.
- Ensure that the appliance is placed on a clean, level and firm surface.
- Do not obstruct the air inlet on the dryer.
- Keep the area around the dryer clean.
- Level the dryer using the threaded feet and a spirit level. Never remove the threaded feet!



Do not install the dryer behind a door or sliding door which could prevent or obstruct the dryer door from opening. This will prevent children from locking themselves in and risking their lives.



Take all accessory parts out of the drum. The drum must be empty.

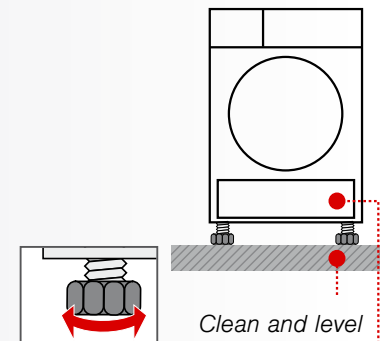

Clean and level  
Make sure that the air inlet remains unobstructed

2.

### For mains connection, see Safety instructions → page 13.

- Connect to an AC earthed socket. If in doubt have the socket checked by a specialist.
- The mains voltage and the voltage shown on the rating plate (→ page 10) must be the same.
- The connected load and necessary fuse protection are specified on the rating plate.

## Frost protection



Do not operate the dryer if there is a risk of frost.



### Preparation

1. Empty the condensate container → page 4,8/12.
2. Select any programme using the programme selector.
3. Press the **Start/Reload** button → condensation is pumped into the container.
4. Wait several minutes or until the dryer stops, and then empty the condensate container again.
5. Turn the programme selector to **Off**.

## Transport



- Prepare the dryer → see *Frost protection*.
- Transport the dryer in a vertical upright position.
- Following transportation, do not use the dryer for two hours.



The dryer contains residual water; this can flow out if the dryer is tilted.

## Technical Data

● <b>Dimensions (DxWxH)</b>	60 x 60 x 85 cm (height adjustable)	
<b>Weight</b>	approx. 51 kg	
<b>Max. capacity</b>	8 kg	
<b>Condensate container</b>	4.0 l	
<b>Connection voltage</b>	220-240 V	
<b>Connected load</b>	1000 W	
<b>Fuse protection</b>	10 A	
<b>Ambient temperature</b>	5 - 35°C	
<b>Product number Production number</b>	Inside of door	
The rating plate can be found on the back of the dryer.		
<b>Power consumption when switched off</b>	0.10 W	
<b>Power consumption when ready for use (left-on mode)</b>	1.00 W	
● <b>Drum interior light</b> (depending on model):	The drum lights up after the door is opened and after the programme starts, and switches off automatically.	

## Consumption values table

Programme	Spin speed which is used for spinning the laundry	Duration**		Energy consumption**	
		8 kg	4 kg	8 kg	4 kg
Cupboard Dry*	1400 rpm	179 min	111 min	1.57 kWh	0.93 kWh
	1000 rpm	203 min	122 min	1.80 kWh	1.04 kWh
	800 rpm	227 min	143 min	2.04 kWh	1.25 kWh
Iron Dry*	1400 rpm	125 min	75 min	1.10 kWh	0.66 kWh
	1000 rpm	150 min	90 min	1.36 kWh	0.82 kWh
	800 rpm	176 min	106 min	1.64 kWh	0.98 kWh
<b>Easy-Care</b>		<b>3.5 kg</b>		<b>3.5 kg</b>	
Cupboard Dry*	800 rpm	55 min		0.51 kWh	
	600 rpm	71 min		0.66 kWh	

\* Programme setting for testing in accordance with the applicable EN61121 standard.

\*\* The values may differ from those specified, depending on the type of fabric, composition of laundry to be dried, residual moisture in the fabric, the degree of dryness that has been set, the amount of laundry being loaded and the environmental conditions.

## Most efficient programme for cotton fabrics

The following "standard cottons programme" (identified with ☐) is suitable for drying normal, wet cotton laundry and is most efficient in terms of its combined energy consumption for drying wet cotton laundry.

Standard programme for cottons in accordance with current EU regulation 932/2012

Programme	Load	Energy consumption	Programme duration
☐ Cottons Cupboard Dry	8 kg/4 kg	1.80 kWh/1.04 kWh	203 min/122 min

Programme setting for testing and energy labelling in accordance with Directive 2010/30/EU.

## Optional accessories (order from the after-sales service using the order number, depending on the model)

**WTZ 20410 Washer-dryer stack connection set**  
The dryer can be placed on top of a suitable washing machine with the same width and depth to save space. The dryer **must be** fastened to the washing machine using this connection set.  
WTZ 11400: with pull-out worktop.

**Platform**  
For easier loading and unloading. The basket contained in the drawer can be used to carry the laundry.

**Wollens basket**  
For drying **individual** wollen fabrics, sports shoes and soft toys (see separate instructions for "Woollens basket").

## Normal noises

During drying, the compressor and the pump generate some noise which is entirely normal.

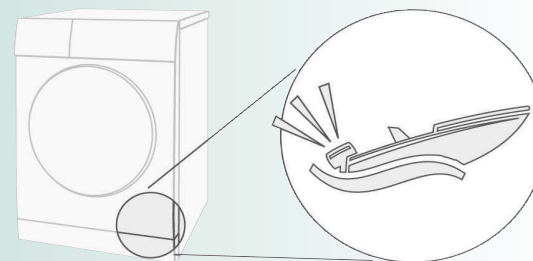

The compressor in the dryer may occasionally generate a humming noise. The volume and pitch of this may vary depending on the selected programmes and the progress of the drying.

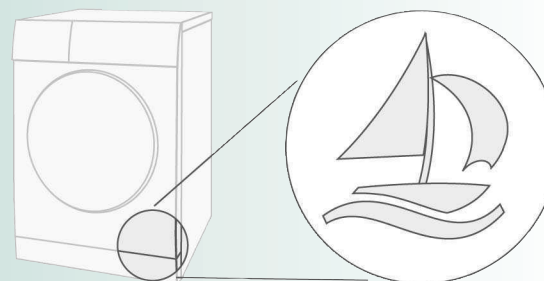

The compressor in the dryer is ventilated from time to time, which creates a whirring sound.

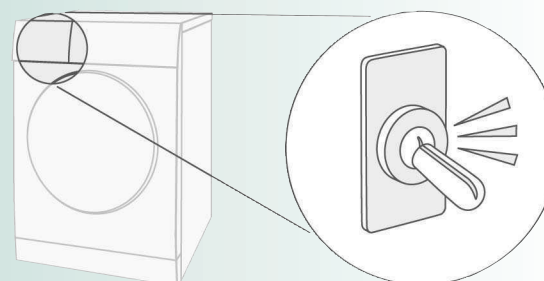

The automatic cleaning process causes a clicking noise.

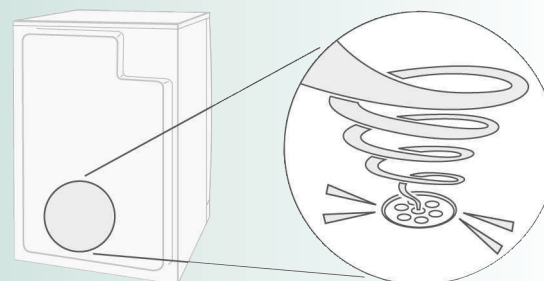



The process of pumping the condensation into the condensate container generates pumping noises.



# What to do if ...



Turn the programme selector to **Off** and remove the mains plug from the socket.

The <b>Start/Reload</b> indicator light does not light up.	Mains plug plugged in? Programme selected? Check the socket fuse.
The display panel light and indicator lights ( <i>depending on model</i> ) go out and the <b>Start/Reload</b> indicator light flashes.	Energy-saving mode is activated → see the separate <i>Energy-saving mode</i> instructions.
The display panel switches off.	The appliance goes into the sleep mode after activating <b>Finished in</b> option → <i>page 5</i> .
The  ( <b>Condensate container</b> ) indicator light flashes.	Empty the condensate container → <i>page 4</i> . Press the <b>Start/Reload</b> button to reset the displayed indication and then press the <b>Start/Reload</b> button again to restart the appliance if necessary.
 ( <b>Fluff filter</b> ) indicator light flashes.	Clean the fluff filter → <i>page 4/8</i> . Press the <b>Start/Reload</b> button to reset the displayed indication and then press the <b>Start/Reload</b> button again to restart the appliance if necessary.
<b>SELF CLEANING</b> appears in the display panel.	Not an error. Automatic cleaning of the heat exchanger. Do not empty the condensate container.
Dryer does not start.	<b>Start/Reload</b> button selected? Door closed? Ambient temperature greater than 5°C? The optimum ambient temperature for drying is between 5 °C and 35 °C.
Programme terminates shortly after starting.	Is the appliance loaded with the laundry? Load too small for selected programme?/Use timed programme → <i>page 6/7</i> . Loaded laundry dry?
Water is leaking out.	Make sure the dryer is level.
The door opens by itself.	Push the door closed until you hear it engage.
Creasing.	Laundry load exceeded? Remove articles of clothing immediately after the end of the programme, hang up and pull into shape. Unsuitable programme selected → <i>page 7</i> .
Laundry is not dried correctly or is still too damp.	After the end of the programme, warm laundry feels damper than it actually is. Spread the laundry out and allow the heat to disperse.  Finely adjust the dryness level – this extends the drying time but does not increase the temperature. Your laundry will become drier.  Select a programme with a longer drying time or increase the drying level. This does not increase the temperature.  Select a time programme for extended drying of laundry that is still damp.  If you have exceeded the maximum load for the programme, the laundry may not be dried correctly.  Clean the moisture sensor in the drum. A fine layer of limescale may adversely affect the performance of the sensors and your washing will not dry properly.  Drying has been interrupted as a result of a power cut, because the condensate container is full or because the maximum drying time has been exceeded.
Drying time too long.	Clean the fluff filters under running water → <i>page 4/8</i> .  Insufficient supply of air → Ensure that air can circulate.  Air inlet possibly blocked → Clear inlet → <i>page 9</i> .  Ambient temperature higher than 35°C → Ventilate the room. The optimum ambient temperature for drying is between 5 °C and 35 °C. Outside of this range, the drying time may increase.
One or more indicator lights are flashing.	Clean the fluff filter → <i>page 4,8/12</i> . Check the installation conditions → <i>page 9</i> . Switch off, allow to cool, switch back on and restart the programme.
Power failure.	Remove the laundry from the dryer immediately and spread out. This allows the heat to dissipate. Be careful as the door, the drum and the laundry may be hot.
Other intermittent noises and vibrations.	Not an error. Normal noises → <i>page 11</i> .
Loud humming noise for several seconds.	Has the condensate container been properly inserted? → Push the condensate container all the way in. Not an error. Normal noises → <i>page 11</i> .

# After-sales service

If you cannot rectify the fault yourself (e.g. switching off/on) → *What to do if...*, *page 12*, please contact our after-sales service. We will always find an appropriate solution and avoid unnecessary visits by engineers.

The contact details of your local **after-sales service** can be found in the enclosed after-sales service directory. Please provide the after-sales service the product number (E no.) and the production number (FD) of the appliance.  
– **GB** 03 448 928 979 (Calls charged at local or mobile rate.)  
– **IE** 01450 2655 (0.03 € per minute at peak. Off peak 0.0088 € per minute.)

E-Nr. _____	FD _____
-------------	----------

Product number

Production number

You can find this information: inside the door\* / in the opened service flap\* and on the rear of the appliance.  
\*depending on the model

Trust the expertise of the manufacturer. Contact us for assistance. In this way, you can rest assured that the repair will be carried out by trained service technicians using original spare parts.

# Safety instructions



## Emergency

**ONLY use the dryer...**

**The dryer must NEVER...**

## Hazards

## Installation

## Mains connection

## Operation

## Defect

## Spare parts

## Disposal

- Pull the appliance plug out of the socket immediately or disconnect the fuse.
- in rooms inside the house.
- to dry fabrics.
- be used for purposes other than those described above.
- be modified in terms of its technology or properties.
- The dryer must not be used by children or persons who have not been instructed in its use.
- Do not leave children unsupervised near the dryer.
- Keep pets away from the dryer.
- Remove all objects from pockets, and lighters in particular → **Risk of explosion**.
- Do not lean or sit on the door → **Risk of tipping**.
- Secure loose cables → **Risk of tripping**.
- Do not operate a dryer if there is a risk of frost.
- Connect the dryer to an AC earthed socket according to specifications, otherwise it cannot be guaranteed that the appliance is completely safe.
- The cable cross-section must be sufficient.
- Only use earth-leakage circuit breakers with the following symbol: 
- The appliance plug and socket must be compatible.
- Do not use multiple plugs/connectors and/or extension cables.
- Do not touch or hold the appliance plug with wet hands → **Risk of electric shock**.
- Never pull the appliance plug out of the socket by its cable.
- Do not damage the mains lead → **Risk of electric shock**.
- Only load the drum with laundry. Check the contents before you switch the dryer on.
- Do not use the dryer if the laundry has been in contact with solvents, oil, wax, grease or paint (e.g. hair styling products, nail varnish remover, stain remover, cleaning solvent, etc.) → **Risk of fire/explosion**.
- The tumble dryer is not to be used if industrial chemicals have been used for cleaning.
- Dust (e.g. coal dust, flour) poses a danger: Do not use the dryer → **Risk of explosion**.
- Do not turn off the dryer until the drying process ends, unless the laundry will be removed quickly and spread out, so that the heat can dissipate.
- Do not put laundry containing foamed material/rubber in the dryer → elastic material may be destroyed and the dryer be damaged due to possible deformation of the foamed material.
- When cleaning the fluff filter, make sure that no foreign material (down or filling material) gets into the air duct opening. If necessary, clean the drum beforehand with a vacuum cleaner. If foreign material should still get into the air duct → call the after-sales service → **Risk of fire/explosion**.
- Light things, such as long hair, may be sucked into the air inlet of the dryer → **Risk of injury**.
- Final part of a tumble dryer cycle occurs without heat (cool down cycle), to ensure that the items are left at a temperature that ensures that the items will not be damaged.
- Switch off the dryer once the programme has ended.
- The water from condensation is not drinking water and may be contaminated with fluff.
- Do not use the dryer if it is defective or if you suspect that it is. Repairs must only be carried out by the after-sales service.
- Do not use the dryer if the mains cable is defective. To avoid danger, only have the defective mains cable replaced by the after-sales service.
- For safety reasons, you must only use genuine spare parts and accessories.
- Pull out the appliance plug, **then** cut off the mains cable from the appliance.
- Dispose of the appliance at a municipal waste disposal facility.
- Heat exchangers contain a fluorinated greenhouse gas (R134a) in hermetically sealed equipment → dispose of in a proper manner. Capacity: 0.220 kg. Total GWP: 0.315 tCO<sub>2</sub>.
- Packaging: Keep all packaging out of reach of babies and children → **Risk of suffocation**.
- All materials are environmentally sound and can be reused.
- Dispose of them in an environmentally-responsible manner.



Register your new Bosch now:  
[www.bosch-home.com/welcome](http://www.bosch-home.com/welcome)



**Dryer**  
**WTW85250GB**



**BOSCH**

**en** Instruction manual