



Register your new Bosch now:
www.bosch-home.com/welcome



**Hob
PXY8...**



BOSCH

en Instruction manual



		g^*	b^*
A / B		2.200 W	3.700 W
		3.300 W	3.700 W
		2.600 W	3.700 W
		3.300 W	3.700 W

* IEC 60335-2-6

Table of contents

 Intended use	4	 Keep warm function	18
 Important safety information	4	Activating	18
 Causes of damage	6	Deactivating	18
Overview	6	 Transferring settings	18
 Environmental protection	6	Activation	18
Energy-saving advice	6	 Cooking assist functions	19
Environmentally-friendly disposal	6	Cooking assistant function types	19
 Induction cooking	7	Suitable cookware	19
Advantages of induction cooking	7	Sensors and special accessories	20
Cookware	7	Functions and heat settings	20
 Getting to know your appliance	8	Recommended dishes	23
The control panel	8	Dishes	28
The cooking zones	9	Preparing and maintaining the wireless temperature sensor	29
Overview of the menus	9	Declaration of Conformity	30
Cooking modes	10	 Childproof lock	31
Residual heat indicator	10	Activating and deactivating the childproof lock	31
 Operating the appliance	10	Childproof lock	31
Switching the hob on and off	10	 Wipe protection	31
Setting the cooking zone	10	 Automatic safety cut-out	31
Chef's recommendations	11	 Basic settings	32
 Flex Zone	13	 Energy consumption indicator	33
Advice on using cookware	13	 Cookware check	33
Use as a linked cooking zone	13	 Cleaning	34
Use as two independent cooking zones	13	Hob	34
 Move function	14	Hob surround	34
Activation	14	Wireless temperature sensor	34
Deactivating	14	 Frequently Asked Questions (FAQ)	35
 FlexPlus Zone	15	 Trouble shooting	36
Notes regarding cookware	15	Information, warnings and fault messages	36
Activation	15	Tips	36
Deactivating	15	Demo mode	36
 Time-setting options	15	 Customer service	37
Programming the cooking time	15	E number and FD number	37
Kitchen timer	15	 Test dishes	38
Stopwatch function	16		
 PowerBoost function	16		
Activating	16		
Deactivating	17		
 ShortBoost function	17		
Recommendations for use	17		
Activating	17		
Deactivating	17		

Additional information on products, accessories, replacement parts and services can be found at www.bosch-home.com and in the online shop www.bosch-eshop.com

Intended use

Read these instructions carefully. Please keep the instruction and installation manual, as well as the appliance certificate, in a safe place for later use or for subsequent owners.

Check the appliance after removing it from the packaging. If it has suffered any damage in transport, do not connect the appliance, contact the Technical Assistance Service and provide written notification of the damage caused, otherwise you will lose your right to any type of compensation.

This appliance must be installed according to the installation instructions included.

This appliance is intended for private domestic use and the household environment only. The appliance must only be used for the preparation of food and beverages. The cooking process must be supervised. A short cooking process must be supervised without interruption. Only use the appliance in enclosed spaces.

This appliance is intended for use up to a maximum height of 4000 metres above sea level.

Do not use covers. These can cause accidents, due to overheating, catching fire or materials shattering, for example.

Do not use inappropriate child safety shields or hob guards. These can cause accidents.

This appliance is not intended for operation with an external clock timer or a remote control.

This appliance may be used by children over the age of 8 years old and by persons with reduced physical, sensory or mental capabilities or by persons with a lack of experience or knowledge if they are supervised or are instructed by a person responsible for their safety how to use the appliance safely and have understood the associated hazards.

Children must not play with, on, or around the appliance. Children must not clean the appliance or carry out general maintenance unless they are at least 8 years old and are being supervised.

Keep children below the age of 8 years old at a safe distance from the appliance and power cable.

Always monitor the cooking process. Short cooking processes must be monitored continuously.

We advise that you exercise caution using or standing near an induction hob while it is in operation, if you wear a pacemaker or a similar medical device. Consult your doctor or the device manufacturer concerning its conformity or any possible incompatibilities,

If you wear an active implantable medical device (e.g. a pacemaker or defibrillator), check with your doctor that it complies with Council Directive 90/385/EEC of 20th June 1990, DIN EN 45502-2-1 and DIN EN 45502-2-2, and that it has been chosen, implanted and programmed in accordance with VDE-AR-E 2750-10. If these conditions are satisfied, and if, in addition, non-metal cooking utensils and cookware with non-metal handles are used, it is safe to use this induction hob as intended.

Important safety information

Warning – Risk of fire!

- Hot oil and fat can ignite very quickly. Never leave hot fat or oil unattended. Never use water to put out burning oil or fat. Switch off the hotplate. Extinguish flames carefully using a lid, fire blanket or something similar.
- The hotplates become very hot. Never place combustible items on the hob. Never place objects on the hob.
- The appliance gets hot. Do not keep combustible objects or aerosol cans in drawers directly underneath the hob.
- The hob switches off automatically and can no longer be operated. It may switch on unintentionally at a later point. Switch off the circuit breaker in the fuse box. Contact the after-sales service.

⚠ Warning – Risk of burns!

- The hotplates and surrounding area (particularly the hob surround, if fitted) become very hot. Never touch the hot surfaces. Keep children at a safe distance.
- The hotplate heats up but the display does not work. Switch off the circuit breaker in the fuse box. Contact the after-sales service.
- Metal objects on the hob quickly become very hot. Never place metal objects (such as knives, forks, spoons and lids) on the hob.
- After each use, always turn off the hob at the main switch. Do not wait until the hob turns off automatically after the pan is removed.

⚠ Warning – Risk of electric shock!

- Incorrect repairs are dangerous. Repairs may only be carried out and damaged power cables replaced by one of our trained after-sales technicians. If the appliance is defective, unplug the appliance from the mains or switch off the circuit breaker in the fuse box. Contact the after-sales service.
- Do not use any high-pressure cleaners or steam cleaners, which can result in an electric shock.
- A defective appliance may cause electric shock. Never switch on a defective appliance. Unplug the appliance from the mains or switch off the circuit breaker in the fuse box. Contact the after-sales service.
- Cracks or fractures in the glass ceramic may cause electric shocks. Switch off the circuit breaker in the fuse box. Contact the after-sales service.

⚠ Warning – Hazard due to magnetism!

The wireless temperature sensor is magnetic. The magnetic elements in it may damage electronic implants, e.g. pacemakers or insulin pumps. People fitted with electronic implants should therefore not carry the temperature sensor in their pockets and always keep it at least 10 cm away from their pacemaker or similar medical device.

⚠ Warning – Malfunction risk!

The hob is equipped with a fan in the lower section. If there is a drawer under the hob it should not be used to store small objects or paper, since they could damage the fan or interfere with the cooling if they are sucked into it.

There should be a minimum of 2 cm between the contents of the drawer and fan intake.

⚠ Warning – Risk of injury!

- The battery in the wireless temperature sensor may become damaged or explode if it gets too hot. Remove the sensor from the hob after cooking and do not store it near sources of heat.
- The temperature sensor may be very hot when removing it from the saucepan. Wear oven gloves or use a tea towel to remove it.
- When cooking in a bain marie, the hob and cooking container could shatter due to overheating. The cooking container in the bain marie must not directly touch the bottom of the water-filled pot. Only use heat-resistant cookware.
- Saucepans may suddenly jump due to liquid between the pan base and the hotplate. Always keep the hotplate and saucepan bases dry.

Causes of damage

Caution!

- Rough pan bases may scratch the hob.
- Avoid leaving empty pots and pans on the hotplate. Doing so may cause damage.
- Do not place hot pans on the control panel, the indicator area, or the hob frame. Doing so may cause damage.
- Hard or pointed objects dropped on the hob may damage it.
- Aluminium foil and plastic containers will melt if placed on the hotplate while it is hot. The use of laminated sheeting is not recommended on the hob.

Overview

You will find the most frequently caused damage in the following table:

Damage	Cause	Measure
Stains	Boiled over food.	Remove boiled over food immediately with a glass scraper.
	Unsuitable cleaning agent.	Only use cleaning agents that are suitable for this type of hob.
Scratches	Salt, sugar and sand.	Do not use the hob as a work surface or storage space.
	Cookware with rough bases scratch the hob.	Check the cookware.
Discolouration	Unsuitable cleaning agent.	Only use cleaning agents that are suitable for this type of hob.
	Pan abrasion.	Lift pots and pans when moving them.
Chips	Sugar, food with a high sugar content.	Remove boiled over food immediately with a glass scraper.

Environmental protection

In this section, you can find information about saving energy and disposing of the appliance.

Energy-saving advice

- Always use the correct lid for each pan. Cooking without a lid uses a lot more energy. Use a glass lid to provide visibility and avoid having to lift the lid.
- Use pans with flat bases. Bases that are not flat use a lot more energy.
- The diameter of the pan base must match the size of the hotplate. Please note: pan manufacturers usually provide the diameter for the top of the pan, which is usually larger than the diameter of the pan base.
- Use a small pan for small amounts of food. A large pan which is not full uses a lot of energy.
- Use little water when cooking. This saves energy and preserves all the vitamins and minerals in vegetables.
- Select the lowest power level to maintain cooking. If the power level is too high, energy is wasted.

Environmentally-friendly disposal

Dispose of packaging in an environmentally-friendly manner.



This appliance is labelled in accordance with European Directive 2012/19/EU concerning used electrical and electronic appliances (waste electrical and electronic equipment - WEEE). The guideline determines the framework for the return and recycling of used appliances as applicable throughout the EU.

The wireless temperature sensor is battery-powered. Dispose of used batteries in an environmentally responsible manner.

Induction cooking

Advantages of induction cooking

Induction cooking is very different from traditional cooking methods, as heat builds up directly in the item of cookware. This offers numerous advantages:

- Saves time when boiling and frying.
- Saves energy.
- Easier to care for and clean. Spilled food does not burn on as quickly.
- Heat control and safety – the hob increases or decreases the heat supply as soon as the user changes the setting. The induction hotplate stops the heat supply as soon as the cookware is removed from the hotplate, without having to switch it off first.

Cookware

Only use ferromagnetic cookware for induction cooking, such as:

- Cookware made from enamelled steel
- Cookware made from cast iron
- Special induction-compatible cookware made from stainless steel.

To check whether your cookware is suitable for induction cooking, refer to the section on → "Cookware check".

To achieve a good cooking result, the ferromagnetic area on the base of the pan should match the size of the cooking zone. If a cooking zone does not detect the cookware, try placing the cookware on another cooking zone with a smaller diameter.

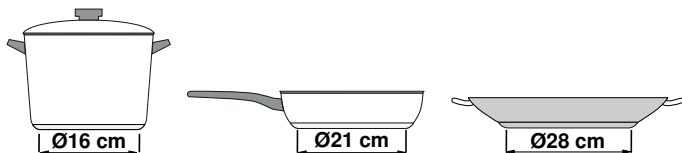

If the only cooking zone being used is the flexible cooking zone, larger cookware that is particularly suited to this zone can be used. You can find information on positioning cookware in the section entitled → "Flex Zone".



Some induction cookware does not have a fully ferromagnetic base:

- If the base of the cookware is only partially ferromagnetic, only the area that is ferromagnetic will heat up. This may mean that heat will not be distributed evenly. The non-ferromagnetic area may not heat up to a sufficient temperature for cooking.

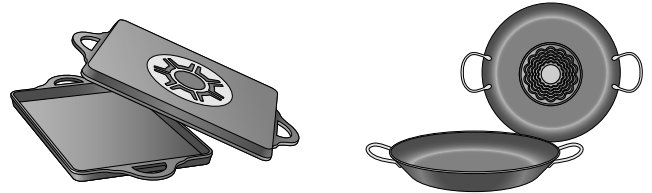

- The ferromagnetic area will also be reduced if the material from which the base of the cookware is made contains aluminium, for example. This may mean that the cookware will not become sufficiently hot or even that it will not be detected.

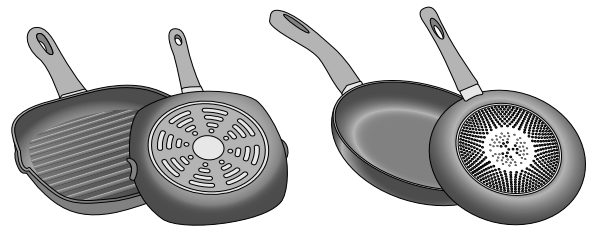

Unsuitable pans

Never use diffuser hobs or pans made from:

- common thin steel
- glass
- earthenware
- copper
- aluminium

Properties of the base of the cookware

The material(s) from which the base of the cookware is made can affect the cooking result. Using pots and pans made from materials that distribute heat evenly through them, such as stainless-steel pans with a three-layer base, saves time and energy.

Use cookware with a flat base; if the base of the cookware is uneven, this may impair the heat supply.

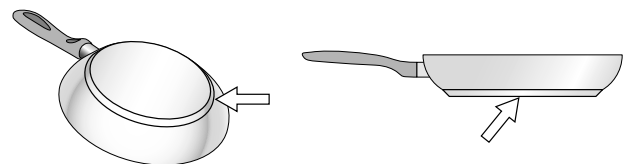

No cookware on the cooking zone or cookware of an unsuitable size

If no cookware has been placed on the selected cooking zone, or if the cookware is the wrong size or made from an unsuitable material, the displayed power setting will flash. Place suitable cookware on the cooking zone. The power setting for the cooking zone will stop flashing. Otherwise, the cooking zone will automatically switch itself off after 90 seconds.

Empty cookware and thin-bottomed cookware

Do not heat up saucepans or frying pans when they are empty, and do not use thin-bottomed cookware. If you do, the cookware may heat up very quickly and the safety cut-out may not be activated in time. This may cause the base of the cookware to melt and the glass-ceramic hob may be damaged. Never touch cookware when it is hot. Switch off the cooking zone. If the hob no

longer works once everything has cooled down, call the after-sales service.

Pan detection









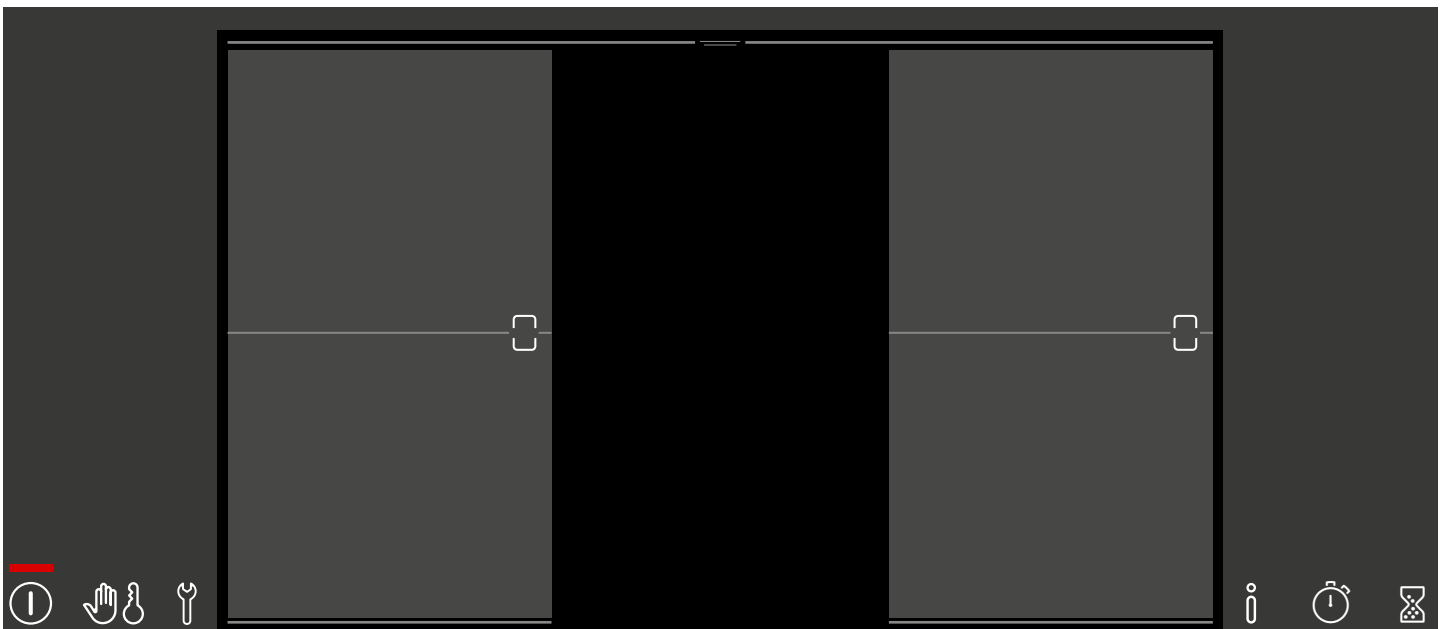



Each cooking zone has a lower limit for pan detection. This depends on the diameter of the ferromagnetic area of the cookware and the material from which its base is made. You should always use the cooking zone that



Getting to know your appliance

This section allows you to familiarise yourself with the displays, controls and various functions of your appliance.



The control panel



Controls	
	Main switch
	Wipe protection/childproof lock
	Basic settings
	Info menu
	FlexZone
	Programming the cooking time
	Stopwatch function
	Kitchen timer
	Heat settings
0-9	Heat settings
	Keep-warm function
	Move function
	PowerBoost function
	ShortBoost function

Controls	
	Frying sensor
	Cooking sensor
	Assist

The cooking zones

Cooking zone		
	Single cooking zone	Use cookware that is a suitable size.
	Flexible cooking zone	See the section entitled → "Flex Zone"
	FlexPlus cooking zone	The FlexPlus cooking zones always switch on in conjunction with the flexible cooking zone to their left or right. See the section entitled → "FlexPlus Zone"

Only use cookware that is suitable for induction cooking; see the section entitled → "Induction cooking"

Overview of the menus

The intuitive menu structure helps you to find your way around the control panel of your hob. You can find out more about the most important menus in this section.

Main area

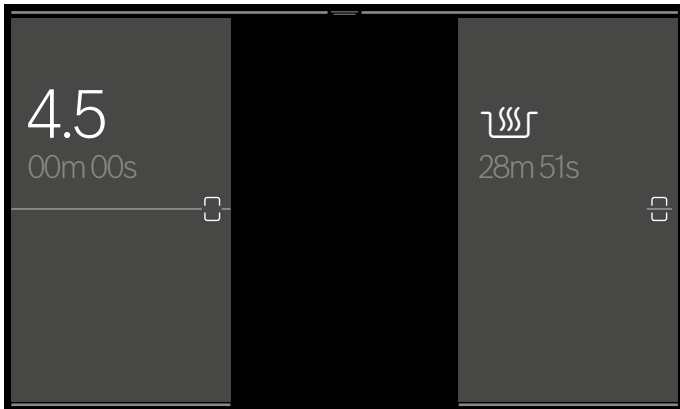

The main area provides an overview of the individual cooking zones and the way they are arranged on your hob. You can view the selected types of heating, power settings and time-setting options for your active heat settings. Touching a cooking zone takes you to the control panel for the cooking zone.

Control panel

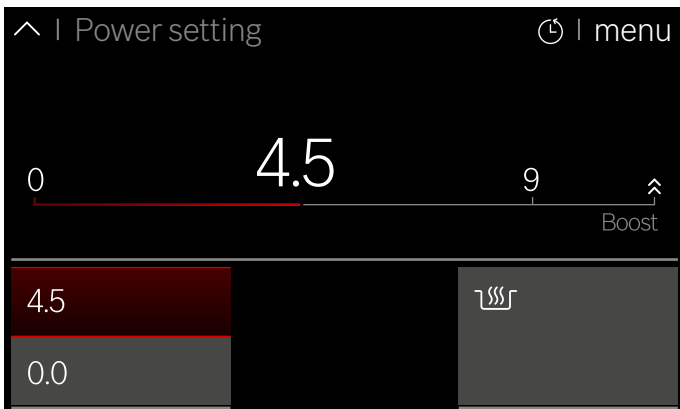

You can set the various cooking modes and power settings for a cooking zone on the corresponding control panel. You can change the power settings by touching them directly or swiping along the scale. You can change cooking modes by touching the "Menu" button and selecting a different cooking mode.

Status bar

Drag the bar in the centre of the top edge of the screen downwards to open the status bar.

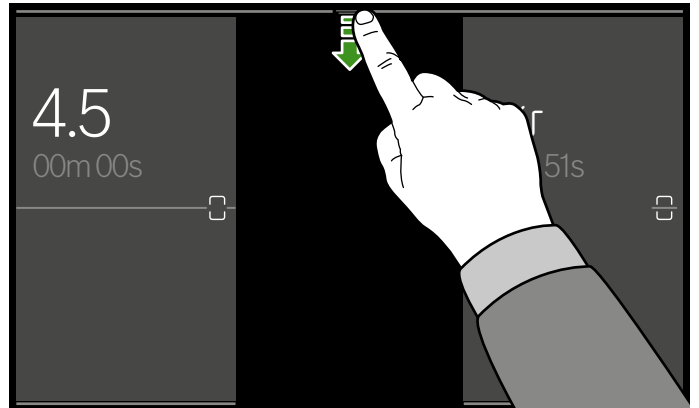

The status bar provides quick access to the timer and the count-up timer.

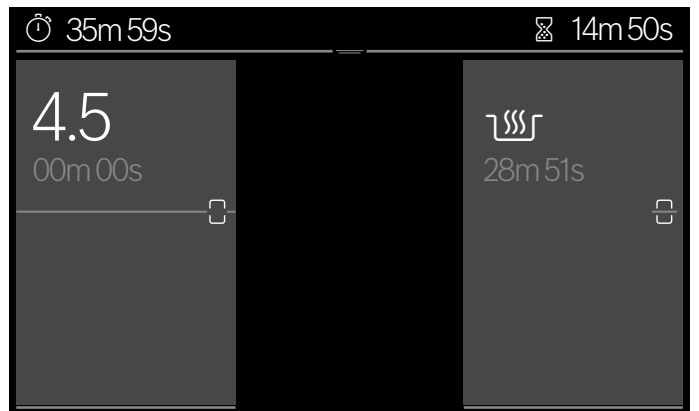

Drag the status bar up again to close it.

Info menu

Use the **i** touch key to access the info menu. Here you can find information about the functions of your appliance.

You can also find information about current functions outside of the info menu. To do this, touch the required field on the touchscreen for a few seconds. An info window will appear that describes the current function.

Cooking modes

Your hob has a number of different cooking modes. You can switch between the different modes in the cooking mode menu. You can access this menu by touching the current cooking mode in the control panel.

Cooking mode	Function
Power setting	Manually setting the temperature
Move function	Setting the temperature by changing the position of the cookware on the cooking zones
PowerBoost	Supplying more heat than at power setting 9.0
ShortBoost	Briefly supplying more heat than PowerBoost
Keep warm	Keeping food warm
Frying sensor	Frying with automatic temperature sensing by the hob
Cooking functions	Cooking with automatic temperature sensing by the wireless temperature sensor
Dishes	Frying and cooking with preselected settings for particular dishes

Residual heat indicator

The hob has a residual heat indicator for each cooking zone. If it is on, this means that the cooking zone in question is still hot. Do not touch the cooking zone if its field on the display is backlit in red.

When the cooking zone is switched off after cooking, the residual heat indicator will light up. Even after the hob has been switched off, the residual heat indicator will remain lit for as long as the cooking zone remains warm.

Operating the appliance

This section tells you how to apply settings for a cooking zone. The table shows power settings and cooking times for various meals.

Switching the hob on and off

The main switch is used to switch the hob on and off. To switch on, press the **ⓘ** button. A signal will sound and the touch display will light up. After a short switch-on time, the hob will be ready for operation.

To switch off, press the **ⓘ** button until the indicators go out. The residual heat indicator will remain lit until the cooking zones have cooled down sufficiently.

Notes

- The hob will automatically switch itself off if all hotplates have been switched off for more than 20 seconds.
- The selected settings are stored for 10 minutes after the hob has been switched off. If you switch it back on during this time, the hob will operate using the stored settings.

Setting the cooking zone

Set the required power setting from 1 to 9.

Power setting 1 = lowest setting.

Power setting 9 = highest setting.

Each power setting has an intermediate level.

Selecting the cooking zone and power setting

The hob must be switched on.

1. Select the required cooking zone by touching it. The view changes in the control panel for the selected cooking zone.



2. Select the required power setting by touching it directly or swiping along the scale.

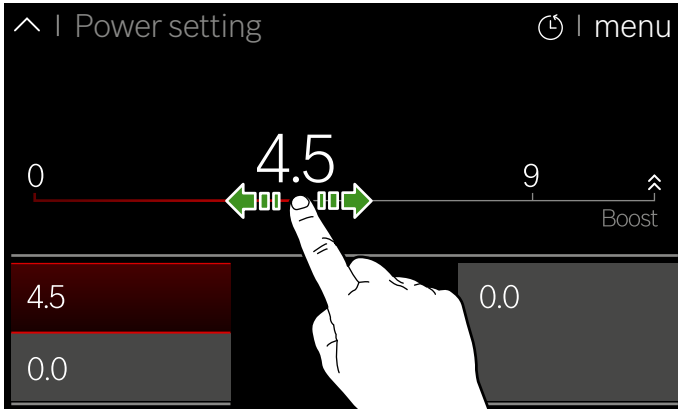

The power setting has now been applied and will be displayed in the panel for the selected cooking zone.

Touching the active cooking zone again returns to the main view.

Touching a different cooking zone switches directly to the control panel for that cooking zone.

Changing the power setting

Select a cooking zone and then set the new power setting in the control panel for that cooking zone.

Switching off the cooking zone

Select a cooking zone and set the power setting to 0 on the cooking zone's control panel. This switches off the cooking zone.

Notes

- If there is no cookware resting on an active cooking zone, the power setting indicator will flash. After a while, the cooking zone will switch itself off.
- If cookware is resting on a cooking zone that does not have a power setting selected, the cookware will be detected automatically. The cooking zone in question will light up.

Chef's recommendations

Recommendations

- Stir occasionally when heating up purees, creamy soups and thick sauces.
- Use power setting 8-9 for preheating.
- When cooking with the lid on, turn the power setting down as soon as steam starts to escape from between the lid and the cookware.
- After cooking, keep the lid on the cookware until you serve the food.
- To cook with the pressure cooker, follow the manufacturer's instructions.
- Do not cook food for too long, otherwise the nutrients will be lost. The kitchen timer can be used to set the required cooking time.
- For healthier cooking results, oil and grease should not be heated to their smoke point.
- To brown food, fry small portions in succession.
- Cookware may reach high temperatures while the food is cooking. We recommend that you use oven gloves.
- You can find recommendations for energy-efficient cooking in the section entitled → "Environmental protection"

Cooking table

The table shows which power setting is suitable for each type of food. The cooking time may vary depending on the type, weight, thickness and quality of the food.

	Power setting	Cooking time (mins)
Melting		
Chocolate coating	1 - 1.5	-
Butter, honey, gelatine	1 - 2	-
Heating and keeping warm		
Stew, e.g. lentil stew	1.5 - 2	-
Milk*	1.5 - 2.5	-
Heating sausages in water*	3 - 4	-
Defrosting and heating		
Spinach, frozen	3 - 4	15 - 25
Goulash, frozen	3 - 4	35 - 45

*Without lid

** Turn several times

	Power setting	Cooking time (mins)
Poaching, simmering		
Dumplings*	4.5 - 5.5	20 - 30
Fish*	4 - 5	10 - 15
White sauces, e.g. Béchamel sauce	1 - 2	3 - 6
Whisked sauces, e.g. Béarnaise sauce, Hollandaise sauce	3 - 4	8 - 12
Boiling, steaming, braising		
Rice (with twice the water quantity)	2.5 - 3.5	15 - 30
Rice pudding	2 - 3	30 - 40
Unpeeled boiled potatoes	4.5 - 5.5	25 - 35
Boiled potatoes	4.5 - 5.5	15 - 30
Pasta, noodles*	6 - 7	6 - 10
Stew, soups	3.5 - 4.5	15 - 120
Vegetables	2.5 - 3.5	10 - 20
Goulash, frozen	3.5 - 4.5	7 - 20
Cooking in a pressure cooker	4.5 - 5.5	-
Braising		
Roulades	4 - 5	50 - 65
Pot roast	4 - 5	60 - 100
Goulash	3 - 4	50 - 60
Roasting/frying with little oil*		
Escalope, plain or breaded	6 - 7	6 - 10
Escalope, frozen	6 - 7	8 - 12
Chops, plain or breaded**	6 - 7	8 - 12
Steak (3 cm thick)	7 - 8	8 - 12
Poultry breast (2 cm thick)**	5 - 6	10 - 20
Poultry breast, frozen**	5 - 6	10 - 30
Hamburger, rissoles (3 cm thick)**	4.5 - 5.5	20 - 30
Fish and fish fillet, plain	5 - 6	8 - 20
Fish and fish fillet, breaded	6 - 7	8 - 20
Fish, breaded and frozen, e.g. fish fingers	6 - 7	8 - 15
Scampi, prawns	7 - 8	4 - 10
Sautéing fresh vegetables and mushrooms	7 - 8	10 - 20
Stir-fry, vegetables, meat cut in strips Asian-style	7 - 8	15 - 20
Stir fry, frozen	6 - 7	6 - 10
Pancakes (baked in succession)	6 - 7	-
Omelette (cooked in succession)	3.5 - 4.5	3 - 6
Fried eggs	5 - 6	3 - 6
Deep-fat frying* (150-200 g per portion in 1-2 l oil, deep-fat fried in portions)		
Frozen products, e.g. chips, chicken nuggets	8 - 9	-
Croquettes, frozen	7 - 8	-
Meat, e.g. chicken portions	6 - 7	-
Fish, breaded or beer-battered	6 - 7	-
Vegetables, mushrooms, breaded or battered, tempura	6 - 7	-
Small baked items, e.g. doughnuts, beer-battered fruit	4 - 5	-

*Without lid

** Turn several times

Flex Zone

A flexible cooking zone can be used as a linked cooking zone or as two independent cooking zones, as required.

The flexible cooking zone consists of four inductors that work independently of each other. When the flexible cooking zone is in use, only the area that is covered by cookware is activated.

The hob has two independent cooking zones when it starts.

Advice on using cookware

To ensure that the cookware is detected and heat is distributed evenly, correctly centre the cookware:

As a linked cooking zone

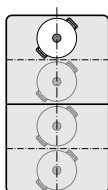

Diameter less than or equal to 13 cm
Place the cookware in one of the four positions that can be seen in the illustration.

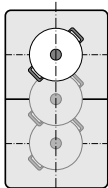

Diameter greater than 13 cm
Place the cookware in one of the three positions that can be seen in the illustration.

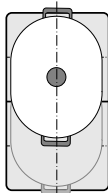

If the cookware takes up more than one cooking zone, place it starting on the upper or lower edge of the flexible cooking zone.

As two independent cooking zones

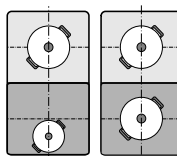

The front and rear cooking zones each have two inductors and can be used independently of one another. Set the required power setting for each individual cooking zone. Use only one item of cookware on each cooking zone.

Recommendations

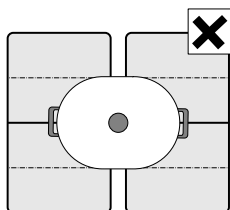

If the hob has more than one flexible cooking zone, set the cookware down so that it covers only one of the flexible cooking zones. Otherwise the cooking zones will not be activated as intended and the cooking result will not be satisfactory.

Use as a linked cooking zone

The flexible cooking zone is used as a linked cooking zone.

Connecting the two individual cooking zones

1. Set down the cookware.
2. Touch the  symbol between the two flexible cooking zones.

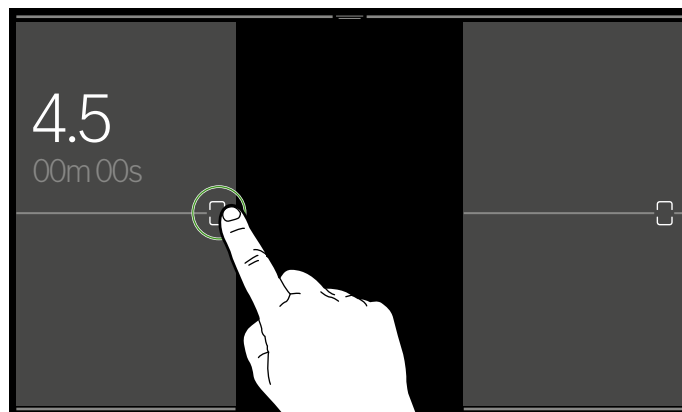

The two individual cooking zones are now connected to one another. You can change the power setting or the cooking mode for the entire linked cooking zone.

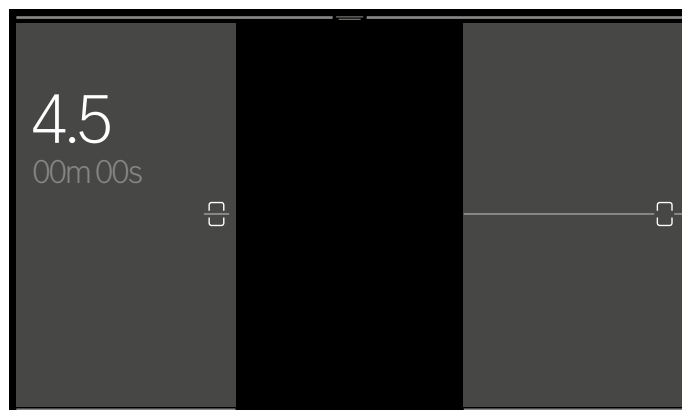

Note: When you switch the hob off and back on again later, the flexible cooking zone will be switched to two separate cooking zones again.

Use as two independent cooking zones

The flexible cooking zone is used like two independent cooking zones.

Separating the connected cooking zone

Touch the  symbol in the centre of the connected cooking zone.

The connected cooking zone is now deactivated. The two cooking zones will now operate independently of one another.



Move function

This function activates the entire flexible cooking zone and divides it into three flexible cooking areas. Each cooking area has a preset power setting.

Only use one item of cookware. The size of the cooking area depends on the cookware used and how it is positioned.

Cooking areas

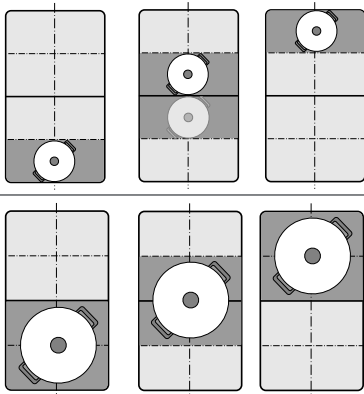

This function allows you to change the power setting at which your food is cooked simply by repositioning the cookware in a different zone.

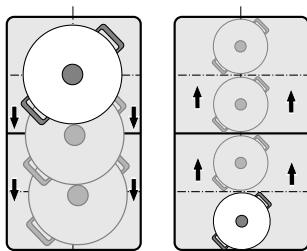

Preset power settings:

Front section = power setting 9.0

Middle section = power setting 5.0

Rear section = power setting 1

The preset power settings can be changed independently of one another. You can find out how to change these in section → "Basic settings".

Notes

- If more than one item of cookware is detected on the flexible cooking zone, the function will be deactivated.
- If the cookware is picked up or moved within the flexible cooking zone, the hob will begin an automatic search. The power setting for the new area is set.
- You can find information on the size and positioning of the cookware in the section on → "Flex Zone"

Activation

1. Select one of the two cooking zones in the flexible cooking zone.
2. Select the MoveMode function from the cooking mode menu.

This activates the function.

Changing the power settings

The power settings for the individual cooking areas can be changed as you cook. Set the cookware down on the cooking area and change the power setting on the control panel for the cooking area in question.

Note: If the function is deactivated, the power settings for the three cooking areas will be reset to the preset values.

Deactivating

Select a cooking zone and touch the "Switch off" button in the control panel. The cooking zone switches itself off and the residual heat indicator appears.

The function is deactivated.

FlexPlus Zone

The hob has two FlexPlus cooking zones, which are located between the two flexible cooking zones and which switch on in conjunction with the flexible cooking zone to their right or left. This means that larger cooking vessels can be used and better cooking results can be achieved.

Each of the two FlexPlus cooking zones automatically switches on in conjunction with the flexible cooking zone to its right or left. It is not possible to switch them on independently of their associated flexible cooking zone.

Notes regarding cookware

The cookware should be set down centrally for good pan detection and heat distribution.

The cookware should cover the side cooking zone and the expanded cooking zone.

Depending on the size of the cookware, the flexible cooking zone can be activated as two independent cooking zones or as a single cooking zone:

Setting down the cookware

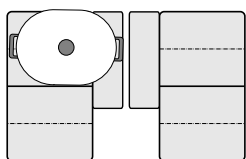

Oblong cookware:
Activate the flexible cooking zone as two independent cooking zones or as a single cooking zone.

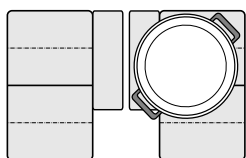

Large round cookware:
Activate the flexible cooking zone as a single cooking zone.

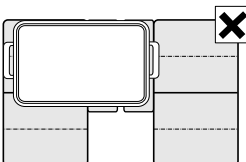

The cookware must not cover both FlexPlus cooking zones at the same time.

Activation

1. Set the cookware down on the cooking zone.
Note: Make sure that the cookware also covers the FlexPlus cooking zone.
2. Select the required cooking zone and power setting.

Doing this automatically activates the FlexPlus cooking zone – this is shown on the display.

Deactivating

Select a cooking zone and set the power setting to 0 in the control panel. The cooking zone switches itself off and the residual heat indicator appears.

This deactivates the FlexPlus cooking zone.

Time-setting options

Your hob has three time-setting options:

- Programming the cooking time
- Kitchen timer
- Stopwatch function

Programming the cooking time

The cooking zone switches off automatically once the time that is set has elapsed.

Setting procedure

1. Select the cooking zone and required power setting.
2. Touch the ⌚ symbol on the cooking zone's control panel.
3. Touch "Time to change". Set the required cooking time in hours and minutes.
4. Touch the ⏸ symbol.

The cooking time begins to elapse.

Notes

- You can exit this screen by touching the field for the selected cooking zone again. In this instance, the function will start up automatically if there is an item of cookware on the cooking zone that is selected.
- If the flexible cooking zone is selected as the only cooking zone, the set time for the entire cooking zone will be the same.

Frying sensor and cooking functions

If a cooking time has been programmed for a cooking zone and the frying sensor or a cooking function has been activated, the set cooking time will not start to count down until the selected temperature setting has been reached.

Changing or deleting the time

Touch the ⌚ symbol in the cooking zone's control panel to switch to the cooking time.

Touch the current cooking time. Select a new cooking time and touch the ⏸ symbol.

To delete the cooking time, touch the ⌚ symbol.

When the time has elapsed

The cooking zone will switch itself off. An audible signal will sound and the power setting will be set to 0.

Kitchen timer

The kitchen timer operates independently of the cooking zones and other settings. An audible signal will sound once the time has elapsed. This function does not automatically switch off a cooking zone.

Setting procedure

1. Touch the ⌚ key.
2. Touch the time that you want to change. Set the required time in hours and minutes.
3. Touch the ⏸ symbol
The time starts to elapse.

Note: You can exit this screen by touching the arrow in the top left corner of the touchscreen.

Changing or deleting the time

Switch to the kitchen timer by touching the current time in the status bar.

To change the time, set a new one. Then touch the  symbol. The kitchen timer will start with the new time.

To delete the time, touch the  symbol. The kitchen timer is deactivated.

When the time has elapsed

A signal will sound once the time has elapsed.

The display will go out after you touch the kitchen timer.

Stopwatch function

The stopwatch function displays the time that has elapsed since activation.

This operates independently of the cooking zones and other settings. This function does not automatically switch off a cooking zone.

Activating

Touch the  touch key.

The time will begin to elapse.

Deactivating

Switch to the stopwatch function by touching the current time in the status bar.

To deactivate the function and reset the time, touch the  symbol.

Note: You can exit this screen by touching the arrow in the top left corner of the touchscreen.

PowerBoost function

This function allows large volumes of water to be heated up even more quickly than with power setting 9. After 10 minutes, this function will automatically switch itself off.

This function can always be activated for a cooking zone, provided the other cooking zone in the same group is not in use (see illustration).

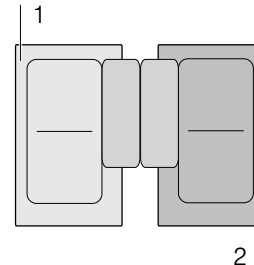

Note: The function can also be activated when using a flexible cooking zone, provided that the entire area is being used as a single cooking zone.

Activating

1. Select a cooking zone.
2. Swipe right on the scale until your finger touches "Boost". Hold your finger there.

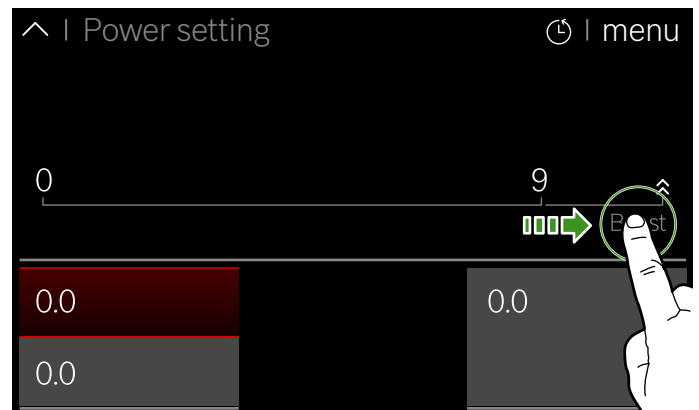

3. Touch the  symbol, then lift your finger off.

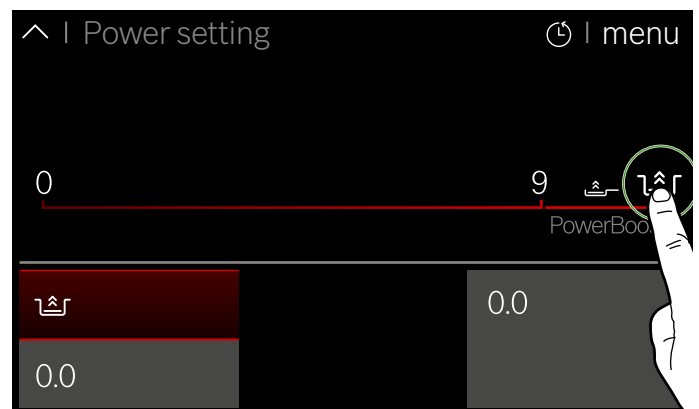

The function has now been activated.

Deactivating

Select a cooking zone and set another power level in the control panel.

The function is deactivated.

Note: In certain circumstances, the function may switch itself off automatically in order to protect the electronic elements inside the hob.

ShortBoost function

This function allows cookware to be heated up even more quickly than with power setting 9. This enables food to be heated up very quickly in the frying pan with only a small amount of oil or fat.

After 30 seconds, this function will automatically switch itself off.

After deactivating the function, select the appropriate ongoing cooking setting for your food.

This function can always be activated for a cooking zone, provided the other cooking zone in the same group is not in use (see illustration).

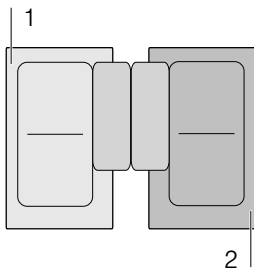

Note: The function can also be activated when using a flexible cooking zone, provided that the entire area is being used as a single cooking zone.

Recommendations for use

- Always use cookware that has not been pre-heated.
- Use pots and pans with a flat base. Do not use cookware with a thin base.
- Never leave empty cookware, oil, butter or lard to heat up unattended.
- Do not place a lid on the cookware.
- Place the cookware on the centre of the hotplate. Ensure that the diameter of the base of the cookware corresponds to the size of the hotplate.
- You can find information on the type, size and positioning of the cookware in section → "Induction cooking"

Activating

1. Select a cooking zone.
2. Swipe right on the scale until your finger touches "Boost". Hold your finger there.

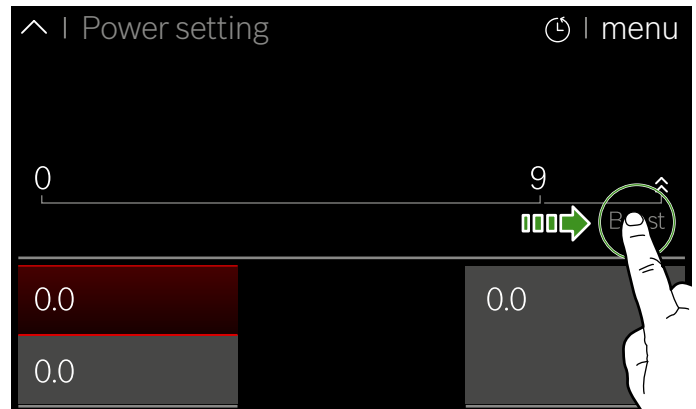

3. Touch the  symbol. Lift your finger off.

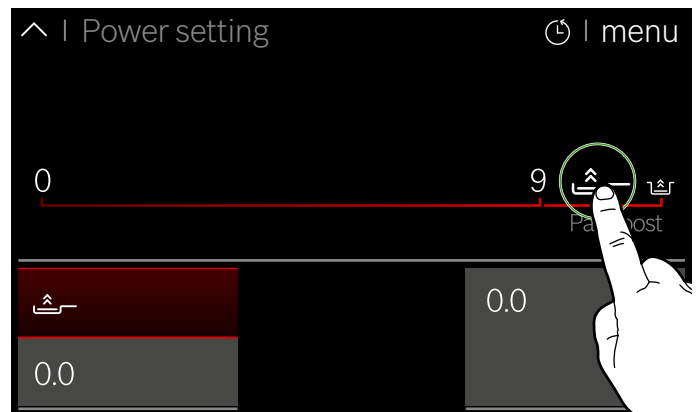

The function has now been activated.

Deactivating

Select a cooking zone and set another power level in the control panel.



The function is deactivated.

Note: In certain circumstances, the function may switch itself off automatically in order to protect the electronic elements inside the hob.

Keep warm function

This function is suitable for melting chocolate or butter and for keeping food warm.

Activating

1. Select the cooking zone you require.
2. Select the power setting  on the scale.
The function has now been activated. The  symbol will appear on the cooking zone.

Deactivating

1. Select the cooking zone.
2. Set the power setting to 0 on the control panel.
The cooking zone will switch itself off. The  symbol will go out and the residual heat indicator will appear. The function is now deactivated.

Transferring settings

You can use this function to transfer the cooking mode, the power setting and the programmed cooking time from one cooking zone to another.

To transfer the settings, move the cookware from the cooking zone which is switched on to another cooking zone.

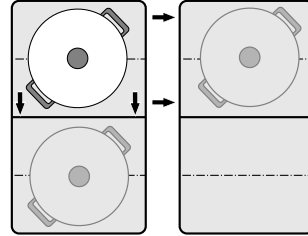

Note: You can find additional information on the positioning of the cookware in the section on → "Flex Zone"

Activation

1. Move the cookware from the active cooking zone to a different one.
The cookware is detected. After a short delay, the display will give you the option to adopt the present settings for the new cooking zone.
2. Confirm adoption of the settings.

The settings are transferred to the new cooking zone. The initial cooking zone is deactivated.

Notes

- Move the cookware to a cooking zone that is not switched on, that you have not yet preset or on which no other cookware has been placed previously.
- The settings for the Move and frying sensor functions cannot be transferred to a different cooking zone by doing this.
- If more than one vessel is moved, the function will only be ready for the vessel that was moved last.
- Place the cookware back on the previous cooking zone while the request to transfer the settings is being processed, so that you can continue cooking with the previous settings. No confirmation is required for this.

Cooking assist functions

The cooking assistance functions guarantee easy cooking and promise outstanding cooking results. The recommended temperature settings are suitable for any type of cooking.

They enable you to cook without using excessive heat and promise the perfect cooking and frying results.

The sensors measure the temperature of the cooking vessel throughout the cooking process. This permits the appliance's output to be regulated in order to maintain the correct temperature.

Once the selected temperature has been reached, the food can be added. The temperature is automatically kept constant without the temperature setting having to be changed.

The cooking zones that have a frying sensor are marked with the frying sensor symbol.

The cooking functions are available to all cooking zones if a wireless temperature sensor is connected.













In this section, you will find information on:

- Cooking assistance functions
- Suitable cookware
- Sensors and special accessories
- Functions and power settings
- Recommended dishes
- Preparing and maintaining the wireless temperature sensor

Cooking assistant function types

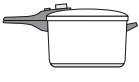
You can use the cooking assistance functions to select the best cooking type for each kind of food.

The table shows the various different settings that are available for the cooking assistant functions:

Cooking assistance functions	Temperature settings	Cookware	Availability	Activate
Frying sensor				
Roasting/frying with a small amount of oil	1, 2, 3, 4, 5			
Cooking functions				
Heating/keeping warm	1 / 70 °C		All hotplates	
Poaching	2 / 90 °C		All hotplates	
Cooking	3 / 100 °C		All hotplates	
Cooking in a pressure cooker	4 / 120 °C		All hotplates	
Frying with a large amount of oil in the saucepan*	5 / 170 °C		All hotplates	

*Preheat with the lid on and fry with the lid off.

If the hob does not have a wireless temperature sensor, this can be purchased from specialist retailers or through our technical after-sales service.

Suitable cookware

Select the cooking zone with the diameter that most closely matches that of the base of the cookware and place the cookware in the centre of this cooking zone.

The cooking functions are not suitable for frying food in a frying pan like you can with the frying sensor.

There are frying pans that are perfect for using with the frying sensor. These can be purchased from specialist retailers or through our technical after-sales service. Always quote the relevant reference number:

- HEZ390210 15 cm frying pan.
- HEZ390220 19 cm frying pan.
- HEZ390230 21 cm frying pan.
- HEZ390250 28 cm frying pan.

These frying pans have a non-stick coating so that you can fry food with only a small amount of oil.

Notes

- The frying sensor has been configured specifically for this type and size of frying pan.
- Other frying pans may overheat and reach a temperature above or below the selected temperature setting. Try the lowest heat setting to begin with and change it if necessary.

Any cookware that is suitable for induction cooking can be used with the cooking functions. You can find information on which types of cookware can be used with an induction hob in the section entitled → "Induction cooking".

The cooking assistance functions table shows which cookware is suitable for which functions.

Sensors and special accessories

The sensors measure the heat of the cooking vessel throughout the cooking process. This ensures that the cooking power is controlled with high precision to maintain the right temperature and achieve optimum cooking results.

Your hob has two different temperature measuring systems for achieving the best results:

- Temperature sensors that are located inside the hob and monitor the temperature of the base of the cookware. Suitable for the frying sensor.
- A wireless temperature sensor that transmits the temperature of the cookware to the control panel. Suitable for the cooking functions.

The temperature sensor is essential for using the cooking functions.

If your hob does not have a wireless temperature sensor, this can be purchased from specialist retailers or through our technical after-sales service by quoting the reference number HZ39050.

You can find more information about the temperature sensor in the section on → *"Preparing and maintaining the wireless temperature sensor"*

Temperature settings

Temperature setting		Suitable for	
1	I	Very low	Preparing and reducing sauces, sweating vegetables and frying food in extra virgin olive oil, butter or margarine.
2	II	Low	Frying food using extra virgin olive oil, butter or margarine, e.g. omelettes.
3	III	Medium - Low	Frying fish and thick food such as meatballs and sausages.
4	IV	Medium - High	Frying steaks, medium or well-done, breaded frozen products and thin foods, e.g. schnitzel, meat in thin slices and vegetables.
5	V	High	Frying food at high temperatures, e.g. steaks (rare), potato fritters and fried potatoes.

Setting procedure

Select the appropriate temperature setting from the table. Place the empty frying pan on the cooking zone.

1. Select the cooking zone. Select the frying sensor cooking mode from the cooking mode menu.
2. Select the required temperature setting.
This activates the function.
The progress bar fills up with red until the frying temperature has been reached. An audible signal sounds once the frying temperature has been reached.
3. Once the frying temperature has been reached, add the fat and then the food to the pan.

Note: Turn the food so that it does not burn.

Switching off the frying sensor

Select a cooking zone and set the power setting to 0 on the control panel. The cooking zone will switch itself off and the residual heat indicator will appear.

Functions and heat settings

Frying sensor

You can use the frying sensor when pan-frying food with a small amount of oil.

Benefits

- The cooking zone continues to heat only for as long as it needs to. This saves energy and prevents oil and fat from being overheated.
- An audible signal will sound once the empty frying pan has reached the optimum temperature for adding oil and food.

Notes

- Do not put the lid on the frying pan as this will prevent the controller from working. You can use a splatter guard to prevent the oil from spitting.
- Use oil or fat that is suitable for frying. If using butter, margarine, cold-pressed olive oil or lard, use temperature setting 1 or 2.
- Never leave a frying pan unattended during heating, regardless of whether or not it contains food.
- If the cooking zone is a higher temperature than the cookware or vice versa, the temperature sensor will not be activated correctly.
- Always use the cooking functions when frying with a large amount of oil in the saucepan. For frying with a large amount of oil in the saucepan, use heat setting 5.

Cooking functions

You can use these functions to heat, simmer or cook food, or cook it in a pressure cooker or fry it in a saucepan with sufficient oil at a controlled temperature.

These cooking functions are available for all cooking zones.

Benefits

- The cooking zone only continues heating for as long as this is necessary to maintain the temperature. This saves energy and prevents the oil or fat from being overheated.
The temperature is continuously monitored. This prevents the food from boiling over the edge of the cookware. In addition, the temperature setting does not need to be changed.

Temperature ranges and settings

Cooking functions	Temperature setting	Temperature range	Suitable for
Heating, keeping warm	1/70 °C	60 - 70 °C	E.g. soups, punch
Poaching	2/90 °C	80 - 90 °C	E.g. rice, milk
Cooking	3/100 °C	90 - 100 °C	E.g. pasta, vegetables
Cooking in a pressure cooker	4/120 °C	110 - 120 °C	E.g. chicken, stew.
Frying with a large amount of oil in the saucepan	5/170 °C	170 - 180 °C	E.g. doughnuts, meatballs

Tips for cooking with the cooking functions

- Heating/keep-warm function: Frozen products in portions, e.g. spinach. Place the frozen product in the cookware. Add the quantity of water specified by the manufacturer. Cover the cookware and select the 1/70 °C setting. Stir during cooking.
- Simmering: Thicken food, e.g. sauces. Bring the food to the boil at the recommended temperature. Once the food has thickened, simmer at setting 2/90 °C.
When the signal sounds, keep the food warm at this setting for the required time.
- Boiling: Heat up water with the lid on. It will not boil over. Select temperature setting 3/100 °C.
- Cooking in a pressure cooker function: Follow the manufacturer's recommendations. Continue cooking for the recommended time once the signal has sounded. Select temperature setting 4/120 °C.
- Frying with a large amount of oil in the saucepan function: Heat the oil with the lid on. Once the signal has sounded, take the lid off and add the food. Select temperature setting 5/170 °C.

Notes

- Always cook with the lid on. Exception: "Frying with a large amount of oil in the saucepan", temperature setting 5/170 °C.
- If an audible signal does not sound, make sure that the lid is on the pan.

- The cooking functions inform you when the water or oil has reached the optimal temperature for adding the food (see the table for exceptions where food should be added right at the beginning).

Notes

- The amount of food in the cookware must be sufficient to cover the silicone patch of the temperature sensor.
- Always use the frying sensor when frying with a small amount of oil.
- Always position the cookware such that the temperature sensor is not facing another item of cookware.
- The temperature sensor may not be removed from the cookware during the cooking process. Once the cooking process has ended, the functions can be selected for another cooking zone.
- Remove the temperature sensor once you have finished cooking. Caution: The temperature sensor may be very hot.

- Never leave oil unattended during heating. Use oil or fat that is suitable for frying. Do not mix different cooking fats together, e.g. oil and lard. Mixtures of different fats may froth up when hot.
- If you are not satisfied with the cooking result, e.g. when cooking potatoes, next time use less water but keep the recommended temperature setting.

Setting the boiling point

The point at which water starts to boil depends on the height of your home above sea level. You can set the boiling point if water is boiling too strongly or not strongly enough. To do this, proceed as follows:

- Select the cooking function basic setting; see the section entitled → "Basic settings"
- The basic setting is set to 200 - 400 m by default. If your home is at an elevation of between 200 and 400 m above sea level, you do not need to set the boiling point; outside of this range, you will need to select the setting that corresponds to the elevation of your home above sea level.

Note: Temperature setting 3/100 °C allows for efficient cooking even if the water does not boil very strongly during the heating process. However, if you are not satisfied with the boiling result, you can change the boiling point setting.

Connecting the wireless temperature sensor to the control panel

You will need to connect the wireless temperature sensor to the control panel before using the cooking functions for the first time.

1. Open the basic settings and select "Cooking sensor" from the menu.
2. Select the "Add new cooking sensor" option. Press the  symbol on the wireless temperature sensor within 30 seconds. After a few seconds, the status of the connection between the temperature sensor and the control panel appears in the display.

The cooking functions are made available once the temperature sensor has been connected to the control panel correctly.

Notes

- If there is a fault with the temperature sensor, the connection may not be established correctly for the following reasons:
 - Bluetooth communication error.
 - You did not press the symbol on the temperature sensor within 30 seconds of selecting a hotplate.
 - The battery in the temperature sensor has run out.
 Reset the temperature sensor and follow the connection procedure once again.
- If the temperature sensor and the control panel are not connected correctly due to a transmission error, follow the connection procedure once again. If the display continues to indicate an incorrect connection, contact our technical after-sales service.

Resetting the wireless temperature sensor

1. Touch and hold the  symbol for approximately 8-10 seconds. While you are doing this, the temperature sensor's LED indicator will light up three times. When the LED lights up for the third time, it will start to reset the temperature sensor. At this point, you will need to lift your finger off the symbol. Once the LED goes out, this means that the wireless temperature sensor has been reset.
2. Repeat the connection procedure from point 2.

Setting procedure

1. Attach the temperature sensor to the saucepan; see the section on → "Preparing and maintaining the wireless temperature sensor"
2. Place a saucepan filled with sufficient liquid on the required hotplate and always put the lid on.
3. Select the cooking zone on which you have placed the cookware with the temperature sensor. In the cooking zone's cooking mode menu, select the cooking functions cooking mode.
4. Touch the  symbol for the wireless temperature sensor.
5. Select the right temperature setting from the table. The function has now been activated. The progress bar fills up with red until the water or oil has reached the appropriate temperature so that you can add the food. An audible signal sounds once the temperature has been reached.
6. Once the signal has sounded, take the lid off and add the food. Keep the lid on during cooking.

Note: Do not cover the pan when using the "Frying with a large amount of oil in the saucepan" function.

Switching off cooking functions

Select a cooking zone and set the power setting to 0 on the control panel. The cooking zone will switch itself off and the residual heat indicator will appear.

Recommended dishes

The following table shows a selection of dishes and is arranged by food type. The temperature and the cooking time depend on the amount, the condition and the quality of the food.

Meat	Cooking assistance functions	Temperature setting	Total cooking time from signal tone (min.)
Function for frying with a small amount of oil			
Schnitzel*	Frying sensor	4	6-10
Schnitzel, breaded*	Frying sensor	4	6-10
Fillet**	Frying sensor	4	6-10
Chops*	Frying sensor	3	10-15
Cordon bleu*	Frying sensor	4	10-15
Wiener schnitzel*	Frying sensor	4	10-15
Steak, rare**	Frying sensor	5	6-8
Steak, medium**	Frying sensor	5	8-12
Steak, well done*	Frying sensor	4	8-12
Poultry breast*	Frying sensor	3	10-20
Meat loaf	Frying sensor	2	6-9
Strips of sautéed meat***	Frying sensor	4	7-12
Gyros***	Frying sensor	4	7-12
Bacon*	Frying sensor	2	5-8
Minced meat***	Frying sensor	4	6-10
Hamburger*	Frying sensor	3	6-15
Meatballs*	Frying sensor	3	6-15
Stuffed meatballs*	Frying sensor	3	10-20
Blanched sausages*	Frying sensor	3	8-20
Raw sausages*	Frying sensor	3	8-20
Poaching function			
Frankfurters****	Cooking functions	2 / 90 °C	10-20
Cooking function			
Meatballs****	Cooking functions	3 / 100 °C	20-30
Stewing poultry****	Cooking functions	3 / 100 °C	60-90
Viennese boiled beef****	Cooking functions	3 / 100 °C	60-90
Function for cooking in a pressure cooker			
Chicken*****	Cooking functions	4 / 120 °C	15-25
Beef*****	Cooking functions	4 / 120 °C	15-25
Function for frying with a large amount of oil			
Chicken portions*****	Cooking functions	5 / 170 °C	10-15
Meatballs*****	Cooking functions	5 / 170 °C	10-15

* Turn several times.

** Add the oil and food to the frying pan after the signal sounds.

*** Stir regularly.

**** Heat and cook with the lid on. Add the food after the signal sounds.

***** Add the food right at the beginning.

***** Heat the oil with the lid on. Fry in portions with the lid off.

Fish	Cooking assistance functions	Temperature setting	Total cooking time from signal tone (min.)
Function for frying with a small amount of oil			
Fish fillet, unbreaded*	Frying sensor	4	10-20
Fish fillet, breaded*	Frying sensor	3	10-20
Prawns*	Frying sensor	4	4-8
Shrimps*	Frying sensor	4	4-8
Whole fish*	Frying sensor	3	10-20
Poaching function			
Stewing fish**	Cooking functions	2 / 90 °C	15-20
Function for frying with a large amount of oil			
Fish, beer-battered***	Cooking functions	5 / 170 °C	10-15
Fish, breaded***	Cooking functions	5 / 170 °C	10-15

* Turn several times.

** Heat and cook with the lid on. Add the food after the signal sounds.

*** Heat the oil with the lid on. Fry in portions with the lid off.

Egg dishes	Cooking assistance functions	Temperature setting	Total cooking time from signal tone (min.)
Function for frying with a small amount of oil			
Fried eggs in butter*	Frying sensor	2	2-6
Fried eggs in oil**	Frying sensor	4	2-6
Scrambled egg***	Frying sensor	2	4-9
Omelette****	Frying sensor	2	3-6
Pancakes****	Frying sensor	5	1.5- 2.5
French toast****	Frying sensor	3	4-8
Raisin pancake****	Frying sensor	3	10-15
Cooking function			
Boiling eggs*****	Cooking functions	3 / 100 °C	5-10

* Add the butter and food to the frying pan after the signal sounds.

** Add the oil and food to the frying pan after the signal sounds.

*** Stir regularly.

**** Heat the oil with the lid on. Fry in portions with the lid off (the table shows the total cooking time for each portion).

***** Add the food right at the beginning.

Vegetables and pulses	Cooking assistance functions	Temperature setting	Total cooking time from signal tone (min.)
Function for frying with a small amount of oil			
Garlic*	Frying sensor	2	2-10
Onions*	Frying sensor	2	2-10
Courgettes**	Frying sensor	3	4-12
Aubergines**	Frying sensor	3	4-12
Pepper*	Frying sensor	3	4-15
Mushrooms*	Frying sensor	4	10-15
Frying green asparagus**	Frying sensor	3	4-15
Braising vegetables in oil*	Frying sensor	1	10-20
Glazing vegetables*	Frying sensor	3	6-10
Cooking function			
Boiling broccoli***	Cooking functions	3 / 100 °C	10-20
Boiling cauliflower***	Cooking functions	3 / 100 °C	10-20
Boiling cabbage***	Cooking functions	3 / 100 °C	30-40
Boiling green beans***	Cooking functions	3 / 100 °C	15-30
Chickpeas****	Cooking functions	3 / 100 °C	60-90
Peas***	Cooking functions	3 / 100 °C	15-20
Lentils****	Cooking functions	3 / 100 °C	45-60
Function for cooking in a pressure cooker			
Vegetables in a pressure cooker****	Cooking functions	4 / 120 °C	3-6
Chickpeas in a pressure cooker****	Cooking functions	4 / 120 °C	25-35
Beans in a pressure cooker****	Cooking functions	4 / 120 °C	25-35
Lentils in a pressure cooker****	Cooking functions	4 / 120 °C	10-20
Function for frying with a large amount of oil			
Deep-fat frying breaded vegetables*****	Cooking functions	5 / 170 °C	4-8
Deep-fat frying vegetables in beer batter*****	Cooking functions	5 / 170 °C	4-8
Deep-fat frying breaded mushrooms*****	Cooking functions	5 / 170 °C	4-8
Deep-fat frying mushrooms in beer batter*****	Cooking functions	5 / 170 °C	4-8

* Stir regularly.

** Turn several times.

*** Heat and cook with the lid on. Add the food after the signal sounds.

**** Add the food right at the beginning.

***** Heat the oil with the lid on. Fry in portions with the lid off.

Potatoes	Cooking assistance functions	Temperature setting	Total cooking time from signal tone (min.)
Function for frying with a small amount of oil			
Fried potatoes (made from unpeeled boiled potatoes)*	Frying sensor	5	6-12
Fried potatoes (made from raw potatoes)*	Frying sensor	4	15-25
Potato fritter**	Frying sensor	5	2.5-3.5
Swiss rösti***	Frying sensor	1	50-55
Glazed potatoes*	Frying sensor	3	15-20
Poaching function			
Potato dumplings****	Cooking functions	2 / 90 °C	30-40
Cooking function			
Boiling potatoes*****	Cooking functions	3 / 100 °C	30-45
Function for cooking in a pressure cooker			
Potatoes in a pressure cooker*****	Cooking functions	4 / 120 °C	10-20

* Stir regularly.
 ** Total cooking time per portion. Fry one after the other.
 ** Add the butter and food to the frying pan after the signal sounds.
 **** Heat and cook with the lid on. Add the food after the signal sounds.
 ***** Add the food right at the beginning.

Pasta and cereals	Cooking assistance functions	Temperature setting	Total cooking time from signal tone (mins)
"Poaching" function			
Rice*	Cooking functions	2 / 90 °C	25 - 35
Polenta**	Cooking functions	2 / 90 °C	3 - 8
Semolina pudding**	Cooking functions	2 / 90 °C	5 - 10
"Boiling" function			
Pasta**	Cooking functions	3 / 100 °C	7 - 10
Stuffed pasta**	Cooking functions	3 / 100 °C	6 - 15
"Boiling in a pressure cooker" function			
Rice in a pressure cooker***	Cooking functions	4 / 120 °C	6 - 8

* Heat and cook with the lid on. Add the food after heating.
 ** Stir regularly.
 *** Add the food right at the beginning.

Soups	Cooking assistance functions	Temperature setting	Total cooking time from signal tone (mins)
"Poaching" function			
Creamy soups*	Cooking functions	2 / 90 °C	10 - 15
"Boiling" function			
Broth**	Cooking functions	3 / 100 °C	60 - 90
Instant soups*	Cooking functions	3 / 100 °C	5 - 10
"Boiling in a pressure cooker" function			
Broth in a pressure cooker**	Cooking functions	4 / 120 °C	20 - 30

* Stir regularly.
 ** Add the food right at the beginning.

Sauces ¹	Cooking assistance functions	Temperature setting	Total cooking time from signal tone (mins)
"Frying with a small amount of oil" function			
Tomato sauce with vegetables*	Frying sensor	1	25 - 35
Béchamel sauce*	Frying sensor	1	10 - 20
Cheese sauce*	Frying sensor	1	10 - 20
Reducing sauces*	Frying sensor	1	25 - 35
Sweet sauces*	Frying sensor	1	15 - 25
* Stir regularly			

Desserts	Cooking assistance functions	Temperature setting	Total cooking time from signal tone (min.)
Poaching function			
Rice pudding*	Cooking functions	2 / 90 °C	40-50
Porridge*	Cooking functions	2 / 90 °C	10-15
Compote**	Cooking functions	3 / 100 °C	15-25
Chocolate pudding*	Cooking functions	2 / 90 °C	3-5
Function for frying with a large amount of oil			
Deep-fat frying jam-filled doughnuts***	Cooking functions	5 / 170 °C	5-10
Deep-fat frying ring doughnuts***	Cooking functions	5 / 170 °C	5-10
Deep-fat frying buñuelos***	Cooking functions	5 / 170 °C	5-10
* Stir regularly.			
** Add the food right at the beginning.			
*** Heat the oil with the lid on. Fry in portions with the lid off.			

Frozen products	Cooking assistance functions	Temperature setting	Total cooking time from signal tone (min.)
Function for frying with a small amount of oil			
Schnitzel*	Frying sensor	4	15-20
Cordon bleu*	Frying sensor	4	10-30
Poultry breast*	Frying sensor	4	10-30
Chicken nuggets*	Frying sensor	4	10-15
Gyros**	Frying sensor	3	10-15
Kebab**	Frying sensor	3	10-15
Fish fillet, unbreaded*	Frying sensor	3	10-20
Fish fillet, breaded*	Frying sensor	3	10-20
Fish fingers*	Frying sensor	4	8-12
Frying chips**	Frying sensor	5	4-6
Stir fries**	Frying sensor	3	6-10
Spring rolls*	Frying sensor	4	10-30
Camembert*	Frying sensor	3	10-15
Heating/keep-warm function			
Vegetables in cream sauce**	Cooking functions	1 / 70 °C	15-20
* Turn several times.			
** Stir regularly.			
*** Add the food after the signal sounds.			
**** Heat the oil with the lid on. Fry in portions with the lid off.			

Frozen products	Cooking assistance functions	Temperature setting	Total cooking time from signal tone (min.)
Cooking function Green beans***	Cooking functions	3 / 100 °C	15-30
Function for frying with a large amount of oil Deep-fat frying chips****	Cooking functions	5 / 170 °C	4-8
* Turn several times. ** Stir regularly. *** Add the food after the signal sounds. **** Heat the oil with the lid on. Fry in portions with the lid off.			

Further	Cooking assistance functions	Temperature setting	Total cooking time from signal tone (min.)
Function for frying with a small amount of oil Frying camembert* Croutons** Dried ready meals*** Toasting almonds**** Toasting nuts**** Toasting pine nuts****	Frying sensor Frying sensor Frying sensor Frying sensor Frying sensor Frying sensor	3 3 1 4 4 4	7-10 6-10 5-10 3-15 3-15 3-15
Heating/keep-warm function Heating goulash soup**** Heating mulled wine****	Cooking functions Cooking functions	1 / 70 °C 1 / 70 °C	10-20 -
Poaching function Heating milk****	Cooking functions	2 / 90 °C	3-10
* Turn several times. ** Stir regularly. *** Add the water after the signal sounds. Add the food once the water has boiled. **** Add the food to the frying pan after the signal sounds. ***** Add the food right at the beginning.			

Dishes

This function can be used to cook a wide variety of food. The appliance will choose the optimal setting for you.

Selecting and setting the programme

1. Select the required cooking zone.
2. Select the "Assist" type of heating on the control panel for the cooking zone.
3. Select the required programme group.
4. Select the required food.

You will be guided through the entire setting procedure for the food you have selected, and will be provided with information on how to cook it.

Cancelling a programme

To cancel a programme, select power setting 0 or change the type of heating.

Preparing and maintaining the wireless temperature sensor

In this section, you will find information on:

- Adhering the silicone patch
- Using the wireless temperature sensor
- Cleaning
- Changing the battery

Optional accessories, such as the silicone patch and temperature sensor, can be purchased from specialist retailers or through our technical after-sales service. Please quote the relevant reference number when doing this:

00577921	Set of 5 silicone patches
HEZ39050	Temperature sensor and set of 5 silicone patches

Adhering the silicone patch

The silicone patch attaches the temperature sensor to the cookware.

A silicone patch must be adhered when using a saucepan with the cooking functions for the first time.

Proceed as follows:

1. The adhesion point on the saucepan must be free of grease. Clean the saucepan, dry it thoroughly and wipe the adhesion point with a degreasing agent such as spirit.
2. Remove the protective film from the silicone patch. Adhere the silicone patch to the saucepan in the correct place using the enclosed template as a guide.

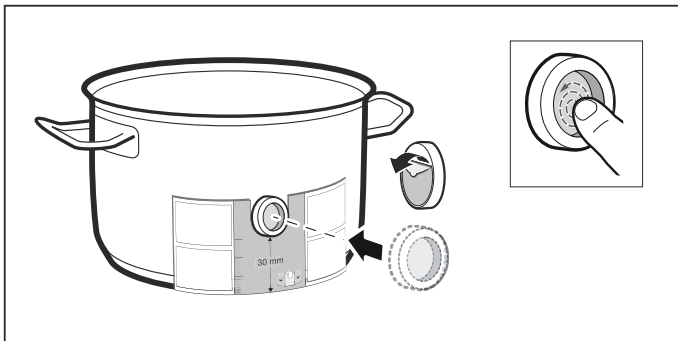

3. Press the silicone patch down, including its inside surface.

The adhesive requires 1 hour to fully harden. The cookware must not be used or cleaned during this time.

Notes

- Cookware with the silicone patch must not be left to soak for long periods in soapy water.
- If the silicone patch comes off, attach a new one.

Using the wireless temperature sensor

Attach the temperature sensor to the silicone patch and align it correctly.

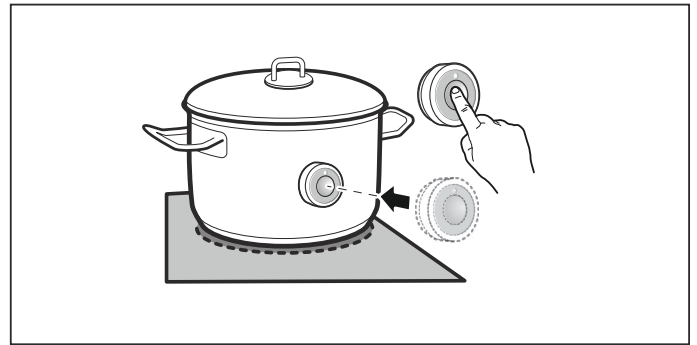

Notes

- Make sure that the silicone patch is completely dry before attaching the temperature sensor.
- Position the cookware in such a way that the temperature sensor is pointing towards the outer side of the hob.
- To prevent overheating, the temperature sensor must not be pointed towards another item of cookware that is hot.
- Remove the temperature sensor from the saucepan after cooking. Store it in a clean, safe place away from sources of heat.
- You can use up to three temperature sensors at the same time.

Cleaning

Do not clean the wireless temperature sensor in the dishwasher.

You can find information on cleaning the temperature sensor in the section on → "Cleaning"

Changing the battery

If you press the wireless temperature sensor symbol and the LED does not light up, the battery is flat.

Changing the battery:

1. Remove the silicone cover from the lower section of the casing. Unscrew the screws with a screwdriver.

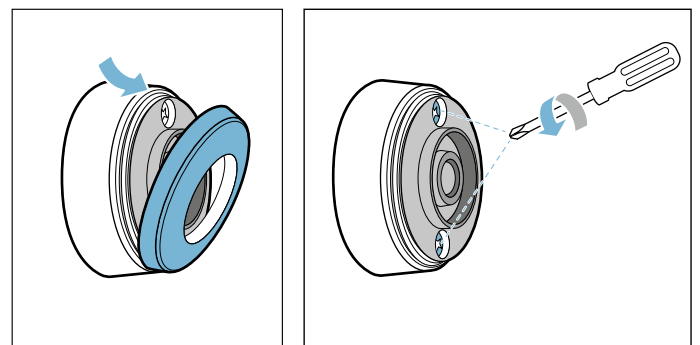

2. Remove the upper section of the casing. Take the old batteries out. Put the new batteries in. Make sure that the polarity is correct.

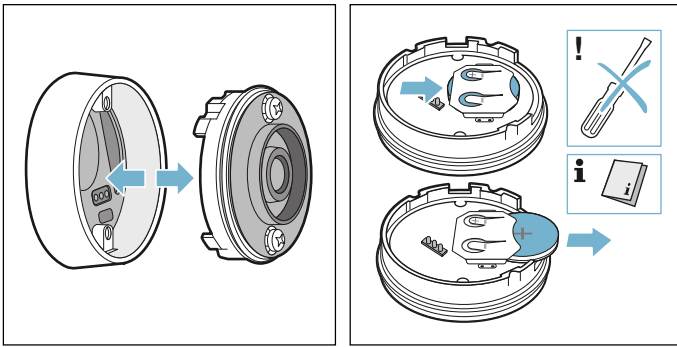

Caution!

Do not use metal objects to remove the battery. Do not touch the contacts.

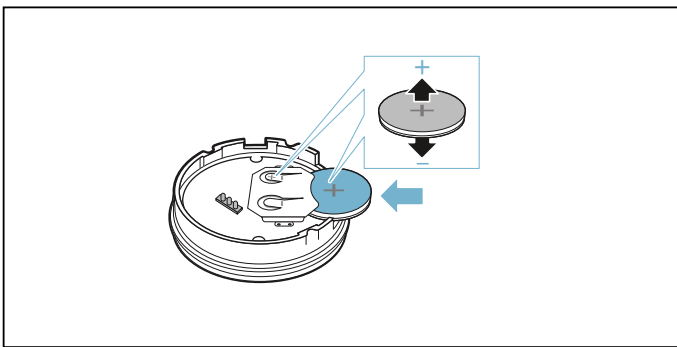

3. Put the upper and lower sections of the casing back together. Make sure that the contact pins are aligned correctly.

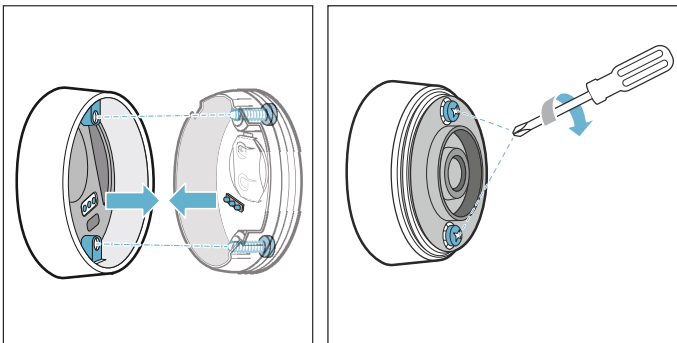

4. Put the silicone cover back on the lower section of the temperature sensor casing.

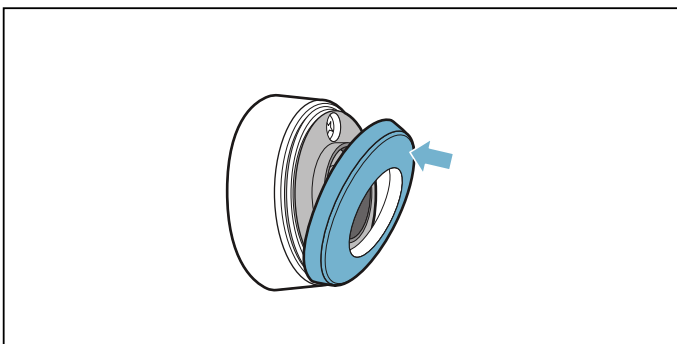

Note: Only use premium-quality CR2032 batteries. These have an especially long service life.

Declaration of Conformity

Robert Bosch Hausgeräte GmbH hereby declares that the appliance with wireless temperature sensor function meets the basic requirements and other relevant provisions of the Directive 1999/5/EG.

A detailed R&TTE Declaration of Conformity can be found online at www.bosch-home.com on the product page for your appliance under "Additional documents".

The logos and the Bluetooth® brand are registered trademarks and property of Bluetooth SIG, Inc. These trademarks are used by Robert Bosch Hausgeräte GmbH under licence. All other trademarks and brand names are owned by the respective companies.

Childproof lock

You can use the childproof lock to prevent children from switching on the hob.

Activating and deactivating the childproof lock



All cooking zones must be switched off.

Activating

1. Switch off all cooking zones.
2. Touch the  touch key and follow the instructions on the display.

This activates the childproof lock. The hob is now locked.

Deactivating

1. Switch on the hob using the main switch .
2. Touch the  touch key and follow the instructions on the display.

This deactivates the childproof lock. The lock is now released.

Childproof lock

With this function, the childproof lock automatically activates when a hob is switched off.

Switching on and off

You can find out how to switch the automatic childproof lock on in the → *"Basic settings"* section

Wipe protection

Wiping over the control panel while the hob is switched on may alter the settings. To avoid doing this, you can use the hob's "Lock control panel for cleaning" function.

Activating

Touch the  touch key.

Wipe protection is now active. The control panel will remain locked for 30 seconds. You can now wipe over the surface without altering any settings.

Deactivating

The control panel will be unlocked automatically after 30 seconds. To cancel the wipe protection function before this time has elapsed, touch the  touch key and follow the instructions on the display.

Notes

- An audible signal will sound 30 seconds after the wipe protection function is activated. This indicates that the function has ended.
- The cleaning lock does not lock the main switch. The hob can be switched off at any time.

Automatic safety cut-out

If a cooking zone operates for an extended period and no settings are changed, the automatic safety switch-off is activated.

This stops the cooking zone from heating up. A notification will appear on the display.

Touching any symbol will switch off the display. The cooking zone can now be reset.

The point at which the automatic safety switch-off becomes active depends on the power setting in use (after 1 to 10 hours).

Basic settings

Your appliance has various default settings. You can adapt these default settings to your own routines and requirements.

Opening the basic settings

Touch the  key on the hob to open the basic settings. To do this, the cooking zones must be switched off.

Navigating through the basic settings

Swipe your finger up or down in the overview to scroll through the various settings. Touch a setting to access further options in its sub-menu.

Touch the < symbol in the top left corner of a sub-menu to return to the overview.

Exiting the basic settings

Touch the X symbol in the top right corner of the overview to exit the basic settings.

Saving or discarding changes

When you exit the basic settings, you will be asked whether you would like to save or discard the changes you have just made. If you choose to save your changes, they will be applied. If you choose to discard the changes you have just made, these changes will be undone.

Setting	Description and options
Language	You can change the language of the appliance.
Signal tones	You can select which signal tones the appliance should sound. <ul style="list-style-type: none"> ■ All signal tones off – the appliance will not sound any signal tones. ■ All signal tones on* – the appliance will sound all signal tones. ■ Only error tones on – the appliance will only sound signal tones if there is an error message.
Signal tone duration	You can change the duration of the signal tones.
Button tone	You can choose whether or not the appliance will sound when fields and symbols are touched on the touchscreen.
Display brightness	You can change the brightness of the display.
flexInduction zone	You can choose whether the Flex areas of the hob will be linked or separate on start-up.
MoveMode settings	The preset Move function settings can be changed as required.
Childproof lock	You can use the childproof lock to lock the hob and prevent children from using it without supervision. <ul style="list-style-type: none"> ■ Manual* – the childproof lock must always be switched on and off manually. ■ Automatic – the childproof lock will be activated automatically every time you switch off the hob.
Brand logo	You can choose whether or not the brand logo will be displayed on start-up.
reStart	You can set how long your appliance saves the most recently used settings after it has been switched off.
Maximum power consumption	You can restrict the hob's total power and adapt it to the local mains connection. Contact your dealer for information on adaptation.
Energy consumption	You can choose whether or not the appliance displays its energy consumption after it has been switched off.
Cooking sensor	You can add a new cooking sensor.
Cooking function	You can enter the elevation of your location above sea level to improve the cooking sensor's accuracy.
Cookware test	You can check whether or not your cookware is suitable for induction cooking.
Appliance information	You can view information about your appliance.
Factory settings	You can reset all settings to what they were on delivery.

*Default setting when delivered

Energy consumption indicator

This function indicates the total amount of energy consumed by this hob the last time it was used for cooking.

Once switched off, the energy consumption in kWh will be displayed for 10 seconds.

You can find out how to switch this function on in the section on → *"Basic settings"*

Cookware check

This function can be used to check the speed and quality of the cooking process depending on the cookware.

The result is a reference value and depends on the properties of the cookware and the cooking zone being used.

1. With the cookware still cold, fill it with approximately 200 ml of water and place it on the centre of the cooking zone with the diameter that most closely matches that of the base of the cookware.
2. Go to the basic settings and select the "Cookware test" menu item.

The function has now been activated.

After 10 seconds, the result for the quality and speed of the cooking process will appear on the display. Touch the relevant cooking zone on the display to view more detailed results of the cookware test.

Notes

- The flexible cooking zone only counts as a single cooking zone; place no more than one item of cookware on it.
- If the diameter of the cooking zone that is used is much smaller than the diameter of the cookware, only the middle of the cookware can be expected to heat up. This may result in the cooking results not being as good as expected or being less than satisfactory.
- You can find information on this function in the section on → *"Basic settings"*.
- You can find information on the type, size and positioning of the cookware in the sections on → *"Induction cooking"* and → *"Flex Zone"*.

Cleaning

Suitable maintenance and cleaning products can be purchased from the after-sales service or in our e-Shop.

Hob

Cleaning

Always clean the hob after cooking. This will prevent food deposits from becoming burned on. Only clean the hob after the residual heat indicator has gone out.

Clean the hob with a damp dish cloth and dry it with a cloth or towel to prevent limescale build-up.

Only use cleaning agents that are suitable for this type of hob. Observe the manufacturer's instructions on the product packaging.

Never use:

- Undiluted washing-up liquid
- Cleaning agents designed for dishwashers
- Abrasive cleaners
- Harsh cleaning agents, such as oven spray and limescale remover
- Scouring pads
- High-pressure cleaners or steam jet cleaners

Stubborn dirt is best removed with a glass scraper, available from retailers. Observe the manufacturer's instructions.

You can obtain a suitable glass scraper from customer services or through our online shop.

Using a special sponge for cleaning glass-ceramic hobs achieves a great cleaning result.

Potential marks	
Limescale and water marks	Clean the hob as soon as it has cooled down. You can use a cleaning agent suitable for glass-ceramic hobs.*
Sugar, rice starch or plastic	Clean immediately. Use a glass scraper. Caution: Risk of burns.*
* Then clean with a damp dish cloth and dry with a cloth or towel.	

Note: Do not use any cleaning agents while the hob is still hot. This may mark the surface. Make sure that any residue left by cleaning agents is removed.

Hob surround

To prevent damage to the hob surround, observe the following instructions:

- Only use warm soapy water
- Wash new dish cloths thoroughly before use.
- Do not use harsh or abrasive cleaning agents.
- Do not use a glass scraper or sharp objects.

Wireless temperature sensor

Temperature sensor

Clean the temperature sensor with a damp cloth. Never clean it in the dishwasher. Do not immerse it in water or clean it under running water.

Remove the temperature sensor from the saucepan after cooking. Store it in a clean, safe place (such as in its packaging) away from sources of heat.

Silicone patch

Clean and dry before attaching to the temperature sensor. Dishwasher safe.

Note: Cookware with the silicone patch must not be left to soak for long periods in soapy water.

Temperature sensor window

The sensor window must always be clean and dry. Proceed as follows:

- Remove dirt and oil splatters regularly.
- Use a soft cloth or cotton buds and window cleaner for cleaning.

Notes

- Do not use abrasive cleaning agents such as scouring pads, scrubbing brushes or cream cleaners.
- Do not touch the sensor window with your fingers. This may make it dirty or scratch it.

Frequently Asked Questions (FAQ)

Using the appliance

Why can't I switch on the hob and why is the childproof lock symbol lit?

The childproof lock is activated.
You can find information on this function in the section on → "*Childproof lock*"

Why are the displays flashing and why can I hear an audible signal?

Remove any liquid or food remains from the control panel. Remove any objects from the control panel.
You can find instructions on how to deactivate the audible signal in the section on → "*Basic settings*"

Noise

Why I can hear noises while I'm cooking?

Noises may be generated while using the hob depending on the base material of the cookware. These noises are a normal part of induction technology. They do not indicate a defect.

Possible noises:

A low humming noise like the one a transformer makes:

Occurs when cooking on a high power setting. The noise disappears or becomes quieter when the power setting is reduced.

Low whistling noise:

Occurs when the cookware is empty. This noise disappears when water or food is added to the cookware.

Crackling:

Occurs when using cookware made from different layers of material or when using cookware of different sizes and different materials at the same time. The loudness of the noise may vary depending on the quantity of food being cooked and the cooking method.

High-pitched whistling noises:

May occur when two cooking zones are used at the highest power setting at the same time. The whistling noises disappear or become quieter when the power setting is reduced.

Fan noise:

The hob is equipped with a fan that switches on automatically at high temperatures. The fan may continue to run even after you have switched off the hob if the temperature detected is still too high.

Cookware

Which types of cookware can be used with the induction hob?

You can find information on which types of cookware can be used with an induction hob in the section on → "*Induction cooking*".

Why is the cooking zone not heating up and the power setting flashing?

The cooking zone on which the cookware has been placed is not switched on.
Check that you have switched on the correct cooking zone.

The cookware is too small for the cooking zone that is switched on or it is not suitable for induction cooking.
Check that the cookware is suitable for induction cooking and that it is placed on the cooking zone that best corresponds to its size. You can find information on the type, size and positioning of cookware in the sections on → "*Induction cooking*", → "*Flex Zone*" and → "*Move function*".

Why is it taking so long for the cookware to heat up or why is it not heating up sufficiently despite being on a high power setting?

The cookware is too small for the cooking zone that is switched on or it is not suitable for induction cooking.
Check that the cookware is suitable for induction cooking and that it is placed on the cooking zone that best corresponds to its size. You can find information on the type, size and positioning of cookware in the sections on → "*Induction cooking*", → "*Flex Zone*" and → "*Move function*".

Cleaning

How do I clean the hob?

Using a special glass-ceramic cleaning agent produces the best results. We advise against using harsh or abrasive cleaning agents, dishwasher detergent (concentrated) or scouring pads.

You can find more information on cleaning and caring for your hob in the section on → "Cleaning"

? Trouble shooting

Faults often have simple explanations. Please read the information and tips provided below before calling the after-sales service.

Information, warnings and fault messages

In the event of a problem, information, warnings or fault messages will automatically appear on the display. Follow the instructions on the touchscreen to rectify the problem.

Note: . A fault code will be displayed with some warnings. If a fault code is displayed, quote it when contacting the after-sales service.

Tips

Problem	Remedial action
The hob will not switch on.	Use other electrical appliances to check whether a short circuit has occurred in the power supply. Make sure that the appliance has been connected in accordance with the circuit diagram. If the fault cannot be rectified, inform the technical after-sales service.
The cooking zone's power setting cannot be increased.	The hob's total power output has been limited. Alter the total power under "Maximum power consumption" in the basic settings. If a very large item of cookware is being used, this may have an effect on the maximum power setting for that half of the hob. Rearrange the cookware on the hob.
The PowerBoost function has been deactivated or cannot be activated.	The hob's total power output has been limited. Alter the total power under "Maximum power consumption" in the basic settings.
An audible signal sounds when there is an object on the touchscreen.	Remove the object and acknowledge the message on the display. You will now be able to turn the hob back on. Do not place hot cookware on the control panel.
The cookware is not being detected.	The cookware may not be suitable for induction cooking.
The hob reacts unusually or cannot be operated properly.	Switch off the appliance using either the household fuse or the circuit breaker in the fuse box. Wait a few seconds and switch it back on.
"E" will be shown on the display.	Select the cooking zone to read the fault code.

Demo mode

If the  symbol is shown on the display, demo mode is active. The appliance does not heat up in demo mode. Disconnect the appliance from the power supply. Wait a few seconds before reconnecting the appliance. Then deactivate demo mode in the basic settings within 3 minutes of switching on the appliance.

Customer service

Our after-sales service is there for you if your appliance needs to be repaired. We will always find an appropriate solution, also in order to avoid after-sales personnel having to make unnecessary visits.

E number and FD number

Please quote the E number (product number) and FD number (production number) of your appliance when contacting the after-sales service.

The rating plate bearing these numbers can be found:

- On the appliance certificate.
- On the underside of the hob.

The E number can also be found on the hob's glass ceramic surface. You can check the E number, after-sales service index (KI) and FD number by going to the basic settings. Refer to the section entitled → "*Basic settings*" to find out how to do this.

Please note that a visit from an after-sales service engineer is not free of charge in the event that the appliance has been misused, even during the warranty period.

Please find the contact data of all countries in the enclosed customer service list.

To book an engineer visit and product advice

- GB** 0344 892 8979
Calls charged at local or mobile rate.
- IE** 01450 2655
0.03 € per minute at peak. Off peak 0.0088 € per minute.

Rely on the professionalism of the manufacturer. You can therefore be sure that the repair is carried out by trained service technicians who carry original spare parts for your appliances.

Test dishes

This table has been produced for test institutes to facilitate the testing of our appliances.

The data in the table refers to our Schulte-Ufer cookware accessories (4 piece cookware set for the HEZ 390042 induction hob) with the following measurements:

- Saucepan Ø 16 cm, 1.2 l for hotplates of Ø 14.5 cm
- Pot Ø 16 cm, 1.7 l for hotplates of Ø 14.5 cm
- Pot Ø 22 cm, 4.2 l for hotplates of Ø 18 cm
- Frying pan Ø 24 cm, for hotplates of Ø 18 cm

Test dishes	Cookware	Heat setting	Preheating		Cooking	
			Cooking time (min:sec)	Lid	Heat setting	Lid
Melting chocolate Chocolate coating (e.g. Dr. Oetker brand, dark chocolate 55% cocoa, 150 g)	Saucepan, 16 cm diameter	-	-	-	1.5	No
Heating and keeping lentil stew warm Lentil stew* Initial temperature 20 °C						
Amount: 450 g	Cooking pot, 16 cm diameter	9	1:30 (without stirring)	Yes	1.5	Yes
Amount: 800 g	Saucepan, 22 cm diameter	9	2:30 (without stirring)	Yes	1.5	Yes
Lentil stew from a tin E.g lentils with Erasco sausages. Initial temperature 20 °C						
Amount: 500 g	Cooking pot, 16 cm diameter	9	Approx. 1:30 (stir after approx. 1 minute)	Yes	1.5	Yes
Amount: 1 kg	Saucepan, 22 cm diameter	9	Approx. 2:30 (stir after approx. 1 minute)	Yes	1.5	Yes
Preparing Béchamel sauce Temperature of the milk: 7 °C Ingredients: 40 g butter, 40 g flour, 0.5 l milk (3.5% fat content) and a pinch of salt						
1. Melt the butter, stir in the flour and salt, and heat up the mixture.	Saucepan, 16 cm diameter	2	Approx. 6:00	No	-	-
2 Add the milk to the roux and bring to the boil, stirring continuously.		7	Approx. 6:30	No	-	-
3. Once the Béchamel sauce comes to the boil, leave it on the hotplate for a further two minutes, stirring continuously.		-	-	-	2	No

*Recipe in accordance with DIN 44550

**Recipe in accordance with DIN EN 60350-2

Test dishes	Cookware	Heat setting	Preheating		Cooking	
			Cooking time (min:sec)	Lid	Heat setting	Lid
Cooking rice pudding						
Rice pudding, cooked with the lid on Temperature of the milk: 7 °C Heat the milk until it starts to rise up. Set the recommended heat setting and add rice, sugar and salt to the milk. The cooking time, including preheating, is approx. 45 minutes.						
Ingredients: 190 g short-grain rice, 90 g sugar, 750 ml milk (3.5% fat content) and 1 g salt	Cooking pot, 16 cm diameter	8.5	Approx. 5:30	No	3 (stir after 10 minutes)	Yes
Ingredients: 250 g short-grain rice, 120 g sugar, 1 l milk (3.5% fat content) and 1.5 g salt	Saucepan, 22 cm diameter	8.5	Approx. 5:30	No	3 (stir after 10 minutes)	Yes
Rice pudding, cooked without lid Temperature of the milk: 7 °C Add the ingredients to the milk and heat the mixture up while stirring continuously. Once the milk has reached approx. 90 °C, select the recommended heat setting and leave it to simmer on a low heat for approx. 50 minutes.						
Ingredients: 190 g short-grain rice, 90 g sugar, 750 ml milk (3.5% fat content) and 1 g salt	Cooking pot, 16 cm diameter	8.5	Approx. 5:30	No	3	No
Ingredients: 250 g short-grain rice, 120 g sugar, 1 l milk (3.5% fat content) and 1.5 g salt	Saucepan, 22 cm diameter	8.5	Approx. 5:30	No	2.5	No
Cooking rice*						
Water temperature: 20 °C						
Ingredients: 125 g long grain rice, 300 g water and a pinch of salt	Cooking pot, 16 cm diameter	9	Approx. 2:30	Yes	2	Yes
Ingredients: 250 g long grain rice, 600 g water and a pinch of salt	Saucepan, 22 cm diameter	9	Approx. 2:30	Yes	2.5	Yes
Roasting a pork loin						
Initial temperature of the loin: 7 °C						
Amount: 3 pork loins (total weight approx. 300 g, 1 cm thick) and 15 ml sunflower oil	Frying pan, 24 cm diameter	9	Approx. 1:30	No	7	No
Preparing pancakes**						
Amount: 55 ml batter for each pancake	Frying pan, 24 cm diameter	9	Approx. 1:30	No	7	No
Deep-fat frying chips						
Amount: 1.8 l sunflower oil, per portion: 200 g frozen chips (e.g. McCain 123 Original fries)	Saucepan, 22 cm diameter	9	Until the oil temperature reaches 180 °C	No	9	No

*Recipe in accordance with DIN 44550

**Recipe in accordance with DIN EN 60350-2



Robert Bosch Hausgeräte GmbH

Carl-Wery-Straße 34
81739 München, GERMANY

www.bosch-home.com



9001063720
96033145