

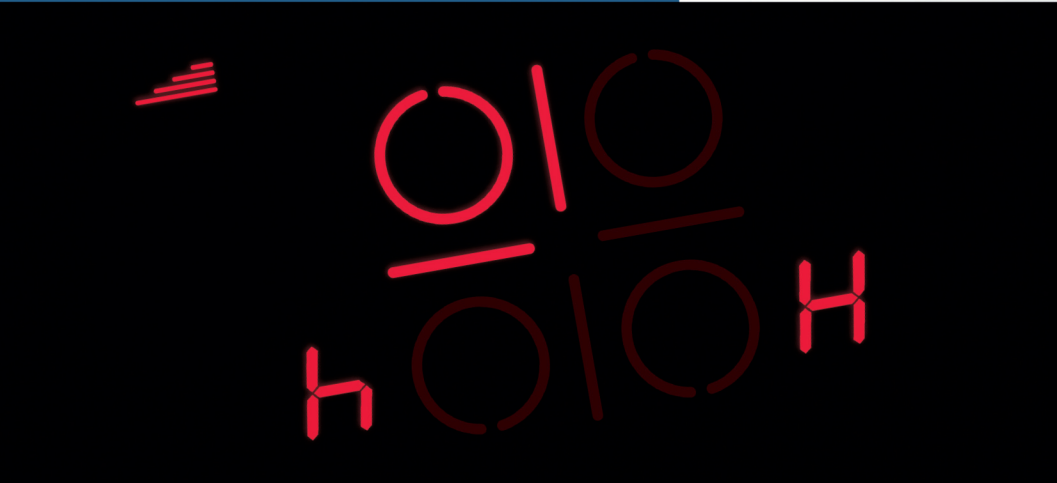

Register your new Bosch now:
www.bosch-home.com/welcome







Hob
PXY...D...



BOSCH

[en] Instruction manual



		g^*	b^*
A / B		2.200 W	3.700 W
		3.300 W	3.700 W
		2.600 W	3.700 W
		3.300 W	3.700 W

*  IEC 60335-2-6

Table of contents

	Intended use	4		Keep warm function	19
	Important safety information	5	Activating	19	
	Causes of damage	6	Deactivating	19	
	Overview	6		Transferring settings	20
	Environmental protection	7	Activation	20	
	Energy-saving advice	7		Frying Sensor	20
	Environmentally-friendly disposal	7	Advantages when frying	20	
	Induction cooking	7	For frying with the frying sensor	20	
	Advantages of induction cooking	7	Temperature settings	21	
	Cookware	7	Table	21	
	Getting to know your appliance	9	Setting procedure	23	
	The control panel	9		Childproof lock	23
	The hotplates	10	Activating and deactivating the childproof lock	23	
	Residual heat indicator	10	Childproof lock	23	
	Operating the appliance	11		Wipe protection	24
	Switching the hob on and off	11		Automatic safety cut-out	24
	Setting a hotplate	11		Basic settings	25
	Chef's recommendations	11	To access the basic settings:	26	
	Flex Zone	14		Energy consumption indicator	27
	Advice on using cookware	14		Cookware check	27
	As two independent hotplates	14		Cleaning	28
	As a single hotplate	14	Hob	28	
	Move function	15	Hob surround	28	
	Activation	15		Frequently Asked Questions (FAQ)	29
	Deactivating	15		Trouble shooting	30
	FlexPlus Zone	16		Customer service	31
	Notes regarding cookware	16	E number and FD number	31	
	Activation	16		Test dishes	32
	Deactivating	16			
	Time-setting options	17			
	Programming the cooking time	17			
	The kitchen timer	17			
	Stopwatch function	18			
	PowerBoost function	18			
	Activating	18			
	Deactivating	18			
	ShortBoost function	19			
	Recommendations for use	19			
	Activating	19			
	Deactivating	19			

Additional information on products, accessories, replacement parts and services can be found at www.bosch-home.com and in the online shop www.bosch-eshop.com

Intended use

Read these instructions carefully. Please keep the instruction and installation manual, as well as the appliance certificate, in a safe place for later use or for subsequent owners.

Check the appliance after removing it from the packaging. If it has suffered any damage in transport, do not connect the appliance, contact the Technical Assistance Service and provide written notification of the damage caused, otherwise you will lose your right to any type of compensation.

This appliance must be installed according to the installation instructions included.

This appliance is intended for private domestic use and the household environment only. The appliance must only be used for the preparation of food and beverages. The cooking process must be supervised. A short cooking process must be supervised without interruption. Only use the appliance in enclosed spaces.

This appliance is intended for use up to a maximum height of 4000 metres above sea level.

Do not use covers. These can cause accidents, due to overheating, catching fire or materials shattering, for example.

Do not use inappropriate child safety shields or hob guards. These can cause accidents.

This appliance is not intended for operation with an external clock timer or a remote control.

This appliance may be used by children over the age of 8 years old and by persons with reduced physical, sensory or mental capabilities or by persons with a lack of experience or knowledge if they are supervised or are instructed by a person responsible for their safety how to use the appliance safely and have understood the associated hazards.

Children must not play with, on, or around the appliance. Children must not clean the appliance or carry out general maintenance unless they are at least 8 years old and are being supervised.

Keep children below the age of 8 years old at a safe distance from the appliance and power cable.

We advise that you exercise caution using or standing near an induction hob while it is in operation, if you wear a pacemaker or a similar medical device. Consult your doctor or the device manufacturer concerning its conformity or any possible incompatibilities,

Important safety information

Warning – Risk of fire!

- Hot oil and fat can ignite very quickly. Never leave hot fat or oil unattended. Never use water to put out burning oil or fat. Switch off the hotplate. Extinguish flames carefully using a lid, fire blanket or something similar.
- The hotplates become very hot. Never place combustible items on the hob. Never place objects on the hob.
- The appliance gets hot. Do not keep combustible objects or aerosol cans in drawers directly underneath the hob.
- The hob switches off automatically and can no longer be operated. It may switch on unintentionally at a later point. Switch off the circuit breaker in the fuse box. Contact the after-sales service.

Warning – Risk of burns!

- The hotplates and surrounding area (particularly the hob surround, if fitted) become very hot. Never touch the hot surfaces. Keep children at a safe distance.
- The hotplate heats up but the display does not work. Switch off the circuit breaker in the fuse box. Contact the after-sales service.
- Metal objects on the hob quickly become very hot. Never place metal objects (such as knives, forks, spoons and lids) on the hob.
- After each use, always turn off the hob at the main switch. Do not wait until the hob turns off automatically after the pan is removed.

Warning – Risk of electric shock!

- Incorrect repairs are dangerous. Repairs may only be carried out and damaged power cables replaced by one of our trained after-sales technicians. If the appliance is defective, unplug the appliance from the mains or switch off the circuit breaker in the fuse box. Contact the after-sales service.
- Do not use any high-pressure cleaners or steam cleaners, which can result in an electric shock.

- A defective appliance may cause electric shock. Never switch on a defective appliance. Unplug the appliance from the mains or switch off the circuit breaker in the fuse box. Contact the after-sales service.
- Cracks or fractures in the glass ceramic may cause electric shocks. Switch off the circuit breaker in the fuse box. Contact the after-sales service.

Warning – Malfunction risk!

The hob is equipped with a fan in the lower section. If there is a drawer under the hob it should not be used to store small objects or paper, since they could damage the fan or interfere with the cooling if they are sucked into it.

There should be a minimum of 2 cm between the contents of the drawer and fan intake.

Warning – Risk of injury!

- When cooking in a bain marie, the hob and cooking container could shatter due to overheating. The cooking container in the bain marie must not directly touch the bottom of the water-filled pot. Only use heat-resistant cookware.
- Saucepans may suddenly jump due to liquid between the pan base and the hotplate. Always keep the hotplate and saucepan bases dry.

Causes of damage

Caution!

- Rough pan bases may scratch the hob.
- Avoid leaving empty pots and pans on the hotplate. Doing so may cause damage.
- Do not place hot pans on the control panel, the indicator area, or the hob frame. Doing so may cause damage.
- Hard or pointed objects dropped on the hob may damage it.
- Aluminium foil and plastic containers will melt if placed on the hotplate while it is hot. The use of laminated sheeting is not recommended on the hob.

Overview

You will find the most frequently caused damage in the following table:

Damage	Cause	Measure
Stains	Boiled over food.	Remove boiled over food immediately with a glass scraper.
	Unsuitable cleaning agent.	Only use cleaning agents that are suitable for this type of hob.
Scratches	Salt, sugar and sand.	Do not use the hob as a work surface or storage space.
	Cookware with rough bases scratch the hob.	Check the cookware.
Discolouration	Unsuitable cleaning agent.	Only use cleaning agents that are suitable for this type of hob.
	Pan abrasion.	Lift pots and pans when moving them.
Chips	Sugar, food with a high sugar content.	Remove boiled over food immediately with a glass scraper.

Environmental protection

In this section, you can find information about saving energy and disposing of the appliance.

Energy-saving advice

- Always use the correct lid for each pan. Cooking without a lid uses a lot more energy. Use a glass lid to provide visibility and avoid having to lift the lid.
- Use pans with flat bases. Bases that are not flat use a lot more energy.
- The diameter of the pan base must match the size of the hotplate. Please note: pan manufacturers usually provide the diameter for the top of the pan, which is usually larger than the diameter of the pan base.
- Use a small pan for small amounts of food. A large pan which is not full uses a lot of energy.
- Use little water when cooking. This saves energy and preserves all the vitamins and minerals in vegetables.
- Select the lowest power level to maintain cooking. If the power level is too high, energy is wasted.

Environmentally-friendly disposal

Dispose of packaging in an environmentally-friendly manner.



This appliance is labelled in accordance with European Directive 2012/19/EU concerning used electrical and electronic appliances (waste electrical and electronic equipment - WEEE). The guideline determines the framework for the return and recycling of used appliances as applicable throughout the EU.

Induction cooking

Advantages of induction cooking

Induction cooking is very different from traditional cooking methods, as heat builds up directly in the item of cookware. This offers numerous advantages:

- Saves time when boiling and frying.
- Saves energy.
- Easier to care for and clean. Spilled food does not burn on as quickly.
- Heat control and safety – the hob increases or decreases the heat supply as soon as the user changes the setting. The induction hotplate stops the heat supply as soon as the cookware is removed from the hotplate, without having to switch it off first.

Cookware

Only use ferromagnetic cookware for induction cooking, such as:

- Cookware made from enamelled steel
- Cookware made from cast iron
- Special induction-compatible cookware made from stainless steel.

To check whether your cookware is suitable for induction cooking, refer to the section on → "Cookware check".

To achieve a good cooking result, the ferromagnetic area on the base of the pan should match the size of the hotplate. If a hotplate does not detect an item of cookware, try placing it on another hotplate with a smaller diameter.

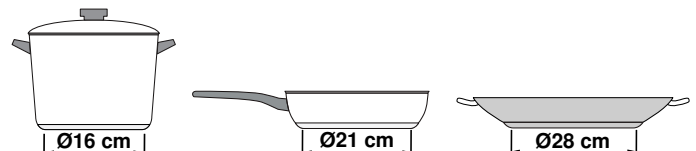

If the only hotplate being used is the flexible cooking zone, larger cookware that is particularly suited to this zone can be used. You can find information on positioning cookware in the section on → "Flex Zone".



Some induction cookware does not have a fully ferromagnetic base:

- If the base of the cookware is only partially ferromagnetic, only the area that is ferromagnetic will heat up. This may mean that heat will not be distributed evenly. The non-ferromagnetic area may not heat up to a sufficient temperature for cooking.

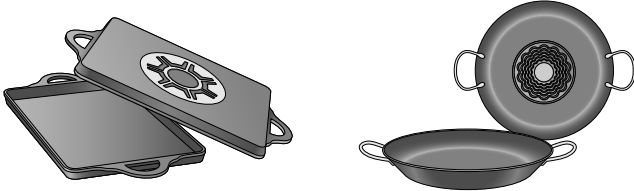

- The ferromagnetic area will also be reduced if the material from which the base of the cookware is made contains aluminium, for example. This may mean that the cookware will not become sufficiently hot or even that it will not be detected.

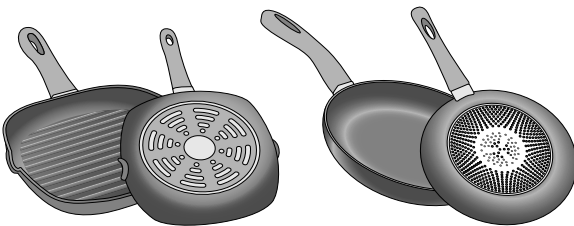

Unsuitable pans

Never use diffuser hobs or pans made from:

- common thin steel
- glass
- earthenware
- copper
- aluminium

Properties of the base of the cookware

The material(s) from which the base of the cookware is made can affect the cooking result. Using pots and pans made from materials that distribute heat evenly through them, such as stainless-steel pans with a three-layer base, saves time and energy.

Use cookware with a flat base; if the base of the cookware is uneven, this may impair the heat supply.



Absence of pan or unsuitable size

If no pan is placed on the selected hotplate, or if it is made of unsuitable material or is not the correct size, the power level displayed on the hotplate indicator will flash. Place a suitable pan on the hotplate to stop the flashing. If this takes more than 90 seconds, the hotplate will switch off automatically.

Empty pans or those with a thin base

Do not heat empty pans, nor use pans with a thin base. The hob is equipped with an internal safety system. However, an empty pan may heat up so quickly that the "automatic switch off" function may not have time to react and the pan may reach very high temperatures. The base of the pan could melt and damage the glass on the hob. In this case, do not touch the pan and switch the hotplate off. If it fails to work after it has cooled down, please contact the Technical Assistance Service.

Pan detection

Each hotplate has a lower limit for pan detection. This depends on the diameter of the ferromagnetic area of the cookware and the material from which its base is made. For this reason, you should always use the hotplate that best matches the diameter of the base of the pan.

Getting to know your appliance

You can find information on the dimensions and power of the hotplates in → *Page 2*

The control panel

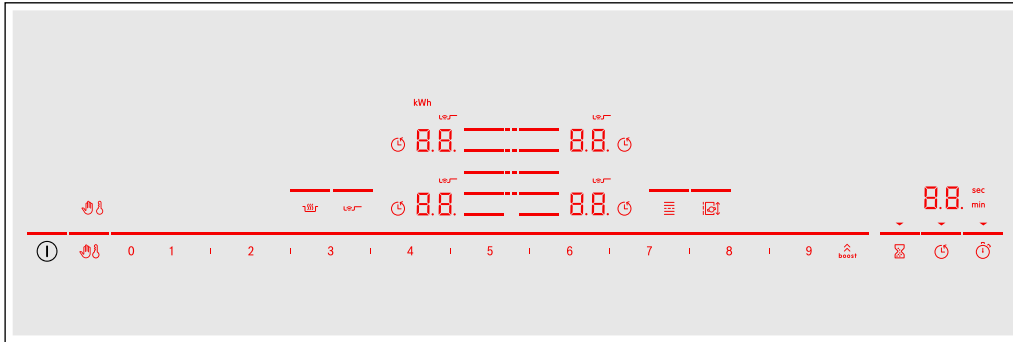

Controls	
①	Main switch
☰	Select a hotplate
0 1 2 1...1 8 9	Settings range
boost	PowerBoost and ShortBoost function
👉	Lock control panel for cleaning
🔒	Childproof lock
🔥	Keep warm function
👉	Frying sensor
☰	Flexible cooking zone
👉	Move function
🕒	Kitchen timer
🕒	Timer function
🕒	Kitchen timer

Displays	
0.0	Operating status
1.0-9.0	Heat settings
H/h	Residual heat
00	Timer function
🔒	Childproof lock
👉	Lock control panel for cleaning
🕒	Programming the cooking time
min / sec	Timer displays
b.	PowerBoost function
Pb.	ShortBoost function
☰	Flexible cooking zone
👉	Frying sensor
⋮	FlexPlus cooking zone
↵	Settings transfer
kWh	Energy consumption
Lo	Keep warm function

Controls



When the hob heats up, the symbols for the controls available at this time light up.

Touching a symbol activates the respective function.

Notes

- The corresponding symbols for the controls light up depending on whether they are available. The displays for the hotplates or the selected functions get brighter.
- Always keep the control panel clean and dry. Moisture can prevent it from working properly.

The hotplates

Hotplates		
	Simple hotplate	Use cookware that is a suitable size.
	Flexible cooking zone	See section → "Flex Zone"
	FlexPlus cooking zone	The FlexPlus cooking zone always switches on in conjunction with the right- or left-hand flexible cooking zone. See section → "FlexPlus Zone"

Only use cookware that is suitable for induction cooking; see section → "Induction cooking"

Residual heat indicator

The hob has a residual heat indicator for each hotplate. This indicates that a hotplate is still hot. Do not touch a hotplate while the residual heat indicator is lit up.

The following are shown depending on the amount of residual heat:

- Display **H**: High temperature
- Display **h**: Low temperature

If you remove the cookware from the hotplate during cooking, the residual heat indicator and the selected heat setting will flash alternately.

When the hotplate is switched off, the residual heat indicator will light up. Even after the hob has been switched off, the residual heat indicator will stay lit for as long as the hotplate is still warm.

Operating the appliance

This chapter explains how to set a hotplate. The table shows heat settings and cooking times for various meals.

Switching the hob on and off

The main switch is used to switch the hob on and off.

To switch on: Touch the ① symbol. An audible signal sounds. The symbols for the hotplates and the functions available at this time light up. The 0.0 symbol lights up next to the hotplates. The hob is ready to use.

To switch off: Touch the ① symbol until the indicators go out. The residual heat indicator remains lit until the hotplates have cooled down sufficiently.

Notes

- The hob switches off automatically if all hotplates have been switched off for more than 20 seconds.
- The selected settings are stored for four seconds after the hob has been switched off. If you switch it on again during this time, the hob will operate using the previously stored settings.

Setting a hotplate

Set the required heat setting using the 1 to 9 symbols.

Heat setting 1 = lowest setting.

Heat setting 9 = highest setting.

Every heat setting has an intermediate setting. This is marked in the control panel with the I symbol.

Selecting a hotplate and heat setting

The hob must be switched on.

1. Touch the ≡ symbol for the required hotplate. The 0.0 display gets brighter.
2. Then select the required heat setting from the settings range.

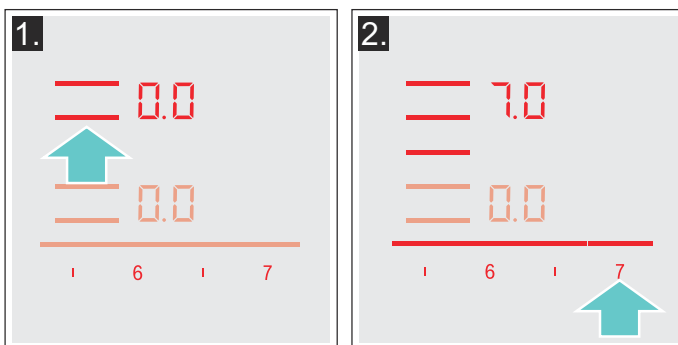

The heat setting is set.

Changing the heat setting

Select the hotplate and then set the required heat setting in the control panel.

Switching off the hotplate

Select the hotplate and set it to 0.0 in the settings range. The hotplate switches itself off and the residual heat indicator appears.

Notes

- If no pan has been placed on the hotplate, the selected power level flashes. After a certain time has elapsed, the hotplate switches off.
- If a pan has been placed on the hotplate before switching on the hob, it will be detected within 20 seconds of pressing the main switch and the hotplate will be selected automatically. Once detected, select the power level within the next 20 seconds or the hotplate will switch off. If more than one pan is placed on the hob, only one will be detected when switching it on.

Chef's recommendations

Recommendations

- When heating up puree, cream soups and thick sauces, stir occasionally.
- Set heat setting 8 to 9 for preheating.
- When cooking with the lid on, turn the heat setting down as soon as steam escapes between the lid and the cookware. Steam does not need to escape for a good cooking result.
- After cooking, keep the lid on the cookware until you serve the food.
- To cook with the pressure cooker, observe the manufacturer's instructions.
- Do not cook food for too long, otherwise the nutrients will be lost. The kitchen clock can be used to set the optimum cooking time.
- For a more healthy cooking result, smoking oil should be avoided.
- To brown food, fry small portions in succession.
- Cookware may reach high temperatures while the food is cooking. We recommend that you use oven gloves.
- You can find recommendations for energy-efficient cooking in section → "Environmental protection"

Cooking table

The table shows which heat setting is suitable for each type of food. The cooking time may vary depending on the type, weight, thickness and quality of the food.

	Heat setting	Cooking time (mins)
Melting		
Chocolate coating	1 - 1.5	-
Butter, honey, gelatine	1 - 2	-
Heating and keeping warm		
Stew, e.g. lentil stew	1.5 - 2	-
Milk*	1.5 - 2.5	-
Heating sausages in water*	3 - 4	-
Defrosting and heating		
Spinach, frozen	3 - 4	15 - 25
Goulash, frozen	3 - 4	35 - 45
Poaching, simmering		
Potato dumplings*	4.5 - 5.5	20 - 30
Fish*	4 - 5	10 - 15
White sauces, e.g. Béchamel sauce	1 - 2	3 - 6
Whisked sauces, e.g. sauce béarnaise, hollandaise	3 - 4	8 - 12
Boiling, steaming, braising		
Rice (with double the volume of water)	2.5 - 3.5	15 - 30
Rice pudding***	2 - 3	30 - 40
Unpeeled boiled potatoes	4.5 - 5.5	25 - 35
Boiled potatoes	4.5 - 5.5	15 - 30
Pasta, noodles*	6 - 7	6 - 10
Stew	3.5 - 4.5	120 - 180
Soups	3.5 - 4.5	15 - 60
Vegetables	2.5 - 3.5	10 - 20
Vegetables, frozen	3.5 - 4.5	7 - 20
Cooking in a pressure cooker	4.5 - 5.5	-
Braising		
Roulades	4 - 5	50 - 65
Pot roast	4 - 5	60 - 100
Goulash***	3 - 4	50 - 60

* Without lid

** Turn several times

*** Preheat to heat setting 8 - 8.5

	Heat setting	Cooking time (mins)
Roasting/frying with little oil*		
Escalope, plain or breaded	6-7	6-10
Escalope, frozen	6-7	8-12
Chop, plain or breaded**	6-7	8-12
Steak (3 cm thick)	7-8	8-12
Poultry breast (2 cm thick)**	5-6	10-20
Poultry breast, frozen**	5-6	10-30
Rissoles (3 cm thick)**	4.5-5.5	20-30
Hamburgers (2 cm thick)**	6-7	10-20
Fish and fish fillet, plain	5-6	8-20
Fish and fish fillet, breaded	6-7	8-20
Fish, breaded and frozen, e.g. fish fingers	6-7	8-15
Scampi, prawns	7-8	4-10
Sautéing fresh vegetables and mushrooms	7-8	10-20
Stir-fry, vegetables, meat cut in Asian-style strips	7-8	15-20
Stir fry, frozen	6-7	6-10
Pancakes (baked in succession)	6.5-7.5	-
Omelette (cooked in succession)	3.5-4.5	3-6
Fried eggs	5-6	3-6
Deep-fat frying* (150-200 g per portion in 1-2 l oil, deep-fat fried in portions)		
Frozen products, e.g. chips, chicken nuggets	8-9	-
Croquettes, frozen	7-8	-
Meat, e.g. chicken portions	6-7	-
Fish, breaded or in beer batter	6-7	-
Vegetables, mushrooms, breaded or battered, tempura	6-7	-
Small baked items, e.g. doughnuts, fruit in batter	4-5	-
* Without lid		
** Turn several times		
*** Preheat to heat setting 8 - 8.5		

Flex Zone

You can use the hob as a single hotplate or as two independent hotplates, as required.

It consists of four inductors that work independently of each other. If using the flexible cooking zone, only the area that is covered by cookware is activated.

Advice on using cookware

To ensure that the cookware is detected and heat is distributed evenly, correctly centre the cookware:

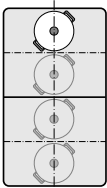
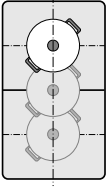
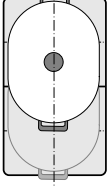
As a single hotplate	
	Diameter smaller than or equal to 13 cm Place the cookware on one of the four positions that can be seen in the illustration.
	Diameter greater than 13 cm Place the cookware on one of the three positions that can be seen in the illustration.
	If the cookware takes up more than one hotplate, place it starting on the upper or lower edge of the flexible cooking zone.

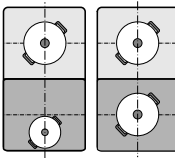
As two independent hotplates	
	The front and rear hotplates each have two inductors and can be used independently of each other. Select the required heat setting for each of the hotplates. Use only one item of cookware on each hotplate.

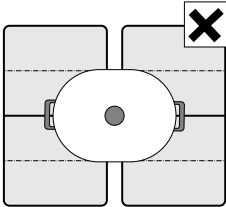
Recommendations	
	If the hob has more than one flexible cooking zone, place the cookware on top so that it covers only one of the flexible cooking zones. Otherwise, the hotplates will not be activated as intended and the cooking result will not be satisfactory.

As two independent hotplates

The flexible cooking zone is used like two independent hotplates.

Activating

See section → "Operating the appliance"

As a single hotplate

Using the entire cooking zone by connecting both hotplates.

Linking the two hotplates

1. Set down the cookware. Select one of the two hotplates assigned to the flexible cooking zone and set the heat setting.
2. Touch the  symbol. The display lights up. The heat setting appears in the display for the lower hotplate.

The flexible cooking zone is activated.

Changing the heat setting

Select one of the two hotplates in the flexible cooking zone and change the heat setting in the settings range.

Adding a new item of cookware

Set the new item of cookware down on the cooker, select one of the two hotplates in the flexible cooking zone and then touch the  symbol twice. The new item of cookware will be detected and the heat setting that was previously selected will be retained.

Note: If the cookware is moved to the hotplate being used or lifted up, the hotplate begins an automatic search and the heat setting selected previously is retained.

Disconnecting the two hotplates

Select one of the two hotplates in the flexible cooking zone and touch the  symbol.

This deactivates the flexible cooking zone. The two hotplates will now function independently.

Notes

- If the hotplate is switched off, and then switched back on again later, the flexible cooking zone is reset to function as two independent hotplates.
- To change the configuration settings for the flexible cooking zone, refer to section → "Basic settings".

Move function

This function activates the entire flexible cooking zone, which is divided into three cooking areas and which has preset heat settings.

Only use one item of cookware. The size of the cooking area depends on the cookware used and whether it is positioned correctly.

Cooking areas

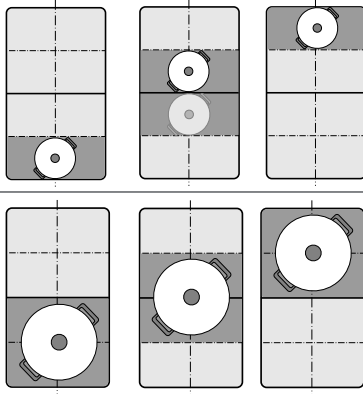

This means that an item of cookware can be moved during the cooking process to another cooking area with another heat setting:

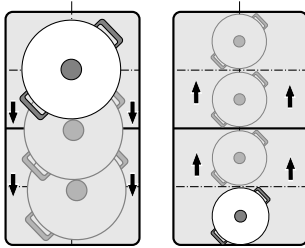

Preset heat settings:

Front area = heat setting **9**

Middle area = heat setting **5**



Rear area = heat setting **1.5**

The preset heat settings can be changed independently of one another. You can find out how to change these in the section on → "Basic settings".

Notes

- If more than one item of cookware is detected on the flexible cooking zone, the function is deactivated.
- If the cookware is moved within the flexible cooking zone or lifted up, the hob automatically starts searching and the heat setting of the area in which the vessel was detected is set.
- You can find information on the size and positioning of the cookware in the section on → "Flex Zone"

Activation

1. Select one of the two hotplates in the flexible cooking zone.
2. Touch the  symbol. The indicator beside the  symbol lights up. The flexible cooking zone is activated as a single hotplate. The heat setting in the area in which the cookware is located lights up in the hotplate display. The function has now been activated.



Changing the heat setting

The heat settings for the individual cooking areas can be changed during the cooking process. Set the cookware down on the cooking area and change the heat setting in the settings range.

Notes

- Only the heat setting in the area in which the cookware is located is changed.
- If the function is deactivated, the heat settings for the three cooking areas are reset to the preset values.

Deactivating

Touch the  symbol. The indicator beside the  symbol goes out.

The function was deactivated.

Note: If one of the cooking areas is set to , the function deactivates after a few seconds.

FlexPlus Zone

The hob has a FlexPlus cooking zone which is located between the two flexible cooking zones and which switches on in conjunction with the right- or left-hand flexible cooking zone. This means that larger cooking vessels can be used and better cooking results can be achieved.

The FlexPlus cooking zone always switches on in conjunction with one of the two flexible cooking zones. It is not possible to activate these cooking zones independently.

Notes regarding cookware

The cookware should be positioned centrally for good thermal detection and distribution.

The cookware should cover the side hotplate and the FlexPlus cooking zone.

Depending on the size of the cookware, the flexible cooking zone can be activated as two independent hotplates or as one hotplate:

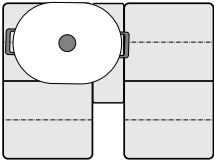
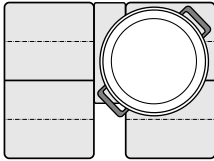
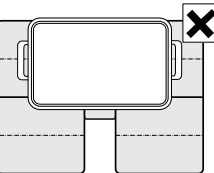
Set down the cookware	
	Oblong cookware Activate the flexible cooking zone as two independent hotplates or as one hotplate.
	Large round cookware Activate the flexible cooking zone as a single hotplate.
	The vessel must not cover the two side cooking zones and the FlexPlus cooking zone at the same time.

Activation

1. Set down the cookware on the hotplate and make sure that it also covers the FlexPlus cooking zone.
2. Select the hotplate and the required heat setting. The hotplate and FlexPlus cooking zone indicators light up.

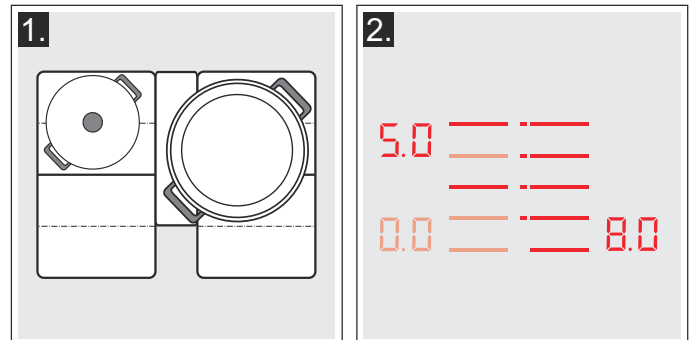

The flexible cooking zone is activated.

Note: If the two hotplates next to the FlexPlus cooking zone are covered by the cookware, the display in the FlexPlus cooking zone flashes before the hob is switched on.

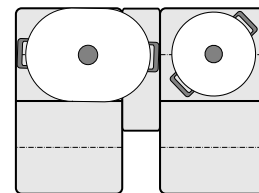

To link the FlexPlus cooking zone to the corresponding hotplate, lift up the cookware, select a heat setting and then place the cookware back down.

Deactivating

Remove the cookware from the hotplate. The displays go out.

This deactivates the FlexPlus cooking zone.

Time-setting options





Your hob has three timer functions:

- Programming the cooking time
- Kitchen timer
- Stopwatch function

Programming the cooking time

The hotplate automatically switches off after the time that is set has elapsed.

Setting procedure:

1. Select the hotplate and the required heat setting.
2. Touch the  symbol. The  symbol and the  indicator light up in the timer display.  lights up in the display for the hotplate.



3. Within the next 10 seconds, set the required cooking time in the settings range.



4. Touch the  symbol to confirm the selected setting.

The cooking time begins to elapse.

Notes

- The same cooking time can be set automatically for all hotplates. The set time for each of the hotplates counts down independently. You can find information on automatically programming the cooking time in section → "Basic settings"
- If the flexible cooking zone is selected as the only hotplate, the set time for the entire cooking zone is the same.
- If the Move function is selected for the combined hotplate, the set time for the three hotplates is the same.

Frying sensor

If a cooking time has been programmed for a hotplate and the frying sensor has been activated, the cooking time will not begin to count down until the selected temperature setting has been reached.



Changing or deleting the time



Select the hotplate and then touch the  symbol.

Change the cooking time in the settings range or set  to delete the programmed cooking time.

Touch the  symbol to confirm the selected setting.

When the time has elapsed

The hotplate switches off, the  display flashes and the hotplate switches to the  heat setting. An audible signal sounds.

 and the  indicator flash in the timer display.

When the  symbol is touched, the indicators go out and the acoustic signal ceases.

Notes





- To set a cooking time of under 10 minutes, always touch **0** before you select the required value.
- If a cooking time was programmed for several hotplates, the time information for the selected hotplate is shown in the timer display.
- Select the relevant hotplate to call up the remaining cooking time.
- You can set a cooking time of up to **99** minutes.

The kitchen timer

You can use the kitchen timer to set a time of up to 99 minutes.

This functions independently from the hotplates and from other settings. This function does not automatically switch off a hotplate.

Setting procedure

1. Touch the  symbol. The  symbol and the  indicator light up in the timer display.
2. Select the required time on the control panel and touch the  symbol to confirm.

After a few seconds, the time begins to elapse.



Changing or deleting the time

Touch the  symbol.

Change the cooking time in the settings range or set  to delete the programmed cooking time.

Touch the  symbol to confirm the selected setting.

When the time has elapsed

An audible signal sounds once the time has elapsed.  and the  symbol flash in the timer display.



The indicators go out after touching the  symbol.

Stopwatch function

The stopwatch function displays the time that has elapsed since activation.

This functions independently from the hotplates and from other settings. This function does not automatically switch off a hotplate.

Activating

Touch the  symbol. The  symbol and the  indicator light up in the timer display.

The cooking time begins to elapse.

Deactivating

Touching the  symbol stops the stopwatch function. The timer displays remain lit.

If you touch the  symbol again, the displays go out.

The function is deactivated.

PowerBoost function

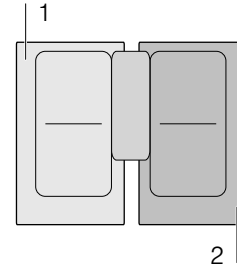

The PowerBoost function enables you to heat up large quantities of water faster than when using heat setting .

This function can always be activated for a hotplate, provided the other hotplate in the same group is not in use (see illustration).





Note: The PowerBoost function can also be activated in the flexible area if the cooking zone is being used as a single hotplate.

Activating

1. Select a hotplate.
2. Touch the  symbol.
The  indicator lights up.
The function is activated.

Deactivating

1. Select a hotplate.
 2. Touch the  symbol.
The  display goes out and the hotplate switches back to heat setting .
- The function is deactivated.

Note: In certain circumstances, the PowerBoost function can switch itself off automatically in order to protect the electronic elements inside the hob.

ShortBoost function

The PowerBoost function enables you to heat cookware faster than when using heat setting 9.

After deactivating the function, select the appropriate heat setting for your food.

This function can always be activated for a hotplate, provided the other hotplate in the same group is not in use (see illustration).

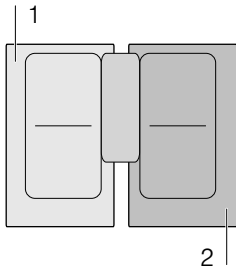



Note: With the flexible cooking zone, the ShortBoost function can be activated even if it is used as the only cooking zone.



Recommendations for use

- Always use cookware that has not been pre-heated.
- Use pots and pans with a flat base. Do not use cookware with a thin base.
- Never leave empty cookware, oil, butter or lard to heat up unattended.
- Do not place a lid on the cookware.
- Place the cookware on the centre of the hotplate. Ensure that the diameter of the base of the cookware corresponds to the size of the hotplate.
- You can find information on the type, size and positioning of the cookware in section → "Induction cooking"

Activating

1. Select a hotplate.
2. Touch the  symbol twice.
The  indicator lights up.
The function is activated.

Deactivating



1. Select a hotplate.
2. Touch the  symbol.
The  display goes out and the hotplate switches back to heat setting 9.
The function is deactivated.

Note: In certain circumstances, the ShortBoost function can switch itself off automatically in order to protect the electronic elements inside the hob.



Keep warm function

This function is suitable for melting chocolate or butter and for keeping food warm.

Activating

1. Select the required heat setting.
2. Within the next 10 seconds, touch the  symbol.
The  indicator lights up.
The function is activated.

Deactivating

1. Select a hotplate.
2. Touch the  symbol.
The  display goes out. The hotplate switches itself off and the residual heat indicator appears.
The function is deactivated.

Transferring settings

The heat setting and the programmed cooking time can be transferred from one hotplate to another using this function.

To transfer the settings, move the cookware from the hotplate which is switched on to another hotplate.

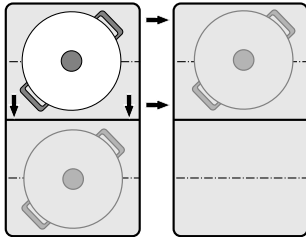

Note: You can find additional information on the positioning of the cookware in the section on → "Flex Zone"

Activation

1. Move the cookware from the hotplate which is switched on to another hotplate.
The heat setting of the original hotplate flashes. The cookware is detected and the previously selected heat setting and the  symbol flash in the new hotplate display.
2. Select the new hotplate to confirm the settings.
The heat setting of the original hotplate is set to **00**.



The settings have been transferred to the new hotplate.

Notes

- Move the cookware to a hotplate which is not switched on, which you have not yet preset or on which no other cookware has been placed.
- The PowerBoost or ShortBoost function can then only be moved from left to right or right to left if no hotplate is active.
- If a new item of cookware is set down on another hotplate before the settings have been confirmed, this function is ready for both cooking vessels.
- If several vessels are moved, the function is only ready for the vessel which was last moved.

Frying Sensor

This function can be used to fry food while maintaining the suitable frying pan temperature.

The cooking zones that have this function are identified by the roasting function symbol.

Advantages when frying

- The hotplate only heats up if this is required to maintain the temperature. This saves energy and prevents the oil or fat from overheating.
- The roasting function reports when the empty frying pan has reached the optimum temperature for adding oil and then for adding the food.

Notes

- Do not place a lid on the pan. Otherwise, the function does not activate correctly. You can use a splash guard to prevent splashes of grease.
- Use suitable oil or fat for frying. If butter, margarine, extra virgin olive oil or lard is used, set heat setting 1 or 2.
- Never leave a frying pan, with or without food, unattended when it is being heated.
- If the hotplate is a higher temperature than the cookware or vice versa, the frying sensor will not be activated correctly.

For frying with the frying sensor

Frying pans that are perfect for using with the frying sensor can be purchased from specialist retailers or through our technical after-sales service. Quote the relevant reference number:

- HEZ390210 15 cm frying pan.
- HEZ390220 19 cm frying pan.
- HEZ390230 21 cm frying pan.
- HEZ390250 28 cm frying pan. Only recommended for the FlexPlus cooking zone.

These frying pans have a non-stick coating so that you require only a small amount of oil to fry food.

Notes

- The frying sensor has been configured specifically for this type of frying pan.
- Ensure that the diameter of the base of the frying pan corresponds to the size of the hotplate. Put the frying pan in the centre of the hotplate.
- Using a frying pan of a different size or one that is poorly positioned on the flexible cooking zones may result in the frying sensor not being activated. See the section on → "Flex Zone".
- Other frying pans may overheat. They may reach a temperature above or below the selected temperature setting. Try the lowest temperature setting to begin with and change it if necessary.

Temperature settings

Temperature setting	Suitable for
1	Very low
2	Low
3	Medium - low
4	Medium - high
5	High

Table

The table shows which heat setting is suitable for each type of food. The roasting time may vary depending on the type, weight, size and quality of the food.

The set heat setting varies depending on the frying pan that is used.

Preheat the empty pan; add oil and food after the acoustic signal has sounded.

	Temperature setting	Total frying time after the signal sounds (mins.)
Meat		
Escalope, plain or breaded	4	6 - 10
Fillet	4	6 - 10
Chops*	3	10 - 15
Cordon bleu, Wiener Schnitzel*	4	10 - 15
Steak, rare (3 cm thick)	5	6 - 8
Steak, medium or well-done (3 cm thick)	4	8 - 12
Poultry breast (2 cm thick)*	3	10 - 20
Sausages, pre-boiled or raw*	3	8 - 20
Hamburger, meatballs, rissoles*	3	6 - 30
Meat loaf	2	6 - 9
Ragout, gyros	4	7 - 12
Ground meat	4	6 - 10
Bacon	2	5 - 8
Fish		
Fish, fried, whole, e.g. trout	3	10 - 20
Fish fillet, plain or breaded	3 - 4	10 - 20
Prawns, scampi	4	4 - 8
Egg dishes		
Pancakes**	5	-
Omelette**	2	3 - 6
Fried eggs	2 - 4	2 - 6
Scrambled eggs	2	4 - 9
Raisin pancake	3	10 - 15
French toast**	3	4 - 8

* Turn several times.

** Total cooking time per portion. Fry in succession.



	Temperature setting	Total frying time after the signal sounds (mins.)
Potatoes		
Fried potatoes (boiled in their skin)	5	6 - 12
French fries (made from raw potatoes)	4	15 - 25
Potato fritter**	5	2,5 - 3,5
Swiss rösti	1	50 - 55
Glazed potatoes	3	15 - 20
Vegetables		
Garlic, onions	1 - 2	2 - 10
Courgettes, aubergines	3	4 - 12
Peppers, green asparagus	3	4 - 15
Vegetables sautéed in oil, e.g. courgettes, green peppers	1	10 - 20
Mushrooms	4	10 - 15
Glazed vegetables	3	6 - 10
Frozen products		
Escalope	4	15 - 20
Cordon bleu*	4	10 - 30
Poultry breast*	4	10 - 30
Chicken nuggets	4	10 - 15
Gyros, kebab	3	5 - 10
Fish fillet, plain or breaded	3	10 - 20
Fish fingers	4	8 - 12
French fries	5	4 - 6
Stir-fries meals, e.g. fried vegetables with chicken	3	6 - 10
Spring rolls	4	10 - 30
Camembert/cheese	3	10 - 15
Sauces		
Tomato sauce with vegetables	1	25 - 35
Béchamel sauce	1	10 - 20
Cheese sauce, e.g. Gorgonzola sauce	1	10 - 20
Reducing sauces, e.g. tomato sauce, Bolognese sauce	1	25 - 35
Sweet sauces, e.g. orange sauce	1	15 - 25
Miscellaneous		
Camembert/cheese	3	7 - 10
Dry ready meals that require water to be added, e.g. pasta	1	5 - 10
Croutons	3	6 - 10
Almonds/walnuts/pine nuts	4	3 - 15

* Turn several times.

** Total cooking time per portion. Fry in succession.

Setting procedure

Select the appropriate temperature setting from the table. Place the empty frying pan on the hotplate.

1. Select the hotplate. Touch the  symbol.  lights up in the hotplate display.

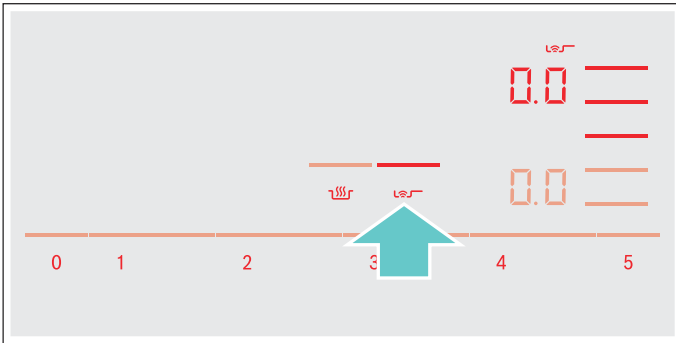

2. Within the next 10 seconds, select the required temperature setting from the settings range.

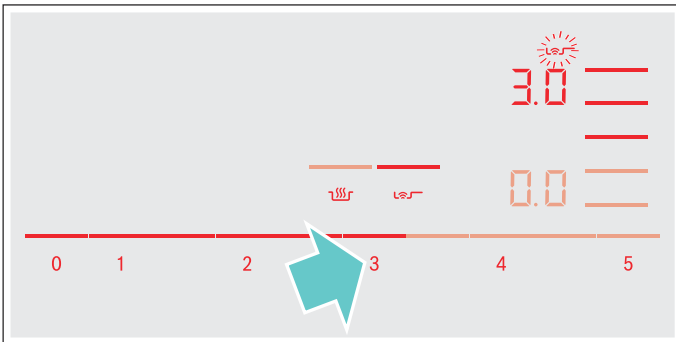

The function has now been activated.

The  temperature symbol flashes until the frying temperature is reached. A signal sounds and the temperature symbol goes out.

3. Once the frying temperature has been reached, add the fat and then the food to the pan.

Note: Turn the food so that it does not burn.

Switching off the frying sensor

Select the hotplate and set it to  in the settings range. The hotplate switches itself off and the residual heat indicator appears.



Childproof lock

You can use the childproof lock to prevent children from switching on the hob.

Activating and deactivating the childproof lock

The hob must be switched off.

To activate:

1. Switch on the hob using the main switch.
2. Touch the  symbol for approx. 4 seconds. The  indicator lights up for 10 seconds. The hob is locked.

To deactivate:

1. Switch on the hob using the main switch.
2. Touch the  symbol for approx. 4 seconds. The lock is released.

Childproof lock

With this function, the childproof lock automatically activates when a hob is switched off.

Switching on and off

You can find out how to switch the automatic childproof lock on in the → "Basic settings" section



Wipe protection

If you wipe over the control panel while the hob is switched on, settings may be altered. To avoid doing this, you can use the hob's "Lock control panel for cleaning" function.

To switch on: Touch the  symbol. An audible signal sounds. The control panel is locked for 35 seconds. You can now wipe over the surface of the control panel without altering any settings.

To deactivate: The control panel will be unlocked once 35 seconds have elapsed. To release the function early, touch the  symbol.

Notes

- An audible signal sounds 30 seconds after activation. This indicates that the function is about to finish.
- The cleaning lock does not lock the main switch. The hob can be switched off at any time.



Automatic safety cut-out

If a hotplate operates for an extended period and no settings are changed, the automatic safety shut-off is activated.

The hotplate stops heating. **FE** and the residual heat indicator **h** or **H** flash alternately in the hotplate display.

When you touch any symbol, the display switches off. The hotplate can now be set again.

The point at which the safety shut-off becomes active depends on which heat setting has been set (after 1 to 10 hours).

Basic settings

The appliance has various basic settings. You can adapt these to suit your cooking habits.

Display	Function
c 1	Automatic childproof lock 0 Manual*. 1 Automatic. 2 Function deactivated.
c 2	Audible signals 0 Confirmation and fault signals are switched off. 1 Only the fault signal is switched on. 2 Only the confirmation signal is switched on. 3 All signal tones are switched on.*
c 3	Display energy consumption 0 Switched off.* 1 Switched on.
c 5	Automatically programming the cooking time 00 Switched off.* 0 1-99 Time until automatic switch-off.
c 6	Duration of the timer-end signal tone 1 10 seconds.* 2 30 seconds. 3 1 minute.
c 7	Power management function. Limiting the total power of the hob 0 Switched off.* 1 1000 W minimum power. 1. 1500 W. 2 2000 W. ... 9 or 9. Maximum power of the hob.
c 11	Changing the preset heat settings for the Move function -9 Preset heat setting for the front cooking zone. -5 Preset heat setting for the central cooking zone. -1. Preset heat setting for the rear cooking zone.
c 12	Checking cookware and cooking results 0 Not suitable 1 Not perfect 2 Suitable
c 13	Configuring activation of the flexible cooking zone 0 As two independent hotplates.* 1 As a single hotplate.

* Factory settings

Display	Function
	Restoring the factory settings
	Individual settings.*
	Restore factory settings.

* Factory settings

To access the basic settings:

The hob must be off.

1. Switch on the hob.
2. Within ten seconds, touch and hold the symbol for approximately four seconds.
The first four displays provide product information.
Touch the settings area to view the individual displays.

Product information	Display screen
After-sales service index (ASSI)	
Production number	
Production number 1	
Production number 2	

3. Touching the symbol again takes you to the basic settings.
 and light up as a preset in the displays.



4. Touch the symbol repeatedly until the required function is displayed.
5. Then select the required setting from the settings area.

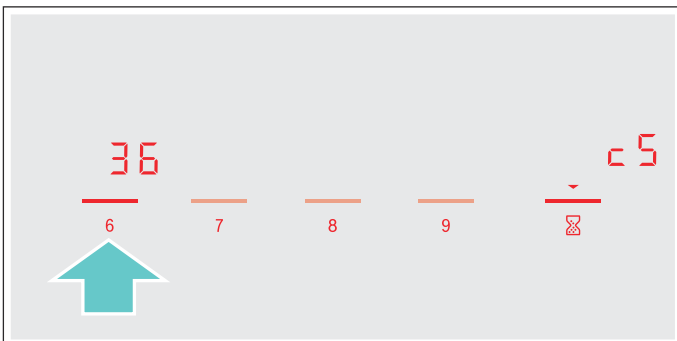

6. Touch the symbol for at least four seconds.
The settings have been saved.

Leaving the basic settings

Turn off the hob with the main switch.

Energy consumption indicator

This function indicates the total amount of energy consumed by this hob the last time it was used for cooking.

Once switched off, the energy consumption in kWh is displayed for 10 seconds.

The picture shows an example with an energy consumption of **1.08** kWh.

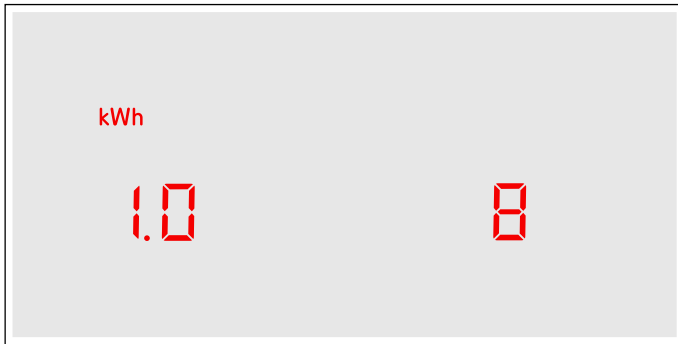

You can find out how to switch this function on in the section on → "Basic settings"

Cookware check

This function can be used to check the speed and quality of the cooking process depending on the cookware.

The result is a reference value and depends on the properties of the cookware and the hotplate being used.

1. With the cookware still cold, fill it with approx. 200 ml of water and place it on the centre of the hotplate with the diameter that most closely matches that of the base of the cookware.
2. Go to the basic settings and select the **C 12** setting.
3. Touch the settings range. **—** will flash on the hotplate display.

The function has now been activated.

After 10 seconds, the result for the quality and speed of the cooking process will appear on the hotplate display.

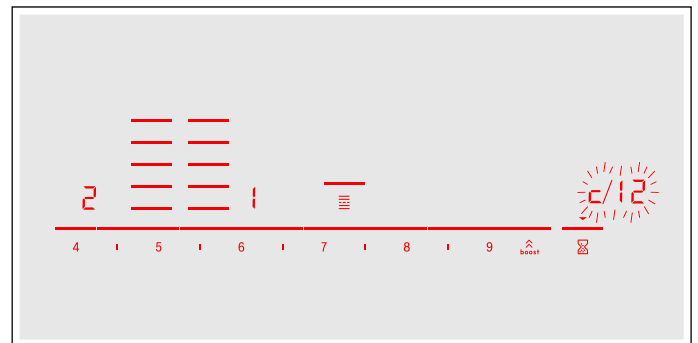

Check the result using the following table:

Result

0	The cookware is not suitable for the hotplate and will therefore not heat up.*
1	The cookware is taking longer to heat up than expected and the cooking process is not going as well as it should.*
2	The cookware is heating up correctly and the cooking process is going well.

* If there is a smaller hotplate available, test the cookware again on the smaller hotplate.

To reactivate this function, touch the settings range.

Notes

- The flexible cooking zone only counts as a single hotplate; place no more than one item of cookware on it.
- If the diameter of the hotplate used is much smaller than the diameter of the cookware, only the middle of the cookware can be expected to heat up. This may result in the cooking results not being as good as expected or being less than satisfactory.
- You can find information on this function in the section on → "Basic settings".
- You can find information on the type, size and positioning of the cookware in the sections on → "Induction cooking" and → "Flex Zone".

Cleaning

Suitable maintenance and cleaning products can be purchased from the after-sales service or in our e-Shop.

Hob

Cleaning

Always clean the hob after cooking. This will prevent food deposits from becoming burned on. Only clean the hob after the residual heat indicator has gone out.

Clean the hob with a damp dish cloth and dry it with a cloth or towel to prevent limescale build-up.

Only use cleaning agents that are suitable for this type of hob. Observe the manufacturer's instructions on the product packaging.

Never use:

- Undiluted washing-up liquid
- Cleaning agents designed for dishwashers
- Abrasive cleaners
- Harsh cleaning agents, such as oven spray and limescale remover
- Scouring pads
- High-pressure cleaners or steam jet cleaners

Stubborn dirt is best removed with a glass scraper, available from retailers. Observe the manufacturer's instructions.

You can obtain a suitable glass scraper from customer services or through our online shop.

Using a special sponge for cleaning glass-ceramic hobs achieves a great cleaning result.

Potential marks	
Limescale and water marks	Clean the hob as soon as it has cooled down. You can use a cleaning agent suitable for glass-ceramic hobs.*
Sugar, rice starch or plastic	Clean immediately. Use a glass scraper. Caution: Risk of burns.*
* Then clean with a damp dish cloth and dry with a cloth or towel.	

Note: Do not use any cleaning agents while the hob is still hot. This may mark the surface. Make sure that any residue left by cleaning agents is removed.

Hob surround

To prevent damage to the hob surround, observe the following instructions:

- Only use warm soapy water
- Wash new dish cloths thoroughly before use.
- Do not use harsh or abrasive cleaning agents.
- Do not use a glass scraper or sharp objects.

Frequently Asked Questions (FAQ)

Using the appliance

Why can't I switch on the hob and why is the childproof lock symbol lit?

The childproof lock is activated.
You can find information on this function in the section on → "*Childproof lock*"

Why are the displays flashing and why can I hear an audible signal?

Remove any liquid or food remains from the control panel. Remove any objects from the control panel.
You can find instructions on how to deactivate the audible signal in the section on → "*Basic settings*"

Noises

Why I can hear noises while I'm cooking?

Noises may be generated while using the hob depending on the base material of the cookware. These noises are a normal part of induction technology. They do not indicate a defect.

Possible noises:

A low humming noise like the one a transformer makes:

Occurs when cooking at a high heat setting. The noise disappears or becomes quieter when the heat setting is reduced.

Low whistling noise:

Occurs when the cookware is empty. This noise disappears when water or food is added to the cookware.

Crackling:

Occurs when using cookware made from different layers of material or when using cookware of different sizes and different materials at the same time. The loudness of the noise can vary depending on the quantity of food being cooked or the cooking method.

High-pitched whistling noises:

Can occur when two hotplates are used at the highest heat setting at the same time. The whistling noises disappear or become quieter when the heat setting is reduced.

Fan noise:

The hob is equipped with a fan that switches on automatically at high temperatures. The fan may continue to run even after you have switched off the hob if the temperature detected is still too high.

Cookware

Which types of cookware can be used with an induction hob?

You can find information on which types of cookware can be used with an induction hob in the section on → "*Induction cooking*".

Why is the hotplate not heating up and why is the heat setting flashing?

The hotplate on which the cookware is standing is not switched on.
Check that you have switched on the correct hotplate.

The cookware is too small for the hotplate that is switched on or it is not suitable for induction cooking.

Check that the cookware is suitable for induction cooking and that it is placed on the hotplate that best corresponds to its size. You can find information on the type, size and positioning of cookware in the sections on → "*Induction cooking*", → "*Flex Zone*" and → "*Move function*".

Why is it taking so long for the cookware to heat up or why is it not heating up sufficiently despite being on a high heat setting?

The cookware is too small for the hotplate that is switched on or it is not suitable for induction cooking.

Check that the cookware is suitable for induction cooking and that it is placed on the hotplate that best corresponds to its size. You can find information on the type, size and positioning of cookware in the sections on → "*Induction cooking*", → "*Flex Zone*" and → "*Move function*".

Cleaning

How do I clean the hob?

Using a special glass-ceramic cleaning agent produces the best results. We advise against using harsh or abrasive cleaning agents, dishwasher detergent (concentrated) or scouring pads.

You can find more information on cleaning and caring for your hob in the section on → "Cleaning"

? Trouble shooting

Usually, faults are small matters that are easy to eliminate. Please read the information in the table before calling the after-sales service.

Display	Possible cause	Solution
None	The power supply has been disconnected. The device has not been connected in accordance with the circuit diagram. Electronics fault.	Use other electrical devices to check whether a short-circuit has occurred in the power supply. Ensure that the device has been connected in accordance with the circuit diagram. If the fault cannot be eliminated, inform the technical after-sales service.
The displays flash	The control panel is damp or an object is covering it.	Dry the control panel or remove the object.
The – indicator flashes in the hotplate displays	A fault has occurred in the electronics.	To acknowledge the fault, cover the control panel with your hand.
F2 F4	The electronics have overheated and have switched off the corresponding hotplate. The electronics have overheated and have switched off all hotplates.	Wait until the electronics have cooled down sufficiently. Then touch any symbol on the hob.
F5 + heat setting and acoustic signal	There is a hot pan in the area of the control panel. There is a risk that the electronics will overheat.	Remove the pan. The fault display goes out shortly afterwards. You can continue to cook.
F5 and acoustic signal	There is a hot pan in the area of the control panel. To protect the electronics, the hotplate has been switched off.	Remove the pan. Wait for a few seconds. Touch any control. If the fault display goes out, you can continue to cook.
F1/F6	The hotplate has overheated and switched itself off to protect the work surface.	Wait until the electronics have cooled down sufficiently and switch the hotplate on again.
F0	You cannot activate the settings transfer function	Check the fault display by touching any control. You can cook as usual without using the settings transfer function. Contact the technical after-sales service.
F9	You cannot activate the FlexPlus cooking zone	Check the fault display by touching any control. You can use the remaining hotplates to cook as usual. Contact the technical after-sales service.
F8	The hotplate was operating for an extended period without interruption.	The automatic safety switch-off function has been activated. See section
E9000 E90 10	The supply voltage is faulty; outside of the normal operating range.	Contact your electricity provider.
U400	The hob is not connected properly	Disconnect the hob from the power supply. Ensure that it has been connected in accordance with the circuit diagram.
dE	The demo mode is activated	Disconnect the hob from the power supply. Wait 30 seconds and reconnect it. Touch any touch control in the next three minutes. The demo mode is deactivated.

Do not place hot pans on the control panel.

Notes

- If **E** appears in the display, the sensor for the relevant hotplate must be pressed and held in order to read the fault code.
- If the fault code is not listed in the table, disconnect the hob from the power supply, wait 30 seconds and connect it again. If the display appears again, contact technical after-sales and tell them the precise fault code.

Customer service

Our after-sales service is there for you if your appliance needs to be repaired. We will always find an appropriate solution, also in order to avoid after-sales personnel having to make unnecessary visits.

E number and FD number

Please quote the E number (product number) and the FD number (production number) of your appliance when contacting the after-sales service.

The rating plate bearing these numbers can be found:

- On the appliance certificate.
- On the lower section of the hob.

The E-number can also be found on the glass surface of the hob. You can check the customer index (KI) and FD number by going to the basic settings. Look up section → *"Basic settings"* for this.

Please note that a visit from an after-sales service engineer is not free of charge in the event of misuse of the appliance, even during the warranty period.

Please find the contact data of all countries in the enclosed customer service list.

To book an engineer visit and product advice

GB 0344 892 8979

Calls charged at local or mobile rate.

IE 01450 2655

0.03 € per minute at peak. Off peak 0.0088 € per minute.

Rely on the professionalism of the manufacturer. You can therefore be sure that the repair is carried out by trained service technicians who carry original spare parts for your appliances.

Test dishes

This table has been produced for test institutes to facilitate the testing of our appliances.

The data in the table refers to our Schulte-Ufer cookware accessories (4 piece cookware set for the HEZ 390042 induction hob) with the following measurements:

- Saucepan Ø 16 cm, 1.2 l for hotplates of Ø 14.5 cm
- Pot Ø 16 cm, 1.7 l for hotplates of Ø 14.5 cm
- Pot Ø 22 cm, 4.2 l for hotplates of Ø 18 cm
- Frying pan Ø 24 cm, for hotplates of Ø 18 cm

Test dishes	Cookware	Heat setting	Preheating		Cooking	
			Cooking time (min:sec)	Lid	Heat setting	Lid
Melting chocolate						
Chocolate coating (e.g. Dr. Oetker brand, dark chocolate 55% cocoa, 150 g)	Saucepan, 16 cm diameter	-	-	-	1.5	No
Heating and keeping lentil stew warm						
Lentil stew*						
Initial temperature 20 °C						
Amount: 450 g	Cooking pot, 16 cm diameter	9	1:30 (without stirring)	Yes	1.5	Yes
Amount: 800 g	Saucepan, 22 cm diameter	9	2:30 (without stirring)	Yes	1.5	Yes
Lentil stew from a tin						
E.g lentils with Erasco sausages.						
Initial temperature 20 °C						
Amount: 500 g	Cooking pot, 16 cm diameter	9	Approx. 1:30 (stir after approx. 1 minute)	Yes	1.5	Yes
Amount: 1 kg	Saucepan, 22 cm diameter	9	Approx. 2:30 (stir after approx. 1 minute)	Yes	1.5	Yes
Preparing Béchamel sauce						
Temperature of the milk: 7 °C						
Ingredients: 40 g butter, 40 g flour, 0.5 l milk (3.5% fat content) and a pinch of salt						
1. Melt the butter, stir in the flour and salt, and heat up the mixture.	Saucepan, 16 cm diameter	2	Approx. 6:00	No	-	-
2 Add the milk to the roux and bring to the boil, stirring continuously.		7	Approx. 6:30	No	-	-
3. Once the Béchamel sauce comes to the boil, leave it on the hotplate for a further two minutes, stirring continuously.		-	-	-	2	No

*Recipe in accordance with DIN 44550

**Recipe in accordance with DIN EN 60350-2

Test dishes	Cookware	Heat setting	Preheating		Cooking	
			Cooking time (min:sec)	Lid	Heat setting	Lid
Cooking rice pudding						
Rice pudding, cooked with the lid on Temperature of the milk: 7 °C Heat the milk until it starts to rise up. Set the recommended heat setting and add rice, sugar and salt to the milk. The cooking time, including preheating, is approx. 45 minutes.						
Ingredients: 190 g short-grain rice, 90 g sugar, 750 ml milk (3.5% fat content) and 1 g salt	Cooking pot, 16 cm diameter	8.5	Approx. 5:30	No	3 (stir after 10 minutes)	Yes
Ingredients: 250 g short-grain rice, 120 g sugar, 1 l milk (3.5% fat content) and 1.5 g salt	Saucepan, 22 cm diameter	8.5	Approx. 5:30	No	3 (stir after 10 minutes)	Yes
Rice pudding, cooked without lid Temperature of the milk: 7 °C Add the ingredients to the milk and heat the mixture up while stirring continuously. Once the milk has reached approx. 90 °C, select the recommended heat setting and leave it to simmer on a low heat for approx. 50 minutes.						
Ingredients: 190 g short-grain rice, 90 g sugar, 750 ml milk (3.5% fat content) and 1 g salt	Cooking pot, 16 cm diameter	8.5	Approx. 5:30	No	3	No
Ingredients: 250 g short-grain rice, 120 g sugar, 1 l milk (3.5% fat content) and 1.5 g salt	Saucepan, 22 cm diameter	8.5	Approx. 5:30	No	2.5	No
Cooking rice*						
Water temperature: 20 °C						
Ingredients: 125 g long grain rice, 300 g water and a pinch of salt	Cooking pot, 16 cm diameter	9	Approx. 2:30	Yes	2	Yes
Ingredients: 250 g long grain rice, 600 g water and a pinch of salt	Saucepan, 22 cm diameter	9	Approx. 2:30	Yes	2.5	Yes
Roasting a pork loin						
Initial temperature of the loin: 7 °C						
Amount: 3 pork loins (total weight approx. 300 g, 1 cm thick) and 15 ml sunflower oil	Frying pan, 24 cm diameter	9	Approx. 1:30	No	7	No
Preparing pancakes**						
Amount: 55 ml batter for each pancake	Frying pan, 24 cm diameter	9	Approx. 1:30	No	7	No
Deep-fat frying chips						
Amount: 1.8 l sunflower oil, per portion: 200 g frozen chips (e.g. McCain 123 Original fries)	Saucepan, 22 cm diameter	9	Until the oil temperature reaches 180 °C	No	9	No

*Recipe in accordance with DIN 44550

**Recipe in accordance with DIN EN 60350-2



Robert Bosch Hausgeräte GmbH

Carl-Wery-Straße 34
81739 München, GERMANY

www.bosch-home.com



9001063716
960215(03)