



Register your new Bosch now:  
[www.bosch-home.com/welcome](http://www.bosch-home.com/welcome)



**Washing machine**  
**WAK20210ME**



**BOSCH**

**en** Instruction Manual and Installation Instructions

## Your new washing machine

You have chosen a Bosch washing machine.

Please take a few minutes to read and become familiar with the advantages of your washing machine.

To meet the high quality demands required by Bosch, every washing machine that leaves our factory is carefully checked to ensure that it functions correctly and is in perfect condition.

For more information on our products, accessories, replacement parts and services, see our website [www.bosch-home.com](http://www.bosch-home.com) or contact our after-sales service centres.

If the operating and installation instructions describe different models, any differences will be pointed out at the relevant points in the text.



Read these operating and installation instructions before switching on the washing machine.

## Display rules

### **Warning!**

This combination of symbol and signal word indicates a possibly dangerous situation. Not heeding the warning can cause death or injuries.

### **Caution!**

This signal word indicates a possibly dangerous situation. Not heeding the caution can cause property and/or environmental damage.

### **Note/tip**

Information about the optimum use of the appliance/any other useful information.

### **1. 2. 3. / a) b) c)**





The steps are represented by numbers or letters.

■ / -

Lists are represented by a small box or a dash.

# Contents

 <b>Intended use</b> . . . . .	5	 Easy-Iron . . . . .	18
 <b>Safety instructions</b> . . . . .	6	 <b>Operating the appliance</b> . . . . .	18
Electrical safety . . . . .	6	Preparing the washing machine . . . . .	18
Risk of injury . . . . .	6	Select programme/switch on the appliance . . . . .	18
Safety for children . . . . .	6	Change the programme default settings . . . . .	18
 <b>Environmental protection</b> . . . . .	8	Select additional programme settings . . . . .	19
Packaging/used appliance . . . . .	8	Placing laundry into the drum . . . . .	19
Tips on economical use . . . . .	8	Measure and add detergent and care products . . . . .	19
 <b>Main points in brief</b> . . . . .	9	Start the programme . . . . .	20
 <b>Getting to know the appliance</b> . . . . .	10	Childproof lock . . . . .	20
Washing machine . . . . .	10	Adding laundry . . . . .	21
Control panel . . . . .	11	Changing the programme . . . . .	21
Display panel . . . . .	11	Cancel the programme . . . . .	21
 <b>Laundry</b> . . . . .	12	Programme end during rinse hold . . . . .	21
Prepare the laundry . . . . .	12	Programme end . . . . .	21
Sorting laundry . . . . .	12	Removing laundry/switching off the appliance . . . . .	22
 <b>Detergent</b> . . . . .	13	 <b>Sensors</b> . . . . .	22
Correct selection of detergent . . . . .	13	Automatic load sensing . . . . .	22
Saving energy and detergent . . . . .	13	Unbalanced load detection system . . . . .	22
 <b>Overview of programmes</b> . . . . .	14	VoltCheck . . . . .	22
Programmes on the programme selector . . . . .	14	 <b>Setting the signal</b> . . . . .	23
Starching . . . . .	16	 <b>Cleaning and maintenance</b> . . . . .	24
Dyeing/bleaching . . . . .	16	Machine housing/control panel . . . . .	24
Soaking . . . . .	16	Drum . . . . .	24
 <b>Programme default settings</b> . . . . .	17	Descaling . . . . .	24
Temperature (Temp °C) . . . . .	17	Detergent drawer and housing . . . . .	24
Spin speed (rpm  ) . . . . .	17	Detergent solution pump blocked . . . . .	24
Ready in time (Ready in) . . . . .	17	The drain hose at the siphon is blocked . . . . .	25
 <b>Additional programme settings</b> . . . . .	18	Filter in the water supply blocked . . . . .	25
 SpeedPerfect . . . . .	18		
 EcoPerfect . . . . .	18		

	<b>Faults and what to do about them. . . . .</b>	<b>27</b>
	Emergency release . . . . .	27
	Information on the display panel . . . . .	27
	Faults and what to do about them. . . . .	28
	<b>After-sales service . . . . .</b>	<b>30</b>
	<b>Consumption rates . . . . .</b>	<b>31</b>
	Energy and water consumption, programme duration and residual moisture for the main washing programmes . . . . .	31
	Efficiency test programmes for cotton fabrics. . . . .	32
	<b>Technical data . . . . .</b>	<b>32</b>
	<b>Positioning and connecting. . . . .</b>	<b>33</b>
	Included with the appliance . . . . .	33
	Safety instructions . . . . .	33
	Installation surface. . . . .	34
	Installation on a base or a wooden joist floor . . . . .	34
	Installing the appliance in a kitchenette . . . . .	34
	Removing the transport locks . . . . .	34
	Hose and cable lengths. . . . .	35
	Water inlet . . . . .	35
	Water outlet . . . . .	36
	Levelling . . . . .	37
	Electrical connection . . . . .	38
	Before washing for the first time . . . . .	38
	Transportation . . . . .	39



## Intended use

- For private domestic use only.
- The washing machine is suitable for washing machine-washable fabrics and hand-washable wool in detergent solution.
- To be operated with cold mains water and standard detergents and care products which are suitable for use in washing machines.
- When measuring out the amount of all detergents, additives, care products and cleaning agents, always follow the manufacturer's instructions.
- The washing machine may be used by children over the age of 8 years and by persons with reduced physical, sensory or mental capacity or by persons with a lack of experience or knowledge if they **are supervised** or have been **instructed** by a responsible person. Children must not carry out any cleaning or maintenance work without supervision.
- Keep children under the age of 3 years away from the washing machine.
- This appliance is intended for use up to a maximum height of 4000 metres above sea level.
- Keep pets away from the washing machine.

**Before operating the appliance:** Read the installation and operating instructions and all other information enclosed with the washing machine, and use the machine accordingly. Retain the documents for subsequent use or for subsequent owners.

## Safety instructions

### Electrical safety

#### Warning

#### **Danger of death!**

There is a risk of electric shock if you touch live components.

- Never touch or hold the mains plug with wet hands.
- Only pull out the mains cable by the plug and never by the cable, as this could damage it.

### Risk of injury

#### Warning

#### **Risk of injury!**

- When the washing machine is lifted by its protruding parts (e.g. the washing machine door), the components may break off and cause injuries. Do not lift the washing machine by protruding parts.
- If you climb on the washing machine, the worktop may break and cause injuries. Do not climb onto the washing machine.
- If you lean on the washing machine door when it is open, the washing machine may tip over and cause injuries. Do not lean on the washing machine door when it is open.

- Reaching into the drum when it is turning can cause injuries to hands. Do not reach into the drum when it is turning. Wait until the drum has stopped turning.

#### Warning

#### **Risk of scalding!**

When you are washing at high temperatures, there is a risk of scalding if you come into contact with hot water e.g. if hot water is being drained into a wash basin.

Do not reach into the hot detergent solution.

### Safety for children

#### Warning

#### **Danger of death!**

If children play with the washing machine, they may get into life-threatening situations or injure themselves.

- Do not leave children unattended near the washing machine.
- Do not let children play with the washing machine.

**⚠ Warning****Danger of death!**

Children may lock themselves in appliances, putting their lives at risk.

For appliances that have reached the end of their service life:

- Disconnect the mains plug.
- Cut through the mains cable and remove it, along with plug.
- Destroy the lock on the washing machine door.

**⚠ Warning****Risk of suffocation!**

Children may become wrapped in packaging/film or packing parts if allowed to play with them, or they may pull them over their heads and suffocate. Keep packaging, film and packaging parts out of the reach of children.

**⚠ Warning****Risk of poisoning!**

Detergents and care products may be poisonous if consumed.

Keep detergents and care products out of the reach of children.

**⚠ Warning****Eye/skin irritation!**

Detergents and care products may cause irritation if they come into contact with the eyes or skin.

Keep detergents and care products out of the reach of children.

**⚠ Warning****Risk of injury!**

When you wash at high temperatures, the glass in the washing machine door gets hot.

Do not let children touch the hot washing machine door.



## Environmental protection

### Packaging/used appliance



Dispose of packaging in an environmentally-responsible manner.

This appliance is labelled in accordance with European Directive 2012/19/EU concerning used electrical and electronic appliances (waste electrical and electronic equipment - WEEE).

The guideline determines the framework for the return and recycling of used appliances as applicable throughout the EU.









### Tips on economical use

- Always fill the appliance with the maximum amount of laundry for the relevant programme.  
Overview of programmes  
→ *Page 14*
- Wash normally soiled laundry without a prewash.
- Save energy and detergent when washing lightly and normally soiled laundry. → *Page 13*
- **Energy-saving mode:** The display panel lighting goes out after a few minutes and **Start** flashes. To activate the lighting, press any button.  
Energy-saving mode is not activated if a programme is running.
- If the laundry is subsequently dried in a tumble dryer, select the spin speed according to the tumble dryer manufacturer's instructions.

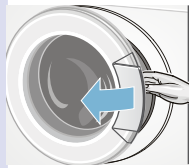
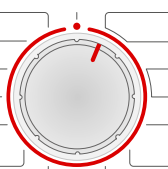

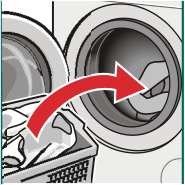
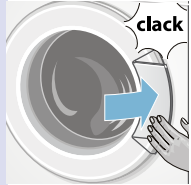
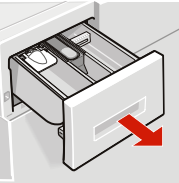
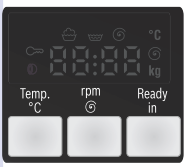

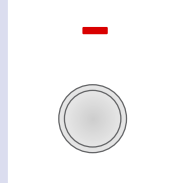
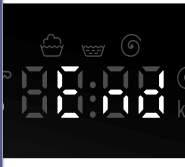
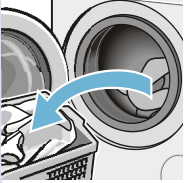
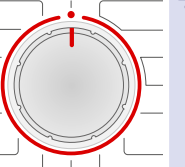
## Main points in brief

1				
	Connect the mains plug.	Turn on the water tap.	Sort the laundry.	Open the door.
2				
	Select a programme e.g. <b>Cottons</b> .	Observe the maximum load on the display panel.	Load the laundry .	Close the washing machine door.
3				
	Add detergent.	Change the programme default settings, if necessary.	Select additional settings, if necessary.	Start the programme.
4				
	Programme end	Open the washing machine door and remove the laundry.	Set the programme selector to ●.	Turn off the water tap (for models without Aqua-Stop).

## Getting to know the appliance

### Washing machine

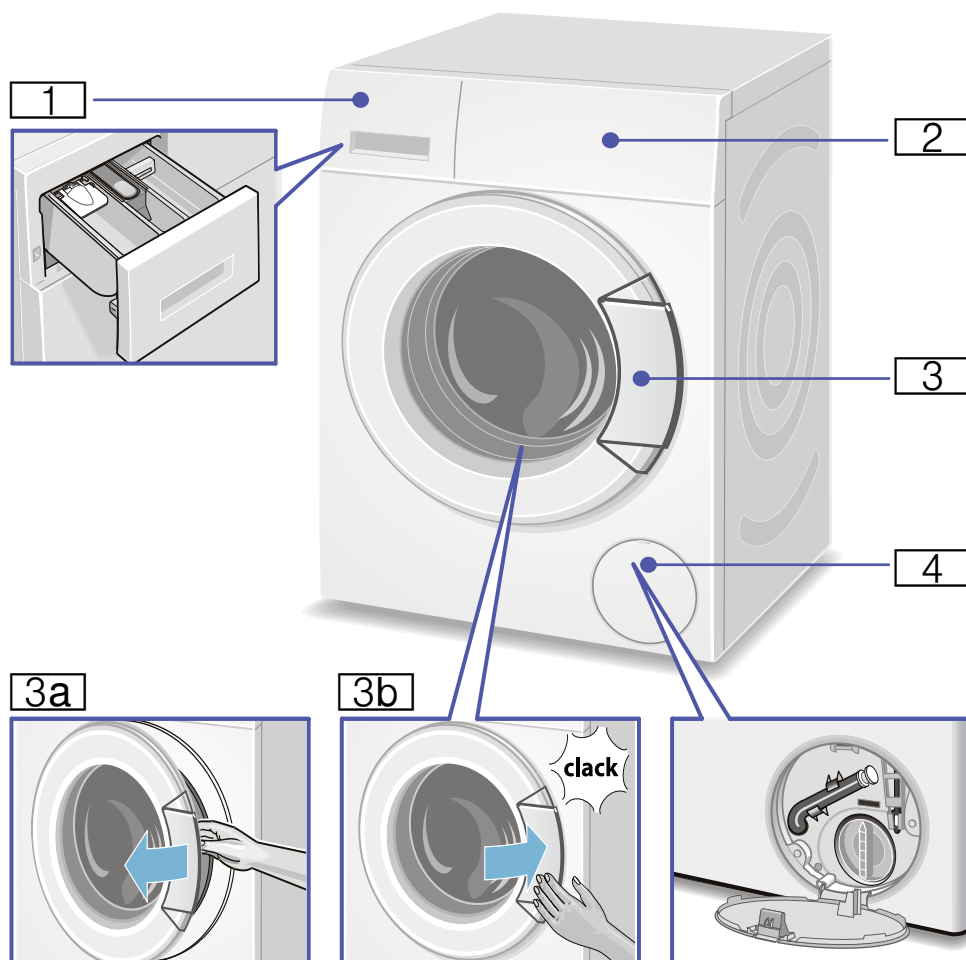

**1** Detergent drawer → *Page 19*

**2** Controls/display elements

**3** Washing machine door with window handle

**3a** Open the washing machine door

**3b** Close the door

**4** Service flap

## Control panel

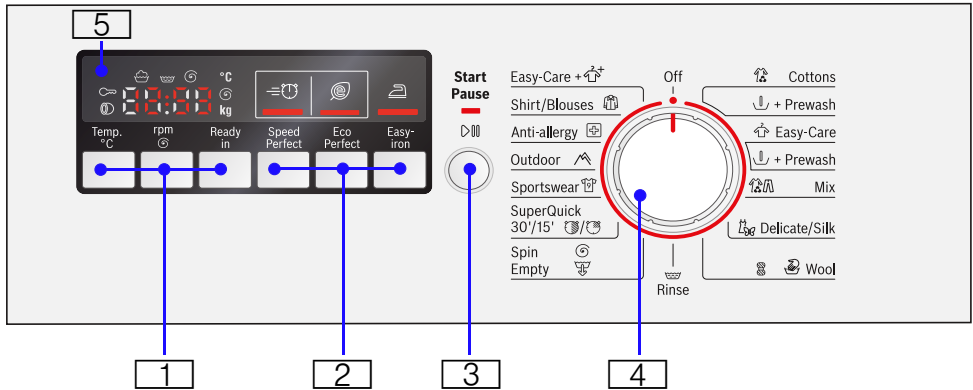

**1** Temp. °C (temperature), rpm (spin speed), **Ready in** time for changing the programme default settings

**2** Speed Perfect, Eco Perfect, Easy Iron additional programme settings

**3** Start/Pause for starting, interrupting (adding laundry) and cancelling a programme

**4** Programme selector for selecting a programme and for switching the machine on and off

**5** Display panel for settings and information

## Display panel

### Settings for the selected programme

Cold - 90 °C	Temperature	Cold
-- ...1000**	Spin speed; ** max. speed depends on the model	In rpm (rotations per minute); -- -- = Rinse hold (without final spin)
1:30	Programme duration	Depends on the programme selection in h:min (hours:minutes)
1 - 24 h	Ready in	Programmes ends after ... h (h = hours)
8.0 kg	Max. load	

### Status indicators for the programme progress (programme sequence):

☹️🪣🌀 End: Wash, rinse, spin, programme duration or end

🚪 : Open the washing machine door, add laundry

🔒 : Childproof lock



## Laundry

### Prepare the laundry

#### Caution!

#### Damage to the appliance/fabrics

Foreign objects (e.g. coins, paperclips, needles, nails) may damage the laundry or components in the washing machine.

You should therefore note the following tips when preparing your laundry:

- Empty any pockets.

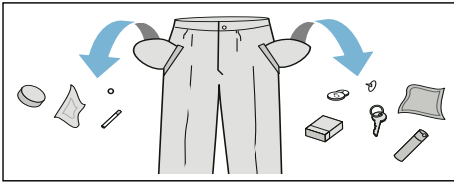

- Look out for metal items (paperclips, etc.) and remove them.
- Wash delicates in a laundry bag (tights, underwired bras, etc.).
- Close any zips; button up any cover buttons.
- Brush sand out of pockets and collars.
- Remove curtain fittings or place curtains in a laundry bag.

### Sorting laundry

Sort your laundry according to the care instructions and manufacturer's information on the care labels:

- Type of fabric/fibre
- Colour
  - Note:** Laundry can discolour or not be cleaned correctly. Wash white and coloured laundry separately. Wash new bright fabrics separately the first time you wash them.
- Soiling
  - Wash laundry with the same level of soiling together.

You can find examples of levels of soiling on → *Page 13*

- **Light:** Do not prewash, select the Speed Perfect setting if necessary
- **Normal**
- **Heavy:** Load less laundry, select a programme with prewash
- **Stains:** Remove/pretreat stains while they are fresh. First, dab the stain with soapy water/do not rub. Then wash the items of laundry with the appropriate programme. Stubborn/dried-in stains can sometimes only be removed with several washes.
- Symbols on the care labels
  - The numbers in the symbols indicate the maximum washing temperature which may be used.
  - : Suitable for a normal washing process; e.g. **Cottons** programme
  - : A gentle washing process is required; e.g. **Easy-Care** programme
  - : An especially gentle washing process is required; e.g. **Delicate/Silk** programme
  - : Suitable for washing by hand; e.g. **Wool** programme
  - : Do not wash the laundry in the machine.

## Detergent

### Correct selection of detergent

The care label is crucial for selecting the correct detergent, temperature and treatment of the laundry. → See also [www.sartex.ch](http://www.sartex.ch)

If you visit [www.cleanright.eu](http://www.cleanright.eu), you will find further information on detergents, care products and cleaning agents for domestic use.

- **Standard detergent with optical brighteners**  
Suitable for boil-washable white laundry made from linen or cotton  
Programme: Cottons/  
cold - max. 90 °C
- **Detergent for colours without bleach or optical brighteners**  
Suitable for coloured laundry made from linen or cotton  
Programme: Cottons/  
cold - max. 60 °C
- **Detergent for colours/delicates without optical brighteners**  
Suitable for coloured laundry made from easy-care fibres, synthetic fibres  
Programme: Easy-Care/  
cold - max. 60 °C
- **Detergent for delicates**  
Suitable for delicate, fine fabrics, silk or viscose  
Programme: Delicate/Silk/  
cold - max. 40 °C
- **Detergent for woollens**  
Suitable for wool  
Wool programme/  
cold - max. 40 °C

### Saving energy and detergent





















For light and normal soiling, you can save energy (lower washing temperature) and detergent.

















Saving	Soiling/note
 <p>Reduced temperature and detergent quantity as per the recommended dosage</p>	<p><b>Light</b> No visible dirt or stains. Clothing has taken on some body odour, e.g.:</p> <ul style="list-style-type: none"> <li>■ Light summer/sports clothing (worn for a few hours)</li> <li>■ T-shirts, shirts, blouses (worn for up to one day)</li> <li>■ Guest bed linen and hand towels (used for one day)</li> </ul>
	<p><b>Normal</b> Visible dirt or a few light stains, e.g.:</p> <ul style="list-style-type: none"> <li>■ T-shirts, shirts, blouses (sweat soaked, worn a few times)</li> <li>■ Towels, bedding (used for up to one week)</li> </ul>
	<p><b>Heavy</b> Dirt and/or stains clearly visible, e.g. tea towels, baby items, work clothing</p>
<p>Temperature as per the care label and detergent quantity as per the recommended dosage for heavy soiling</p>	





**Note:** When measuring the amount of all detergents/additives/care products and cleaning agents, please always check the manufacturer's instructions and information. → Page 19

## Overview of programmes

### Programmes on the programme selector

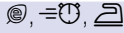
Programme/type of laundry/information	Settings
<p><b>Name of programme</b></p> <p>Brief explanation of the programme and for which fabrics it is suitable.</p>	<p>Max. load;</p> <p>* reduced load at  Speed Perfect setting</p> <p>Temperature that can be selected</p> <p>Spin speed that can be selected;</p> <p>** Max. spin speed, depending on the model</p> <p>Possible programme settings</p>
<p> <b>Cotton</b></p> <p>Hard-wearing fabrics, boil-resistant fabrics made of cotton or linen</p> <p>Cottons  + <b>Prewash</b>: Programme with pre-wash; divide the detergent between compartments <b>I</b> and <b>II</b></p> <p><b>Note:</b> The  Speed Perfect setting is suitable as a short programme for lightly soiled laundry.</p>	<p>Max. 8 kg/5* kg</p> <p>Cold - 90 °C</p> <p>- - - ... 1000** rpm</p> <p>, , </p>
<p> <b>Easy-Care</b></p> <p>Textiles made of synthetic materials or blended fabrics</p> <p>Easy-Care  + <b>Prewash</b>: Programme with prewash; divide the detergent between compartments <b>I</b> and <b>II</b></p>	<p>Max. 4 kg</p> <p>Cold - 60 °C</p> <p>- - - ... 1000 rpm</p> <p>, , </p>
<p> <b>Mix</b></p> <p>A mixed load of fabrics made of cotton and synthetic fabrics</p>	<p>Max. 3.5 kg</p> <p>Cold - 40 °C</p> <p>- - - ... 1000** rpm</p> <p>, , </p>
<p> <b>Delicate/Silk</b></p> <p>For delicate, washable fabrics, e.g. made of silk, satin, synthetic fibres or blended fabrics (e.g. silk blouses, silk scarves)</p> <p><b>Note:</b> Use a detergent which is suitable for machine washing delicates or silk.</p>	<p>Max. 2 kg</p> <p>Cold - 40 °C</p> <p>- - - ... 800 rpm</p> <p>, , </p>

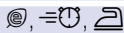
Programme/type of laundry/information	Settings
<p> <b>Wool</b></p> <p>Hand or machine-washable fabrics made of wool or that contain wool; particularly gentle wash programme to prevent shrinkage of laundry, with longer programme breaks (fabrics rest in the detergent solution)</p> <p><b>Notes</b></p> <ul style="list-style-type: none"> <li>■ Wool is of animal origin, e.g.: Angora, alpaca, llama, sheep.</li> <li>■ Use a detergent which is suitable for machine washing wool.</li> </ul>	<p>Max. 2 kg</p> <p>Cold - 40 °C</p> <p>--- ... 800 rpm</p> <p>-</p>
<p> <b>Rinse</b></p> <p>Extra rinse with spin</p>	<p>Max. 8 kg</p> <p>-</p> <p>--- ... 1000** rpm</p> <p></p>
<p> <b>Spin/</b>  <b>Empty</b></p> <p>Extra spin with speed that can be selected</p> <p>If only the "Empty" cycle is required, set the spin speed to ---.</p>	<p>Max. 8 kg</p> <p>-</p> <p>--- ... 1000** rpm</p> <p></p>
<p> <b>SuperQuick 30'/15'</b></p> <p>Extra-short programme of approx. 30/15' minutes, suitable for small items of lightly soiled laundry</p> <p><b>Note:</b> The <b>SuperQuick 15'</b> programme is run for the <b>speedPerfect</b>  setting</p>	<p>Max. 3.5 kg/2 kg</p> <p>Cold - 40 °C</p> <p>--- ... 1000 rpm</p> <p></p>
<p> <b>Sportswear</b></p> <p>For fabrics made of microfibres for sports and leisure</p> <p><b>Notes</b></p> <ul style="list-style-type: none"> <li>■ Laundry must not be treated with fabric softener.</li> <li>■ Before washing, clean the detergent drawer thoroughly (all compartments) to remove fabric softener residue.</li> </ul>	<p>Max. 2 kg</p> <p>Cold - 40 °C</p> <p>--- ... 800 rpm</p> <p> ,  , </p>
<p> <b>Outdoor</b></p> <p>Weatherproof and outdoor clothing with a membrane coating and water-repellent fabrics</p> <p><b>Notes</b></p> <ul style="list-style-type: none"> <li>■ Use special detergent suitable for machine washing; add the correct dosage to compartment <b>II</b> in accordance with the manufacturer's instructions.</li> <li>■ Laundry must not be treated with fabric softener.</li> <li>■ Before washing, clean the detergent drawer thoroughly (all compartments) to remove fabric softener residue.</li> </ul>	<p>Max. 2 kg</p> <p>Cold - 40 °C</p> <p>--- ... 800 rpm</p> <p> ,  , </p>

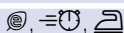
Programme/type of laundry/information	Settings
 <b>Anti-allergy</b> Hard-wearing textiles. <b>Note:</b> Longer washing and rinsing at a higher water level for particularly sensitive skin	Max. 7.5 kg/5* kg Cold - 60 °C - - - ... 1000** rpm 
 <b>Shirt/Blouses</b> Non-iron shirts/blouses made of cotton, linen, synthetic fibres or blended fabrics <b>Note:</b> Use the Delicate/Silk programme to wash shirts/blouses made of silk/delicate fabrics.	Max. 2 kg Cold - 60 °C - - - ... 800 rpm 
<b>Easy-Care Plus</b> +  Dark fabrics made of cotton and dark easy-care fabrics Turn laundry inside-out before washing.	Max. 3.5 kg Cold - 40 °C - - - ... 1000 rpm 

## Starching

**Note:** Laundry should not be treated with fabric softener.



Liquid starch can be used to stiffen fabrics particularly in the Rinse and Cottons programmes. Measure starch into compartment  in accordance with the manufacturer's instructions (clean first if necessary).



## Dyeing/bleaching

Dye should only be used in normal household quantities. Salt may damage stainless steel. Always follow the dye manufacturer's instructions.

Do **not** use the washing machine to bleach clothes.

## Soaking

1. Pour soaking agent/detergent into compartment **II** in accordance with the manufacturer's instructions.
2. Turn the programme selector to  **Cottons 30 °C** programme.
3. Press **Start/Pause** .

4. After approx. ten minutes, press **Start/Pause** .
5. After the required soaking time, press **Start/pause**  again to continue or change the programme.

### Notes

- Load laundry of the same colour.
- No additional detergent is required; the soaking solution is used for washing.



## **P+** Programme default settings

The temperature, spin speed and programme duration ("Ready in" time) for all programmes are preset at the factory.

These are displayed in the display panel after selecting the programme.

You can change the default settings as follows.

### Temperature (Temp °C)

Depending on the programme progress, you can change the preset temperature (in °C) before and during the programme.

To do this, repeatedly select the corresponding button until the required setting is displayed.

The maximum temperature that can be set depends on the programme which has been selected.

Overview of programmes → *Page 14*

### Spin speed (rpm )

Depending on the programme progress, you can change the spin speed (in rpm; rotations per minute) before and during the programme.

To do this, repeatedly select the corresponding button until the required setting is displayed.

Setting – – –  : Rinse hold = without final spin, the laundry remains in the water after the final rinse.

You can select "Rinse hold" to prevent creasing if the laundry will not be taken out of the washing machine immediately after the programme has ended.

The maximum speed that can be set depends on the model and programme that have been selected.

Overview of programmes → *Page 14*

### Ready in time (Ready in)

When you select the programme, the relevant programme duration is displayed.

The programme duration is automatically adjusted when the programme is running. Changes to the programme default settings or programme settings also change the programme duration.

Before starting the programme, the programme end ("Ready in" time) can be preselected in increments of one hour (h = hours) up to a maximum of 24 hours.



To do this, repeatedly select the corresponding button until the required setting is displayed.

**Note:** The programme duration is included in the selected "Ready in" time.



After the start, the preselected time e.g. **8 h** is displayed and the time counts down to the start of the wash programme. The programme duration is then displayed, e.g. **2:30** (hours:minutes).

#### Changing the preselected time:

You can change the preselected time after the start of the programme as follows:

1. Press Start/Pause 
2. Press the "Ready in" button repeatedly until the required number of hours is displayed.
3. Press the **Start/Pause**  button.

#### Adding laundry while the preselected time continues running:

1. Press Start/Pause 
2. The symbols **YES** and  light up on the display panel. The washing machine door can be opened and laundry can be added.
3. Close the washing machine door.

**en** Additional programme settings

4. Press the **Start/Pause**  button. The preselected time continues to run.

---

## **P+** Additional programme settings

### **SpeedPerfect**

For washing in a shorter time with a washing result comparable to that of the standard programme.

**Note:** Do not exceed the maximum load.

Overview of programmes → *Page 14*

### **EcoPerfect**

For saving energy with a washing result comparable to that of the standard programme.

### **Easy-Iron**

Special spin sequence with subsequent fluffing. Gentle final spin – residual moisture in the laundry slightly increased.

---

## **Operating the appliance**

### **Preparing the washing machine**

**Note:** The washing machine **must be correctly installed** and **connected**.

From → *Page 33*

1. Connect the mains plug.
2. Turn on the water tap.

3. Open the door.
4. Check that the drum is completely drained. Drain if necessary.

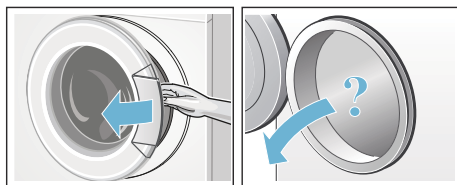

### **Select programme/switch on the appliance**

**Note:** If you have activated the childproof lock, you must first deactivate it before you can set a programme.  
→ *Page 20*

Use the programme selector to select the required programme. Can be turned in either direction.

The machine is switched on.

The display panel shows the following information consecutively for the selected programme:

- The programme duration,
- The preset temperature,
- The preset spin speed and
- The maximum load.

### **Change the programme default settings**

You can use the default settings or change them.

To do this, repeatedly select the corresponding button until the required setting is displayed.

The settings are activated without needing to be confirmed.

They are not saved when the appliance is switched off.

Programme default settings → *Page 17*

Overview of programmes from  
→ *Page 14*

## Select additional programme settings

By selecting additional settings, you can better adapt the washing process to your items of laundry.

The settings can be selected or deselected depending on the programme progress.

The indicator lamp for the button lights up if a setting is active.

The settings are not saved when the appliance is switched off.

Additional settings → *Page 18*

Overview of programmes from  
→ *Page 14*

## Placing laundry into the drum

### **Warning** **Danger of death!**

Items of laundry pretreated with cleaning agents that contain solvents, e.g. stain remover/cleaning solvent, may cause an explosion after being loaded into the washing machine. Hand-rinse items of laundry thoroughly beforehand.

### Notes

- Mix items of laundry of varying sizes. Laundry items of different sizes distribute themselves better during the spin cycle. Individual items of laundry may lead to imbalances.
  - Observe the specified maximum load. Overfilling has a negative impact on the washing result and promotes creasing.
1. Place presorted items of laundry unfolded in the washing drum.

2. Make sure that no items of laundry are trapped between the washing machine door and the rubber seal, and close the door.

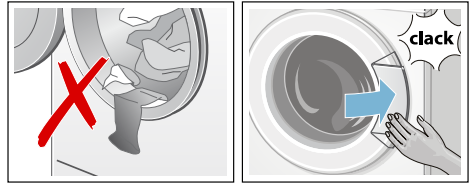

The Start button indicator lamp flashes and the programme settings continue to be displayed on the display panel one after another. It is possible to change the settings.

## Measure and add detergent and care products

### Caution!

#### Damage to the appliance

Cleaning agents and agents for pretreating laundry (e.g. stain removers, prewash sprays, etc.) may cause damage if they come into contact with the surfaces of the washing machine. Do not allow these agents to come into contact with the surfaces of the washing machine. If necessary, immediately wipe away spray residue and other residues/droplets with a damp cloth.

### Measuring

Measure the detergent and care products according to:

- Water hardness; ask your water supply company
- The manufacturer's instructions on the packaging
- The amount of laundry
- Soiling → *Page 13*

## Filling

### **Warning** **Eye/skin irritation!**

Detergent and care products may spray out if the detergent drawer is opened while the machine is in operation. Open the drawer carefully. Rinse eyes or skin thoroughly if they come into contact with detergent/care products. If swallowed accidentally, seek medical advice.

**Note:** Dilute viscous fabric softener and fabric conditioner with water; this prevents blockages.

Pour the detergent and care products into the appropriate compartments:

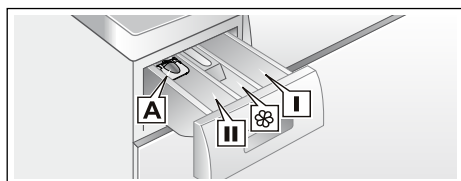

Measuring aid <b>A</b>	For liquid detergent
Compartment <b>II</b>	Detergent for the main wash, water softener, bleach, stain remover
Compartment 	Fabric softener, starch Do not exceed the <b>max.</b>
Compartment <b>I</b>	Detergent for prewash

1. Pull out the detergent drawer as far as possible.
2. Add detergent and/or care products.
3. Close the detergent drawer.

### **Measuring aid\* for liquid detergent**

\*depending on the model

Position the measuring aid for measuring the correct amount of liquid detergent:

1. Pull out the detergent drawer. Press down the insert and fully remove the drawer.
2. Slide the measuring aid forwards, fold it down and click it into place.
3. Reinsert the drawer.

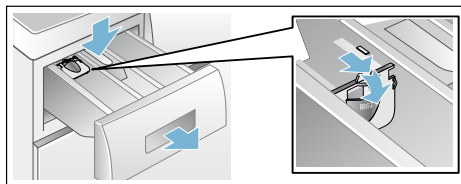

**Note:** Do not use the measuring aid for gel detergents and washing powder, or for programmes with prewash or when "Ready in" time is selected.

**For models without a measuring aid,** pour the liquid detergent into the appropriate dispenser and place it in the drum.

## Start the programme

Select the **Start/Pause**  button. The indicator lamp lights up and the programme starts.

During the programme, the display panel shows the "Ready in" time or, after starting the wash programme, the programme duration and the symbols for the programme progress.



→ Page 11

**Note:** If you want to lock the programme to prevent it from being inadvertently adjusted, you can select the childproof lock as follows.

## Childproof lock

You can lock the washing machine to prevent the functions you have set from being changed inadvertently. To do this, activate the childproof lock after starting the programme.

To **activate/deactivate** the childproof lock, press and hold Start/Pause for approx. five seconds. The  symbol appears in the display panel.

-  lights up: The childproof lock is active.
-  flashes: The childproof lock is active and the programme selector was adjusted. To prevent the programme from stopping, turn the programme selector back to the original programme. The symbol lights up again.

**Note:** The childproof lock can remain activated until you wish to start the next programme, even after switching off the machine.

You must then deactivate the childproof lock before starting the programme and activate it again as necessary once the programme has started.

## Adding laundry



After starting the programme, you can add or remove laundry as required.

To do this, press the Start/**Pause**  button.

The Start/Reload  indicator lamp flashes and the machine checks whether it is possible to add laundry.

**Note:** Do not leave the washing machine door open for too long when adding laundry as water from the laundry may leak out.

If the display panel shows:



- **Both** the **YES** and  symbols lit up, it is possible to add laundry.
- A flashing **NO** symbol, wait until **YES** and  light up.  
Do not open the door until **both** the **YES** and the  symbols are lit.
- A flashing **NO** symbol, it is not possible to add laundry.  
For safety reasons, the washing machine door remains locked when

the water level or temperature is high, or while the drum is rotating, and it is not possible to add laundry.

**To continue the programme, press** the **Start/Pause**  button. The programme continues automatically.



## Changing the programme

If you have started the wrong programme by mistake, you can change the programme as follows:



1. Press Start/**Pause** .
2. Select the other programme.
3. Press **Start/Pause** . The new programme starts from the beginning.

## Cancel the programme

Programmes at high temperatures:



1. Press Start/**Pause** .
2. To cool the laundry: Select  **Rinse**.
3. Press **Start/Pause** .

For programmes at low temperatures:

1. Press Start/**Pause** .
2. Select  **Spin** or  **Empty**.
3. Press **Start/Pause** .

## Programme end during rinse hold

– – –  appears on the display panel and the Start/Reload button indicator lamp flashes.

To end the programme, set the programme selector to  Spin /  Empty or select a spin speed. Then press the **Start/Pause**  button.

## Programme end

**End** appears on the display panel and the Start/Pause button indicator lamp is off.

If the  symbol appears on the display panel, the washing machine has

detected too much foam during the wash programme and automatically switched on a rinse cycle to remove the foam.

**Note:** Add less detergent for the next washing cycle with the same load.

## Removing laundry/switching off the appliance

1. Open the washing machine door and remove the laundry.
2. Set the programme selector to **Off**. The appliance is switched off.
3. Turn off the water tap.

**Note:** Not required for Aqua-Stop models.

### Notes

- Do not leave any items of laundry in the drum. They may shrink in the next wash or discolour another item.
- Remove any foreign objects from the drum and the rubber seal – risk of rusting.

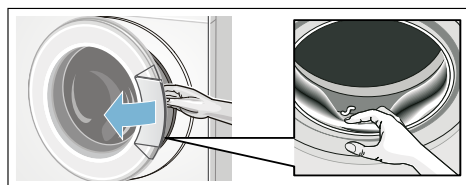

- Leave the washing machine door and detergent drawer open so that any residual water can dry away.
- Always wait for the end of the programme, otherwise the appliance may still be locked. Then switch on the appliance and wait for it to unlock.
- If the display panel goes off at the end of a programme, energy-saving mode is active. To activate the panel, press any button.

## Sensors

### Automatic load sensing

The automatic load sensing function adapts the water consumption ideally to each programme depending on the type of fabric and the load.

### Unbalanced load detection system

The automatic unbalanced load detection system detects imbalances and ensures even distribution of the laundry by repeatedly starting and stopping drum spinning.

If the laundry is extremely unevenly distributed, the speed is reduced or the spin cycle is not performed for safety reasons.

**Note:** Place large and small items of laundry evenly in the drum. → *Page 28*

### VoltCheck

The automatic voltage control system detects that the voltage has fallen to an impermissible value. The colon in the "Ready in" display flashes on the display panel. → *Page 11*

If the supply voltage is stable again, the colon in the "Ready in" display will stop flashing.

However, if the fall in voltage causes the programme to be extended, the dot flashes in the "Ready in" display.

## Setting the signal

### 1. Activate the setting mode for the signal volume

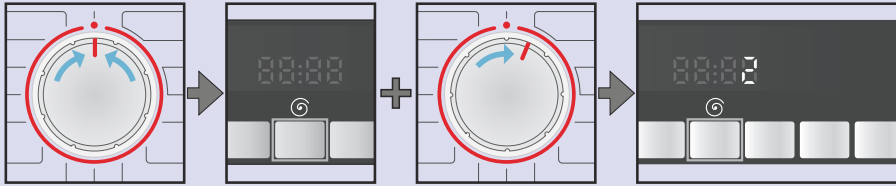

Set to ●.

Press and hold the  button **and** turn one position to the right.

Press and hold the button for approx. five seconds until the display elements light up. Setting mode is activated.

### 2. Set the volume for the button signals (depending on the model)

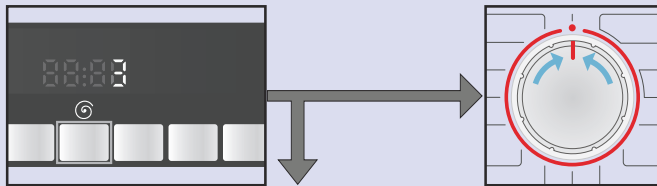

Press the button repeatedly until the desired volume is reached.

Go to point 3 or

Set to ● to exit the setting mode for the signal volume.



### 3. Set the volume for the information signals



Turn the dial one position to the right.

Press the button repeatedly until the desired volume is reached.

Set to ● to exit the setting mode for the signal volume.



## Cleaning and maintenance

### Warning

#### Danger of death!

There is a risk of electric shock if you touch live components. Switch off the appliance and unplug the mains plug.

### Warning

#### Risk of poisoning!

Toxic vapours can be produced by cleaning agents that contain solvents, e.g. cleaning solvent. Do not use cleaning agents that contain solvents.

### Caution!

#### Damage to the appliance

Cleaning agents that contain solvents, e.g. cleaning solvent, can damage surfaces and components in the machine. Do not use cleaning agents that contain solvents.

## Machine housing/control panel

- Wipe the housing and the control panel with a soft, damp cloth.
- Remove the detergent residue immediately.
- Do not clean with a water jet.

## Drum

Use chlorine-free cleaning agents and not steel wool.

## Descaling

Descaling should not be necessary if the detergent is measured out correctly. However, if it is required, follow the manufacturer's instructions for the descaling agent. Suitable descalers can

be obtained via our website or from our after-sales service.

## Detergent drawer and housing

If the washing machine contains detergent or fabric softener residues:

1. Pull out the detergent drawer. Press down the insert and fully remove the drawer.
2. To remove the insert: Push the insert upwards from below with your finger.

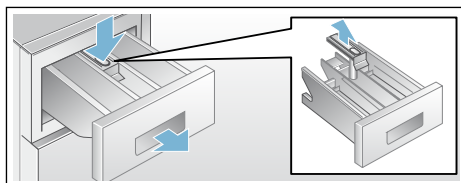

3. Clean the detergent dispenser tray and insert with water and a brush, and dry it. Clean the inside of the housing as well.
4. Fit the insert and lock it in place (push the cylinder onto the guide pin).
5. Push in the detergent drawer.

**Note:** Leave the detergent drawer open so that any residual water can evaporate.

## Detergent solution pump blocked

### Warning

#### Risk of scalding!

When you wash at high temperatures, the water gets very hot. If you come into contact with the hot water, you may be scalded.

Allow the water to cool down.

1. Turn off the water tap so that no more water can flow in and has to be drained via the drain pump.
2. Switch off the appliance. Disconnect the mains plug.



3. Open and remove the service flap.

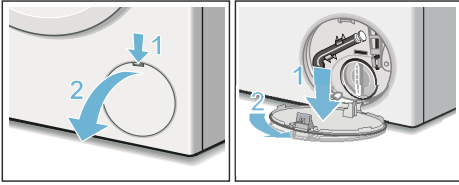

4. Take the drain hose out of the retainer.  
Remove the sealing cap, allow the detergent solution to flow out into a suitable container.  
Replace the sealing cap and place the drainage hose in the retainer.

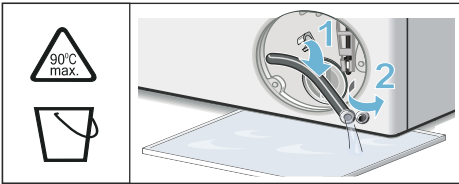

5. Carefully unscrew the pump cover, residual water may leak out. Clean the interior, pump cover thread and pump housing. The impeller in the detergent solution pump must be able to rotate. Refit the pump cover and screw it on tightly. The handle must be in a vertical position.

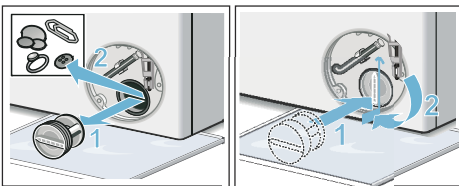

6. Place the service flap back on, lock it into place, and close it.

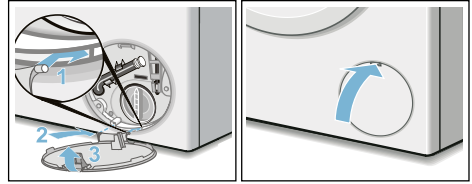

**Note:** To prevent unused detergent from flowing straight into the drain during the next wash: Pour 1 litre of water into compartment II and start the  **Empty** programme.

### The drain hose at the siphon is blocked

1. Switch off the appliance. Disconnect the mains plug.
2. Loosen the hose clamp. Carefully remove the drain hose, residual water may leak out.
3. Clean the drainage hose and siphon connecting piece.

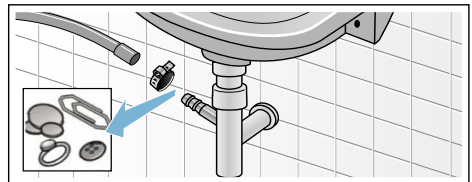

4. Reattach the drainage hose and secure the connection using the hose clamp.

### Filter in the water supply blocked

For this, first reduce the water pressure in the supply hose:

1. Turn off the water tap.
2. Select any programme (except Rinse//Spin/Drain).

**en** Cleaning and maintenance

3. Press **Start/Reload** . Allow the programme to run for approximately 40 seconds.
4. Set the programme selector to **Off**. Disconnect the mains plug.
5. Clean the filter on the water tap:  
Remove the hose from the water tap.  
Clean the filter with a small brush.

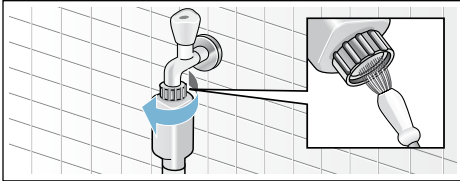

6. For standard and Aqua-Secure models, clean the filter on the rear of the appliance:  
Remove the hose from the rear of the appliance,  
Remove the filter using pliers and clean the filter.

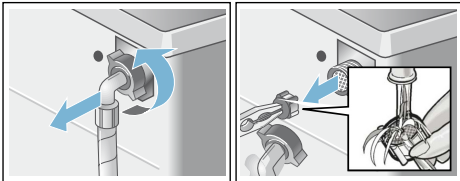

7. Connect the hose and check for leaks.

## **Faults and what to do about them.**

### **Emergency release**

e.g. in the event of a power cut

The programme will continue running when the power supply has been restored.

However, if the laundry has to be removed, the washing machine door can be opened as follows:

#### **Warning**

##### **Risk of scalding!**

When you are washing at high temperatures, there is a risk of scalding if you come into contact with detergent solution and laundry.

If possible, leave it to cool down.

#### **Warning**

##### **Risk of injury!**

You may injure your hands if you reach into the drum while it is turning.

Do not reach into the drum when it is turning.

Wait until the drum has stopped turning.

#### **Caution!** **Water damage**



Any escaping water may cause water damage.

Do not open the washing machine door if water can be seen through the glass.

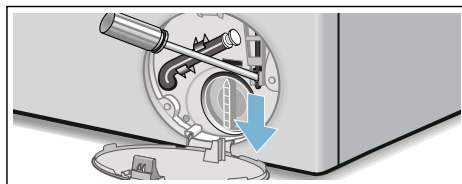

1. Switch off the appliance. Disconnect the mains plug.
2. Drain the detergent solution.
3. Pull the emergency release downwards with a tool and release. The washing machine door can then be opened.









## **Information on the display panel**





Display	Cause/remedial action
YES	The washing machine door is unlocked. It is possible to add laundry.
NO	<ul style="list-style-type: none"> <li>■ The temperature is too high. Wait until the temperature falls.</li> <li>■ Water level too high. Not possible to add laundry. If necessary, close the washing machine door immediately. To continue the programme, press <b>Start</b>/Pause .</li> </ul>
 flashes	<ul style="list-style-type: none"> <li>■ Laundry may be caught. Please open and close the washing machine door again and press <b>Start</b>/Pause .</li> <li>■ If necessary, push the washing machine door closed or remove the laundry and push it closed again.</li> <li>■ If necessary, switch the appliance off and on again; set the programme and make your individual settings; start the programme.</li> </ul>
E:17	<ul style="list-style-type: none"> <li>■ Turn the water tap on fully,</li> <li>■ The supply hose is kinked/trapped,</li> <li>■ The water pressure is too low. Clean the filter.</li> </ul>

## en Faults and what to do about them.

Display	Cause/remedial action
E:18	<ul style="list-style-type: none"> <li>■ The detergent solution pump is blocked. Clean the detergent solution pump.</li> <li>■ The drain hose/waste pipe is blocked. Clean the drain hose at the siphon.</li> </ul>
E:23	Water in the base tub, appliance leaking. Turn off the water tap. Call the after-sales service.
	The childproof lock is activated; to deactivate:
 flashes	Too much foam detected, a rinse cycle has been switched on.
:	The mains voltage is too low.
.	Undervoltage in the wash programme. The programme is extended.
Other displays	Switch off the appliance, wait for 5 seconds and switch it back on again. If the display appears again, call the after-sales service.

## Faults and what to do about them.

Faults	Cause/remedial action
Water is leaking out.	<ul style="list-style-type: none"> <li>■ Attach/replace the drainage hose correctly.</li> <li>■ Tighten the screw connection of the supply hose.</li> </ul>
No water supply. Detergent not dispensed.	<ul style="list-style-type: none"> <li>■ <b>Start/Pause</b>  not pressed?</li> <li>■ Tap not turned on?</li> <li>■ Filter blocked? Clean the filter.</li> <li>■ Supply hose kinked or trapped?</li> </ul>
Washing machine door cannot be opened.	<ul style="list-style-type: none"> <li>■ Safety function active. Programme stopped?</li> <li>■ ---  (Rinse hold = without final spin) selected?</li> <li>■ Can be opened by emergency release only?</li> </ul>
Programme does not start.	<ul style="list-style-type: none"> <li>■ <b>Start/Pause</b>  pressed or "<b>Ready in</b>" time selected?</li> <li>■ Washing machine door closed?</li> <li>■  Childproof lock activated? To deactivate:</li> </ul>
Detergent solution is not emptied.	<ul style="list-style-type: none"> <li>■ ---  (Rinse hold = without final spin) selected?</li> <li>■ Clean the detergent solution pump.</li> <li>■ Clean the waste pipe and/or drainage hose.</li> </ul>
Water not visible in the drum.	Not a fault – water below the visible area.
Spin result not satisfactory. Laundry wet/too damp.	<ul style="list-style-type: none"> <li>■ Not a fault – the unbalanced load detection system has interrupted the spin because the laundry is unevenly distributed. Distribute large and small items of laundry evenly in the drum.</li> <li>■  <b>Easy Iron</b> (depending on the model) selected?</li> <li>■ Speed selected too low?</li> </ul>
Spin cycle started and stopped several times.	Not a fault – the unbalanced-load detection system is adjusting the imbalance.

Faults	Cause/remedial action
The programme duration is longer than usual.	<ul style="list-style-type: none"> <li>■ Not a fault – the unbalanced-load detection system is adjusting the imbalance by repeatedly distributing the laundry.</li> <li>■ Not a fault – the foam detection system active – adds an additional rinse cycle.</li> </ul>
The programme duration changes during the wash cycle.	Not a fault – the programme sequence is optimised for the particular washing process. This may lead to changes in the programme duration in the display panel.
Residual water in the compartment  for care products.	<ul style="list-style-type: none"> <li>■ Not a fault – the effect of the care product is not affected.</li> <li>■ Clean the insert if necessary.</li> </ul>
Odours in the washing machine.	Run the  <b>Cottons 90 °C</b> programme without laundry. Use standard detergent.
The  symbol flashes in the display panel. Foam may escape from the detergent drawer.	<p>Too much detergent used?</p> <p>Mix one tablespoon of fabric softener with 1/2 litre water and pour into compartment <b>II</b> (not for outdoor fabrics, sportswear fabrics or those made with down).</p> <p>Reduce the detergent dosage for the next wash cycle.</p>
Intense noise, vibrations and "wandering" during spinning.	<ul style="list-style-type: none"> <li>■ Is the appliance levelled? Level the appliance.</li> <li>■ Are the appliance feet fixed? Secure the appliance feet.</li> <li>■ Transport locks removed? Remove the transport locks.</li> </ul>
Display panel/indicator lamps do not function during operation.	<ul style="list-style-type: none"> <li>■ Power cut?</li> <li>■ Circuit breakers tripped? Switch the circuit breakers back on or replace them.</li> <li>■ If the fault occurs repeatedly, call the after-sales service.</li> </ul>
Detergent residues on the laundry.	<ul style="list-style-type: none"> <li>■ Occasionally, phosphate-free detergents contain water-insoluble residues.</li> <li>■ Select  <b>Rinse</b> or brush the laundry after washing.</li> </ul>
<b>NO</b> appears on the display panel in reload mode.	<ul style="list-style-type: none"> <li>■ Water level too high. Not possible to add laundry. Close the washing machine door immediately, if necessary.</li> <li>■ To continue the programme, press <b>Start/Pause</b> .</li> </ul>
<b>YES</b> appears on the display panel in reload mode.	The washing machine door is unlocked. It is possible to add laundry.
The colon in the "Ready in" display (:) flashes on the display panel.	The mains voltage is too low.
The single dot (.) flashes.	The undervoltage has caused the wash programme to be extended.
<p>If you cannot correct a fault yourself (after switching off/on) or a repair is required:</p> <ul style="list-style-type: none"> <li>■ Set the programme selector to <b>Off</b>. The appliance is switched off.</li> <li>■ Unplug the mains plug from the socket.</li> <li>■ Turn off the tap and call the after-sales service .</li> </ul>	



## After-sales service

If you cannot correct the fault yourself, (see section, Faults and what to do about them) → *Page 27*, please contact our after-sales service. → Cover page

We will always find an appropriate solution in order to avoid unnecessary visits by engineers.

Please give the after-sales service the product number (E no.) and the production number (FD) of the appliance.

E-Nr. _____	FD _____
Product number	Production number

You can find this information, \*depending on the model:

On the inside of the washing machine door\*/in the opened service flap\* and on the rear of the appliance.

### **Trust the expertise of the manufacturer.**

Contact us for assistance. By doing so, you will ensure that the repairs are carried out by trained service personnel using genuine spare parts.



## Consumption rates

### Energy and water consumption, programme duration and residual moisture for the main washing programmes

(approximate information)

Programme	Load	Energy consumption*	Water*	Programme duration*
Cottons 20 °C	8 kg	0,40 kWh	71 l	2 3/4 h
Cottons 40 °C	8 kg	1,10 kWh	71 l	2 3/4 h
Cottons 60 °C	8 kg	1,51 kWh	71 l	2 3/4 h
Cottons 90 °C	8 kg	2,39 kWh	82 l	2 3/4 h
Easy-Care 40 °C	4 kg	0,79 kWh	53 l	2 h
Mix 40 °C	3,5 kg	0,51 kWh	45 l	1 1/4 h
Delicate/Silk 30 °C	2 kg	0,21 kWh	36 l	3/4 h
Wool 30 °C	2 kg	0,22 kWh	42 l	3/4 h









Programme	Approximate information on the residual moisture**		
	WAK28 ...	WAK24 ...	WAK20 ...
	WM14K ...	WM12K ...	WM10K ...
	3TS ...	3TS ...	3TS ...
	max 1400 rpm	max 1200 rpm	max 1000 rpm
Cottons	48 %	53 %	62 %
Easy-Care	40 %	40 %	40 %
Delicate/Silk	30 %	30 %	30 %
Wool	45 %	45 %	45 %

\* The values may deviate from the stated values depending on the following factors: water pressure and hardness; water inlet temperature; ambient temperature; type, amount and soiling of laundry; type of detergent used; fluctuations in the power supply and additional functions selected.

\*\* Information on residual moisture based on programme-dependent spin speed limits and maximum loads.

## Efficiency test programmes for cotton fabrics

The following programmes (standard programmes, indicated by ) are suitable for cleaning normally soiled cotton fabrics and are the most efficient with respect to combined energy and water consumption.

Standard-Programs for Cotton under EU-Regulation 1015/2010	Load	Programme duration
Programme Cottons  + button  EcoPerfect 	8 kg	3 ¾ h
Programme Cottons  + button  EcoPerfect 	4 kg	3 ¾ h
Programme Cottons  + button  EcoPerfect 	4 kg	3 ¼ h

Programme setting for testing and energy labelling in accordance with Directive 2010/30/EU with cold water (15 °C).  
The programme temperature information is based on the temperature stated on the care label for the fabrics. The actual washing temperature may deviate from the stated programme temperature for energy-saving reasons.

## Technical data

### Dimensions:

850 x 600 x 590 mm

(Height x width x depth)

### Weight

63-83 kg (depending on model)

### Mains connection:

Mains voltage 220-240 V, 50 Hz

Nominal current 10 A

Nominal output 2300 W

### Water pressure:

100-1000 kPa (1-10 bar)

### Power consumption when switched off:

0.12 W

### Power consumption when ready for use (left-on mode):

1.49 W



## Positioning and connecting

### Included with the appliance

**Note:** Check the machine for transport damage. Never use a damaged machine. If you have a complaint, please contact the retailer from whom you purchased the appliance, or our after-sales service.

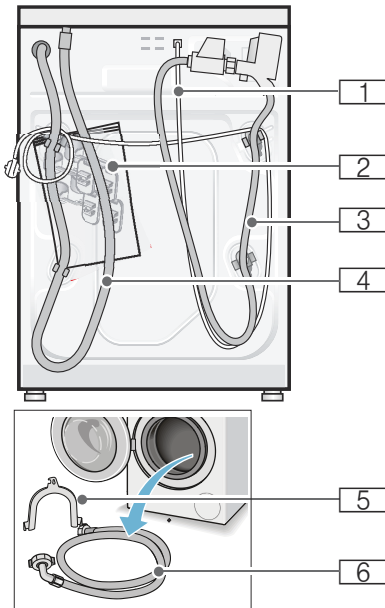

- 1 Mains cable
- 2 Bag:
  - Installation and operating instructions
  - After-sales service location directory\*
  - Warranty\*
  - Cover caps for openings left after removing the transport locks
  - Wrench\*
- 3 Water supply hose on Aqua-Stop models
- 4 Water drain hose
- 5 Elbow for securing the water drain hose\*

- 6 Water supply hose on standard/Aqua-Secure models  
\*depending on the model

**In addition,** a hose clamp ( 24 - 40 mm diameter, available from specialist dealers) is required to connect the water drain hose to a siphon.

### Useful tools

- Spirit level for levelling
- Wrench with:
  - WAF 13 for loosening the transport locks, and
  - WAF 17 for aligning the appliance feet

### Safety instructions

#### **Warning** **Risk of injury!**

- The washing machine is very heavy. Be careful when lifting/transporting the washing machine.
- When the washing machine is lifted by its protruding parts (e.g. the washing machine door), the components may break off and cause injuries. Do not lift the washing machine by protruding parts.
- If the hose and mains cables are not routed properly, there is a risk of tripping and injury. Lay hoses and cables in such a way that there is no risk of tripping.

#### **Caution!**

#### **Damage to the appliance**

Frozen hoses may rip/burst. Do not install the washing machine in areas exposed to frost or outdoors.

#### **Caution!** **Water damage**

The connection points for the water supply hose and water drain hose are under high water pressure. To prevent

## en Positioning and connecting

leaks and water damage, you must follow the instructions in this section.

### Notes

- In addition to the safety information listed here, the local water and electricity supplier may have special requirements.
- If in doubt, have the appliance connected by a specialist.

## Installation surface

**Note:** The washing machine be stable so that it does not move around.

- The installation surface must be firm and level.
- Soft floors/floor coverings are not suitable.

## Installation on a base or a wooden joist floor

### Caution!

#### Damage to the appliance

The washing machine may "wander" and tip/topple from the base when spinning.

The feet of the appliance must be secured with holding brackets.

Order no. WMZ 2200, WX 9756, Z 7080X0

**Note:** On wooden joist floors, install the washing machine:

- In a corner, if possible,
- On a water-resistant wooden board (min. 30 mm thick) which is screwed tightly to the floor.

## Installing the appliance in a kitchenette

### Warning Danger of death!

There is a risk of electric shock if you touch live components.

Do not remove the appliance covering plate.

### Notes

- Recess width of 60 cm required.
- Only install the washing machine underneath a continuous worktop that is securely connected to adjacent cabinets.

## Removing the transport locks

### Caution!

#### Damage to the appliance

- The machine is secured for transportation using transport locks. If the transport locks are not removed, the drum, for example, may become damaged when the machine is operated. Before using the appliance for the first time, make sure that you completely remove all four transport locks. Keep the locks in a safe place.
- To prevent transport damage from occurring if the appliance is moved at a later date, you must refit the transport locks before transporting the appliance.

**Note:** Keep the screws and sleeves in a safe place.

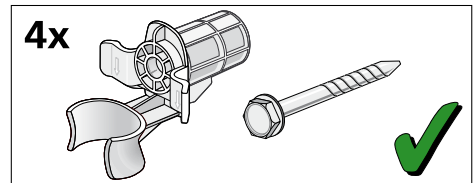

1. Take the hoses out of the holders.

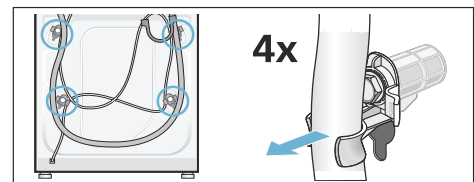

2. Unscrew and remove all four transport brace screws. Remove the sleeves. To do this, remove the mains cable from the holders.

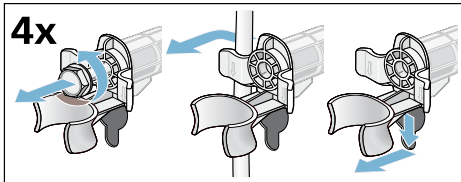

3. Fit the covers. Lock the covers firmly in place by applying pressure to the snap-in hooks.

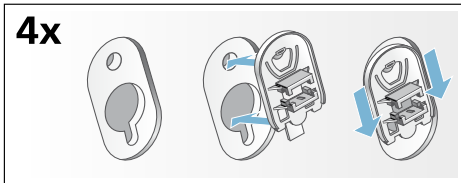

## Hose and cable lengths

- Left-hand connection

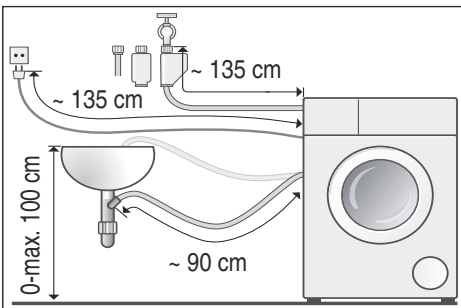

- Right-hand connection

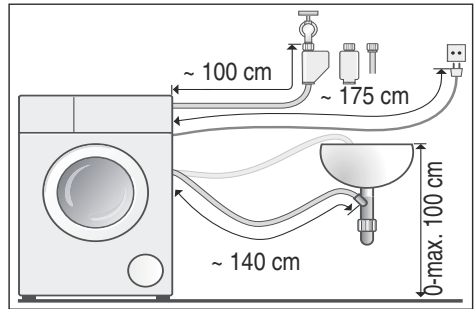

**Tip:** The following are available from specialist dealers/the after-sales service:

- An extension for Aqua-Stop or cold water supply hose (approx. 2.50 m); order no. WMZ2380, WZ10130, CZ11350, Z7070X0
- A longer supply hose (approx. 2.20 m) for standard model

## Water inlet

### **⚠ Warning** **Danger of death!**

There is a risk of electric shock if you touch live components. Do not immerse the Aqua-Stop safety valve in water (it contains an electric valve).

Observe the following when connecting the machine:

### Notes

- Only operate the washing machine using cold mains water.
- Do not connect the machine to the mixer tap of an unpressurised hot-water boiler.
- Do not use a used supply hose. Only use the supply hose supplied or one that was purchased from an authorised specialist retailer.
- Do not bend, squash, modify or cut through the water supply hose (otherwise its strength is no longer guaranteed).

## en Positioning and connecting

- Only tighten the screw connections by hand. If the screw connections are tightened too much with a tool (pliers), the thread may be damaged.

### Optimum water pressure in the supply network

**At least** 100 kPa (1 bar)

**Maximum** 1000 kPa (10 bar)

When the tap is open, the water flow is at least 8 l/min.

If the water pressure is higher than this, a pressure-reducing valve must be installed.

### Connection

Connect the water supply hose to the water tap ( $\frac{3}{4}$ " = 26.4 mm) and to the appliance (not necessary for Aqua-Stop models as this is permanently installed):

- Model: **Standard**

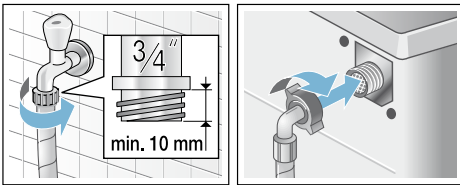

- Model: **Aqua-Secure**

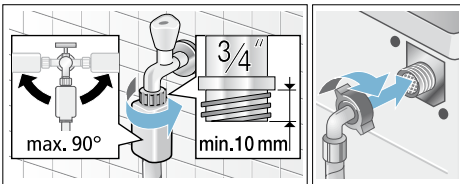

- Model: **Aqua-Stop**

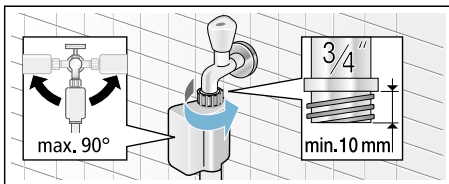

**Note:** Open the water tap carefully, checking the leak tightness of the connection points. The screw connection is under mains water pressure.

## Water outlet

### Caution!

#### Water damage

If the drain hose slips out of the wash basin or the connection point during draining due to high water pressure, any escaping water may cause water damage.

Secure the drain hose so that it cannot slip out.

**Note:** Do not kink the water drain hose or put strain on it lengthways.

You can lay the water drain hose as follows:

- **Outlet in a sink**

#### **Warning** **Risk of scalding!**

When you are washing at high temperatures, there is a risk of scalding if you come into contact with hot detergent solution e.g. if hot detergent solution is being drained into a wash basin.

Do not reach into the hot detergent solution.

#### Caution!

#### Damage to the appliance/fabrics

If the end of the drain hose is immersed in the drained water, water may be sucked back into the appliance and may damage the appliance/fabrics.

Make sure that:

- The plug does not block drainage from the sink.
- The end of the drain hose is not immersed in the drained water.
- The water drains away quickly enough.

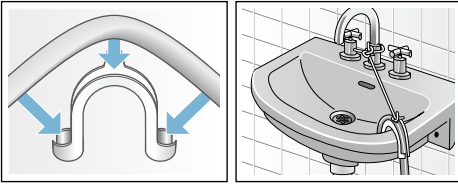

### ■ Drainage into a siphon

The connection point must be secured using a hose clamp with a diameter of 24-40 mm (available from specialist dealers).

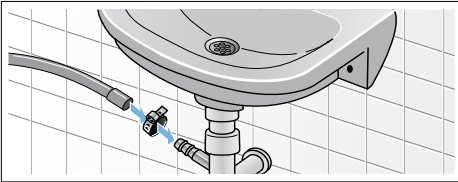

### ■ Outlet into a plastic pipe with rubber bushing or into a drainage pit

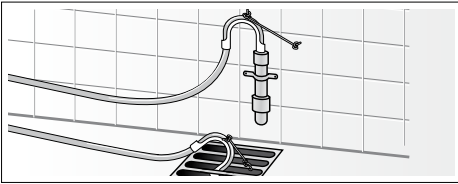

## Levelling

Level the appliance using a spirit level. Incorrect levelling may result in intense noise, vibrations and "wandering".

1. Loosen the lock nuts using a wrench, by turning it in a clockwise direction.
2. Check the alignment of the washing machine with a spirit level, and adjust it if necessary. Change the height by turning the appliance feet. All four appliance feet must stand firmly on the ground.
3. Tighten the lock nut against the housing.  
In doing so, hold the foot tight and do not adjust its height. The lock nuts on all four appliance feet must be screwed tightly against the housing.

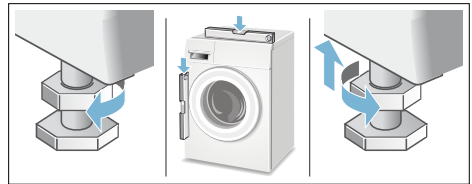

## Electrical connection

### Warning

#### Danger of death!

There is a risk of electric shock if you touch live components.

- Never touch or hold the mains plug with wet hands.
- Only pull out the mains cable by the plug and never by the cable, as this could damage it.
- Never unplug the mains plug during operation.

Observe the following information and ensure that:

#### Notes

- The mains voltage and voltage indicated on the washing machine (rating plate) are the same. The connected load and fuse required are specified on the rating plate.
- The washing machine is only connected to an alternating current via a properly installed earthed socket.
- The mains plug fits the socket.
- The cable cross-section is adequate.
- The earthing system is properly installed.
- The mains cable is only replaced by a qualified electrician (if this is necessary). Replacement mains cables are available from the after-sales service.
- No multiple plugs/couplings or extension cables are used.
- If an earth-leakage circuit breaker is used, only a type which displays this symbol is used: . Only this symbol guarantees compliance with the currently applicable regulations.
- The mains plug can be accessed at all times.
- The mains cable is not bent, squashed, modified, cut through, or in contact with heat sources.

## Before washing for the first time

The washing machine was thoroughly tested before leaving the factory. In order to remove any water which may be left over from the test, run the first washing cycle **without** any laundry.

#### Notes

- The washing machine **must be correctly installed and connected**. From → *Page 33*
  - Never use a damaged machine. Inform your after-sales service.
1. Check the machine.
  2. Remove the protective film from the control panel.
  3. Connect the mains plug.
  4. Turn on the water tap.
  5. Close the washing machine door (do not load any laundry).
  6. Select the  **Cottons** programme and set the temperature to **90 °C**.
  7. Open the detergent drawer.
  8. Pour approx. 1 litre of water into compartment **II**.
  9. Pour standard detergent into compartment **II**.  
**Note:** To prevent foaming, only use half of the amount of detergent recommended by the detergent manufacturer. Do not use detergent for wool or delicates.
  10. Close the detergent drawer.
  11. Press **Start**.
  12. Switch off the appliance at the end of the programme.
- Your washing machine is now ready to use.**

## Transportation

e.g. when moving home

### Preparatory work:

1. Turn off the water tap.
2. Reduce the water pressure in the supply hose.  
Maintenance – filter in the water supply → *Page 25*
3. Drain the remaining detergent solution.  
Maintenance – detergent solution pump blocked → *Page 24*
4. Disconnect the washing machine from the mains.
5. Remove the hoses.

### Installing the transport locks:

1. Remove the covers and keep them in a safe place.  
Use a screwdriver if necessary.

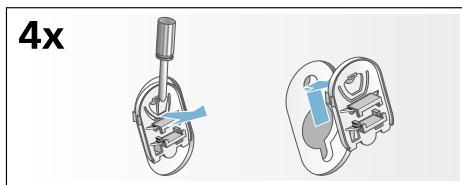

2. Insert all four sleeves.  
Clip the mains cable securely in the holders. Insert and tighten the screws.

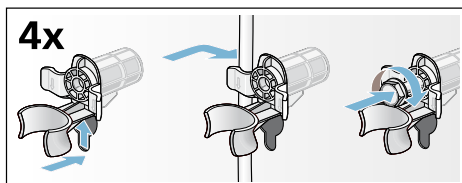

### Before initial use:

#### Notes

- The transport locks **must** be removed.
- To prevent unused detergent from flowing straight into the drain during the next wash: Pour approximately 1 litre of water into compartment **II** and select and start the  **Empty** programme.

## **Aqua-Stop warranty**

Only for appliances with Aqua-Stop

In addition to warranty claims against the vendor based on the purchase agreement and to our appliance warranty, we will provide compensation under the following conditions:

1. If water damage is caused due to a fault in our Aqua-Stop system, we will compensate domestic customers for the damage caused.
2. The liability guarantee is valid for the service life of the appliance.
3. It is a prerequisite of all warranty claims that the appliance with Aqua-Stop must have been installed and connected correctly in accordance with our instructions; this also includes a correctly fitted Aqua-Stop extension (genuine accessories).

Our warranty does not cover defective feed lines or fittings leading to the Aqua-Stop connection at the tap.

4. Appliances with Aqua-Stop do not need to be supervised during operation, nor secured afterwards by turning off the tap.  
The tap only needs to be turned off if you are away from home for a long period, e.g. for several weeks' holiday.



### **Advice and repair order in the event of faults**

GB 0344 892 8979 (Calls charged at local or mobile rate.)

IE 01450 2655 (0.03 € per minute at peak. Off peak 0.0088 € per minute.)

You can find the contact information for all countries in the attached after-sales service directory.

Robert Bosch Hausgeräte GmbH  
Carl-Wery-Straße 34  
81739 München, GERMANY



9001050382 (9512)